

Table of Contents

	Page(s)
Abbreviation definitions	38
Core listing (by application)	47-211
Core listing (by dimension)	212-340
Core listing (by model number)	341-378
Core types (fin pictures/brief descriptions)	3-4
Core types (fin pictures/detailed descriptions)	6-18
Core types (quick thickness views)	22
Header gasket listing (pre-fitted gaskets and rolls of gasket)	39-46
Header shapes	23-24
Header templates	25-29
Measuring (decimals-to-fractions chart)	36
Measuring instructions (bolt-on headers)	30-33
Measuring instructions (core)	19-21
Measuring instructions (crank box)	34
Measuring instructions (fins per inch)	35
Order form	37
Plant and Branch locations	379
Plant capabilities (core type, size and material)	5a, 5b
Warranty statement	2



Vista-Pro Automotive Limited Warranty

Vista-Pro Automotive warrants its products to be free from defects in material and workmanship for 12 months from date of shipment to the original consumer purchaser. This warranty covers any parts furnished from Vista-Pro Automotive's factory but does not include labor of any kind and materials not furnished by Vista-Pro Automotive or any charges for any such labor or materials.

The limited warranty is void if the product is subjected to misuse, negligence, or operating conditions other than those for which such equipment was designed, or has been repaired or altered outside the factory of Vista-Pro Automotive or when chemicals or any ingredients other than approved permanent-type antifreeze, designed and sold solely for radiator use, are used in the radiator. This warranty does not cover physical or chemical effects of any corrosive substances in the operating environment or the equipment. This warranty is extended to and enforceable by only the original purchaser.

VISTA-PRO AUTOMOTIVE'S WARRANTY OF ITS PRODUCTS TO BE FREE FROM ALL DEFECTS IN MATERIAL AND WORKMANSHIP, AS LIMITED HEREIN, AND SHALL BE IN LIEU OF AND EXCLUSIVE OF ALL OTHER WARRANTIES, WHETHER EXPRESS OR IMPLIED, INCLUDING WARRANTIES OF MERCHANTABILITY AND FITNESS FOR A PARTICULAR PURPOSE.

Claims for internal engine damage due to overheating will be denied. All vehicles and stationary equipment have warning lights and gauges to warn an operator of overheating conditions long before internal engine damage would occur. Vista-Pro Automotive shall not be responsible for engine damage due to operator negligence.

Purchaser's sole remedy for breach of this warranty, exclusive of all other remedies provided by law, shall be limited to repair or replacement of any part or parts which shall, within 12 months from date of shipment to the original consumer purchaser, be returned to the place of original purchases or to the Warranty Dept. of Vista-Pro Automotive, with all transportation expenses prepaid by purchaser, and which the examination by Vista-Pro Automotive or its designated agent, shall disclose to have been defective. Purchaser's remedy does not include reimbursement for any expenses incurred for labor or material charges incident to the replacement, removal or installation of any radiator, radiator core or component part, towing charges, rental of replacement vehicle, injuries to persons or property and any other special, incidental, consequential or punitive damages. An original/installation receipt is required to file a warranty claim.

VISTA-PRO AUTOMOTIVE IN NO EVENT SHALL BE LIABLE TO THE PURCHASER FOR DIRECT, INDIRECT, SPECIAL OR CONSEQUENTIAL DAMAGES OR LOSS OF PRODUCTION OR LOSS OF PROFITS OR CLAIMS OF THIRD PARTIES AGAINST THE PURCHASERS, RESULTING FROM ANY CAUSE WHATSOEVER, INCLUDING THOSE RESULTING FROM THE ORDER OR USE OF VISTA-PRO AUTOMOTIVE'S PRODUCTS, AND VISTA-PRO AUTOMOTIVE'S SOLE LIABILITY TO THE PURCHASER FOR ANY CAUSE OF ACTION, WHETHER BASED UPON NEGLIGENCE, CONTRACT OR STRICT LIABILITY, SHALL BE THE REPAIR OR REPLACEMENT REMEDY SET FORTH IN THE PRECEDING PARAGRAPH.



This warranty gives you specific legal rights, and you may also have other rights, which vary from state to state. Vista-Pro Automotive neither assumes nor authorizes any person to assume for it any obligation or liability other than as herein expressly stated.

Serpentine Fins



VT fin: 1/2" tube on 9/16" (.550) centerline

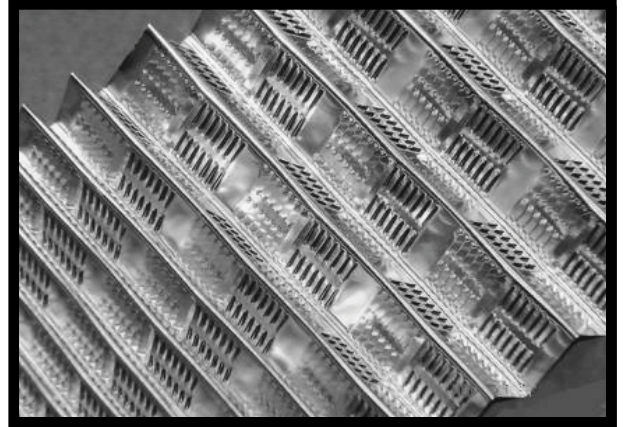

VE/HE fin: 3/8" tube on 3/8" (.413) centerline

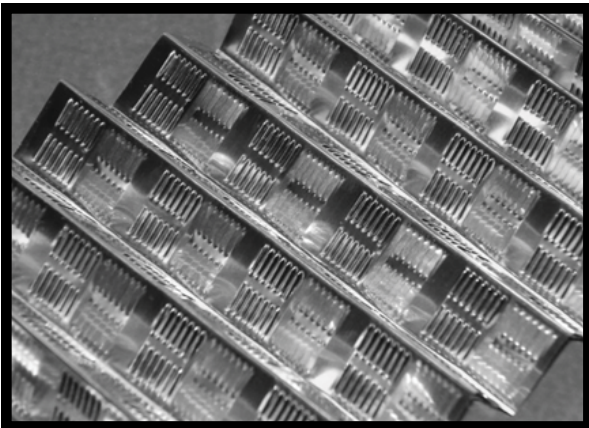

VTD fin: 5/8" tube on 9/16" (.570) centerline

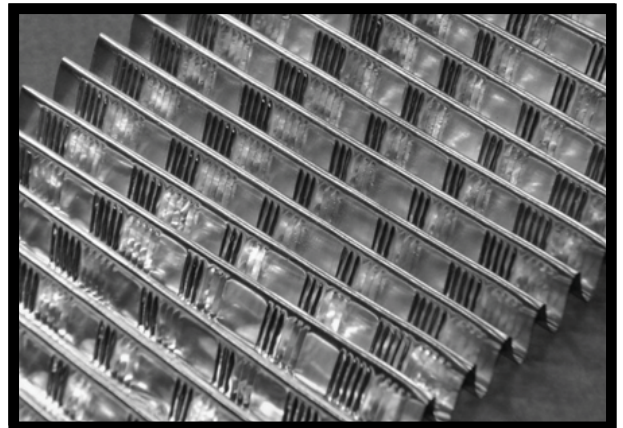

VH fin: 5/8" tube on 1/2" (.500) centerline



VTH fin: 5/8" tube on 7/16" (.421) centerline

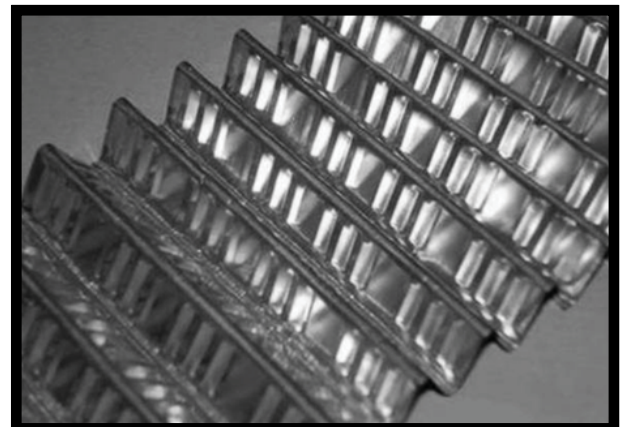

VTW fin: 1/2" tube on 9/16" (.550) centerline

Flat Fins

B fin:
1/2" tube
on 1/2"
(.500)
centers;
inline

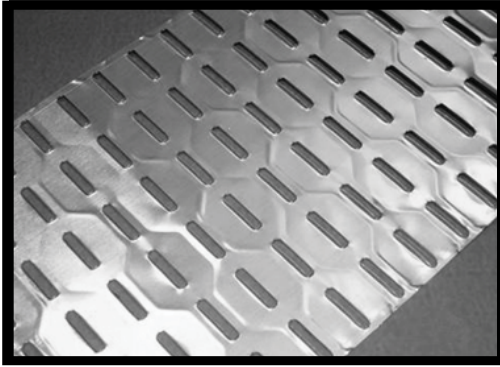

R fin:
1/2" tube
on 5/8"
(.625)
centers;
staggered,
louvered

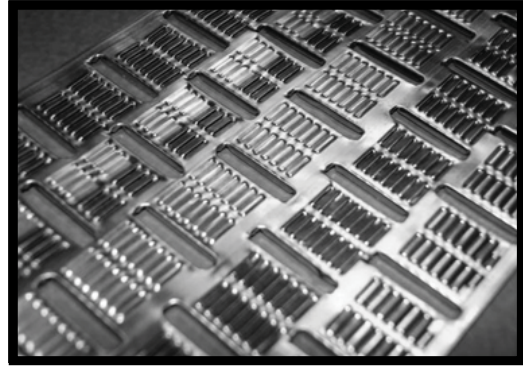

S fin:
1/2" tube
on 5/8"
(.625)
centers;
staggered

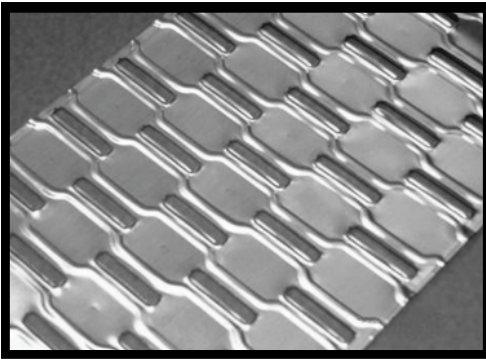

T fin: 1/2"
tube on
9/16"
(.562)
centers,
staggered

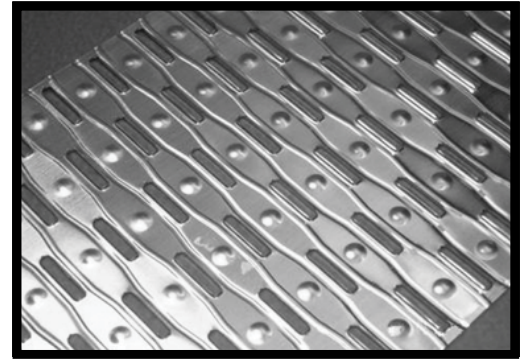

T-12 fin:
3/4" tube
on 7/16"
(.437)
centers;
staggered

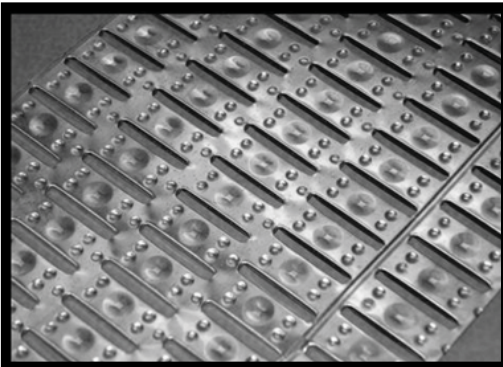

X fin:
3/4" tube
on 5/8"
(.625)
centers;
staggered

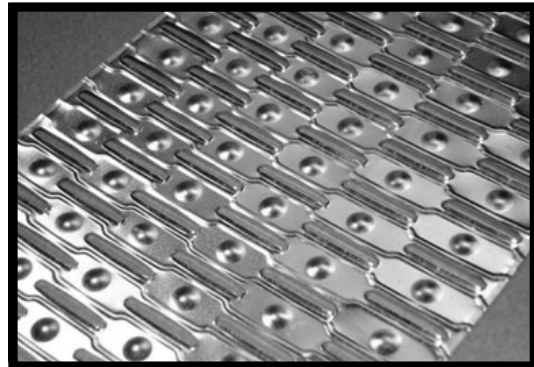

Z fin:
1/2" tube
on 5/8"
(.625)
centers;
canted

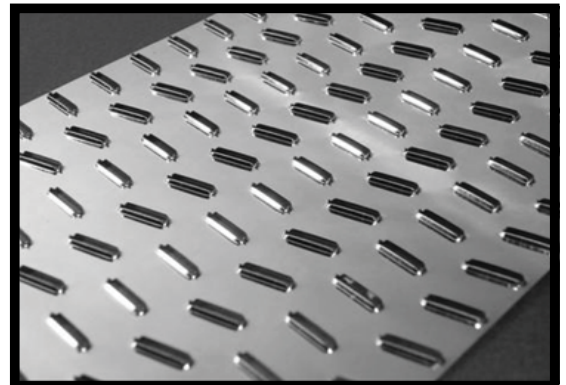

Regional Plant Capabilities

	B	X	R	S	T	T12	T16	XC or XS	Z	VE	VT	VH	VTD	VTH	VTW
Burr Ridge, IL	Brass	Copper	Copper	Copper	Brass			Brass	Copper	Copper	Copper			Copper	Copper
									Steel						
									Brass						
Cleveland, OH	Brass		Copper	Copper	Brass					Copper	Copper	Copper		Copper	Copper
	Copper				Copper										
	Steel				Steel										
Dallas, TX	Brass	Brass	Copper			Copper	Copper	Brass	Solder coated brass	Copper	Copper	Copper	Copper	Copper	Copper
	Solder coated brass	Solder coated brass		Brass	Brass			Solder coated brass	Steel						
				Solder coated brass	Solder coated brass				Brass						
Denver, CO	Brass	Brass	Copper	Copper	Brass						Copper			Copper	Copper
	Copper				Copper										
	Steel				Steel										
Orlando, FL	Brass		Copper	Copper					Brass		Copper			Copper	Copper
									Solder coated brass						
									Steel						
San Bernardino, CA	Copper		Copper	Copper	Copper			Copper	Copper	Copper	Copper	Copper		Copper	Copper
	Brass				Brass				Brass						
	Solder coated brass				Solder coated brass										
Seattle, WA	Steel	Copper			Steel				Steel						
	Copper		Copper	Copper	Copper					Copper	Copper			Copper	
	Brass				Brass										
Windsor, CT	Steel				Steel										
		Copper	Copper	Copper					Copper	Copper	Copper			Copper	
									Brass						
Tube size:	1/2"	3/4"	1/2"	1/2"	1/2"	3/4"	1/2"	3/4"	1/2"	3/8"	1/2"	5/8"	5/8"	5/8"	1/2"
Center line:	1/2"	5/8"	5/8"	5/8"	9/16"	7/16"	9/16"	5/8"	5/8"	3/8"	9/16"	1/2"	9/16"	7/16"	9/16"

Regional Plant Capabilities

	Lead Dip	NL Dip	Face Coat	Cat Jig	Maximum core size	CNC header punch
Burr Ridge, IL	X		X	X	72" x 72"	X
Cleveland, OH	X		X		61" x 60"	X
Dallas, TX	X	X	X	X	74" x 90"	X
Denver, CO	X		X		48" x 72"	X
Orlando, FL	X		X		59" x 59"	X
San Bernardino, CA	X		X	X	72" x 60"	X
Seattle, WA	X				52" x 52"	X
Windsor, CT	X				58" x 60"	X

Core Types

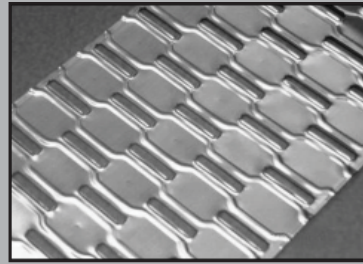
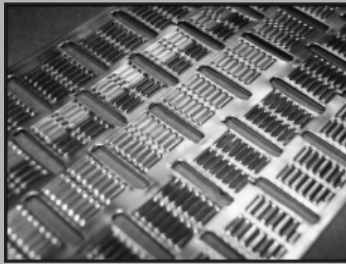
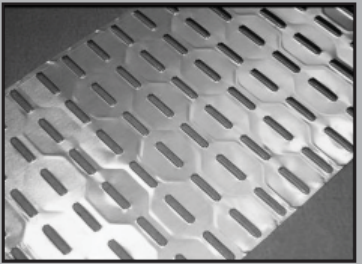
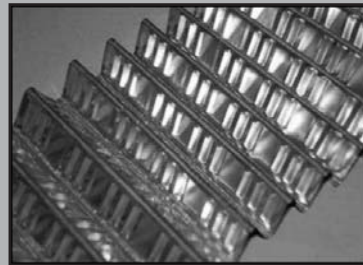
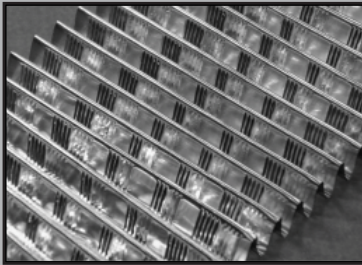
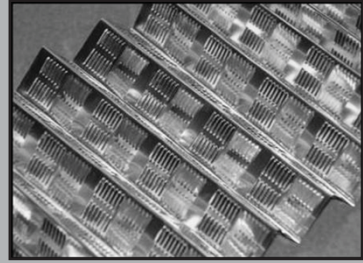
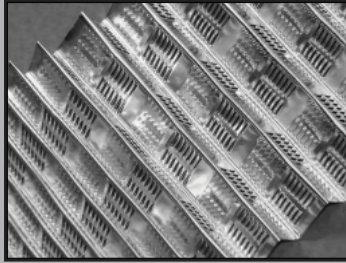

VT Core Type

Core Depth	Rows of Tubes	1/2" tubes on 9/16" (.550) centers; louvered serpentine	
1-1/4"	2	<ul style="list-style-type: none"> • Serpentine fin is designed primarily for automotive applications. • Multi-louvered fin is designed for maximum cooling. 	
2"	3		
2-5/8"	4		
FPI: 12,13,14,15,16		Available with: Fins: copper Tubes: 1/2" brass	Headers: brass Grooved and radius Bucket headers Ribbed headers Double fold headers

Plants: Burr Ridge, IL; Cleveland, OH; Dallas, TX; Denver, CO; Orlando, FL; San Bernardino, CA; Seattle, WA; Windsor, CT

VT Fin
(serpentine and louvered)



VE Core Type

Core Depth	Rows of Tubes	3/8" tubes on 3/8" (.413) centers; louvered serpentine	
1"	2	<ul style="list-style-type: none"> • Serpentine fin is designed primarily for automotive high-efficiency applications. • Excellent for high-performance applications. 	
1-9/16"	3		
2-1/4"	4		
2-3/4"	5		
FPI: 14,15,16, 17, 18		Available with: Fins: copper Tubes: 3/8" brass	Headers: brass Grooved and radius Bucket headers Ribbed headers Double fold headers

Plants: Burr Ridge, IL; Cleveland, OH; Dallas, TX; Denver, CO; Orlando, FL; San Bernardino, CA; Seattle, WA; Windsor, CT

VE/HE Fin

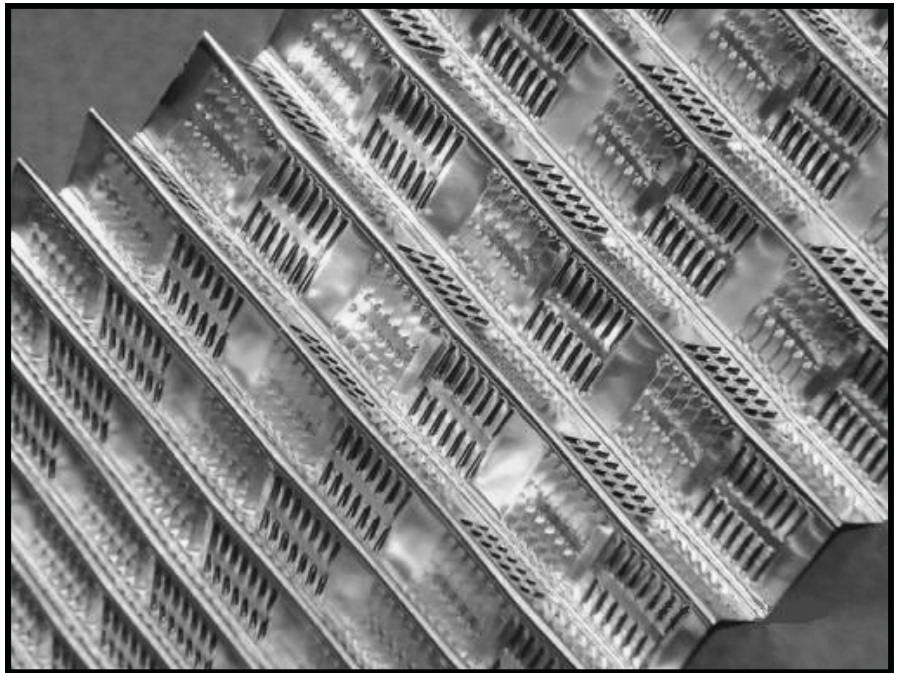

VTD (Ultra Fuse®) Core Type

Core Depth	Rows of Tubes	5/8" tubes on 9/16" (.570) centers; louvered serpentine	
1-1/2"	2	<ul style="list-style-type: none"> • Louvered and serpentine fin is designed for heavy duty truck applications using 5/8" tubes, either low-flow or high-flow tubes. • The VTD and VH fin types are OE truck type designed fins for maximum cooling. 	
2-1/4"	3		
3"	4		
3-3/4"	5		
FPI: 14,15,16		Available with: Fins: copper Tubes: 5/8" brass	Headers: brass Ultra-Fuse®: welded tube to header joints

Plant: Dallas, TX

VTD Fin

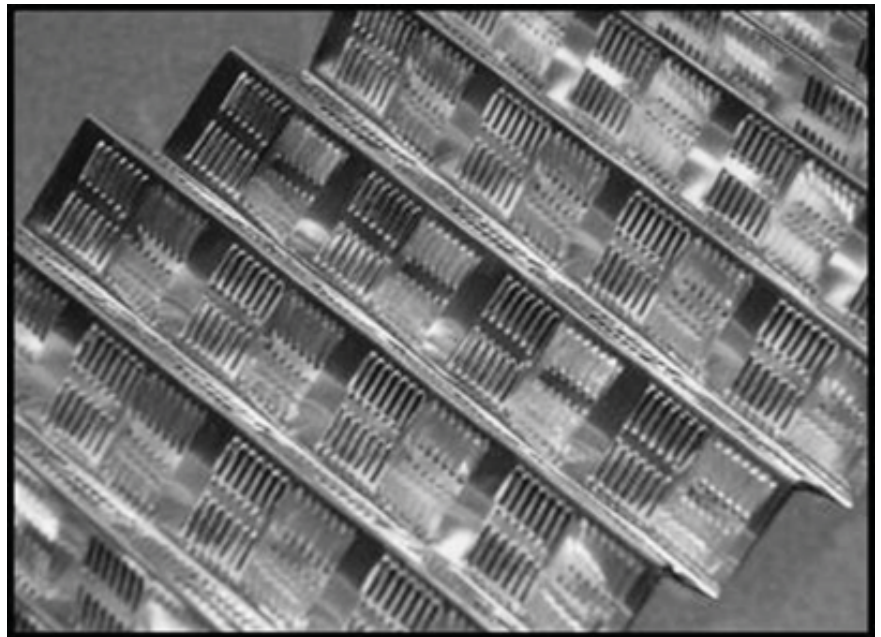

VH Core Type

Core Depth	Rows of Tubes	5/8" tubes on 1/2" (.500) centers; louvered serpentine
1-1/2"	2	
2-1/4"	3	
3"	4	
3-3/4"	5	
FPI: 14,15,16		Available with: Fins: copper Tubes: 5/8" brass Headers: Brass

Plants: Cleveland, OH; Dallas, TX; San Bernardino, CA

VH Fin

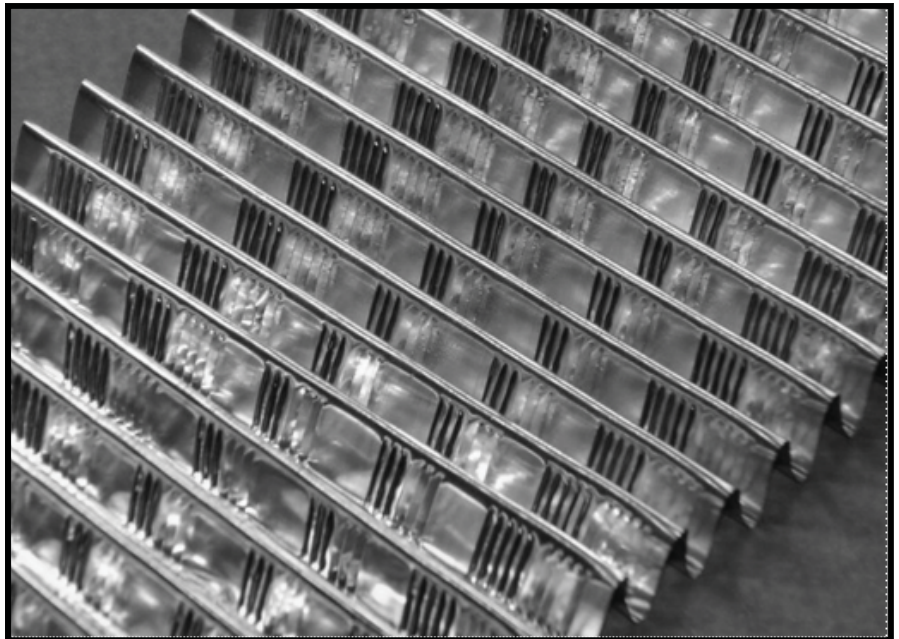

VTH Core Type

Core Depth	Rows of Tubes	5/8" tubes on 7/16" (.421) centers; louvered serpentine	
1-1/2"	2	<p>The VTH fin is a louvered serpentine core that incorporates a high-performance 5/8" tube with close tube centers. This is our best performing core (heat transfer) and most cost-effective core design. This core is designed to reduce core depth (number of tube rows) and maintain or increase thermal performance.</p>	
2-1/4"	3		
3"	4		
FPI: 14,15,16		<p>Available with: Fins: copper Tubes: 5/8" brass</p>	<p>Headers: brass Grooved and radius Bucket headers Ribbed headers Double fold headers</p>

Plants: Burr Ridge, IL; Cleveland, OH; Dallas, TX; Denver, CO; Orlando, FL; San Bernardino, CA; Seattle, WA; Windsor, CT

VTH Fin



VTW Core Type

Core Depth	Rows of Tubes	1/2" tubes on 9/16" (.550) centers; non-louvered serpentine	
1-1/4"	2	<p>The VTW is a non-clogging heavy duty fin design. The leading and trailing edge of this fin is hemmed (folded over) to increase stiffness and ease of maintenance. This durable fin design is used in various heavy duty applications including refuse trucks, industrial applications, specialty vehicles, farm equipment, etc.</p> <p>The VTW fin has a significant performance increase compared to traditional flat-fin designs and is quite cost effective.</p>	
2"	3		
2-5/8"	4		
3-1/4"	5		
4"	6		
FPI: 8, 9, 10		<p>Available with: Fins: copper Tubes: 1/2" brass</p>	<p>Headers: brass Grooved and radius Bucket headers Ribbed headers Double fold headers</p>

Plants: Burr Ridge, IL; Cleveland, OH; Dallas, TX; Denver, CO; Orlando, FL; San Bernardino, CA

VTW Fin

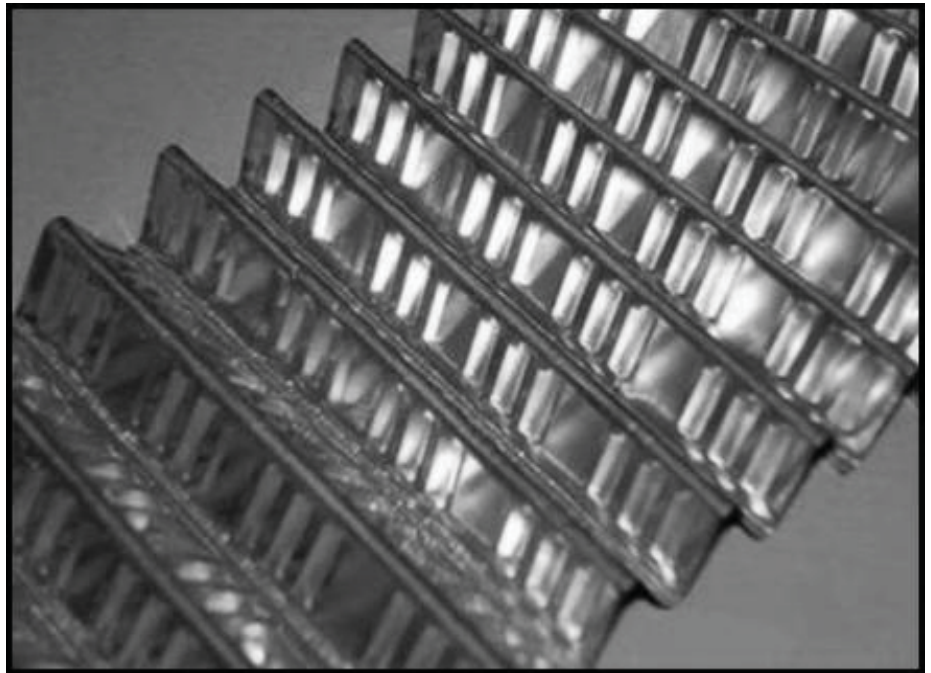

B Core Type

Core Depth	Rows of Tubes	1/2" tubes on 1/2" (.500) centers; inline construction, non-louvered
1-1/2"	2	
2-1/4"	3	Used in off-road applications where fin clogging is a problem (<i>i.e.</i> , cotton gins, some logging operations). Inline construction allows for ease of clean-out. Not recommended for use with turbocharged engines with high fan speeds. Especially popular around cotton gins/fields and paper mills and is available in very low fin count, down to 4 fins per inch. Excellent for feed lot applications.
3"	4	
3-3/4"	5	
4-1/2"	6	
5-1/4"	7	
6"	8	Available with: Fins: steel, copper, brass; *No-lead face spray in some locations; *Solder coated fins; Tubes: 1/2" brass Headers: brass, grooved and radius, bolted; Pan headers; *Corner: full braces; Special construction: crank box; *Brazed construction; *Steel side; *Tube guards (on 7 and 8 FPI); Cat tie bars and steel center fins
FPI: 6, 7, 8, 9, 10, 11		

Plants: Burr Ridge, IL; Cleveland, OH; Dallas, TX; Denver, CO; Orlando, FL; San Bernardino, CA; Seattle, WA

B Fin

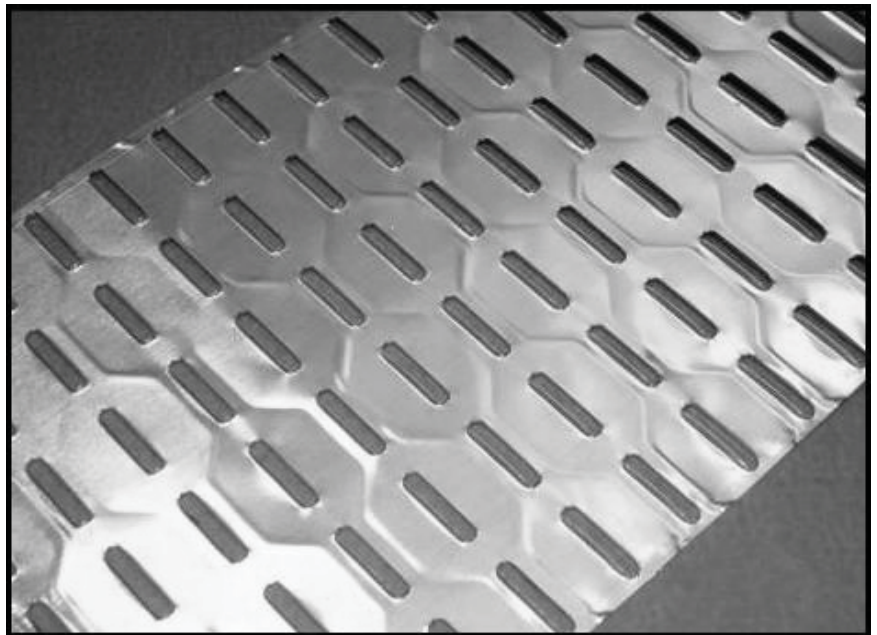

R Core Type

Core Depth	Rows of Tubes	1/2" tubes on 5/8" (.625) centers; staggered, louvered
1-1/4"	2	
1-3/4"	3	Excellent cooling capability primarily designed for highway truck applications. Also popular with stationary generator cooling units and other applications where maximum cooling is needed and clogging is not a problem. These louvers are designed for extra cooling.
2-3/8"	4	
2-7/8"	5	
3-7/16"	6	
3-15/16"	7	
4-1/2"	8	Available with: Fins: copper; Tubes: 1/2" brass Headers: brass, grooved and radius, bolted; Pan headers; *Corner: full braces; Special construction: crank box; *Braze construction; *Steel side; *LeMaster Adapter Assembly
FPI: 6, 7, 8, 9, 10, 11		

Plants: Burr Ridge, IL; Cleveland, OH; Dallas, TX; Denver, CO; Orlando, FL; San Bernardino, CA; Seattle, WA; Windsor, CT

R Fin

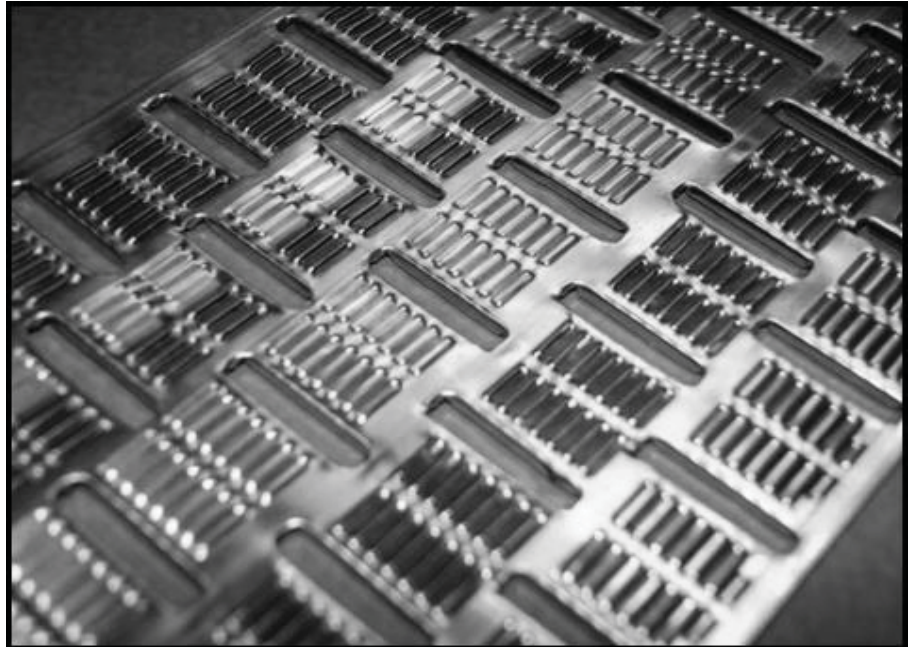

S Core Type

Core Depth	Rows of Tubes	1/2" tubes on 5/8" (.625) centers; staggered, non-louvered
1-1/4"	2	
1-3/4"	3	Excellent general purpose fin. Same design as R fin but without louvered fins. Used for tractors and when there is a need for a lot of tubes in a narrow width. Spacing is designed to allow more rows of tubes per core depth. Can be used in heavier applications than the R type due to the elimination of louvers.
2-3/8"	4	
2-7/8"	5	
3-7/16"	6	
3-15/16"	7	
4-7/16"	8	Available with: Fins: copper, brass; * Solder coated brass; Tubes: 1/2" brass
FPI: 6, 7, 8, 9, 10, 11		

Plants: Burr Ridge, IL; Cleveland, OH; Dallas, TX; Denver, CO; Orlando, FL; San Bernardino, CA; Seattle, WA; Windsor, CT

S Fin

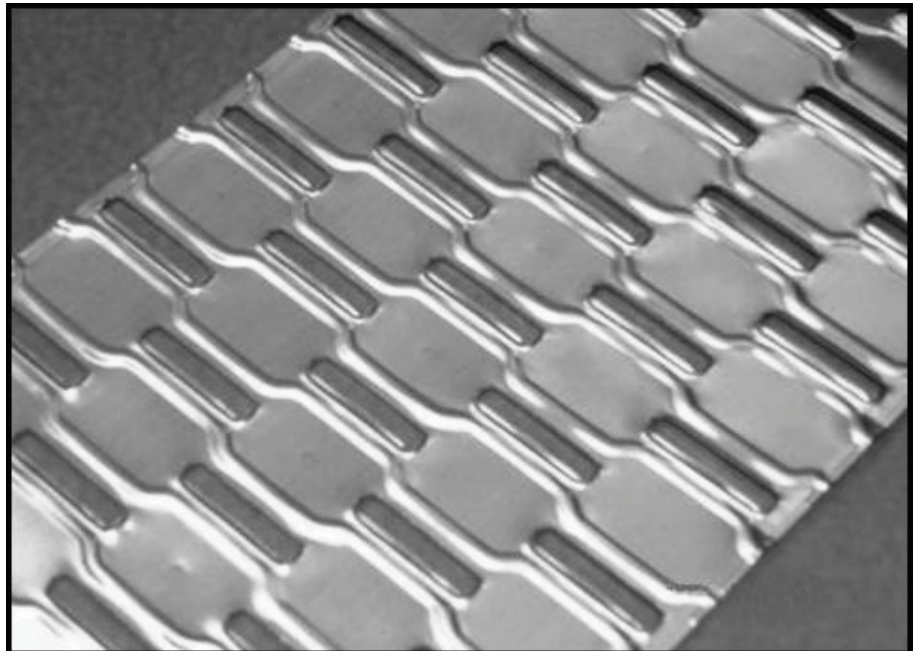

T Core Type

Core Depth	Rows of Tubes	1/2" tubes on 9/16" (.562) centers; staggered, non-louvered
1-1/2"	2	
2-1/4"	3	Excellent general purpose fin configuration used in off-road and on-road applications. Works well in agricultural/tractor applications, dozers, gen sets, dozers (Cat), loaders and many Detroit Diesel applications. Also used in fork lifts, loaders and stationary engine environments.
3"	4	
3-3/4"	5	
4-1/2"	6	
5-1/4"	7	
6"	8	Available with: Fins: copper, steel, brass; * Solder coated brass; Tubes: 1/2" brass Headers: brass, grooved and radius, bolted; Pan headers; *Corner: full braces; Special construction: crank box; *Braze construction; *Steel side; *Tube guards (7 and 8 FPI only); *LeMaster Adapter Assembly; Cat tie bars and steel center fins
FPI: 6, 7, 8, 9, 10, 11		

Plants: Burr Ridge, IL; Cleveland, OH; Dallas, TX; Denver, CO; San Bernardino, CA; Seattle, WA

T Fin

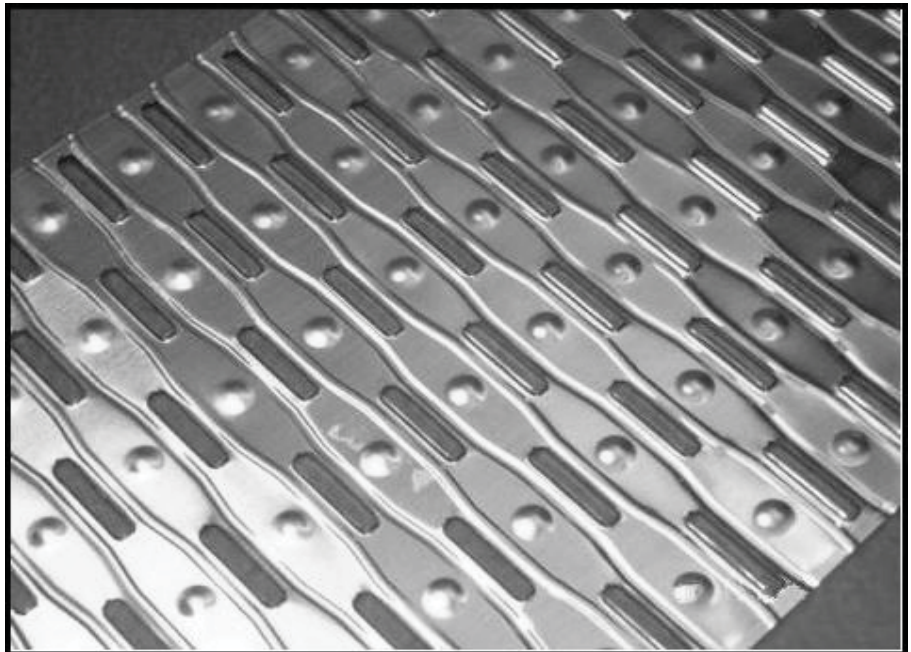

X Core Type

Core Depth	Rows of Tubes	3/4" tubes on 5/8" (.625) centers; staggered, non-louvered
1-7/8"	2	
2-1/4"	3	Excellent general purpose fin for applications requiring 3/4" tubes. Designed especially for farm, truck and industrial applications. Dimples and ribbing provide maximum cooling, yet promote free air flow to minimize clogging.
3"	4	
3-3/4"	5	
4-5/8"	6	
5-1/4"	7	A popular unit for offshore applications using regular brass or solder coated.
6-1/8"	8	
FPI: 6, 7, 8, 9, 10, 11		<p>Available with: Fins: copper, brass, solder coated brass; Tubes: 3/4" brass; Dimpled tubes N/A</p> <p>Headers: brass, grooved and radius, bolted; Pan headers; *Corner: full braces; No bucket headers; Special construction: crank box; *Steel side; *LeMaster Adapter Assembly; *Tube guards available with 7 and 8 FPI.</p>

Plants: Burr Ridge, IL; Dallas, TX; Denver, CO; San Bernardino, CA; Windsor, CT

X Fin

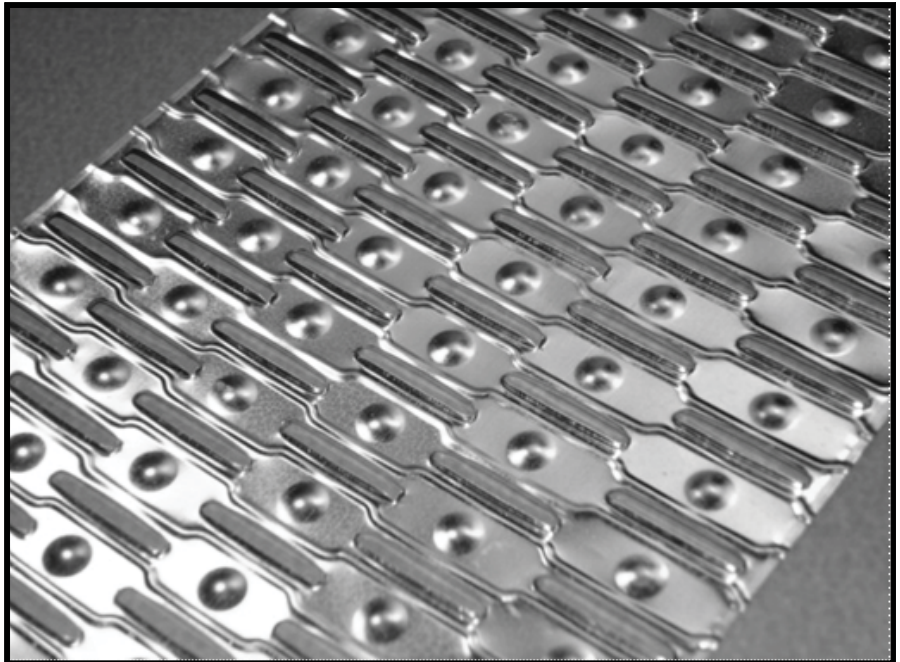

Z Core Type

Core Depth	Rows of Tubes	1/2" tubes on 5/8" (.625) centers; canted tubes (10 degree tube cant)
2-3/16"	3	
2-15/16"	4	General purpose fin for off-road and heavy duty use. Duplicates OEM appearance and quality. OEM design used on many popular dozer, loader and farm equipment applications. Excellent core for turbo-charged applications. Better cooling than inline or staggered fin design.
3-11/16"	5	
4-7/16"	6	
5-3/16"	7	
6	8	
FPI: 6, 7, 8, 9, 10, 11		Available with: Fins: copper, brass, solder coated brass, steel; Tubes: 1/2" brass
		Headers: brass, grooved and radius, bolted; Pan headers; *Corner: full braces; Special construction: crank box; *Brazed construction; *Steel side; *Tube guards (on 7 and 8 FPI); *LeMaster Adapter Assembly; Tie bars

Plants: Burr Ridge, IL; Dallas, TX; Orlando, FL; San Bernardino, CA; Windsor, CT

Z Fin

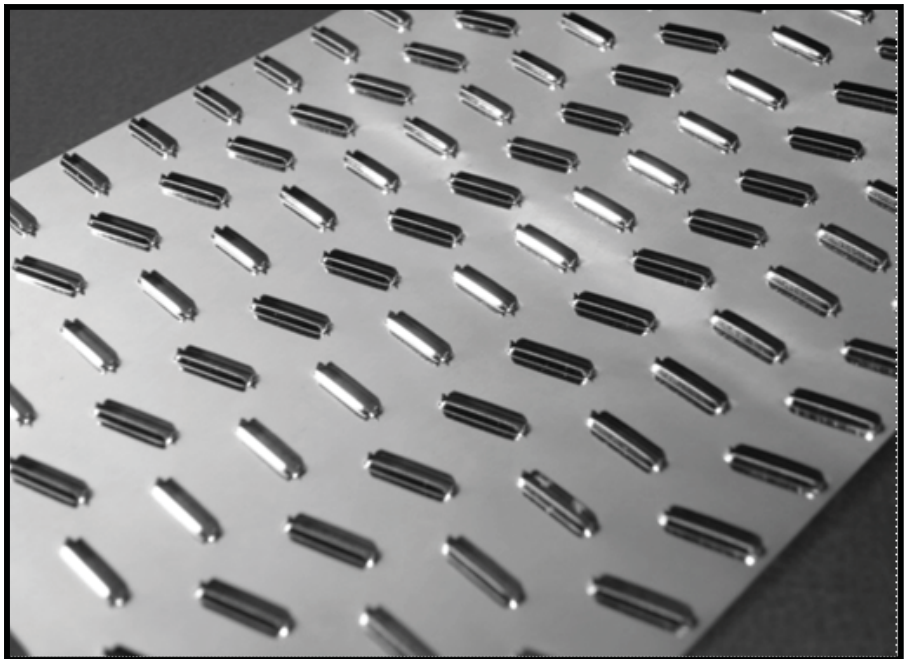

T-12 Core Type

Core Depth	Decimal to Fraction	Rows of Tubes	3/4" tubes on 7/16" (.437) centers; staggered, non-louvered
1.798"	1-3/4"	2	
2.668"	2-11/16"	3	Available in DALLAS ONLY. Specifically used when duplicating OE models with 3/4" tubes on 7/16 centers. Original locomotive design for high-capacity coolant flow. General design of core allows for an increased amount of water flow.
3.538"	3-9/16"	4	
4.408"	4-7/16"	5	
5.278"	5-1/4"	6	
6.148"	6-1/8"	7	Used when you're replacing a unit with a lot of tubes. Pricing quotes on request only.
7.018"	7"	8	Available with: Fins: copper; Tubes: 3/4" brass
FPI: 6, 7, 8, 9, 10, 11			Headers: brass, grooved and radius, bolted; Pan headers; *Corner: full braces; Special construction: crank box; *Steel sides; *Brazed construction and tube guards (on 7 and 8 FPI)

Plants: Available in Dallas, TX ONLY

T-12 Fin

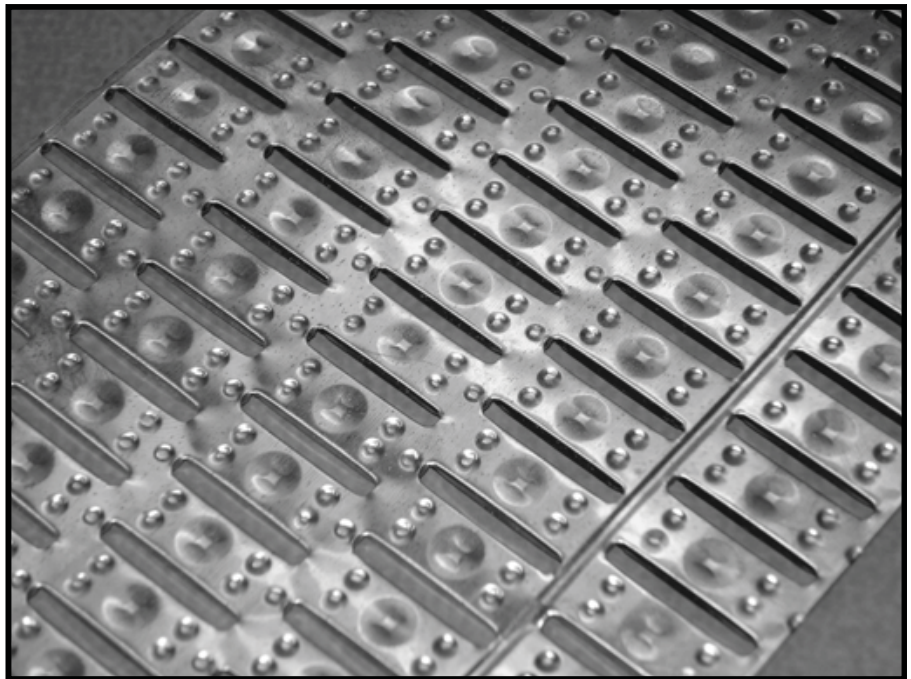



Measuring and Dimensions



Properly Measuring a Radiator Core

Core height

This is **ALWAYS measured between the headers**, regardless of whether the tanks are side-by-side (crossflow design) or top-to-bottom (downflow design).

Core width

The core width is taken across the face of the core, between the side support rails. **DO NOT** include the thickness of the side rails, only the **FIN CORE SURFACE** itself.

Core depth

This is best measured using a probe such as a wire coat hanger. Gently push it through the fins until it reaches the rear face, and use your fingers to “hold” the dimension of the wire that went into the core. Extract it carefully and measure it.

Important note:

If you're uncomfortable with measuring, or have a tough core to measure, consider shipping it (sample) to your nearest Vista Pro Automotive Regional Plant for measuring, or call us and ask one of our knowledgeable Customer Service Representatives to walk you through the measure.

For more help, see “Electronic Core Catalog” for more options, faster look-ups, bolt-hole, tank patterns, etc.

Use a Core Order Form and fax machine when needed. **Confirm measurements via fax and phone before you build.**

ALWAYS repeat your order back to your customer for confirmation.
Remember, measure twice, *build once.*

Core Measurement Guide

For ordering listed and special cores

A = height of core
B = width of core
C = depth of core
D = width of top header
E = length of top header

F = width of bottom header
G = length of bottom header
H = top header overhang
I = bottom header overhang
J = number of fins per inch

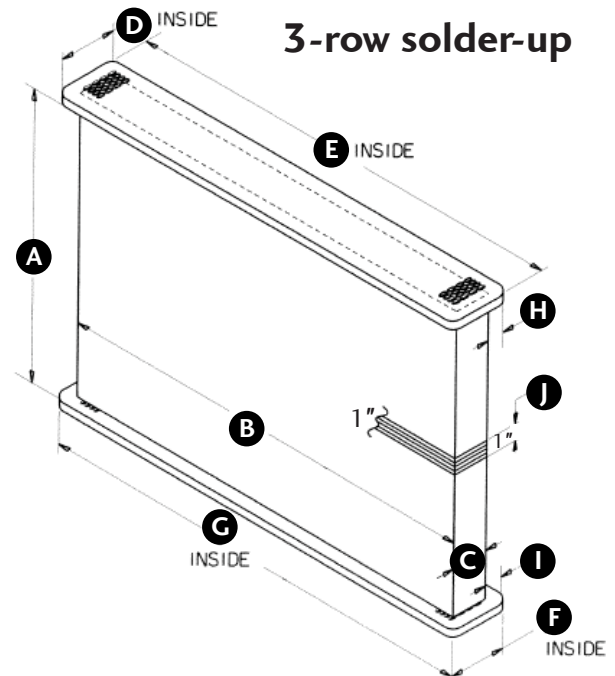
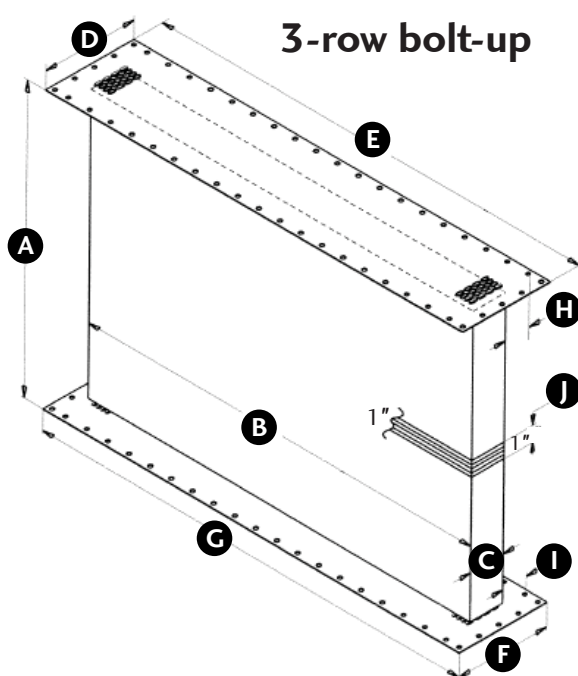

Additional information upon ordering

1 = number of bolt holes
2 = shape of headers
3 = material gauge of headers
4 = copper, brass or steel fin

1 = radius of header
2 = header style (formed, square, etc.)
3 = material gauge of headers
4 = copper, brass or steel fin

Core Dimensional Information

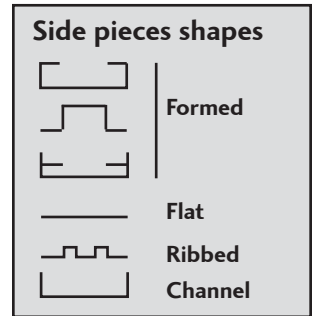
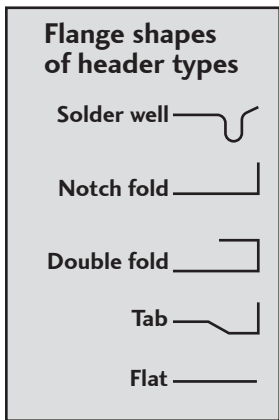
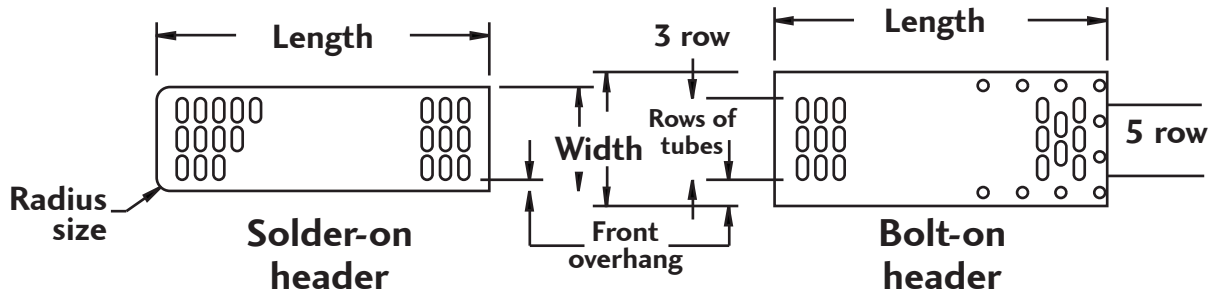

Height between headers

Fins per inch (FPI)

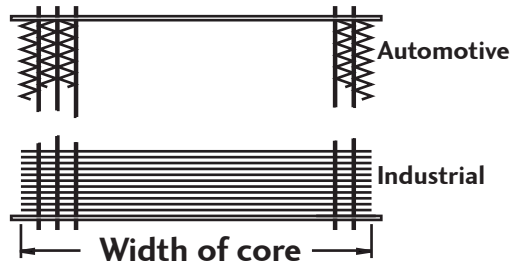
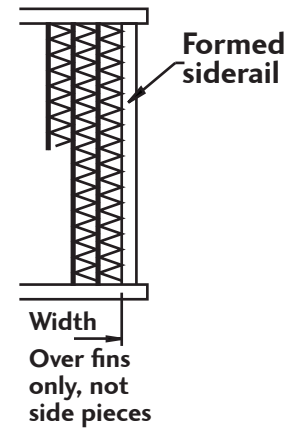
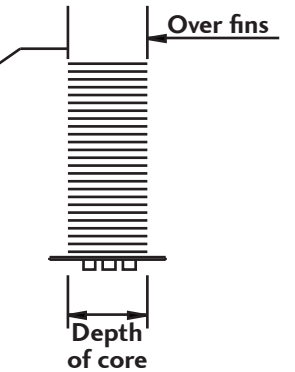
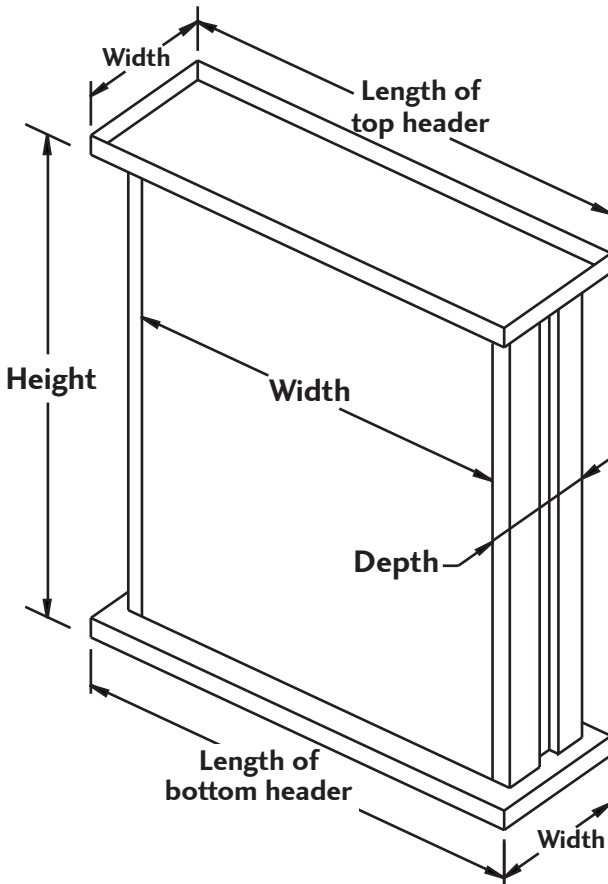
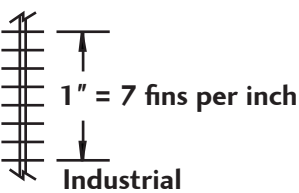
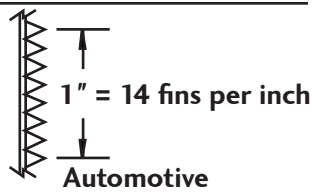

Fin Thickness: Quick Guide

"R" Fin Core 1/2" tubes on 5/8" centers staggered-louvered	
Rows	Depth
2	1-1/4"
3	1-3/4"
4	2-3/8"
5	2-7/8"
6	3-7/16"
7	3-15/16"
8	4-1/2"

"T" Fin Core 1/2" tubes on 9/16" centers staggered-non-louvered	
Rows	Depth
2	1-1/2"
3	2-1/4"
4	3"
5	3-3/4"
6	4-1/2"
7	5-1/4"
8	6"

"VTD" Fin Core 5/8" tubes on 9/16" centers louvered/serpentine core	
Rows	Depth
2	1-1/2"
3	2-1/4"
4	3"
5	3-3/4"

"S" Fin Core 1/2" tubes on 5/8" centers staggered-non-louvered	
Rows	Depth
2	1-1/4"
3	1-3/4"
4	2-3/8"
5	2-7/8"
6	3-7/16"
7	3-15/16"
8	4-1/2"

"X" Fin Core 3/4" tubes on 5/8" centers staggered-non-louvered	
Rows	Depth
2	1-7/8"
3	2-1/4"
4	3"
5	3-3/4"
6	4-5/8"
7	5-1/4"
8	6-1/8"

"VTW" Fin Core 1/2" tubes on 9/16" centers non-louvered/serpentine core	
Rows	Depth
2	1-1/4"
3	2"
4	2-5/8"
5	3-1/4"
6	4"

"Z" Fin Core 1/2" tubes on 5/8" centers canted-non-louvered	
Rows	Depth
3	2-3/16"
4	2-15/16"
5	3-11/16"
6	4-7/16"
7	5-3/16"
8	6"

"VH" Fin Core 5/8" tubes on 1/2" centers louvered/serpentine core	
Rows	Depth
2	1-1/2"
3	2-1/4"
4	3"
5	3-3/4"

"VT" Fin Core 1/2" tubes on 9/16" centers louvered/serpentine core	
Rows	Depth
2	1-1/4"
3	2"
4	2-5/8"

"B" Fin Core 1/2" tubes on 1/2" centers inline-non-louvered	
Rows	Depth
2	1-1/2"
3	2-1/4"
4	3"
5	3-3/4"
6	4-1/2"
7	5-1/4"
8	6"

"VTH" Fin Core 5/8" tubes on 7/16" centers louvered/serpentine core	
Rows	Depth
2	1-1/2"
3	2-1/4"
4	3"

"VE" Fin Core 3/8" tubes on 3/8" centers louvered/serpentine core	
Rows	Depth
2	1"
3	1-9/16"
4	2-1/4"
5	2-3/4"











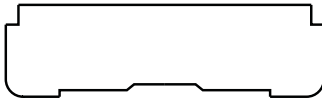

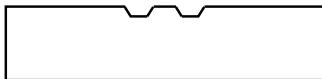
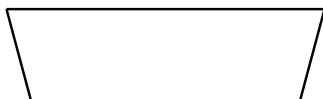
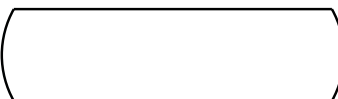
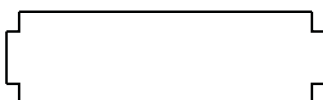
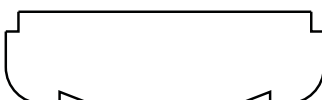

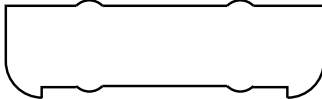
Old fins-per-inch Data Crossover Table (used in older catalogs)

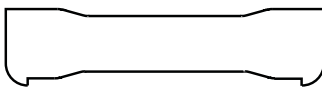
A-6; B-7; C-8; D-9; E-10; F-11; G-13; K-14; L-15; M-16; N-12; P-17; R-18; S-19; T-20; U-21; V-22

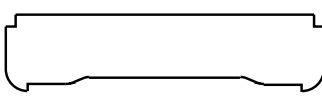

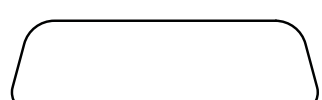



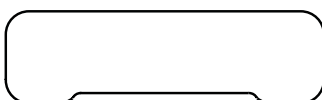







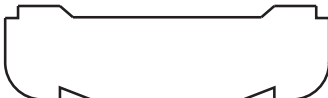

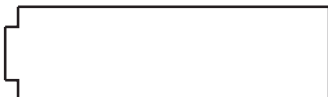
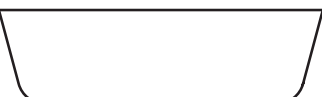

Header Shapes and Templates

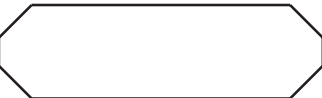
Outlines of Bolted Header Shapes

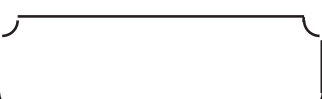
	A	K	
 Notched or rounded	B	L	
	C	M	
	D	N	
	E	O	
 Notched or rounded	F	P	
	G	Q	
	H	R	
	I	S	
	J	T	

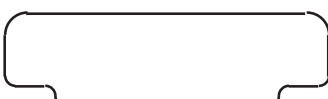
Outlines of Bolted Header Shapes

	U	EE	
	W	FF	
	X	GG	
	Y	KK	
	Z	LL	
	AA	NN	
	BB	SS	
	CC	XX	
	DD	ZZ	

Header Templates

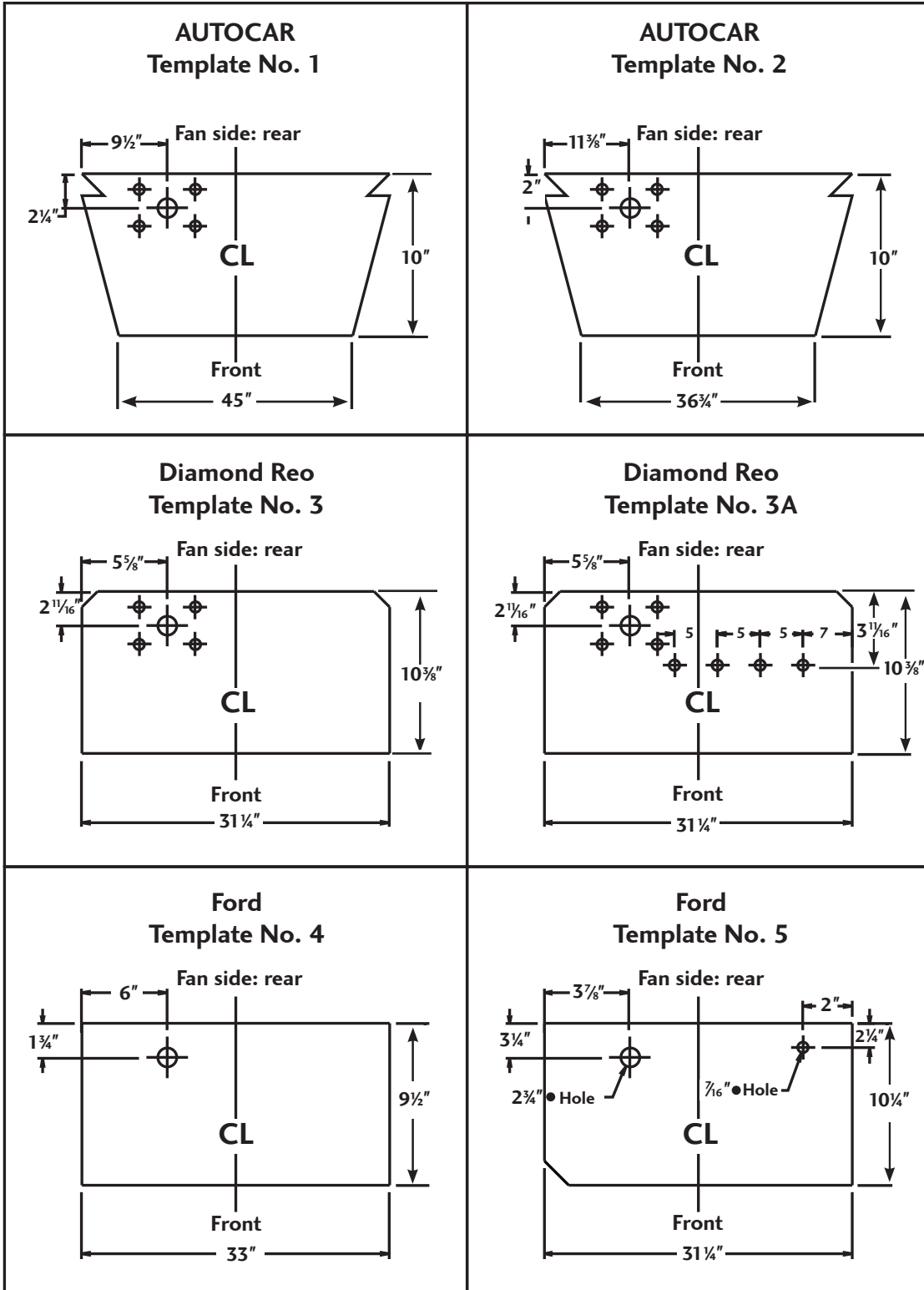

Header Templates

**Ford
Template No. 5A**

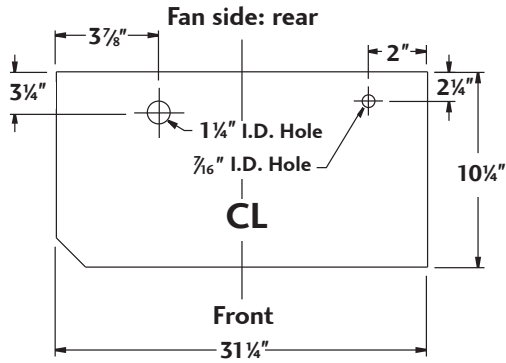

**Ford
Template No. 6**

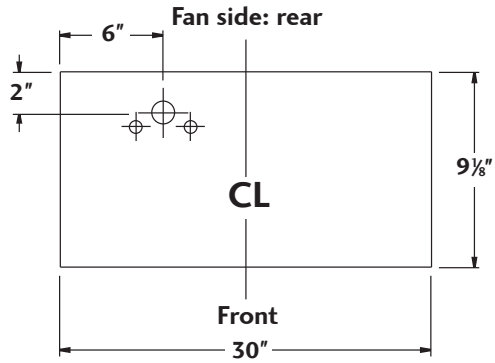

**Ford
Template No. 6A**

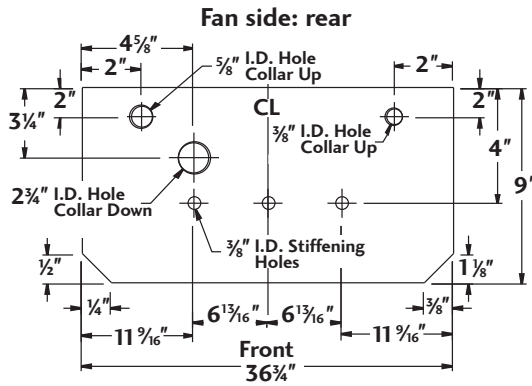

**Ford
Template No. 6B**

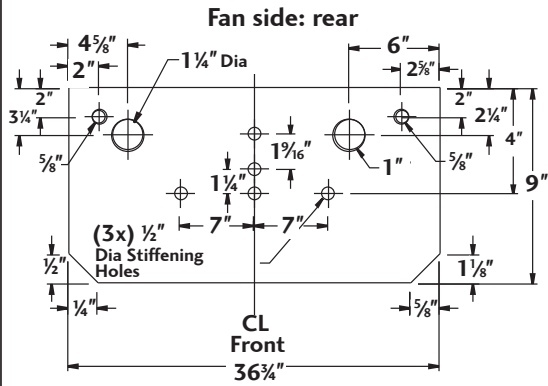

**GMC
Template No. 7**

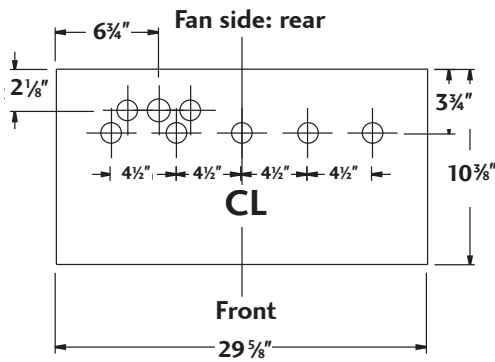

**GMC
Template No. 8**

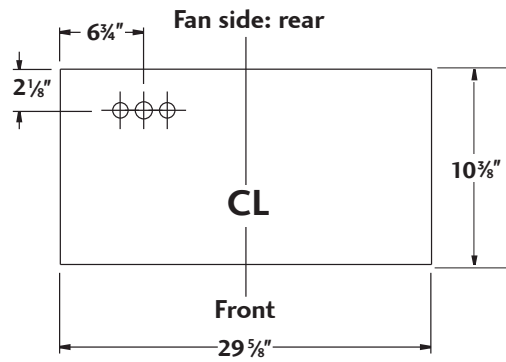

Header Templates

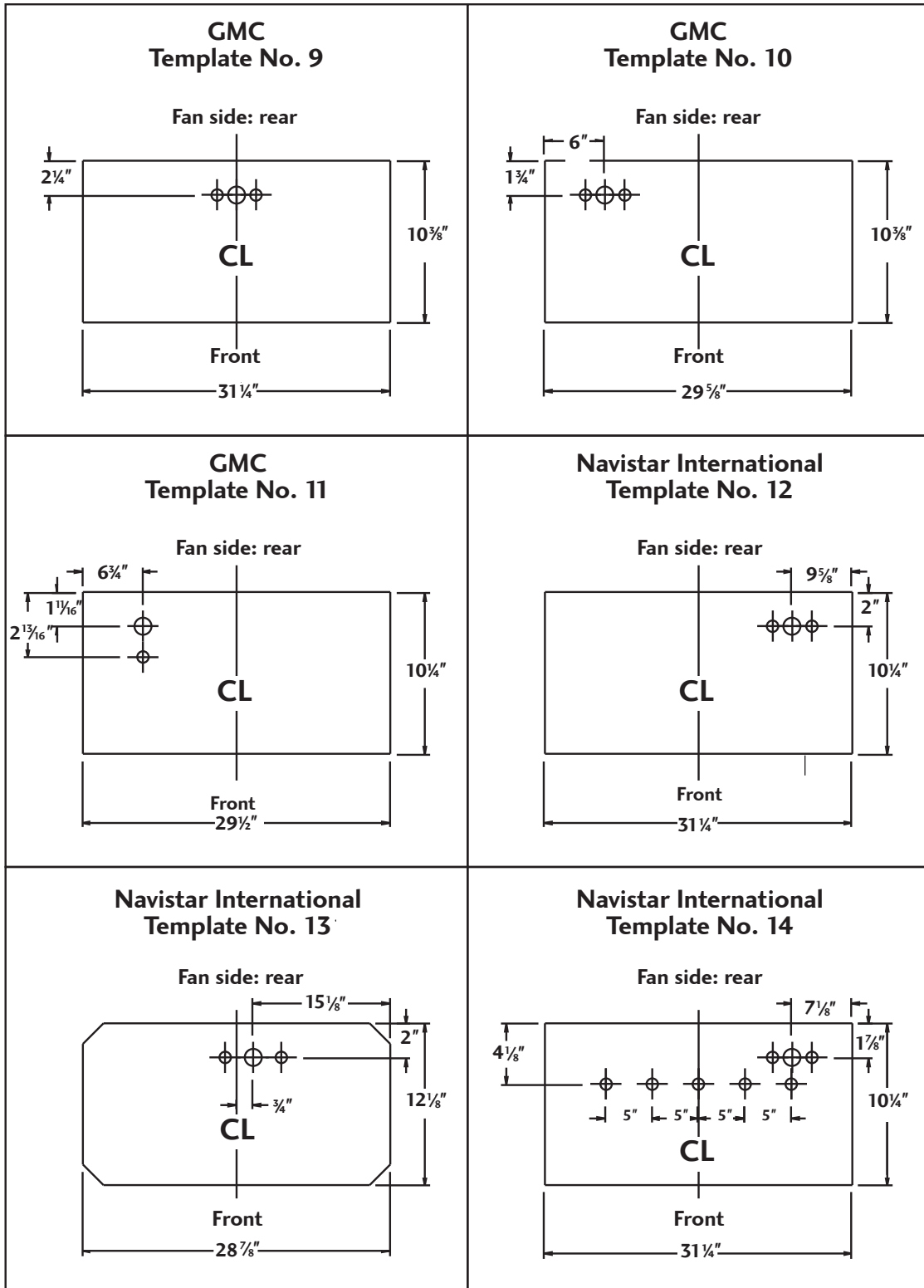

Header Templates

**Navistar International
Template No. 14A**

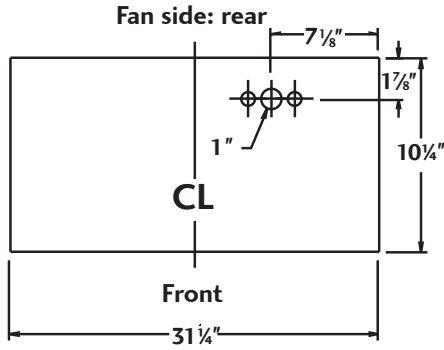

**Navistar International
Template No. 15**

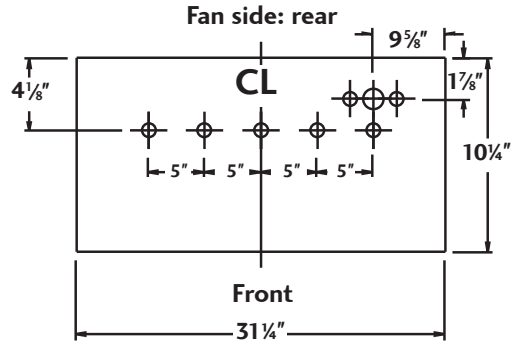

**Navistar International
Template No. 16**

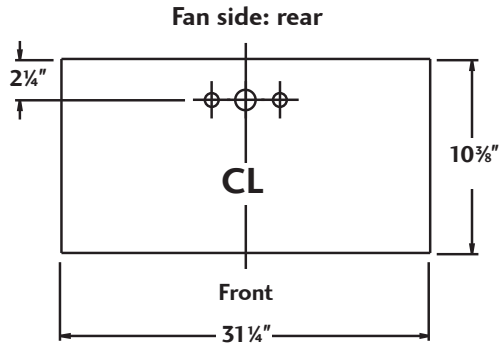

**Navistar International
Template No. 17**

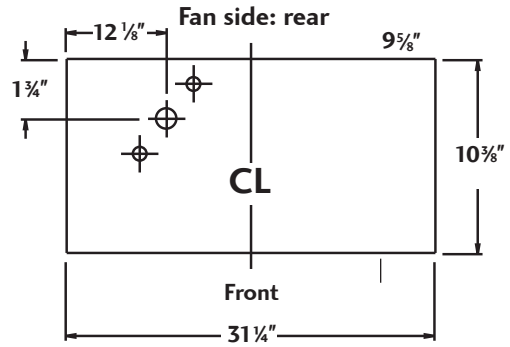

**Navistar International
Template No. 18**

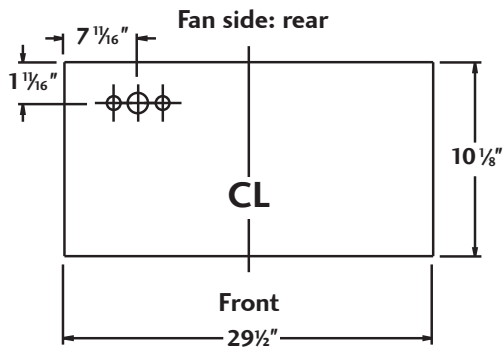

**Western Star; Volvo White GMC
Template No. 19**

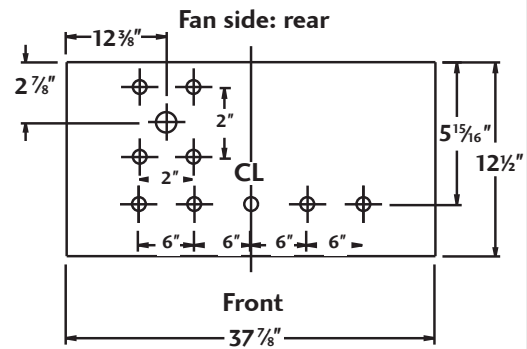

Header Templates

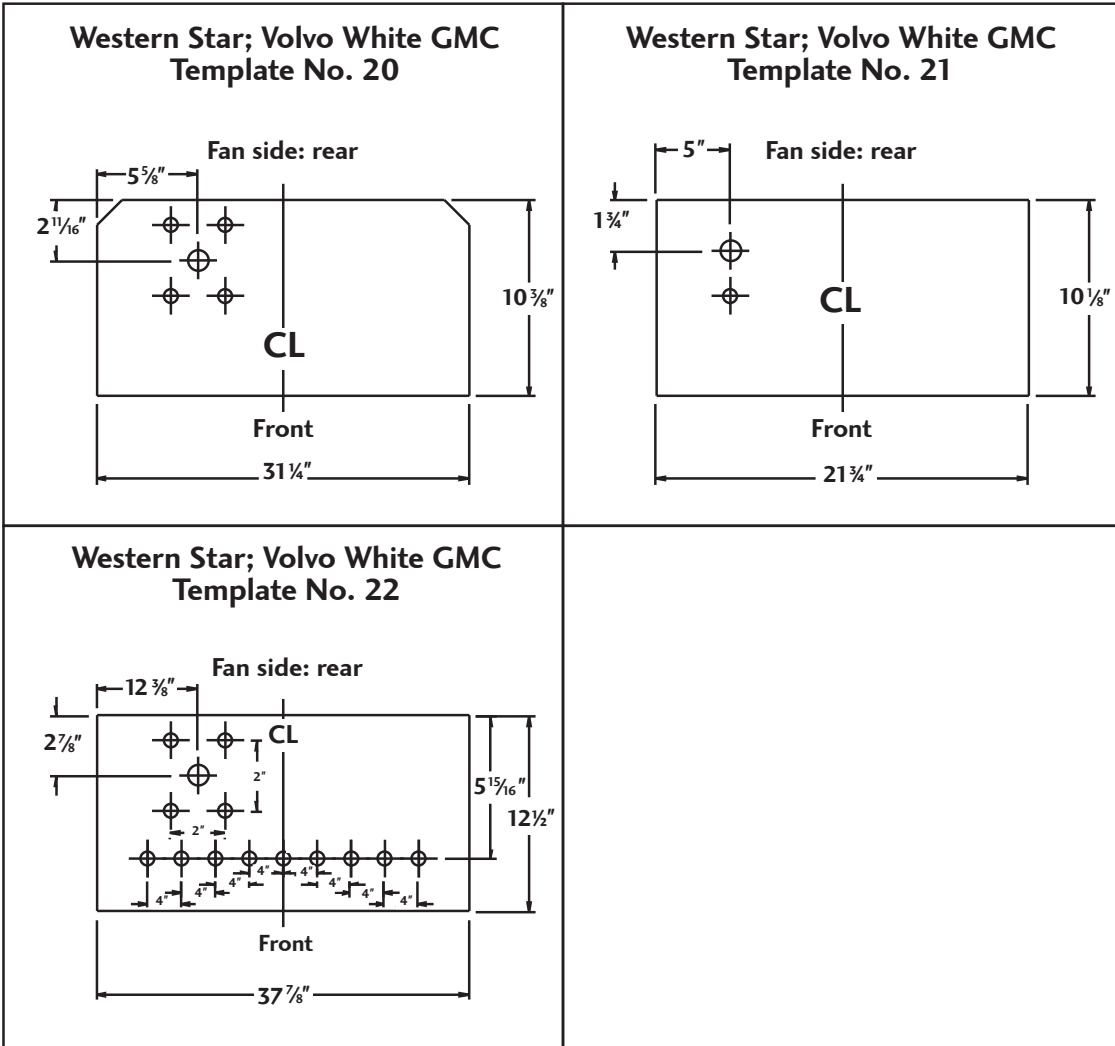

Instructions for Bolt Hole (Square Pattern)

Start here

The starting corner hole is measured from the edge of the header to the **CENTER** of the hole, this will typically be $3/8"$, $7/16"$ or $1/2"$. The following holes are measured from the center of the hole to the center of the next hole. This can be easily accomplished assuming your holes are all the same size, by measuring from the left edge of the hole to the left edge of the next hole; this eliminates trying to find the exact center of either hole.

The last measurement will be from the center of the corner hole to the edge of the header.

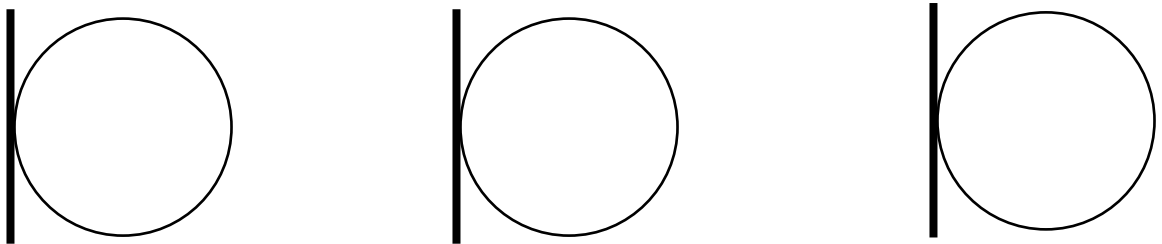

If, by chance, there aren't enough spaces for as many bolt holes as you have, you can double up some of the like holes. For example, if you have five holes at 2" apart, list them as 10 in one of the boxes. If this is done, make a note that you have done so.

In order to double check your dimensions, measure from the center of the corner hole to the center of the opposite corner hole. These measurements are actually more important than the **overall header dimensions**.

Bolt Hole (Square Pattern)

Start here	W I D T H									
	Date									
	Customer									
	Ref name									
	Core type									
	Reference No.									
	Top, bottom, both					header spec sheet				
	Header shape									
	Header gauge									
	Bolt hole size,					width				
	Bolt hole size,					length				
	Header Width									
	Center of first width corner hole to center of last width corner hole									
	Header Length									
	Center of first length corner hole to center of last length corner hole									
Total Number of Bolt Holes										

Instructions for Bolt Hole (Offset Pattern)

Start here

The first measurement should be from the edge of the header to the center of the width or length row of holes, typically $3/8"$, $7/16"$ or $1/2"$. The second will be from the edge of the header to the center of the first hole in the width or length row. The following holes are measured from the center of the hole to the center of the next hole. This can be easily accomplished assuming your holes are all the same size, by measuring from the left edge of the hole to the left edge of the next hole; this eliminates trying to find the exact center of either hole.

The last measurement will be from the center of the last hole in the row to the edge of the header.

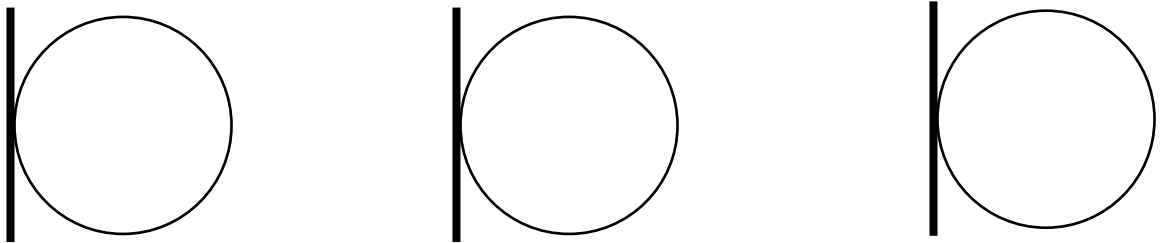

If, by chance, there aren't enough spaces for as many bolt holes as you have, you can double up some of the like holes. For example, if you have five holes at $2"$ apart, list them as 10 in one of the boxes. If this is done, make a note that you have done so.

In order to double check your dimensions, measure from the center of the width row to the center of the opposite width row. Next, measure the center of the first hole in the row to the center of the last hole in the row. These measurements are actually more important than the **overall header sizes**.

Bolt Hole (Offset Pattern)

Edge to center of rows													
	From edge to first hole			W	I	D	T	H					
			Date										
			Customer										
			Ref name										
			Core type										
			Reference no.										
			Top, bottom, both								Header spec sheet		
			Header shape								See header shapes		
			Header gauge								Light or heavy		
			Bolt hole size,								Width		
			Bolt hole size,								Length		
	H I G H	Header Width	Center of Width Row to Center of Width Row						Center of First Width Corner Hole to Center of Last Width Corner Hole				
		Header Length	Center of Length Row to Center of Length Row						Center of First Length Corner Hole to Center of Last Length Corner Hole				
		Total Number of Bolt Holes											

Crank Box Measuring Guide

Use these diagrams for measuring view from fan side of core

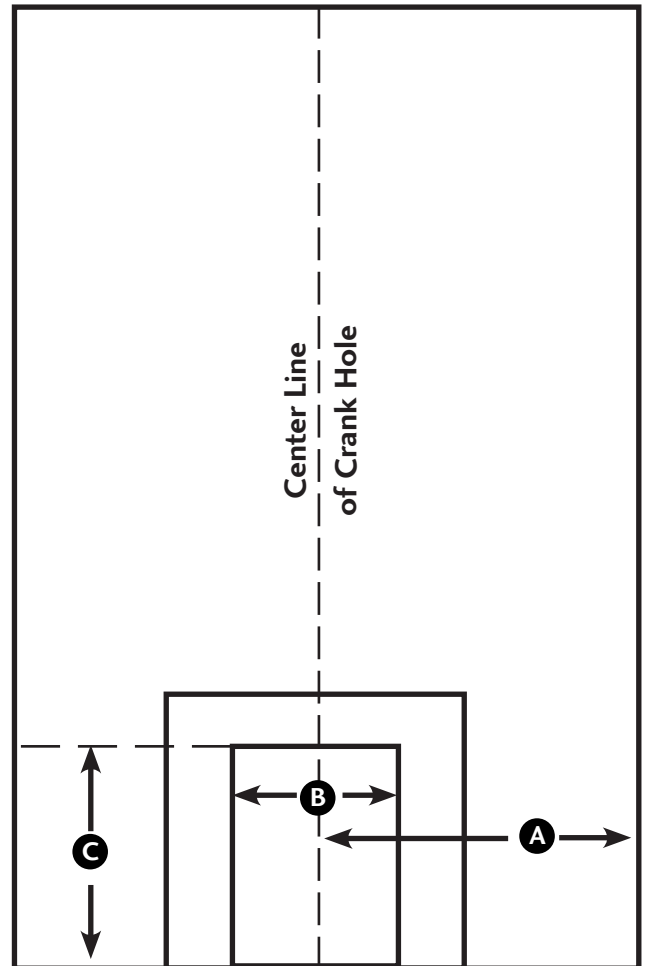
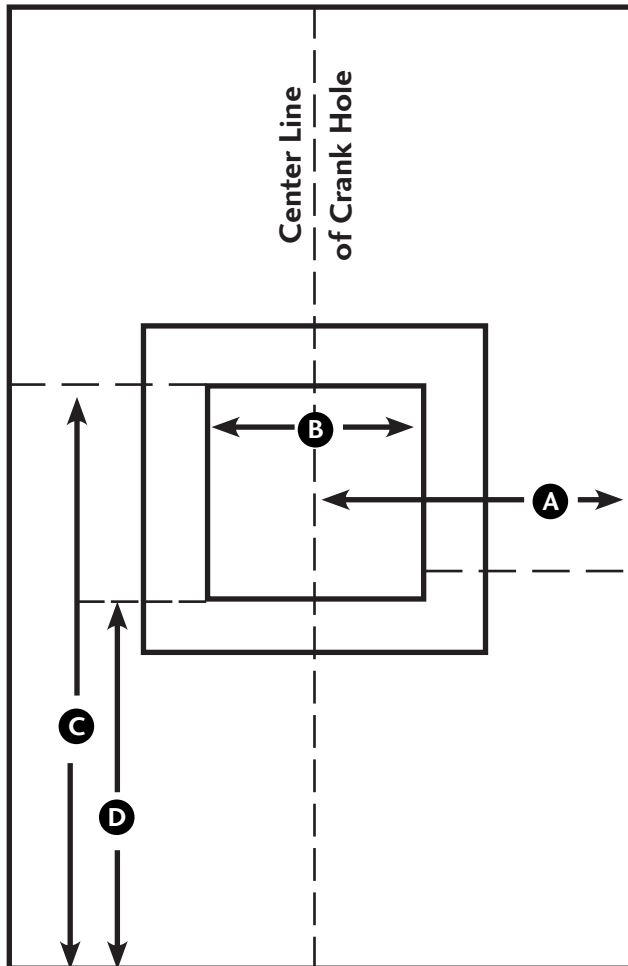

- A. Center line of crank box to side of core
- B. Width of box
- C. Top of box to bottom of header
- D. Bottom of box to bottom of header

What is FPI and How is it Measured?

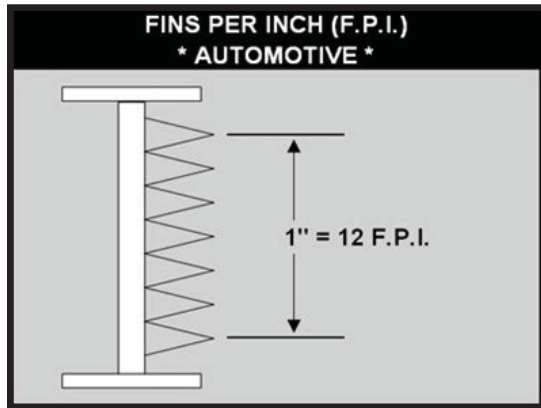

Fins Per Inch (FPI)

Automotive

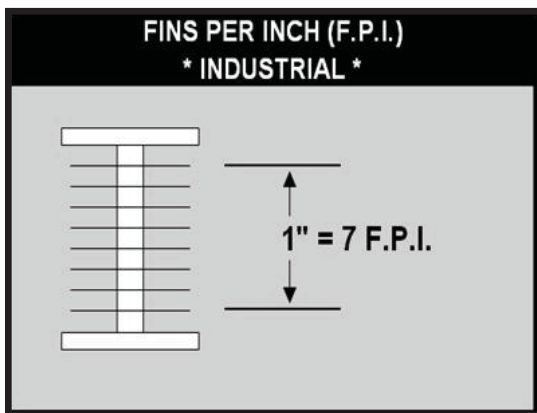
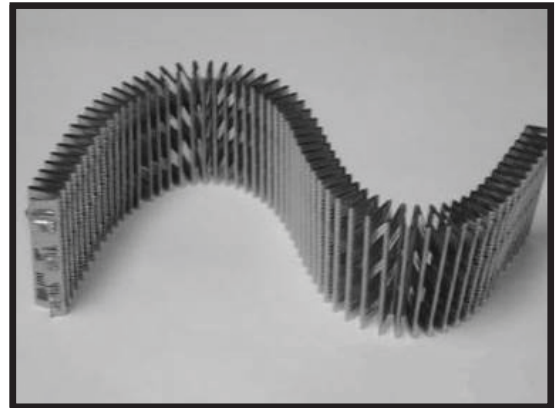

Fins Per Inch (FPI)

Industrial

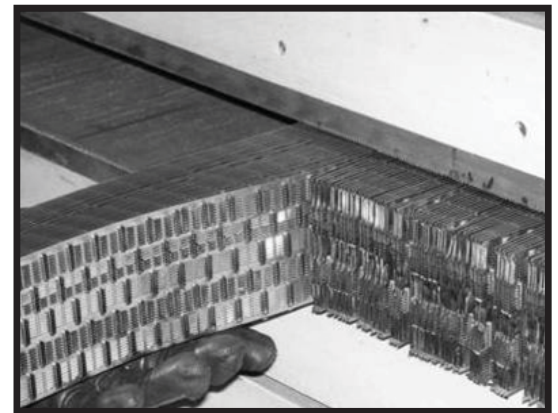

What is a tube centerline and how do I measure it?

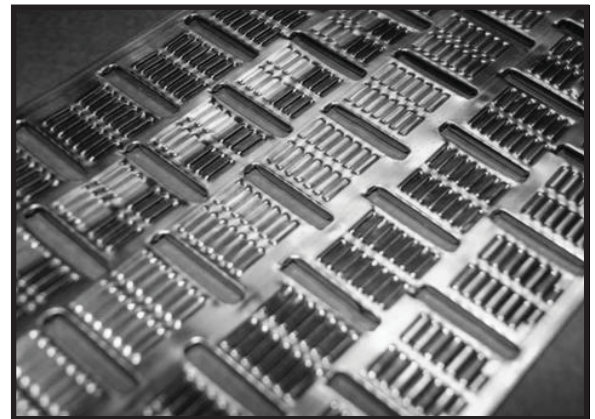
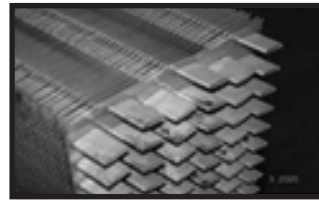
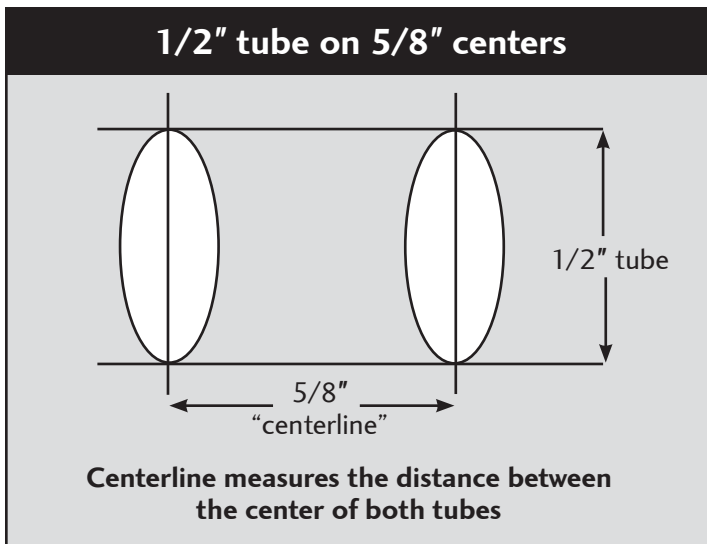

R fin (1/2" tube on 5/8" centers); staggered, louvered

Fractions-to-Decimals Conversions

Fraction	Decimal
1/64"	.0156
1/32"	.0313
3/64"	.0469
1/16"	.0625
5/64"	.0781
3/32"	.0938
7/64"	.1094
1/8"	.1250
9/64"	.1406
5/32"	.1563
11/64"	.1719
3/16"	.1875
13/64"	.2031
7/32"	.2188
15/64"	.2344
1/4"	.2500
17/64"	.2656
9/32"	.2813
19/64"	.2969
5/16"	.3125
21/64"	.3281
11/32"	.3438
23/64"	.3594
3/8"	.3750
25/64"	.3906
13/32"	.4063
27/64"	.4219
7/16"	.4375
29/64"	.4531
15/32"	.4688
31/64"	.4844
1/2"	.5000

Fraction	Decimal
33/64"	.5156
17/32"	.5313
35/64"	.5469
9/16"	.5625
37/64"	.5781
19/32"	.5938
39/64"	.6094
5/8"	.6250
41/64"	.6406
21/32"	.6563
43/64"	.6719
11/16"	.6875
45/64"	.7031
23/32"	.7188
47/64"	.7344
3/4"	.7500
49/64"	.7656
25/32"	.7813
51/64"	.7969
13/16"	.8125
53/64"	.8281
27/32"	.8438
55/64"	.8594
7/8"	.8750
57/64"	.8906
29/32"	.9063
59/64"	.9219
15/16"	.9375
61/64"	.9531
31/32"	.9688
63/64"	.9844
1"	1.0000

Special Core Order Form

For Vista-Pro Automotive Use Only

Date entered:	Time entered:	Order taken by:	Order number:
Ordering Branch (city location):		Confirmed ship date is:	
Faxed to:	Date:	Vista-Pro location:	Account number:

Customer name (business):		Address:	
City:		State:	Zip:
Person ordering special:		Date ordered:	Needed by:
Drop ship to:		Ship via:	
Drop ship city:		State:	Zip:
Special handling instructions:			
Application name (Kenworth, John Deere, model number, etc.):		Reference number:	
Number of units ordered:		Special price quoted by Vista-Pro is: \$	each

Please note that **SPECIAL CORES** may not be returned for credit!

Special Core Dimensions

Core height (between headers):		Core width (not over side pieces):		Core depth:		Tube rows:	
Core type:	Fin type:	FPI:	Fin materials (C/B/S):	Fin thickness: Standard	Special	Solder coated? <input type="checkbox"/> Yes <input type="checkbox"/> No	
Tube size:	Tube wall: <input type="checkbox"/> Standard <input type="checkbox"/> Heavy <input type="checkbox"/> Dimpled			Side piece info: <input type="checkbox"/> GM <input type="checkbox"/> Ford <input type="checkbox"/> Flat			
Top header	Width:	Length:	Thickness:	Overhang (offset):	No. bolt holes		
Headers are:	<input type="checkbox"/> Bolt-up <input type="checkbox"/> Solder-on <input type="checkbox"/> Pan		Header radius:	Reinforcements: <input type="checkbox"/> Corner <input type="checkbox"/> Center <input type="checkbox"/> Full			
Bottom header	Width:	Length:	Thickness:	Overhang (offset):	No. bolt holes		
Headers are:	<input type="checkbox"/> Bolt-up <input type="checkbox"/> Solder-on <input type="checkbox"/> Pan		Header radius:	Reinforcements: <input type="checkbox"/> Corner <input type="checkbox"/> Center <input type="checkbox"/> Full			
Center support bars; without ears? <input type="checkbox"/> Yes <input type="checkbox"/> No			Center mounting bars: <input type="checkbox"/> Yes <input type="checkbox"/> No				

Please circle the sketch of mounting brass desired:

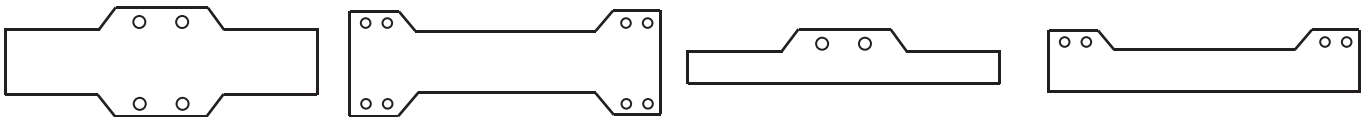

Special instructions (i.e., crank box, face coat, tube guards, etc.):



Abbreviations

(also see dropdown arrows on *Electronic Core Catalog*)

Fin material

B = brass
C = copper
S = steel
SC = solder coated

TH/BH type = top header/ bottom header type

BH = bolt-on heavy
BL = bolt-on light
BU = deep drawn bucket
BX = box
CR = crimped (not tabbed)
FR = flanged radius
GR = grooved radius
PN = pan header or recessed header
SH = special shape
SQ = square

TH Support = top header support

C = corner
CC = corner support in center
F = full reinforcement
N = none

CFMB = center fins or mounting bar (90% CAT cores)

C = center fin
R = reversible
S = single-sided
N = none

Side pieces

FD = Ford cross-flow
FL = flat side piece
GM = General Motor side piece
N = none
RC = wavy side piece (ribbed)

Tube

D = dimpled tube
S = smooth tube

TH/BH Txt = top header/bottom header text

C = centered header
FF = flush front
FR = flush rear

TPFC = tin paste face coated

2 = 2-sided paste
N = none

Miscellaneous Abbreviations

4WD = four-wheel-drive
A/C = air conditioning
A/T = automatic transmission
ALUM = aluminum
BEVLD = beveled
BH = bolt holes
BH = bottom header
BKT HDR = bucket header
BRKTS = brackets
BTM = bottom
C = centered header
C/BOX = crank box
C/FLO = cross-flow
CAC = charge air cooler
COE = cab-over engine
CONST = construction
CRNRS = corners
CRP/HDR = crimped header
CTR MTG BAR = center mounting bar

CTR = centered
CV = cellular replacement
CYL = cylinder
D = down flow
DBL = double
DIA = diameter
ENG = engine
FLNGD = flanged
FPI = fins per inch
FR = flush rear
FW = fan well
GSKTS = gaskets
HD = heavy duty
HDR = header
HDRS = headers
HVY = heavy
IMRM = individual multi-row module
INCL = including
INL = inlet
LGP = low ground pressure
LT = left
M/T = manual transmission
MAX = maximum cooling

MTG BAR = mounting bar
NTCHD = notched
O/C = oil cooler
OEM = Original Equipment Manufacturer
OH = overhang
OHF = over hang front
OVL INL = oval inlet
PTO = power take off
PTR = plastic tank radiator
RD = round
RD INL = round inlet
REG = regular
REPL = replacement
RT = right
RVS = reversible
STD = standard
T = top
TH = top header
TH or BH Shape = see header shape pictures
UF Header = Ultra-Fuse header®
W/ = with
W/O = without





Core Gaskets by Core Number

Core Gaskets

Pre-Fitted Core Gaskets

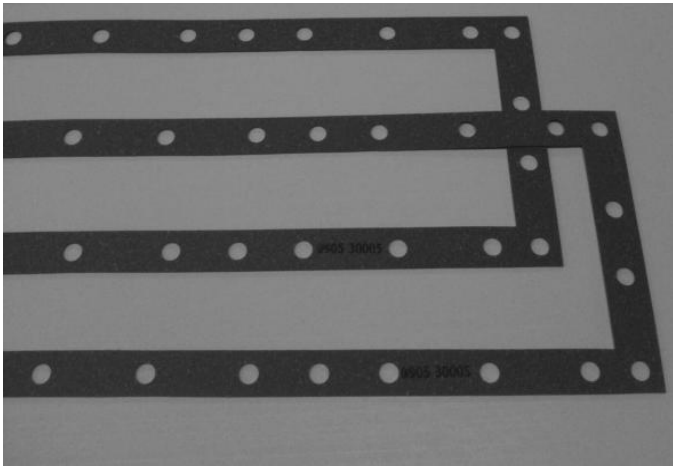

Roll of Gasket

Gasket #	Description
53000S	1/16" x 1 1/4" x 125ft Roll Standard
53000H	1/8" x 1 1/4" x 55ft Roll Heavy Duty

Gasket #	Gasket Size	Bolt Holes	Application
530001	6 3/4 x 34 1/2	40F	Freightliner
530002	7 5/16 x 32 1/8	40F	Kenworth
530003	6 1/2 x 37 1/2	42F	Peterbuilt
530004	6 x 31 1/4	42B	International
530005	6 1/4 x 36 3/8	46A	Mack
530006	6 1/4 x 42	48A	Mack
530007	7 x 43 3/8	56A	Volvo
530008	10 1/4 x 31 1/4	56XX	Ford
530009	6 x 31 1/4	52XX	Ford
530010	6 3/8 x 33	40A	Mack
530011	6 x 30 3/4	40A	International
530012	6 3/4 x 32 1/8	38A	International
530013	6 1/8 x 27 1/2	38A	International
530014	6 x 38 1/8	48A	International
530015	6 x 37 1/8	44A	Mack
530016	7 x 37 7/8	50A	Volvo
530017	6 1/4 x 25 1/4	36A	International

Pre-Fitted Core Gaskets Listed By Core Number

Core Number	Core Style	Application	Top Hdr Gasket #	Bottom Hdr Gasket #	Top Hdr Bolt Holes	Top Hdr Size	Bottom Hdr Bolt Holes	Bottom Hdr Size
223169	FF	Ford Truck	530008	530009	56XX	10 1/4 x 31 1/4	52XX	6 x 31 1/4
223304	FF	Ford Truck	530008	530009	56XX	10 1/4 x 31 1/4	52XX	6 x 31 1/4
226002	FF	Volvo Truck	530007	530007	56A	7 x 43 3/8	56A	7 x 43 3/8
226003	FF	International	530013	530013	38A	6 1/8 x 27 1/2	38A	6 1/8 x 27 1/2
226004	FF	Kenworth	530002	530002	40A	7 5/16 x 32 1/8	40A	7 5/16 x 32 1/8
226005	FF	Mack	530005	530005	46A	6 1/4 x 36 3/8	46A	6 1/4 x 36 3/8
226006	FF	Peterbuilt	530003	530003	42F	6 1/2 x 37 1/2	42F	6 1/2 x 37 1/2
226007	FF	Volvo Truck	530007	530007	56A	7 x 43 3/8	56A	7 x 43 3/8
226009	FF	Mack	530005	530005	46A	6 1/4 x 36 3/8	46A	6 1/4 x 36 3/8
226010	FF	Volvo Truck	530007	530007	56A	7 x 43 3/8	56A	7 x 43 3/8
226013	FF	International	530011	530011	40A	6 x 30 3/4	40A	6 x 30 3/4
226014	FF	Freightliner	530001	530001	40F	6 3/4 x 34 1/2	40F	6 3/4 x 34 1/2
226017	FF	International	530012	530012	38A	6 3/4 x 32 1/8	38A	6 3/4 x 32 1/8
226018	FF	Mack	530005	530005	46A	6 1/4 x 36 3/8	46A	6 1/4 x 36 3/8
226020	FF	Volvo Truck	530007	530007	56A	7 x 43 3/8	56A	7 x 43 3/8
226021	FF	Volvo Truck	530016	530016	50A	7 x 37 7/8	50A	7 x 37 7/8
226023	FF	International	530014	530014	48A	6 x 38 1/8	48A	6 x 38 1/8
226024	FF	Volvo Truck	530016	530016	50A	7 x 37 7/8	50A	7 x 37 7/8
226026	FF	International	530004	530004	42B	6 x 31 1/4	42B	6 x 31 1/4
226027	FF	Ford Truck	530008	530009	56XX	10 1/4 x 31 1/4	52XX	6 x 31 1/4
226029	FF	Volvo Truck	530016	530016	50A	7 x 37 7/8	50A	7 x 37 7/8
226030	FF	Peterbuilt	530003	530003	42F	6 1/2 x 37 1/2	42F	6 1/2 x 37 1/2

Pre-Fitted Core Gaskets Listed By Core Number

Core Number	Core Style	Application	Top Hdr Gasket #	Bottom Hdr Gasket #	Top Hdr Bolt Holes	Top Hdr Size	Bottom Hdr Bolt Holes	Bottom Hdr Size
226031	FF	Ford Truck	530008	530009	56XX	10 1/4 x 31 1/4	52XX	6 x 31 1/4
226032	FF	Kenworth	530002	530002	40A	7 5/16 x 32 1/8	40A	7 5/16 x 32 1/8
226033	FF	Freightliner	530001	530001	40F	6 3/4 x 34 1/2	40F	6 3/4 x 34 1/2
226034	FF	International	530012	530012	38A	6 3/4 x 32 1/8	38A	6 3/4 x 32 1/8
226035	FF	International	530011	530011	40A	6 x 30 3/4	40A	6 x 30 3/4
226036	FF	International	530004	530004	42B	6 x 31 1/4	42B	6 x 31 1/4
226040	FF	Kenworth	530002	530002	40A	7 5/16 x 32 1/8	40A	7 5/16 x 32 1/8
226041	FF	Peterbilt	530003	530003	42F	6 1/2 x 37 1/2	42F	6 1/2 x 37 1/2
226100	FF	Kenworth	530002	530002	40A	7 5/16 x 32 1/8	40A	7 5/16 x 32 1/8
226101	FF	Kenworth	530002	530002	40A	7 5/16 x 32 1/8	40A	7 5/16 x 32 1/8
226104	FF	Mack	530006	530006	48A	6 1/4 x 42	48A	6 1/4 x 42
226106	FF	Ford Truck	530008	530009	56XX	10 1/4 x 31 1/4	52XX	6 x 31 1/4
226107	FF	Volvo Truck	530007	530007	56A	7 x 43 3/8	56A	7 x 43 3/8
226108	FF	Ford Truck	530008	530009	56XX	10 1/4 x 31 1/4	52XX	6 x 31 1/4
226126	FF	Freightliner	530001	530001	40F	6 3/4 x 34 1/2	40F	6 3/4 x 34 1/2
226135	FF	Mack	530005	530005	46A	6 1/4 x 36 3/8	46A	6 1/4 x 36 3/8
226137	FF	Mack	530010	530010	40A	6 3/8 x 33	40A	6 3/8 x 33
226138	FF	International	530013	530013	38A	6 1/8 x 27 1/2	38A	6 1/8 x 27 1/2
226140	FF	International	530012	530012	38A	6 3/4 x 32 1/8	38A	6 3/4 x 32 1/8
226142	FF	International	530012	530012	38A	6 3/4 x 32 1/8	38A	6 3/4 x 32 1/8
226143	FF	Kenworth	530002	530002	40A	7 5/16 x 32 1/8	40A	7 5/16 x 32 1/8
226144	FF	International	530011	530011	40A	6 x 30 3/4	40A	6 x 30 3/4
226146	FF	International	530014	530014	48A	6 x 38 1/8	48A	6 x 38 1/8
226147	FF	International	530004	530004	42B	6 x 31 1/4	42B	6 x 31 1/4
226149	FF	Peterbilt	530003	530003	42F	6 1/2 x 37 1/2	42F	6 1/2 x 37 1/2
226154	FF	Mack	530005	530005	46A	6 1/4 x 36 3/8	46A	6 1/4 x 36 3/8
226156	FF	Ford Truck	530008	530009	56XX	10 1/4 x 31 1/4	52XX	6 x 31 1/4
226163	FF	Mack	530005	530005	46A	6 1/4 x 36 3/8	46A	6 1/4 x 36 3/8
226167	FF	Mack	530005	530005	46A	6 1/4 x 36 3/8	46A	6 1/4 x 36 3/8
226197	VH	International	530011	530011	40A	6 x 30 3/4	40A	6 x 30 3/4
226207	FF	Mack	530015	530015	44A	6 x 37 1/8	44A	6 x 37 1/8
226210	FF	Mack	530015	530015	44A	6 x 37 1/8	44A	6 x 37 1/8
226212	FF	Mack	530015	530015	44A	6 x 37 1/8	44A	6 x 37 1/8
226215	FF	Mack	530015	530015	44A	6 x 37 1/8	44A	6 x 37 1/8
226219	FF	Mack	530006	530006	48A	6 1/4 x 42	48A	6 1/4 x 42
226222	FF	Mack	530010	530010	40A	6 3/8 x 33	40A	6 3/8 x 33
226223	FF	Mack	530010	530010	40A	6 3/8 x 33	40A	6 3/8 x 33
226239	FF	Mack	530010	530010	40A	6 3/8 x 33	40A	6 3/8 x 33
226240	FF	Mack	530010	530010	40A	6 3/8 x 33	40A	6 3/8 x 33
226241	FF	Mack	530010	530010	40A	6 3/8 x 33	40A	6 3/8 x 33
226249	FF	Mack	530005	530005	46A	6 1/4 x 36 3/8	46A	6 1/4 x 36 3/8
226250	FF	Mack	530005	530005	46A	6 1/4 x 36 3/8	46A	6 1/4 x 36 3/8
226251	FF	Mack	530005	530005	46A	6 1/4 x 36 3/8	46A	6 1/4 x 36 3/8
226262	FF	Mack	530006	530006	48A	6 1/4 x 42	48A	6 1/4 x 42

Pre-Fitted Core Gaskets Listed By Core Number

Core Number	Core Style	Application	Top Hdr Gasket #	Bottom Hdr Gasket #	Top Hdr Bolt Holes	Top Hdr Size	Bottom Hdr Bolt Holes	Bottom Hdr Size
226269	FF	Freightliner	530001	530001	40F	6 3/4 x 34 1/2	40F	6 3/4 x 34 1/2
226286	FF	Volvo Truck	530016	530016	50A	7 x 37 7/8	50A	7 x 37 7/8
226468	FF	Freightliner	530001	530001	40F	6 3/4 x 34 1/2	40F	6 3/4 x 34 1/2
226470	FF	Freightliner	530001	530001	40F	6 3/4 x 34 1/2	40F	6 3/4 x 34 1/2
226472	FF	Freightliner	530001	530001	40F	6 3/4 x 34 1/2	40F	6 3/4 x 34 1/2
226505	FF	Freightliner	530001	530001	40F	6 3/4 x 34 1/2	40F	6 3/4 x 34 1/2
226557	FF	Kenworth	530002	530002	40A	7 5/16 x 32 1/8	40A	7 5/16 x 32 1/8
226573	FF	Volvo Truck	530016	530016	50A	7 x 37 7/8	50A	7 x 37 7/8
226584	FF	Mack	530005	530005	46A	6 1/4 x 36 3/8	46A	6 1/4 x 36 3/8
226590	FF	Mack	530015	530015	44A	6 x 37 1/8	44A	6 x 37 1/8
226596	FF	Mack	530010	530010	40A	6 3/8 x 33	40A	6 3/8 x 33
226610	FF	Mack	530010	530010	40A	6 3/8 x 33	40A	6 3/8 x 33
226611	FF	Mack	530005	530005	46A	6 1/4 x 36 3/8	46A	6 1/4 x 36 3/8
226612	FF	Mack	530005	530005	46A	6 1/4 x 36 3/8	46A	6 1/4 x 36 3/8
226613	FF	Mack	530005	530005	46A	6 1/4 x 36 3/8	46A	6 1/4 x 36 3/8
226614	FF	Mack	530010	530010	40A	6 3/8 x 33	40A	6 3/8 x 33
226615	FF	Mack	530010	530010	40A	6 3/8 x 33	40A	6 3/8 x 33
226645	FF	International	530017	530017	36A	6 1/4 x 25 1/4	36A	6 1/4 x 25 1/4
226657	FF	International	530013	530013	38A	6 1/8 x 27 1/2	38A	6 1/8 x 27 1/2
226683	FF	International	530011	530011	40A	6 x 30 3/4	40A	6 x 30 3/4
226684	FF	International	530011	530011	40A	6 x 30 3/4	40A	6 x 30 3/4
226685	FF	International	530014	530014	48A	6 x 38 1/8	48A	6 x 38 1/8
226736	FF	Volvo Truck	530007	530007	56A	7 x 43 3/8	56A	7 x 43 3/8
226744	FF	Volvo Truck	530016	530016	50A	7 x 37 7/8	50A	7 x 37 7/8
226745	FF	Volvo Truck	530016	530016	50A	7 x 37 7/8	50A	7 x 37 7/8
226746	FF	Volvo Truck	530016	530016	50A	7 x 37 7/8	50A	7 x 37 7/8
226747	FF	Volvo Truck	530016	530016	50A	7 x 37 7/8	50A	7 x 37 7/8
226748	FF	Volvo Truck	530016	530016	50A	7 x 37 7/8	50A	7 x 37 7/8
226749	FF	Volvo Truck	530016	530016	50A	7 x 37 7/8	50A	7 x 37 7/8
226750	FF	Volvo Truck	530007	530007	56A	7 x 43 3/8	56A	7 x 43 3/8
226760	FF	Volvo Truck	530016	530016	50A	7 x 37 7/8	50A	7 x 37 7/8
226761	FF	Volvo Truck	530016	530016	50A	7 x 37 7/8	50A	7 x 37 7/8
226762	FF	Volvo Truck	530016	530016	50A	7 x 37 7/8	50A	7 x 37 7/8
226763	FF	Volvo Truck	530016	530016	50A	7 x 37 7/8	50A	7 x 37 7/8
226764	FF	Volvo Truck	530016	530016	50A	7 x 37 7/8	50A	7 x 37 7/8
226765	FF	Volvo Truck	530016	530016	50A	7 x 37 7/8	50A	7 x 37 7/8
226766	FF	Volvo Truck	530016	530016	50A	7 x 37 7/8	50A	7 x 37 7/8
226767	FF	Volvo Truck	530016	530016	50A	7 x 37 7/8	50A	7 x 37 7/8
226768	FF	Volvo Truck	530016	530016	50A	7 x 37 7/8	50A	7 x 37 7/8
226769	FF	Volvo Truck	530016	530016	50A	7 x 37 7/8	50A	7 x 37 7/8
226772	FF	Volvo Truck	530016	530016	50A	7 x 37 7/8	50A	7 x 37 7/8
226773	FF	Volvo Truck	530016	530016	50A	7 x 37 7/8	50A	7 x 37 7/8
226774	FF	Volvo Truck	530016	530016	50A	7 x 37 7/8	50A	7 x 37 7/8
226775	FF	Volvo Truck	530016	530016	50A	7 x 37 7/8	50A	7 x 37 7/8

Pre-Fitted Core Gaskets Listed By Core Number

Core Number	Core Style	Application	Top Hdr Gasket #	Bottom Hdr Gasket #	Top Hdr Bolt Holes	Top Hdr Size	Bottom Hdr Bolt Holes	Bottom Hdr Size
226776	FF	Volvo Truck	530016	530016	50A	7 x 37 7/8	50A	7 x 37 7/8
226777	FF	Volvo Truck	530016	530016	50A	7 x 37 7/8	50A	7 x 37 7/8
226814	FF	Kenworth	530002	530002	40A	7 5/16 x 32 1/8	40A	7 5/16 x 32 1/8
226844	FF	International	530004	530004	42B	6 x 31 1/4	42B	6 x 31 1/4
226846	FF	Peterbuilt	530003	530003	42F	6 1/2 x 37 1/2	42F	6 1/2 x 37 1/2
226890	FF	International	530013	530013	38A	6 1/8 x 27 1/2	38A	6 1/8 x 27 1/2
226893	FF	International	530011	530011	40A	6 x 30 3/4	40A	6 x 30 3/4
251002	VH	Kenworth	530002	530002	40A	7 5/16 x 32 1/8	40A	7 5/16 x 32 1/8
251003	VH	Mack	530005	530005	46A	6 1/4 x 36 3/8	46A	6 1/4 x 36 3/8
251006	VH	Freightliner	530001	530001	40F	6 3/4 x 34 1/2	40F	6 3/4 x 34 1/2
251007	VH	International	530004	530004	42B	6 x 31 1/4	42B	6 x 31 1/4
251008	VH	Volvo Truck	530007	530007	56A	7 x 43 3/8	56A	7 x 43 3/8
251009	VH	Freightliner	530001	530001	40F	6 3/4 x 34 1/2	40F	6 3/4 x 34 1/2
251010	VH	Kenworth	530002	530002	40A	7 5/16 x 32 1/8	40A	7 5/16 x 32 1/8
251014	VH	International	530013	530013	38A	6 1/8 x 27 1/2	38A	6 1/8 x 27 1/2
251015	VH	Kenworth	530002	530002	40A	7 5/16 x 32 1/8	40A	7 5/16 x 32 1/8
251016	VH	Peterbuilt	530003	530003	42F	6 1/2 x 37 1/2	42F	6 1/2 x 37 1/2
251017	VH	Volvo Truck	530007	530007	56A	7 x 43 3/8	56A	7 x 43 3/8
251019	VH	Mack	530005	530005	46A	6 1/4 x 36 3/8	46A	6 1/4 x 36 3/8
251021	VH	International	530011	530011	40A	6 x 30 3/4	40A	6 x 30 3/4
251024	VH	International	530012	530012	38A	6 3/4 x 32 1/8	38A	6 3/4 x 32 1/8
251025	VH	Mack	530005	530005	46A	6 1/4 x 36 3/8	46A	6 1/4 x 36 3/8
251026	VH	Volvo Truck	530007	530007	56A	7 x 43 3/8	56A	7 x 43 3/8
251027	VH	Volvo Truck	530016	530016	50A	7 x 37 7/8	50A	7 x 37 7/8
251028	VH	International	530014	530014	48A	6 x 38 1/8	48A	6 x 38 1/8
251029	VH	Volvo Truck	530016	530016	50A	7 x 37 7/8	50A	7 x 37 7/8
251031	VH	Ford Truck	530008	530009	56XX	10 1/4 x 31 1/4	52XX	6 x 31 1/4
251032	VH	Volvo Truck	530016	530016	50A	7 x 37 7/8	50A	7 x 37 7/8
251033	VH	Peterbuilt	530003	530003	42F	6 1/2 x 37 1/2	42F	6 1/2 x 37 1/2
251034	VH	Ford Truck	530008	530009	56XX	10 1/4 x 31 1/4	52XX	6 x 31 1/4
251035	VH	International	530012	530012	38A	6 3/4 x 32 1/8	38A	6 3/4 x 32 1/8
251036	VH	International	530011	530011	40A	6 x 30 3/4	40A	6 x 30 3/4
251037	VH	International	530004	530004	42B	6 x 31 1/4	42B	6 x 31 1/4
251040	VH	Kenworth	530002	530002	40A	7 5/16 x 32 1/8	40A	7 5/16 x 32 1/8
251041	VH	Peterbuilt	530003	530003	42F	6 1/2 x 37 1/2	42F	6 1/2 x 37 1/2
251101	VH	Ford Truck	530008	530009	56XX	10 1/4 x 31 1/4	52XX	6 x 31 1/4
251102	VH	Freightliner	530001	530001	40F	6 3/4 x 34 1/2	40F	6 3/4 x 34 1/2
251103	VH	Kenworth	530002	530002	40A	7 5/16 x 32 1/8	40A	7 5/16 x 32 1/8
251104	VH	Freightliner	530001	530001	40F	6 3/4 x 34 1/2	40F	6 3/4 x 34 1/2
251105	VH	Ford Truck	530008	530009	56XX	10 1/4 x 31 1/4	52XX	6 x 31 1/4
251106	VH	Mack	530006	530006	48A	6 1/4 x 42	48A	6 1/4 x 42
251107	VH	Ford Truck	530008	530009	56XX	10 1/4 x 31 1/4	52XX	6 x 31 1/4
251108	VH	Mack	530010	530010	40A	6 3/8 x 33	40A	6 3/8 x 33
251110	VH	Mack	530015	530015	44A	6 x 37 1/8	44A	6 x 37 1/8

Pre-Fitted Core Gaskets Listed By Core Number

Core Number	Core Style	Application	Top Hdr Gasket #	Bottom Hdr Gasket #	Top Hdr Bolt Holes	Top Hdr Size	Bottom Hdr Bolt Holes	Bottom Hdr Size
251112	VH	International	530012	530012	38A	6 3/4 x 32 1/8	38A	6 3/4 x 32 1/8
251113	VH	International	530011	530011	40A	6 x 30 3/4	40A	6 x 30 3/4
251114	VH	International	530012	530012	38A	6 3/4 x 32 1/8	38A	6 3/4 x 32 1/8
251115	VH	Mack	530005	530005	46A	6 1/4 x 36 3/8	46A	6 1/4 x 36 3/8
251116	VH	International	530012	530012	38A	6 3/4 x 32 1/8	38A	6 3/4 x 32 1/8
251118	VH	Peterbuilt	530003	530003	42F	6 1/2 x 37 1/2	42F	6 1/2 x 37 1/2
251120	VH	International	530011	530011	40A	6 x 30 3/4	40A	6 x 30 3/4
251121	VH	International	530004	530004	42B	6 x 31 1/4	42B	6 x 31 1/4
251122	VH	Volvo Truck	530007	530007	56A	7 x 43 3/8	56A	7 x 43 3/8
251123	VH	Peterbuilt	530003	530003	42F	6 1/2 x 37 1/2	42F	6 1/2 x 37 1/2
251124	VH	International	530004	530004	42B	6 x 31 1/4	42B	6 x 31 1/4
251126	VH	Mack	530006	530006	48A	6 1/4 x 42	48A	6 1/4 x 42
251128	VH	Mack	530005	530005	46A	6 1/4 x 36 3/8	46A	6 1/4 x 36 3/8
251130	VH	Mack	530006	530006	48A	6 1/4 x 42	48A	6 1/4 x 42
251132	VH	International	530017	530017	36A	6 1/4 x 25 1/4	36A	6 1/4 x 25 1/4
251133	VH	International	530013	530013	38A	6 1/8 x 27 1/2	38A	6 1/8 x 27 1/2
251136	VH	Mack	530005	530005	46A	6 1/4 x 36 3/8	46A	6 1/4 x 36 3/8
251141	VH	Mack	530005	530005	46A	6 1/4 x 36 3/8	46A	6 1/4 x 36 3/8
252002	VTH	Kenworth	530002	530002	40A	7 5/16 x 32 1/8	40A	7 5/16 x 32 1/8
252003	VTH	Mack	530005	530005	46A	6 1/4 x 36 3/8	46A	6 1/4 x 36 3/8
252006	VTH	Freightliner	530001	530001	40F	6 3/4 x 34 1/2	40F	6 3/4 x 34 1/2
252007	VTH	International	530004	530004	42B	6 x 31 1/4	42B	6 x 31 1/4
252008	VTH	Volvo Truck	530007	530007	56A	7 x 43 3/8	56A	7 x 43 3/8
252009	VTH	Freightliner	530001	530001	40F	6 3/4 x 34 1/2	40F	6 3/4 x 34 1/2
252010	VTH	Kenworth	530002	530002	40A	7 5/16 x 32 1/8	40A	7 5/16 x 32 1/8
252015	VTH	Kenworth	530002	530002	40A	7 5/16 x 32 1/8	40A	7 5/16 x 32 1/8
252021	VTH	International	530011	530011	40A	6 x 30 3/4	40A	6 x 30 3/4
252024	VTH	International	530012	530012	38A	6 3/4 x 32 1/8	38A	6 3/4 x 32 1/8
252028	VTH	International	530014	530014	48A	6 x 38 1/8	48A	6 x 38 1/8
252029	VTH	Volvo Truck	530016	530016	50A	7 x 37 7/8	50A	7 x 37 7/8
252033	VTH	Peterbuilt	530003	530003	42F	6 1/2 x 37 1/2	42F	6 1/2 x 37 1/2
252034	VTH	Ford Truck	530008	530009	56XX	10 1/4 x 31 1/4	52XX	6 x 31 1/4
252035	VTH	International	530012	530012	38A	6 3/4 x 32 1/8	38A	6 3/4 x 32 1/8
252040	VTH	Kenworth	530002	530002	40A	7 5/16 x 32 1/8	40A	7 5/16 x 32 1/8
252041	VTH	Peterbuilt	530003	530003	42F	6 1/2 x 37 1/2	42F	6 1/2 x 37 1/2
252102	VTH	Freightliner	530001	530001	40F	6 3/4 x 34 1/2	40F	6 3/4 x 34 1/2
252103	VTH	Kenworth	530002	530002	40A	7 5/16 x 32 1/8	40A	7 5/16 x 32 1/8
252104	VTH	Freightliner	530001	530001	40F	6 3/4 x 34 1/2	40F	6 3/4 x 34 1/2
252107	VTH	Ford Truck	530008	530009	56XX	10 1/4 x 31 1/4	52XX	6 x 31 1/4
252108	VTH	Mack	530010	530010	40A	6 3/8 x 33	40A	6 3/8 x 33
252110	VTH	Mack	530015	530015	44A	6 x 37 1/8	44A	6 x 37 1/8
252112	VTH	International	530012	530012	38A	6 3/4 x 32 1/8	38A	6 3/4 x 32 1/8
252116	VTH	International	530012	530012	38A	6 3/4 x 32 1/8	38A	6 3/4 x 32 1/8
252118	VTH	Peterbuilt	530003	530003	42F	6 1/2 x 37 1/2	42F	6 1/2 x 37 1/2

Pre-Fitted Core Gaskets Listed By Core Number

Core Number	Core Style	Application	Top Hdr Gasket #	Bottom Hdr Gasket #	Top Hdr Bolt Holes	Top Hdr Size	Bottom Hdr Bolt Holes	Bottom Hdr Size
252120	VTH	International	530011	530011	40A	6 x 30 3/4	40A	6 x 30 3/4
252121	VTH	International	530004	530004	42B	6 x 31 1/4	42B	6 x 31 1/4
252122	VTH	Volvo Truck	530007	530007	56A	7 x 43 3/8	56A	7 x 43 3/8
252123	VTH	Peterbuilt	530003	530003	42F	6 1/2 x 37 1/2	42F	6 1/2 x 37 1/2
252126	VTH	Mack	530006	530006	48A	6 1/4 x 42	48A	6 1/4 x 42
252128	VTH	Mack	530005	530005	46A	6 1/4 x 36 3/8	46A	6 1/4 x 36 3/8
252132	VTH	International	530017	530017	36A	6 1/4 x 25 1/4	36A	6 1/4 x 25 1/4
252136	VTH	Mack	530005	530005	46A	6 1/4 x 36 3/8	46A	6 1/4 x 36 3/8
252141	VTH	Mack	530005	530005	46A	6 1/4 x 36 3/8	46A	6 1/4 x 36 3/8
253002	VTH	Kenworth	530002	530002	40A	7 5/16 x 32 1/8	40A	7 5/16 x 32 1/8
253003	VTH	Mack	530005	530005	46A	6 1/4 x 36 3/8	46A	6 1/4 x 36 3/8
253006	VTH	Freightliner	530001	530001	40F	6 3/4 x 34 1/2	40F	6 3/4 x 34 1/2
253007	VTH	International	530004	530004	42B	6 x 31 1/4	42B	6 x 31 1/4
253008	VTH	Volvo Truck	530007	530007	56A	7 x 43 3/8	56A	7 x 43 3/8
253009	VTH	Freightliner	530001	530001	40F	6 3/4 x 34 1/2	40F	6 3/4 x 34 1/2
253010	VTH	Kenworth	530002	530002	40A	7 5/16 x 32 1/8	40A	7 5/16 x 32 1/8
253015	VTH	Kenworth	530002	530002	40A	7 5/16 x 32 1/8	40A	7 5/16 x 32 1/8
253021	VTH	International	530011	530011	40A	6 x 30 3/4	40A	6 x 30 3/4
253024	VTH	International	530012	530012	38A	6 3/4 x 32 1/8	38A	6 3/4 x 32 1/8
253028	VTH	International	530014	530014	48A	6 x 38 1/8	48A	6 x 38 1/8
253029	VTH	Volvo Truck	530016	530016	50A	7 x 37 7/8	50A	7 x 37 7/8
253033	VTH	Peterbuilt	530003	530003	42F	6 1/2 x 37 1/2	42F	6 1/2 x 37 1/2
253034	VTH	Ford Truck	530008	530009	56XX	10 1/4 x 31 1/4	52XX	6 x 31 1/4
253035	VTH	International	530012	530012	38A	6 3/4 x 32 1/8	38A	6 3/4 x 32 1/8
253040	VTH	Kenworth	530002	530002	40A	7 5/16 x 32 1/8	40A	7 5/16 x 32 1/8
253041	VTH	Peterbuilt	530003	530003	42F	6 1/2 x 37 1/2	42F	6 1/2 x 37 1/2
253102	VTH	Freightliner	530001	530001	40F	6 3/4 x 34 1/2	40F	6 3/4 x 34 1/2
253103	VTH	Kenworth	530002	530002	40A	7 5/16 x 32 1/8	40A	7 5/16 x 32 1/8
253104	VTH	Freightliner	530001	530001	40F	6 3/4 x 34 1/2	40F	6 3/4 x 34 1/2
253107	VTH	Ford Truck	530008	530009	56XX	10 1/4 x 31 1/4	52XX	6 x 31 1/4
253108	VTH	Mack	530010	530010	40A	6 3/8 x 33	40A	6 3/8 x 33
253110	VTH	Mack	530015	530015	44A	6 x 37 1/8	44A	6 x 37 1/8
253112	VTH	International	530012	530012	38A	6 3/4 x 32 1/8	38A	6 3/4 x 32 1/8
253116	VTH	International	530012	530012	38A	6 3/4 x 32 1/8	38A	6 3/4 x 32 1/8
253118	VTH	Peterbuilt	530003	530003	42F	6 1/2 x 37 1/2	42F	6 1/2 x 37 1/2
253120	VTH	International	530011	530011	40A	6 x 30 3/4	40A	6 x 30 3/4
253121	VTH	International	530004	530004	42B	6 x 31 1/4	42B	6 x 31 1/4
253122	VTH	Volvo Truck	530007	530007	56A	7 x 43 3/8	56A	7 x 43 3/8
253123	VTH	Peterbuilt	530003	530003	42F	6 1/2 x 37 1/2	42F	6 1/2 x 37 1/2
253126	VTH	Mack	530006	530006	48A	6 1/4 x 42	48A	6 1/4 x 42
253128	VTH	Mack	530005	530005	46A	6 1/4 x 36 3/8	46A	6 1/4 x 36 3/8
253132	VTH	International	530017	530017	36A	6 1/4 x 25 1/4	36A	6 1/4 x 25 1/4
253136	VTH	Mack	530005	530005	46A	6 1/4 x 36 3/8	46A	6 1/4 x 36 3/8
253141	VTH	Mack	530005	530005	46A	6 1/4 x 36 3/8	46A	6 1/4 x 36 3/8

Pre-Fitted Core Gaskets Listed By Core Number

Core Number	Core Style	Application	Top Hdr Gasket #	Bottom Hdr Gasket #	Top Hdr Bolt Holes	Top Hdr Size	Bottom Hdr Bolt Holes	Bottom Hdr Size
265541	FF	Volvo Truck	530016	530016	50A	7 x 37 7/8	50A	7 x 37 7/8
265588	FF	International	530012	530012	38A	6 3/4 x 32 1/8	38A	6 3/4 x 32 1/8
265601	FF	Volvo Truck	530016	530016	50A	7 x 37 7/8	50A	7 x 37 7/8
265657	FF	Mack	530015	530015	44A	6 x 37 1/8	44A	6 x 37 1/8
265680	FF	Volvo Truck	530016	530016	50A	7 x 37 7/8	50A	7 x 37 7/8
266232	FF	Volvo Truck	530016	530016	50A	7 x 37 7/8	50A	7 x 37 7/8
281933	U-Fuse	Mack	530015	530015	44A	6 x 37 1/8	44A	6 x 37 1/8
282123	U-Fuse	Mack	530010	530010	40A	6 3/8 x 33	40A	6 3/8 x 33
282125	FF	Mack	530005	530005	46A	6 1/4 x 36 3/8	46A	6 1/4 x 36 3/8
282126	U-Fuse	Mack	530005	530005	46A	6 1/4 x 36 3/8	46A	6 1/4 x 36 3/8
282127	FF	Mack	530005	530005	46A	6 1/4 x 36 3/8	46A	6 1/4 x 36 3/8
284010	U-Fuse	International	530004	530004	42B	6 x 31 1/4	42B	6 x 31 1/4
284015	U-Fuse	International	530012	530012	38A	6 3/4 x 32 1/8	38A	6 3/4 x 32 1/8
284020	U-Fuse	Mack	530005	530005	46A	6 1/4 x 36 3/8	46A	6 1/4 x 36 3/8
284030	U-Fuse	Peterbuilt	530003	530003	42F	6 1/2 x 37 1/2	42F	6 1/2 x 37 1/2
284045	U-Fuse	Mack	530006	530006	48A	6 1/4 x 42	48A	6 1/4 x 42
284050	U-Fuse	Mack	530006	530006	48A	6 1/4 x 42	48A	6 1/4 x 42
284055	U-Fuse	Kenworth	530002	530002	40A	7 5/16 x 32 1/8	40A	7 5/16 x 32 1/8
284065	U-Fuse	Peterbuilt	530003	530003	42F	6 1/2 x 37 1/2	42F	6 1/2 x 37 1/2
284070	U-Fuse	Ford Truck	530008	530009	56XX	10 1/4 x 31 1/4	52XX	6 x 31 1/4
284075	U-Fuse	Mack	530005	530005	46A	6 1/4 x 36 3/8	46A	6 1/4 x 36 3/8
284078	U-Fuse	International	530012	530012	38A	6 3/4 x 32 1/8	38A	6 3/4 x 32 1/8
284080	U-Fuse	Kenworth	530002	530002	40A	7 5/16 x 32 1/8	40A	7 5/16 x 32 1/8
284315	U-Fuse	International	530014	530014	48A	6 x 38 1/8	48A	6 x 38 1/8
284395	U-Fuse	Volvo Truck	530007	530007	56A	7 x 43 3/8	56A	7 x 43 3/8
284511	U-Fuse	Volvo Truck	530016	530016	50A	7 x 37 7/8	50A	7 x 37 7/8
284519	U-Fuse	Kenworth	530002	530002	40A	7 5/16 x 32 1/8	40A	7 5/16 x 32 1/8
284626	U-Fuse	Kenworth	530002	530002	40A	7 5/16 x 32 1/8	40A	7 5/16 x 32 1/8
284628	U-Fuse	Mack	530005	530005	46A	6 1/4 x 36 3/8	46A	6 1/4 x 36 3/8
284628	U-Fuse	Mack	530005	530005	46A	6 1/4 x 36 3/8	46A	6 1/4 x 36 3/8
284629	U-Fuse	Mack	530005	530005	46A	6 1/4 x 36 3/8	46A	6 1/4 x 36 3/8
284631	U-Fuse	Freightliner	530001	530001	40F	6 3/4 x 34 1/2	40F	6 3/4 x 34 1/2
284632	U-Fuse	Freightliner	530001	530001	40F	6 3/4 x 34 1/2	40F	6 3/4 x 34 1/2
284646	U-Fuse	Peterbuilt	530003	530003	42F	6 1/2 x 37 1/2	42F	6 1/2 x 37 1/2
284647	U-Fuse	Freightliner	530001	530001	40F	6 3/4 x 34 1/2	40F	6 3/4 x 34 1/2
284648	U-Fuse	Freightliner	530001	530001	40F	6 3/4 x 34 1/2	40F	6 3/4 x 34 1/2
284653	U-Fuse	Kenworth	530002	530002	40A	7 5/16 x 32 1/8	40A	7 5/16 x 32 1/8
284688	U-Fuse	Ford Truck	530008	530009	56XX	10 1/4 x 31 1/4	52XX	6 x 31 1/4
284690	U-Fuse	Volvo Truck	530016	530016	50A	7 x 37 7/8	50A	7 x 37 7/8
284691	U-Fuse	Volvo Truck	530016	530016	50A	7 x 37 7/8	50A	7 x 37 7/8
284692	U-Fuse	International	530014	530014	48A	6 x 38 1/8	48A	6 x 38 1/8
284693	U-Fuse	International	530011	530011	40A	6 x 30 3/4	40A	6 x 30 3/4
284694	U-Fuse	International	530013	530013	38A	6 1/8 x 27 1/2	38A	6 1/8 x 27 1/2
284695	U-Fuse	Mack	530005	530005	46A	6 1/4 x 36 3/8	46A	6 1/4 x 36 3/8

Pre-Fitted Core Gaskets Listed By Core Number

Core Number	Core Style	Application	Top Hdr Gasket #	Bottom Hdr Gasket #	Top Hdr Bolt Holes	Top Hdr Size	Bottom Hdr Bolt Holes	Bottom Hdr Size
284697	U-Fuse	Mack	530010	530010	40A	6 3/8 x 33	40A	6 3/8 x 33
284708	U-Fuse	Peterbuilt	530003	530003	42F	6 1/2 x 37 1/2	42F	6 1/2 x 37 1/2
284715	U-Fuse	International	530004	530004	42B	6 x 31 1/4	42B	6 x 31 1/4
284718	U-Fuse	Mack	530005	530005	46A	6 1/4 x 36 3/8	46A	6 1/4 x 36 3/8
284719	U-Fuse	Ford Truck	530008	530009	56XX	10 1/4 x 31 1/4	52XX	6 x 31 1/4
284722	U-Fuse	Ford Truck	530008	530009	56XX	10 1/4 x 31 1/4	52XX	6 x 31 1/4
284724	U-Fuse	Mack	530005	530005	46A	6 1/4 x 36 3/8	46A	6 1/4 x 36 3/8
284740	U-Fuse	International	530012	530012	38A	6 3/4 x 32 1/8	38A	6 3/4 x 32 1/8
284747	U-Fuse	Volvo Truck	530007	530007	56A	7 x 43 3/8	56A	7 x 43 3/8
284749	U-Fuse	Volvo Truck	530007	530007	56A	7 x 43 3/8	56A	7 x 43 3/8
284751	U-Fuse	Peterbuilt	530003	530003	42F	6 1/2 x 37 1/2	42F	6 1/2 x 37 1/2
284771	U-Fuse	Volvo Truck	530007	530007	56A	7 x 43 3/8	56A	7 x 43 3/8
284804	U-Fuse	International	530012	530012	38A	6 3/4 x 32 1/8	38A	6 3/4 x 32 1/8
284808	U-Fuse	Kenworth	530002	530002	40A	7 5/16 x 32 1/8	40A	7 5/16 x 32 1/8
284826	U-Fuse	International	530013	530013	38A	6 1/8 x 27 1/2	38A	6 1/8 x 27 1/2
284841	U-Fuse	Mack	530006	530006	48A	6 1/4 x 42	48A	6 1/4 x 42

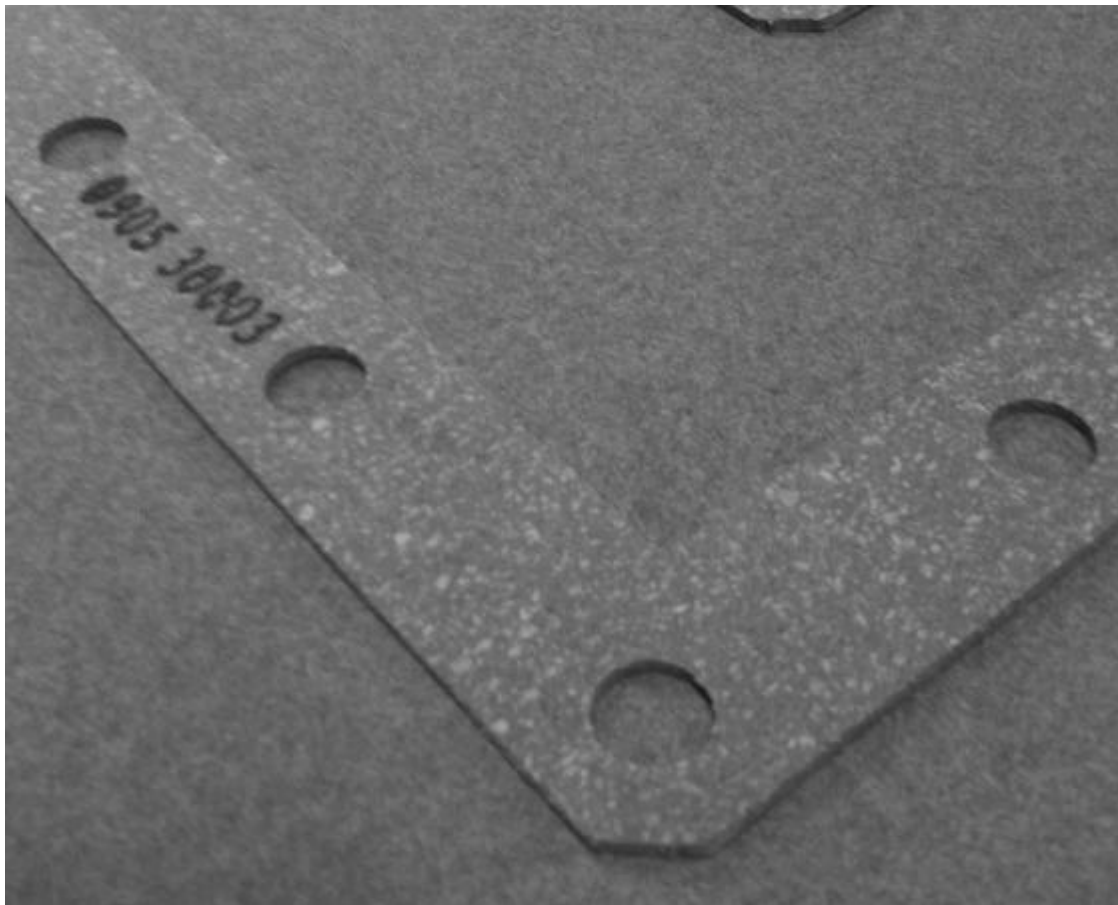



Application Table of Contents

Application Table of Contents

Adams Grader	51
Advance Mixer.....	51
Aero	51
Ajax.....	51
Alfa Romeo	51
AMC (also see Jeep, Chrysler, Renault).....	51-52
American LaFrance	52
Apollo	52
Atlas Copco.....	52
Audi	52-53
Austin.....	53
Autocar	53-54
Avery	54
Barber-Greene.....	54
Blaw Knox.....	54
Blue Bird Bus.....	54
BMW	54-55
Bombardier	55
Brockway	55
Brownhoist Tractor.....	55
Bucyrus Erie.....	55
Buick (also see Chevrolet, General Motors, Pontiac).....	55
Cadillac (also see Chevrolet, General Motors).....	55-56
Case/International.....	56-61
Caterpillar	61-80
Cat/LeMaster	80-83
Champion.....	83
Chevrolet (also see General Motors and specific model names)	83-85
Chrysler (also see Jeep, Dodge, Plymouth)	85-89
Cletrac	89
Climax	89
Continental.....	89
Crane Carrier.....	89
Crown Coach.....	90
Cummins.....	90-91
Datsun (also see Nissan)	91
Davey Compressor	91
David Brown Tractor	91
Detroit Diesel.....	92-94
Diamond Reo.....	94
Diehoe	94
Divco	94
Dodge	94-96
Dresser Industries	96-97
Drott.....	97
Dynahoe.....	98
Eagle Coach.....	98
Elgin.....	98
EMD Locomotive	98

Application Table of Contents

Euclid.....	98-99
F.W.D.....	99
Fairbanks-Morse	99
Fermont	99
Ferrari.....	99
Fiat.....	99
Fiat Allis	100-103
Firebird (also see Pontiac, General Motors).....	103-104
Flexible Bus.....	104
Ford	104-112
Ford Power Products.....	112
Ford Tractor	112-115
Ford Truck	115-120
Franklin Logger.....	120
Freightliner.....	120-121
Galion	121-122
Gardner Denver	122-123
General Electric	123
General Motors/Chevy Trucks (also see Chevrolet and specific model names).....	123-133
Gradall	133
Gremlin	133
Grove Worldwide.....	133-134
Hahn.....	134
Halliburton.....	134
Happy Young.....	134
Hendrickson Truck	134
Hercules Engine.....	134
Heston	134
Hobart Welder	134-135
Honda	135
Huber	135
Hyundai.....	135
Imperial.....	135
Ingersoll-Rand.....	135-136
International (also see Navistar)	136-138
International Harvester	138-142
Isuzu	143
Iveco Truck.....	143
Jaguar	143
Jeep (also see Chrysler, Plymouth, AMC).....	143-144
John Deere	145-155
Joy Manufacturing.....	155-156
Kenworth.....	156-158
Koehring.....	158
Kohler Engines	158
Komatsu.....	158-159
Kubota Tractor	159
LeRoi	159
LeTourneau.....	159

Application Table of Contents

Lift Trucks and Loaders (also search by make)	160-173
Lima Cranes	173
Lincoln	173
Lincoln Electric	173
Link-Belt	174
Lorain Shovel	174
Lufkin	174
Mack Trucks	174-178
Manitowoc	178-179
Marmon Truck	179
Massey-Ferguson	179-180
Matador	180
Maverick	180
Mazda	180-181
MB	181
Mercedes-Benz	181-182
Mercury	182
Metro Bus	182
MG	183
Military	183
Miller	183
Minneapolis Moline	183-184
Mitsubishi	184
Montgomery Ward	185
Morris	185
Motor Coach Ind (MCI)	185
Murphy Diesel	185
Mustang (also see Ford)	185
NABI Bus	185
Navistar (also see International)	185-192
Neoplan Bus	192
New Flyer Bus	192
Nissan (also see Datsun)	192-193
Nova Bus	193
Oldsmobile (also see Chevrolet, General Motors)	193
Oliver Hart Parr	193-195
Omni-Horizon	195
Onan	195
Opel	195
Orion Bus	195
Oshkosh	195-196
Ottawa Truck	196
P&H Manufacturing	196
Pacer	196
Packard	196
Peterbilt	196-199
Pettibone	199
Peugeot	199
Pierce Fire Truck	199

Application Table of Contents

Pinto	199
Plymouth	199
Pontiac (also see General Motors).....	199
Porsche	199
Quincy Compressor.....	199
Rambler	200
Rex	200
Rolls Royce.....	200
Rover	200
SAAB	200
Schramm	200
Seagrave	201
Speed Sprayer	201
Steiger Tractor.....	201
Studebaker.....	201
Subaru.....	201
Sullair	201-202
Sunbeam.....	202
Suzuki.....	202
Tempest.....	202
Terex.....	202
Terra-Gator.....	202
Thomas Bus.....	202
Timber Jack.....	202
Toro.....	202
Toronado.....	202
Toyota.....	203-204
Tree Farmer	204
Triumph.....	204
Truck and Bus Heater	204-205
V.M.E.	205
Valiant	205
Vega.....	205
Volkswagen	205
Volvo.....	205-208
Voss Bus	208
WABCO	208
Wagoner Tractor	208
Ward LaFrance.....	208
Waukesha	208-209
Western Star.....	209-210
White Tractor.....	210
Willys.....	210-211
Witte.....	211
Worthington	211

Core Listings

- By application



Vista-Pro Automotive - Core Catalog

(Cores Sorted by Application)

Height	Width	Depth	Application	Description	Fin Type	Fin Matl	Rows	FPI	BH/TH Type	BH/TH Width	BH/TH Length	BH/TH OHF	BH/TH Bolts	BH/TH Shape	Hdr Support	Part #
ADAMS GRADER																
24 5/8	28 11/16	3	ADAMS GRADER	HVY BTM HDR	T	C	4	10	BL BH	6 1/4 6 1/4	33 3/8 33 3/8	1 1/2 1 1/2	36 36	A A	C C	223025
ADVANCE MIXER																
32 1/4	31 1/4	2 7/8	ADVANCE MIXER	K75 CEMENT TRUCK	R	C	5	10	BL BL	9 1/2 6 5/8	33 33	3 5/16 1 7/8	50 46	A A	C C	226316
35	40	2 7/8	ADVANCE MIXER	K85 CEMENT TRUCK	R	C	5	10	BL BL	7 3/4 7 3/4	42 1/2 42 1/2	C C	54 54	A A	C C	226327
AERO																
29 1/2	22 1/2	2 7/8	AERO	SPRAYER	S	C	5	9	GR GR	3 1/2 3 1/2	22 1/2 22 1/2	C C		A A	C C	229005
AJAX																
15 3/4	15 5/8	2 1/4	AJAX	5 X 6 1/2	X	C	3	8	GR GR	3 1/2 3 1/2	16 1/2 16 1/2	1/8 1/8		A A	N N	221428
20	18 3/4	2 1/4	AJAX	6 1/2 X 8	X	C	3	8	GR GR	5 5	20 20	1/4 1/4		A A	N N	221427
20	18 3/4	2 3/8	AJAX		R	C	4	8	GR GR	5 5	20 20	FF FF		A A	N N	221472
20 1/8	18 3/4	2 15/16	AJAX		Z	C	4	7	GR GR	5 5	20 20	3/16 3/16		A A	N N	225260
25 1/8	25	3 11/16	AJAX		Z	C	5	10	GR GR	4 3/4 4 3/4	26 3/4 26 3/4	3/16 3/16		A A	C C	225261
25 1/8	25 5/8	3 9/16	AJAX	9 1/2 X 12	X	C	5	8	GR GR	4 3/4 4 3/4	26 3/4 26 3/4	1/4 1/4		A A	C C	221200
25 1/8	25 5/8	3 3/4	AJAX		X	C	5	8	SQ SQ	4 1/4 4 1/4	26 1/2 26 1/2	FF FF		A A	C C	222100
27	25 5/16	3 3/4	AJAX	11 X 14 CMA	T	C	5	8		6 3/4 6	25 3/4 25 3/4	1/4 1/4		0 0	C C	223027
28 1/2	28 1/8	3	AJAX	DPC-80	X	C	4	7	BL BL	7 7	31 31	C C	36 36	A A	C C	221211
28 1/2	28 1/8	3 3/4	AJAX		X	C	5	9	BL BL	6 7/8 6 7/8	31 1/8 31 1/8	1 7/16 1 7/16	30 30	A A	C C	221210
35 3/4	34 5/16	3 3/4	AJAX	11 X 15 DP-115 HVY BTM HDR	T	C	5	7	BL BH	6 3/4 6 3/4	38 38	C C	34 34	J J	C C	223001
35 3/4	34 5/16	3 3/4	AJAX	DP-115 HVY BTM HDR	T	C	5	7	BL BH	6 3/4 6 3/4	38 3/4 38 3/4	C C	44 44	A A	C C	223028
35 3/4	34 3/8	3	AJAX	11 X 15 HVY BTM HDR	X	C	4	7	BL BH	6 3/4 6 3/4	38 38	C C	34 34	J J	C C	274507
35 3/4	33 3/4	3	AJAX		X	C	4	7	BL BH	6 3/4 6 3/4	38 38	1 3/8 1 3/8	34 34	J J	C C	221201
39	35 5/8	4 7/16	AJAX	DP-160 HVY T/BTM HDRS BRASS FINS	Z	B	6	9	BH BH	7 1/2 7 1/2	39 39	C C	48 48	A A	C C	225263
ALFA ROMEO																
12 1/2	18 3/4	2 1/4	ALFA-ROMEO		X	C	3	8	GR GR	2 5/8 2 5/8	18 3/4 18 3/4	C C		A A	N N	265938
12 5/8	17 1/2	1 3/4	ALFA-ROMEO		R	C	3	11	GR GR	2 3/4 2	18 1/8 18 1/8	C C		A A	N N	265788
12 5/8	18 1/8	1 1/4	ALFA ROMEO		VT	C	2	16	GR GR	2 3/4 1 15/16	18 1/8 18 1/8	C C		A A	N N	128413
12 5/8	18 1/8	2	ALFA ROMEO		VT	C	3	12	GR FR	2 3/4 2 1/8	18 1/8 18 1/8	C C		A A	N N	128118
AMC																
13 3/4	19 13/16	2	AMC		VT	C	3	12	BX BX	2 2	19 5/8 19 5/8	C C		A A	N N	122273

Vista-Pro Automotive - Core Catalog

(Cores Sorted by Application)

Height	Width	Depth	Application	Description	Fin Type	Fin Matl	Rows	FPI	BH/TH Type	BH/TH Width	BH/TH Length	BH/TH OHF	BH/TH Bolts	BH/TH Shape	Hdr Support	Part #
AMC (Cont)																
14 1/2	18 11/16	1 1/4	AMC		VT	C	2	14	GR	3 1/4	19	C		A	N	122323
									GR	2 1/4	19	C		A		
14 5/8	24 3/16	1 1/4	AMC		VT	C	2	12	GR	2 13/16	24 5/8	FR		A	N	122283
									GR	1 3/4	24 5/8	FR		A		
14 5/8	24 3/16	1 1/4	AMC		VT	C	2	12	GR	2 13/16	24 5/8	C		A	N	122504
									GR	2	24 5/8	C		A		
14 5/8	24 3/16	1 1/4	AMC		VT	C	2	12	GR	2 13/16	24 5/8	C		A	N	124531
									GR	1 5/8	24 5/8	C		A		
14 5/8	24 3/16	1 1/4	AMC		VT	C	2	12	GR	2 13/16	24 5/8	5/8		A	N	124532
									GR	1 5/8	24 5/8	C		A		
14 5/8	24 3/16	2	AMC		VT	C	3	12	GR	2 13/16	24 5/8	FR		A	N	122325
									GR	2 1/4	24 5/8	C		A		
15 1/8	18 11/16	2	AMC		VT	C	3	12		2 7/8	18 1/4	1/8		0	N	128431
										2 1/8	18 1/2	C		0		
15 3/4	24 3/16	2	AMC		VT	C	3	12	GR	2 13/16	24 5/8	C		A	N	124575
									GR	2 1/4	24 5/8	C		A		
15 3/4	25 7/8	1 1/4	AMC		VT	C	2	12		2	25 9/16	3/8		0	N	128502
										2	25 9/16	3/8		0		
16 7/8	23 5/8	1 1/4	AMC		VT	C	2	12	GR	2 13/16	24 5/8	C		A	N	124573
									GR	1 3/4	24 5/8	C		A		
16 7/8	24 3/16	1 1/4	AMC		VT	C	2	12	GR	2 13/16	24 5/8	5/16		A	N	122487
									GR	2 1/4	24 3/4	C		A		
16 7/8	24 3/16	1 1/4	AMC		VT	C	2	12	GR	2 1/4	24 1/4	C		A	N	128433
									GR	2 1/4	24 1/4	C		A		
16 7/8	24 3/16	2	AMC		VT	C	3	12	GR	3 1/2	24 5/8	FF		A	N	122201
									GR	2 1/4	24 5/8	C		A		
16 7/8	24 3/4	1 1/4	AMC		VT	C	2	12	GR	2 13/16	24 5/8	1/4		A	N	128328
									GR	1 5/8	24 5/8	C		A		
18 7/8	24 3/16	2	AMC		VT	C	3	12	GR	4	24 3/4	FF		A	N	122202
									GR	3	24 3/4	C		A		
23 1/4	15 15/16	1 1/4	AMC		VT	C	2	12	GR	2 5/8	17 1/2	C		A	N	128449
									GR	2 5/8	17 1/2	C		A		
AM GENERAL																
24 3/8	27 1/2	2 7/8	AM GENERAL	HUMMER 6.2L DIESEL LOW FLOW DIMPLED TUBE	R	C	5	11	GR	3 5/16	27 5/8	C		A	C	226037
									GR	3 5/16	27 5/8	C		A		
33 1/4	31 1/4	3 7/16	AM GENERAL	5998599 HVY BTM HDR	R	C	6	11	BL	6 1/4	33 7/8	C	42	F	C	226323
									BH	6 1/4	33 7/8	C	42	F		
33 1/4	31 1/4	3 3/4	AM GENERAL	5998599 HVY BTM HDR	X	C	5	10	BL	6 1/4	33 7/8	C	42	F	CC	282458
									BH	6 1/4	33 7/8	C	42	F		
33 1/4	31 1/2	3 3/4	AM GENERAL	HVY BTM HDR	T	C	5	9	BL	6 1/4	33 7/8	C	42	A	C	223029
									BH	6 1/4	33 7/8	C	42	A		
AMERICAN LaFRANCE																
32 3/4	28 1/8	2 7/8	AMERICAN LaFRANCE	FIRE ENGINE	R	C	5	11	GR	4 3/4	28 1/4	C		A	C	226318
									GR	4 3/4	28 1/4	C		A		
APOLLO																
23	17 1/16	1 1/4	APOLLO		VT	C	2	12	GR	2 3/4	18 5/8	3/8		A	N	122559
									GR	2 3/4	18 5/8	3/8		A		
ATLAS COPCO																
26 1/4	13 3/4	2 3/8	ATLAS COPCO	175 CFM 13100310 71	S	C	4	10	GR	3 1/4	14 1/4	C		A	C	229136
									GR	3 1/4	14 1/4	C		A		
AUDI																
15 5/16	13 3/4	2	AUDI		VT	C	3	16	GR	2 3/8	13 7/8	C		A	N	128415
									GR	2 3/8	13 7/8	C		A		

Vista-Pro Automotive - Core Catalog

(Cores Sorted by Application)

Height	Width	Depth	Application	Description	Fin Type	Fin Matl	Rows	FPI	BH/TH Type	BH/TH Width	BH/TH Length	BH/TH OHF	BH/TH Bolts	BH/TH Shape	Hdr Support	Part #
AUDI (Cont)																
16 1/4	13 3/16	2	AUDI		VT	C	3	12	GR	2 3/8	13 1/8	C		A	N	124761
									GR	2 1/16	13 1/8	C		A	N	265789
18 3/4	14 3/8	1 1/4	AUDI		R	C	2	11	GR	2	15	C		A	N	265789
									GR	2	15	C		A	N	265789
AUSTIN																
10 5/8	10 7/16	2	AUSTIN		VT	C	3	12		2 1/8	11	C		0	N	128349
										2 1/8	11	C		0	N	128349
11 1/8	14 7/16	1 9/16	AUSTIN		VE	C	3	14	GR	4 7/8	14 13/16	3/16		A	N	128812
									GR	2 1/4	14 13/16	C		A	N	128812
11 1/4	14 7/8	2	AUSTIN		VT	C	3	12	GR	5	14 3/4	C		A	N	128329
									GR	2 1/4	14 3/4	C		A	N	128329
11 3/8	14 3/8	1 7/8	AUSTIN		X	C	2	11	GR	5	14 3/4	C		A	N	262882
									GR	2 1/4	14 3/4	C		A	N	262882
11 1/2	19 1/4	1 1/4	AUSTIN		VT	C	2	12	GR	1 7/8	19 5/16	C		A	N	128444
									GR	1 7/8	19 5/16	C		A	N	128444
13 3/4	18 9/16	3	AUSTIN		T	C	4	8		4 3/4	19 1/4	C		0	N	264123
										3 1/4	19 1/4	C		0	N	264123
14 1/2	10 11/16	1 1/2	AUSTIN		T	C	2	11		2	11	C		0	N	264326
										2	11	C		0	N	264326
16 7/8	15 3/16	2 1/4	AUSTIN		T	C	3	10	GR	4 1/2	16	3/8		A	N	264124
									GR	2 7/8	16	C		A	N	264124
17	15 3/8	2	AUSTIN		VT	C	3	14	GR	4 1/2	16	1/4		A	N	128336
									GR	2 7/8	16	1/4		A	N	128336
17 1/4	15 3/8	2	AUSTIN		VT	C	3	12	GR	4 1/2	16	1/4		A	N	128819
									GR	2 7/8	16	1/4		A	N	128819
23 5/8	19 13/16	2 5/8	AUSTIN		VT	C	4	12	GR	3 1/4	20 5/8	C		A	N	128445
									GR	3 1/4	20 5/8	C		A	N	128445
24 1/8	24 3/4	3	AUSTIN-WESTERN		T	C	4	8	GR	4 3/4	25 7/8	1/8		A	C	223035
									GR	4 1/8	25 7/8	1/8		A	C	223035
AUTOCAR																
27 3/4	40 5/8	2 3/8	AUTOCAR		R	C	4	11	BL	7 1/16	44 3/8	2 1/2	62	C	C	226180
									BL	7 1/16	44 3/8	2 1/2	62	C	C	226180
29	40 5/8	1 3/4	AUTOCAR		R	C	3	11	BL	7	43 3/8	C	56	A	CC	226208
									BL	7	43 3/8	C	56	A	CC	226208
30	32 1/2	2 3/8	AUTOCAR	TEMPLATE #2	R	C	4	11	BL	10	36 3/4	2 1/2	48	I	C	226267
									BL	6 5/8	36 1/8	2 1/2	46	C	C	226267
30	32 1/2	2 3/8	AUTOCAR	TEMPLATE #2	R	C	4	11	BL	10	36 3/4	1 1/4	48	I	C	226271
									BL	6 5/8	36 1/8	1 1/4	46	C	C	226271
30	32 1/2	2 7/8	AUTOCAR	TEMPLATE #2	R	C	5	10	BL	10	36 3/4	2 1/2	48	I	C	226102
									BL	6 5/8	36 1/8	2 1/2	46	C	C	226102
30	32 1/2	2 7/8	AUTOCAR	TEMPLATE #2	R	C	5	11	BL	10	36 3/4	1 1/2	48	I	C	226272
									BL	6 5/8	36 1/8	1 1/2	46	C	C	226272
32 1/2	40	3 7/16	AUTOCAR	HVY BTM HDR	R	C	6	11	BL	7 1/16	44 3/8	2 3/8	62	C	C	226274
									BH	7 1/16	44 3/8	2 3/8	62	C	C	226274
32 1/2	40	3 7/16	AUTOCAR	N-151918-DO4 HVY BTM HDR TEMPLATE #1	R	C	6	9	BL	10	45	2 3/8	60	I	C	226275
									BH	7 1/16	44 3/8	2 3/8	56	C	C	226275
32 1/2	40 1/2	3 3/4	AUTOCAR	HVY BTM HDR TEMPLATE #1	T	C	5	9	BL	10	45	2	60	I	CC	223043
									BH	7 1/16	44 3/8	2 1/2	56	C	C	223043
35 1/8	29 3/8	2 7/8	AUTOCAR	5GAB-090 CAN USE 281943	R	C	5	9	BL	10 3/8	31 1/4	3	54	B	C	226246
									BL	6	31 1/4	1 3/4	42	B	C	226246
35 3/8	27 1/2	1 3/4	AUTOCAR		R	C	3	11	BL	7	30 3/8	C	42	A	C	226280
									BL	7	30 3/8	C	42	A	C	226280
35 3/8	27 1/2	2 7/8	AUTOCAR		R	C	5	11	BL	7	30 3/8	1 11/16	42	A	C	226281
									BL	7	30 3/8	1 11/16	42	A	C	226281

Vista-Pro Automotive - Core Catalog

(Cores Sorted by Application)

Height	Width	Depth	Application	Description	Fin Type	Fin Matl	Rows	FPI	BH/TH Type	BH/TH Width	BH/TH Length	BH/TH OHF	BH/TH Bolts	BH/TH Shape	Hdr Support	Part #
AUTOCAR (Cont)																
35 7/8	40	3 7/16	AUTOCAR	HVY BTM HDR TEMPLATE #1	R	C	6	11	BL BH	10 7 1/16	45 44 3/8	2 2	60 56	I C	C	226282
AVERY																
13 1/4	13 1/2	2 1/4	AVERY		T	C	3	9	CR CR	4 7/8 2 1/4	13 1/2 13 1/2	3/16 C		A A	N	223044
14 1/2	15 3/16	2 1/4	AVERY		T	C	3	8	GR GR	6 2 1/2	15 3/4 15 3/4	1/4 1/4		A A	N	223045
BARBER-GREENE																
22 5/8	25 5/16	2 1/4	BARBER-GREENE		T	C	3	8	GR GR	5 1/4 4	25 1/2 25 1/2	1 7/8 1/2		A A	N	223005
24 7/8	24 3/4	2 1/4	BARBER-GREENE	3-53 DETROIT ENGINE	T	C	3	9	GR GR	4 3/4 4 3/4	25 1/2 25 1/2	C C		A A	C	223006
BLAW KNOX																
25	25	2 3/8	BLAW KNOX	ASPHALT SPREADER 164-659	S	C	4	9	GR GR	4 5/16 4 5/16	25 3/4 25 3/4	1/8 1/8		A A	C	229135
25	25	3 7/16	BLAW KNOX	PLANER 164-741	S	C	6	9	GR GR	4 5/16 4 5/16	25 3/4 25 3/4	C C		A A	C	229138
BLUE BIRD																
28	26 1/4	2 3/8	BLUE BIRD BUS		R	C	4	11	GR GR	8 1/4 4	26 7/8 26 7/8	1 7/16 5/16		A A	C	226320
28	26 1/4	2 7/8	BLUE BIRD BUS		R	C	5	10	GR GR	4 4	26 7/8 26 7/8	5/16 5/16		A A	C	226103
28	26 1/4	2 7/8	BLUE BIRD BUS		R	C	5	11	GR GR	8 1/4 4	26 7/8 26 7/8	1 7/16 3/8		A A	C	226290
28	26 1/4	2 7/8	BLUE BIRD BUS		R	C	5	11	GR GR	8 1/4 4	26 7/8 26 7/8	3/8 3/8		A A	C	226291
28	26 1/4	3 7/16	BLUE BIRD BUS		R	C	6	11	GR GR	4 4	26 7/8 26 7/8	5/16 5/16		A A	C	226295
30	26 1/4	2 7/8	BLUE BIRD BUS		R	C	5	11	GR GR	8 1/4 4	26 7/8 26 7/8	3/8 3/8		A A	C	226296
39 1/4	39 3/8	3 7/16	BLUE BIRD BUS		R	C	6	11	BL BL	6 7/8 6 7/8	41 1/4 41 1/4	C C	50 50	A A	C	226297
41 1/4	46 1/4	3 7/16	BLUE BIRD BUS	X-3190 E-2269 HVY BTM HDR	R	C	6	11	BL BH	6 7/8 6 7/8	48 1/4 48 1/4	C C	70 70	A A	CC	226894
BMW																
13 1/4	15 1/4	1	BMW		VE	C	2	14	GR GR	1 7/8 1 5/8	15 7/8 15 7/8	C C		A A	N	128221
13 1/4	15 3/8	1 1/4	BMW		VT	C	2	16	GR GR	1 7/8 1 5/8	15 7/8 15 7/8	C C		0 A	N	124811
13 1/4	15 3/8	2	BMW		VT	C	3	14	GR GR	2 1/16 2 1/16	15 3/4 15 3/4	C C		A A	N	128432
13 1/4	15 3/4	1 1/2	BMW		T	C	2	10		1 7/8 1 5/8	15 7/8 15 7/8	C C		0 0	N	265035
13 1/4	17 5/8	1 1/4	BMW		VT	C	2	12		1 7/8 1 5/8	18 18	C C		0 0	N	124908
13 3/8	15 11/16	1	BMW		VE	C	2	16	GR GR	1 7/8 1 5/8	15 7/8 15 7/8	C C		A A	N	128809
13 3/8	15 11/16	1 9/16	BMW		VE	C	3	16	GR SQ	1 7/8 1 5/8	15 7/8 15 7/8	C C		A A	N	122701
13 3/8	15 11/16	1 9/16	BMW		VE	C	3	14	GR GR	1 7/8 1 7/8	15 7/8 15 7/8	C C		A A	N	122702
13 3/8	15 15/16	1 1/4	BMW		VT	C	2	16	GR GR	1 7/8 1 7/8	15 7/8 15 7/8	C C		A A	N	124797
13 3/8	17 3/4	1 9/16	BMW		VE	C	3	16	SQ SQ	1 7/8 1 7/8	18 1/2 18 1/2	C C		A A	N	122339

Vista-Pro Automotive - Core Catalog

(Cores Sorted by Application)

Height	Width	Depth	Application	Description	Fin Type	Fin Matl	Rows	FPI	BH/TH Type	BH/TH Width	BH/TH Length	BH/TH OHF	BH/TH Bolts	BH/TH Shape	Hdr Support	Part #
BMW (Cont)																
22 3/4	18 11/16	1 1/4	BMW		VT	C	2	12	GR	2 1/8	18 1/2	C		A	N	124840
									GR	2 1/8	18 1/2	C		A		
22 3/4	18 11/16	1 1/4	BMW		VT	C	2	16	GR	2 5/16	18 1/2	3/16		A	N	124603
									GR	2 5/16	18 1/2	3/16		A		
22 3/4	18 11/16	2	BMW		VT	C	3	14		2 5/16	18 1/2	C		0	N	124909
										2 5/16	18 1/2	C		0		
BOMBARDIER																
25 3/8	19 1/8	3	BOMBARDIER		T	C	4	8		3 1/4	19 7/8	C		0	C	223051
										3 1/4	19 7/8	C		0		
BROCKWAY																
26 1/4	28 1/8	3 7/16	BROCKWAY		R	C	6	11	BL	7 3/8	30 1/4	C	42	A	C	226300
									BL	7 3/8	30 1/4	C	42	A		
28 1/2	23 3/4	2 3/8	BROCKWAY		R	C	4	11	GR	6 7/8	24 1/4	7/8		A	C	226302
									GR	3 5/8	24 1/4	7/8		A		
32 1/4	28 1/8	3 7/16	BROCKWAY		R	C	6	11	BL	7 3/8	30 1/4	C	42	A	C	226304
									BL	7 3/8	30 1/4	C	42	A		
BROWNHOIST																
17 3/4	17 7/16	2 1/4	BROWNHOIST	TRACTOR	T	C	3	8	GR	2 7/8	17 3/4	C		A	N	223057
									GR	2 7/8	17 3/4	C		A		
BUCYRUS ERIE																
27	27	2 1/4	BUCYRUS ERIE		T	C	3	7	BL	6 1/2	29	1 1/4	38	A	C	223059
									BL	6 1/2	29	1 1/4	38	A		
27	27	3 3/4	BUCYRUS ERIE	CRANE HVY T/BTM HDRS	T	C	5	8	BH	6 1/2	29	C	38	A	C	223060
									BH	6 1/2	29	C	38	A		
45	45	3 3/4	BUCYRUS ERIE	45R HVY T/BTM HDRS	T	C	5	11	BH	7 1/4	47 1/2	C	54	A	CC	223064
									BH	7 1/4	47 1/2	C	54	A		
BUICK																
12 1/4	23 1/8	2	BUICK		VT	C	3	12	GR	2 1/2	23 1/2	3/8		A	N	124560
									GR	2 1/4	23 1/2	C		A		
12 1/4	25 5/16	1 1/4	BUICK		VT	C	2	12	GR	2 3/4	25 7/16	C		A	N	122354
									GR	2 3/4	25 7/16	C		A		
15 1/2	18 11/16	1 1/4	BUICK		VT	C	2	12	GR	2 1/4	18 1/2	C		A	N	122363
									GR	2 1/4	18 1/2	C		A		
15 1/2	25 5/16	2	BUICK		VT	C	3	12	GR	3	25 7/16	C		A	N	122472
									GR	2 3/4	25 7/16	C		A		
20 3/8	14 7/8	1 1/4	BUICK		VT	C	2	16	GR	2 3/4	16 1/2	3/8		A	N	124830
									GR	2 1/16	16 1/2	3/8		A		
20 3/8	14 7/8	2	BUICK		VT	C	3	12	GR	2 3/4	16 1/2	C		A	N	124732
									GR	2 3/4	16 1/2	C		A		
20 3/4	17 1/16	2	BUICK		VT	C	3	12	GR	2 3/4	18 5/8	C		A	N	122413
									GR	2 3/4	18 5/8	C		A		
20 3/4	17 1/16	2 5/8	BUICK		VT	C	4	14	GR	3 1/2	18 5/8	C		A	N	122483
									GR	3 1/2	18 5/8	C		A		
26 3/8	17 1/16	1 1/4	BUICK		VT	C	2	12	GR	2 3/4	18 5/8	C		A	N	122520
									GR	2 3/4	18 5/8	C		A		
26 3/8	17 1/16	1 1/4	BUICK		VT	C	2	13	GR	2 3/4	18 5/8	3/8		A	N	124897
									GR	2 1/16	18 5/8	C		A		
28 1/4	17 1/16	1 1/4	BUICK		VT	C	2	13	GR	2 3/4	18 5/8	3/8		A	N	122516
									GR	2 3/4	18 5/8	3/8		A		
30 1/2	17 1/16	1 1/4	BUICK		VT	C	2	14	GR	2 3/4	18 5/8	3/8		A	N	124828
									GR	2 1/16	18 5/8	C		A		
CADILLAC																
17 3/8	25 5/16	1 1/4	CADILLAC		VT	C	2	12	GR	3	25 7/16	C		A	N	122450
									GR	2 3/4	25 7/16	C		A		

Vista-Pro Automotive - Core Catalog

(Cores Sorted by Application)

Height	Width	Depth	Application	Description	Fin Type	Fin Matl	Rows	FPI	BH/TH Type	BH/TH Width	BH/TH Length	BH/TH OHF	BH/TH Bolts	BH/TH Shape	Hdr Support	Part #
CADILLAC (Cont)																
30 1/2	17 1/16	2	CADILLAC		VT	C	3	14	GR	2 3/4	18 5/8	C		A	N	124829
									GR	2 3/4	18 5/8	C		A	N	124727
32 1/2	17 1/16	2	CADILLAC		VT	C	3	12	GR	2 3/4	18 5/8	C		A	N	124727
									GR	2 3/4	18 5/8	C		A	N	124727
CASE / INTERNATIONAL																
15	18 1/8	2 15/16	CASE/INTERNATIONAL		Z	C	4	7	GR	4	18 3/4	1		A	N	225313
									GR	4	18 3/4	1		A	N	225313
15	18 9/16	3	CASE/INTERNATIONAL	300, 350, 430	T	C	4	7	GR	4	18 3/4	1/8		A	N	223067
									GR	4	18 3/4	1/8		A	N	223067
15 1/4	18 1/8	2 15/16	CASE/INTERNATIONAL		Z	C	4	9	GR	4	18 3/4	3/16		A	N	225314
									GR	4	18 3/4	3/16		A	N	225314
15 3/4	15 3/4	2 1/4	CASE/INTERNATIONAL	430 TRACTOR	T	C	3	8	GR	6	15 7/8	1/4		A	N	223244
									GR	2 3/8	15 7/8	C		A	N	223244
15 7/8	15 5/8	2 3/16	CASE/INTERNATIONAL		Z	C	3	8	GR	5 7/8	15 3/4	3/16		A	N	225315
									GR	2 3/8	15 3/4	C		A	N	225315
16	15 3/4	2 1/4	CASE/INTERNATIONAL	300 DIESEL	T	C	3	7	GR	4 1/2	15 5/8	1/8		A	N	223009
									FR	2 3/8	15 5/8	C		A	N	223009
16	15 3/4	2 1/4	CASE/INTERNATIONAL	320	T	C	3	7	GR	4 1/4	15 5/8	1/4		A	N	262942
									GR	2 3/4	15 5/8	1/4		A	N	262942
16 1/4	15 5/8	2 1/4	CASE/INTERNATIONAL	320 LOADER	X	C	3	9	GR	4 1/4	15 5/8	3/16		A	N	281663
									GR	2 1/2	15 5/8	3/16		A	N	281663
16 1/4	18 1/8	2 15/16	CASE/INTERNATIONAL	310, 320	Z	C	4	7	GR	4	18 7/8	3/16		A	N	225316
									GR	4	18 7/8	3/16		A	N	225316
16 7/8	15 5/8	2 3/16	CASE/INTERNATIONAL		Z	C	3	9	GR	5 7/8	15 3/4	3/16		A	N	225317
									GR	2 1/2	15 3/4	3/16		A	N	225317
16 7/8	15 5/8	2 1/4	CASE/INTERNATIONAL		X	C	3	6	GR	5 7/8	15 1/2	1/4		A	N	265967
									GR	2 1/2	15 1/2	C		A	N	265967
16 7/8	15 3/4	2 1/4	CASE/INTERNATIONAL		T	C	3	7	GR	5 7/8	15 3/4	3/16		A	N	223010
									GR	2 1/2	15 3/4	3/16		A	N	223010
16 7/8	20 5/8	2 7/8	CASE/INTERNATIONAL	450	S	C	5	8	GR	3 3/8	21 3/4	C		A	N	266234
									GR	3 3/8	21 3/4	C		A	N	266234
16 7/8	21 1/4	2 1/4	CASE/INTERNATIONAL	450	X	C	3	8	GR	3 3/8	21 3/4	C		A	N	289087
									GR	3 3/8	21 3/4	C		A	N	289087
17	20 13/16	3	CASE/INTERNATIONAL	450 CRAWLER	T	C	4	8	GR	3 3/8	21 3/4	C		A	N	223105
									GR	3 3/8	21 3/4	C		A	N	223105
17 1/8	18 1/8	2 15/16	CASE/INTERNATIONAL	350 LOADER R-42415	Z	C	4	7	GR	4 1/4	18 3/4	1/8		A	N	225000
									GR	4 1/4	18 3/4	1/8		A	N	225000
17 1/4	15 3/4	2 1/4	CASE/INTERNATIONAL	500	T	C	3	8	GR	6	15 3/4	1/8		A	N	223012
									GR	2 1/2	15 3/4	C		A	N	223012
17 1/2	18 1/8	2 1/4	CASE/INTERNATIONAL		X	C	3	7	GR	5	18 3/8	1/8		A	N	266425
									FR	2 1/4	18 3/8	C		A	N	266425
17 5/8	18	2 1/4	CASE/INTERNATIONAL	541, W5G	T	C	3	9	GR	5	18 3/8	1/4		A	N	223106
									GR	2 5/8	18 3/8	1/4		A	N	223106
17 5/8	18 1/8	2 3/16	CASE/INTERNATIONAL	541	Z	C	3	10	GR	5	18 3/8	3/16		A	N	225320
									GR	2 5/8	18 3/8	3/16		A	N	225320
17 3/4	15 3/16	2 1/4	CASE/INTERNATIONAL	420, 600	T	C	3	9	GR	4 1/2	15 1/2	1/4		A	N	223013
									GR	2 1/2	15 1/2	C		A	N	223013
17 3/4	15 5/8	2 1/4	CASE/INTERNATIONAL	420, 600	X	C	3	10	GR	4 1/2	15 3/4	3/16		A	N	287863
									GR	2 1/2	15 3/4	3/16		A	N	287863
17 3/4	17 1/2	2 3/8	CASE/INTERNATIONAL		S	C	4	8	GR	5	18 3/8	1/4		A	N	229010
									GR	2 3/4	18 3/8	C		A	N	229010
18	17 1/2	2 1/4	CASE/INTERNATIONAL		X	C	3	7	GR	3	17 5/8	C		A	N	286861
									GR	3	17 5/8	C		A	N	286861
18	21 1/4	2 15/16	CASE/INTERNATIONAL	450B CRAWLER R-41126	Z	C	4	8	GR	5 7/8	21 7/8	1/4		A	N	225256
									GR	3 7/16	21 7/8	C		A	N	225256

Vista-Pro Automotive - Core Catalog

(Cores Sorted by Application)

Height	Width	Depth	Application	Description	Fin Type	Fin Matl	Rows	FPI	BH / TH Type	BH / TH Width	BH / TH Length	BH / TH OHF	BH / TH Bolts	BH / TH Shape	Hdr Support	Part #
CASE / INTERNATIONAL (Cont)																
18	21 7/8	2 7/8	CASE/INTERNATIONAL	450B CRAWLER R-46673	S	C	5	7	GR	5 7/8	21 7/8	1/4		A	N	229034
									GR	3 7/16	21 7/8	C		A		
18 1/4	23 1/16	3	CASE/INTERNATIONAL	190	T	C	4	8	GR	4	23 3/4	1/8		A	N	278762
									GR	4	23 3/4	1/8		A		
18 1/4	23 1/8	3 11/16	CASE/INTERNATIONAL		Z	C	5	10	GR	3 7/8	23 3/4	C		A	N	225321
									GR	3 7/8	23 3/4	C		A		
19	23 1/8	2 3/16	CASE/INTERNATIONAL	680E	Z	C	3	10	GR	6	23 7/8	3/16		A	N	225322
									GR	3 1/2	23 7/8	3/16		A		
19	23 1/8	3	CASE/INTERNATIONAL	680E	X	C	4	9	GR	6	23 7/8	1/4		A	N	266281
									GR	3 1/2	23 7/8	1/4		A		
19	23 1/8	3	CASE/INTERNATIONAL	680E	X	C	4	8	GR	6	23 7/8	3/16		A	N	286520
									GR	3 1/2	23 7/8	C		A		
19	23 5/8	2 1/4	CASE/INTERNATIONAL		T	C	3	9	GR	6	23 3/4	1/8		A	N	278764
									GR	3 1/2	23 3/4	1/8		A		
19	23 5/8	3	CASE/INTERNATIONAL	680E	T	C	4	8	GR	6	23 7/8	1/8		A	N	278763
									GR	3 1/2	23 7/8	1/8		A		
19	23 3/4	2 7/8	CASE/INTERNATIONAL	680 LOADER L-72507	S	C	5	8	GR	6	23 7/8	5/16		A	N	229147
									GR	3 1/2	23 7/8	C		A		
19	23 3/4	3	CASE/INTERNATIONAL	680E	X	C	4	8	GR	6	23 7/8	1/4		A	N	266282
									GR	3 1/2	23 7/8	C		A		
19 1/16	23 1/8	2 7/8	CASE/INTERNATIONAL	W-14 LOADER L-102723	S	C	5	8	GR	4 1/2	23 15/16	3/16		A	N	229144
									GR	4 1/2	23 15/16	3/16		A		
19 1/16	23 1/8	3 7/16	CASE/INTERNATIONAL	780B LOADER L-109155	S	C	6	8	GR	4 1/2	23 15/16	C		A	N	229145
									GR	4 1/2	23 15/16	C		A		
19 1/16	23 1/8	3 15/16	CASE/INTERNATIONAL	780B LOADER L-108998	S	C	7	8	GR	4 1/2	23 15/16	C		A	N	229146
									GR	4 1/2	23 15/16	C		A		
19 1/4	18 9/16	3	CASE/INTERNATIONAL	700-800	T	C	4	7	GR	6	19 1/2	3/16		A	N	275089
									GR	3 1/8	19 1/2	3/16		A		
19 1/4	18 3/4	3	CASE/INTERNATIONAL		X	C	4	8	GR	3 1/2	19 3/4	3/16		A	N	286537
									GR	3 1/2	19 3/4	3/16		A		
19 1/4	20	2 7/8	CASE/INTERNATIONAL	A-184253	S	C	5	8	GR	4 3/4	20 7/8	C		A	N	229149
									GR	4 3/4	20 7/8	C		A		
19 1/4	20	3 7/16	CASE/INTERNATIONAL	W-11 LOADER A-184256, A-171322	S	C	6	9	GR	4 3/4	20 7/8	1/2		A	N	229151
									GR	4 3/4	20 7/8	1/2		A		
19 1/4	20 5/8	2 3/8	CASE/INTERNATIONAL	1835-1845 A-184582, A-171080, A-171582, A-184250	S	C	4	9	GR	4 3/4	20 7/8	7/8		A	N	229152
									GR	4 3/4	20 7/8	7/8		A		
19 1/4	20 5/8	3 11/16	CASE/INTERNATIONAL	450B A-172867	Z	C	5	8	GR	4 3/4	20 7/8	1/8		A	N	225001
									GR	4 3/4	20 7/8	1/8		A		
19 1/4	20 5/8	3 15/16	CASE/INTERNATIONAL	A-184259	S	C	7	9	GR	4 3/4	20 7/8	C		A	N	229154
									GR	4 3/4	20 7/8	C		A		
19 1/4	23 1/2	3	CASE/INTERNATIONAL	W-14 LOADER	B	C	4	8	GR	4 1/2	24	1/8		A	N	229501
									GR	4 1/2	24	1/8		A		
19 3/8	14 3/8	2 1/4	CASE/INTERNATIONAL		X	C	3	8	GR	6	15 3/4	1/8		A	N	260548
									GR	2 3/8	15 3/4	C		A		
19 3/8	19 3/8	2 3/8	CASE/INTERNATIONAL	W-11 LOADER L-103034	S	C	4	8	GR	3 7/16	19 3/4	C		A	N	229155
									GR	3 7/16	19 3/4	C		A		
19 3/8	19 1/2	3	CASE/INTERNATIONAL	W-11 LOADER	B	C	4	8	GR	3 7/16	19 3/4	C		A	N	278767
									GR	3 7/16	19 3/4	C		A		
19 1/2	15 5/8	2 1/4	CASE/INTERNATIONAL		X	C	3	6	GR	6	15 3/4	1/16		A	N	260551
									GR	2 3/8	15 3/4	1/16		A		
19 1/2	23 1/16	3 3/4	CASE/INTERNATIONAL	DROTT BACKHOE	T	C	5	8	GR	4	23 3/4	C		A	N	223267
									GR	4	23 3/4	C		A		
19 1/2	25	2 7/8	CASE/INTERNATIONAL	MC4000 LIFT L-60005	S	C	5	7	GR	4 5/16	25 3/4	3/8		A	N	229156
									GR	4 5/16	25 3/4	3/8		A		

Vista-Pro Automotive - Core Catalog

(Cores Sorted by Application)

Height	Width	Depth	Application	Description	Fin Type	Fin Matl	Rows	FPI	BH/TH Type	BH/TH Width	BH/TH Length	BH/TH OHF	BH/TH Bolts	BH/TH Shape	Hdr Support	Part #
CASE / INTERNATIONAL (Cont)																
19 5/8	21 3/8	2 1/4	CASE/INTERNATIONAL	1842 U LOADER	T	C	3	7	GR	4	21 3/4	1 1/2		A	N	278770
									GR	4	21 3/4	1 1/2		A	N	
20 1/4	18 9/16	3	CASE/INTERNATIONAL	400	T	C	4	8	GR	6 1/8	19 1/2	1/4		A	N	223014
									GR	3 1/4	19 1/2	1/4		A	N	
20 1/4	19	3	CASE/INTERNATIONAL		B	C	4	6	GR	3 1/4	19 3/4	C		A	N	277125
									GR	3 1/4	19 3/4	C		A	N	
20 1/4	19 1/8	3	CASE/INTERNATIONAL		T	C	4	6	GR	3 1/4	19 3/4	C		A	N	263686
									GR	3 1/4	19 3/4	C		A	N	
20 1/2	15	2 3/16	CASE/INTERNATIONAL		Z	C	3	7	BL	5 5/8	17 1/2	2 3/8	16	F	C	225324
									BL	5 5/8	17 1/2	2 3/8	16	F	C	
20 1/2	15	3	CASE/INTERNATIONAL		X	C	4	7	BL	5 5/8	17 1/2	1 1/16	16	F	C	281061
									BL	5 5/8	17 1/2	1 1/16	16	F	C	
20 1/2	15 3/4	2 1/4	CASE/INTERNATIONAL	D, DC	T	C	3	8	BL	5 5/8	17 1/2	C	16	A	C	270089
									BL	5 5/8	17 1/2	C	16	A	C	
20 1/2	15 3/4	3	CASE/INTERNATIONAL	D, DC	T	C	4	7	BL	5 5/8	17 1/2	C	16	A	C	279292
									BL	5 5/8	17 1/2	C	16	A	C	
20 1/2	15 3/4	3 3/4	CASE/INTERNATIONAL		T	C	5	7	BL	5 5/8	17 1/2	C	16	A	C	223274
									BL	5 5/8	17 1/2	C	16	A	C	
20 5/8	18 1/8	3	CASE/INTERNATIONAL	W-12	X	C	4	9	GR	6	19 3/8	3/16		A	N	289922
									SQ	3 1/8	19 3/8	C		A	N	
20 7/8	24 3/8	2 7/8	CASE/INTERNATIONAL	W-18	S	C	5	9	GR	4 3/4	25 3/8	1/4		A	N	266275
									GR	4 3/4	25 3/8	1/4		A	N	
21	22 1/2	2 7/8	CASE/INTERNATIONAL	870 A-66331	S	C	5	7	GR	3 5/8	23	1/8		A	N	229164
									GR	3 5/8	23	1/8		A	N	
21 1/16	23 1/8	2 7/8	CASE/INTERNATIONAL	475 R-24765	S	C	5	8	GR	3 7/16	23 3/4	C		A	N	229169
									GR	3 7/16	23 3/4	C		A	N	
21 1/4	23 1/16	3	CASE/INTERNATIONAL		T	C	4	8	GR	3 7/8	23 3/4	C		A	N	278773
									GR	3 7/8	23 3/4	C		A	N	
21 1/4	23 1/8	3	CASE/INTERNATIONAL		X	C	4	8	GR	3 7/8	23 3/4	C		A	N	289923
									GR	3 7/8	23 3/4	C		A	N	
21 1/4	24 3/8	3	CASE/INTERNATIONAL	W-18 LOADER	X	C	4	9	GR	4 3/4	25 1/4	1/4		A	N	221824
									GR	4 3/4	25 1/4	1/4		A	N	
21 1/2	18 1/8	3	CASE/INTERNATIONAL	830	X	C	4	10	GR	3 1/4	18 3/8	C		A	N	221801
									GR	3 1/4	18 3/8	C		A	N	
21 5/8	17 1/2	2 7/8	CASE/INTERNATIONAL	830	S	C	5	8	GR	3 1/4	18 3/8	C		A	N	266273
									GR	3 3/4	18 3/8	C		A	N	
21 5/8	18 9/16	3	CASE/INTERNATIONAL	730, 740, 830	T	C	4	9	GR	6 1/8	19 5/8	1/4		A	N	262944
									GR	3 3/8	19 5/8	1/4		A	N	
21 5/8	18 9/16	3	CASE/INTERNATIONAL		T	C	4	7	GR	3 1/4	18 5/8	C		A	N	277345
									GR	3 1/4	18 5/8	C		A	N	
21 5/8	18 3/4	3	CASE/INTERNATIONAL	830, 840, 900	X	C	4	8	GR	6	19 5/8	3/16		A	N	221827
									GR	3 3/8	19 5/8	C		A	N	
21 3/4	26 7/8	2 7/8	CASE/INTERNATIONAL	W-9 LOADER L-10089	S	C	5	8	GR	4 1/4	27 1/4	1/8		A	N	229157
									GR	4 1/4	27 1/4	1/8		A	N	
22 1/2	18 1/8	3	CASE/INTERNATIONAL	930, 940	X	C	4	9	GR	3 1/4	18 3/4	1/8		A	N	266101
									GR	3 1/4	18 3/4	1/8		A	N	
22 1/2	18 1/8	3	CASE/INTERNATIONAL	930, 940	X	C	4	8	GR	3 1/4	18 3/4	C		A	N	288696
									GR	3 1/4	18 3/4	C		A	N	
22 1/2	18 1/2	3	CASE/INTERNATIONAL	930, 940	B	C	4	7	GR	3 1/4	18 3/4	3/16		A	N	277346
									GR	3 1/4	18 3/4	3/16		A	N	
22 1/2	23 1/16	3	CASE/INTERNATIONAL		T	C	4	8	GR	6	23 3/4	C		A	N	223015
									GR	3 1/2	23 3/4	C		A	N	
22 1/2	25	3 11/16	CASE/INTERNATIONAL	850 BRASS FINS	Z	B	5	8	GR	5 1/4	25	3/8		A	C	225616
									BL	7 1/8	27 1/2	1 1/4	36	A	C	

Vista-Pro Automotive - Core Catalog

(Cores Sorted by Application)

Height	Width	Depth	Application	Description	Fin Type	Fin Matl	Rows	FPI	BH/TH Type	BH/TH Width	BH/TH Length	BH/TH OHF	BH/TH Bolts	BH/TH Shape	Hdr Support	Part #
CASE / INTERNATIONAL (Cont)																
22 1/2	25	3 3/4	CASE/INTERNATIONAL	880 HVY BTM HDR BRASS FIN FACE DIPPED	B	B	5	7	SQ BH	5 1/4 7 1/8	25 27 3/4	1/4 1 3/8		A A	C	277126
22 1/2	25	3 3/4	CASE/INTERNATIONAL	850	X	C	5	8	GR BL	5 1/4 7 1/8	25 27 3/4	1 1/4 2 1/4	40	A A	C	286917
22 5/8	18	3	CASE/INTERNATIONAL	930	T	C	4	7	GR GR	6 3 1/4	19 3/8 19 3/8	1/8 C		A A	N	274991
22 3/4	9 3/8	3	CASE/INTERNATIONAL	LOADER	X	C	4	9		4 4	11 11	1/4 1/4		0 0	N	289429
22 3/4	18	3	CASE/INTERNATIONAL		T	C	4	9	GR GR	3 1/4 3 1/4	18 1/4 18 1/4	C C		A A	N	278782
22 3/4	18 1/8	2 15/16	CASE/INTERNATIONAL	930, 940	Z	C	4	11	GR GR	3 1/4 3 1/4	18 1/4 18 1/4	C C		A A	N	225331
22 7/8	18 3/4	3	CASE/INTERNATIONAL	26-40	X	C	4	7	BL BL	6 3/8 6 3/8	22 1/4 22 1/4	C C	18 18	S S	C	274571
22 7/8	19 3/8	3	CASE/INTERNATIONAL	L500	X	C	4	7	BL BL	6 3/8 6 3/8	22 1/4 22 1/4	1 1/4 1 1/4	18 18	S S	C	281440
23 3/4	22 1/2	3	CASE/INTERNATIONAL	1070	X	C	4	9	GR GR	3 3/4 3 3/4	22 7/8 22 7/8	C C		A A	N	278784
23 3/4	22 1/2	3	CASE/INTERNATIONAL	1070	X	C	4	9	GR GR	3 3/4 3 3/4	23 1/4 23 1/4	C C		A A	N	289700
23 3/4	22 1/2	3 7/16	CASE/INTERNATIONAL	1070	S	C	6	9	GR GR	3 3/4 3 3/4	22 7/8 22 7/8	C C		A A	N	229028
23 3/4	22 1/2	3 11/16	CASE/INTERNATIONAL	1370	Z	C	5	11		3 3/4 3 3/4	22 7/8 22 7/8	C C		0 0	N	225332
23 3/4	22 1/2	3 3/4	CASE/INTERNATIONAL	1270,1370, 2290 TRACTOR	T	C	5	9	FR FR	3 3/4 3 3/4	22 7/8 22 7/8	C C		0 0	N	223017
23 13/16	22 1/2	2 7/8	CASE/INTERNATIONAL	1270 A-64483	S	C	5	8	GR GR	3 5/8 3 5/8	23 23	1/8 1/8		A A	N	229158
23 13/16	22 1/2	3 7/16	CASE/INTERNATIONAL	2290 A-165922, A-66330	S	C	6	9	GR GR	3 5/8 3 5/8	23 23	C C		A A	N	229159
24	25	4 1/2	CASE/INTERNATIONAL	D1000 HVY BTM HDR BRASS FIN FACE DIPPED	B	B	6	7	GR BH	5 1/8 7 1/8	25 1/4 27 3/4	C C	40	A A	C	275088
24	25 5/16	4 1/2	CASE/INTERNATIONAL		T	C	6	9	GR BL	5 1/8 7 1/8	25 1/4 27 3/4	C C	40	A A	C	263354
24 1/16	24 3/8	4 7/16	CASE/INTERNATIONAL	1150-D LOADER BRASS FIN	Z	B	6	7	GR BL	5 1/8 7 1/8	25 27 3/4	C C	40	A A	C	225333
24 1/8	24 3/8	4 7/16	CASE/INTERNATIONAL	1150-D LOADER BRASS FIN	Z	B	6	7	GR BL	5 1/8 7 1/8	25 27 1/2	C C	36	A A	C	225334
24 3/8	27 9/16	3 3/4	CASE/INTERNATIONAL	1570	T	C	5	7	GR GR	4 3/16 4 3/16	28 1/4 28 1/4	C C		A A	C	272461
25	22 1/2	3 3/4	CASE/INTERNATIONAL	850-B LOADER BRASS FIN	T	B	5	6	BL BL	7 1/4 7 1/4	25 25	1 3/4 1 3/4	30 30	A A	C	265611
25	22 1/2	3 3/4	CASE/INTERNATIONAL		X	C	5	6	BL BL	7 1/4 7 1/4	25 25	1 3/4 1 3/4	30 30	A A	C	281633
25	22 1/2	4 1/2	CASE/INTERNATIONAL	850-B LOADER HVY BTM HDR BRASS FIN FACE DIPPED	B	B	6	7	BL BH	7 1/4 7 1/4	25 25	C C	30 30	A A	C	272462
25 3/8	18	3 3/4	CASE/INTERNATIONAL		T	C	5	9	GR GR	5 4	18 3/8 18 3/8	1/8 1/8		A A	C	278786
25 5/8	24 3/4	3 3/4	CASE/INTERNATIONAL		T	C	5	8	BL BL	6 5/8 6 5/8	27 1/2 27 1/2	1 1/4 1 1/4	34 34	A A	C	272788
25 7/8	29 1/2	3 3/4	CASE/INTERNATIONAL	825 SKIDDER	B	C	5	7	GR GR	4 7/8 4 7/8	29 3/4 29 3/4	C C		A A	C	278787
26 1/8	30	3 15/16	CASE/INTERNATIONAL	4690 TRACTOR A-149542	S	C	7	8	GR GR	4 7/16 4 7/16	31 1/16 31 1/16	C C		A A	C	229165

Vista-Pro Automotive - Core Catalog

(Cores Sorted by Application)

Height	Width	Depth	Application	Description	Fin Type	Fin Matl	Rows	FPI	BH / TH Type	BH / TH Width	BH / TH Length	BH / TH OHF	BH / TH Bolts	BH / TH Shape	Hdr Support	Part #
CASE / INTERNATIONAL (Cont)																
26 1/4	18 1/8	3 3/4	CASE/INTERNATIONAL	1030	X	C	5	8	GR	5	18 3/8	C		A	C	266168
									GR	4	18 3/8	C		A		
26 1/4	18 1/8	3 3/4	CASE/INTERNATIONAL	1370	X	C	5	9	GR	5	18 3/8	3/16		A	C	289166
									GR	4	18 3/8	3/16		A		
26 1/4	27 1/2	2 3/8	CASE/INTERNATIONAL	A-184453, A-189085, A-190657	S	C	4	9	GR	4 3/4	28 1/4	7/8		A	C	229160
									GR	4 3/4	28 1/4	7/8		A		
26 1/4	27 1/2	2 7/8	CASE/INTERNATIONAL	1085-C A-189217, A-189087	S	C	5	8	GR	4 3/4	28 1/4	C		A	C	229161
									GR	4 3/4	28 1/4	C		A		
26 1/4	27 1/2	3 7/16	CASE/INTERNATIONAL	2590, 2390 A-189089 A-172192	S	C	6	9	GR	4 3/4	28 1/4	3/8		A	C	229162
									GR	4 3/4	28 1/4	3/8		A		
26 1/4	27 1/2	3 15/16	CASE/INTERNATIONAL	A-189091 A-190663	S	C	7	9	GR	4 3/4	28 1/4	C		A	C	229163
									GR	4 3/4	28 1/4	C		A		
26 1/4	27 1/2	4 7/16	CASE/INTERNATIONAL	621 LOADER A-190619 BRASS FINS	Z	B	6	7	GR	4 3/4	28 1/4	C		A	C	225002
									GR	4 3/4	28 1/4	C		A		
26 5/8	27 1/2	2 7/8	CASE/INTERNATIONAL	2470 A-75526	S	C	5	8	GR	4 1/4	28 1/4	C		A	C	229148
									GR	4 1/4	28 1/4	C		A		
26 5/8	27 1/2	3 7/16	CASE/INTERNATIONAL	4490 A-166306	S	C	6	9	GR	4 1/4	28 1/4	C		A	C	229166
									GR	4 1/4	28 1/4	C		A		
26 5/8	27 1/2	3 3/4	CASE/INTERNATIONAL		B	C	5	10	GR	4 1/4	28 1/4	C		A	C	229524
									GR	4 1/4	28 1/4	C		A		
26 5/8	30	3 15/16	CASE/INTERNATIONAL	2670 TRACTOR A-160204	S	C	7	8	GR	4 3/8	31 1/16	C		A	C	229167
									GR	4 3/8	31 1/16	C		A		
26 5/8	30 3/8	3 3/4	CASE/INTERNATIONAL	2670 TRACTOR	T	C	5	10	GR	4 3/8	31 1/16	C		A	C	278789
									GR	4 3/8	31 1/16	C		A		
26 3/4	27 1/2	3	CASE/INTERNATIONAL	2470 TRACTOR	X	C	4	8	GR	4 1/4	28 1/2	C		A	C	221802
									GR	4 1/4	28 1/2	C		A		
26 3/4	27 1/2	3	CASE/INTERNATIONAL	2470 TRACTOR	X	C	4	7	GR	4 1/4	28 1/2	C		A	C	265898
									GR	4 1/4	28 1/2	C		A		
26 3/4	27 9/16	3	CASE/INTERNATIONAL	2470 TRACTOR	T	C	4	8	GR	4 1/4	28 1/2	C		A	C	223108
									GR	4 1/4	28 1/2	C		A		
27	27 1/2	3 7/16	CASE/INTERNATIONAL	A-50914	S	C	6	8	GR	4 1/4	28 1/4	1/4		A	C	229168
									GR	4 1/4	28 1/4	1/4		A		
27	27 1/2	3 3/4	CASE/INTERNATIONAL		X	C	5	11	GR	4 1/4	28 1/4	C		A	C	221803
									GR	4 1/4	28 1/4	C		A		
27	27 9/16	3 3/4	CASE/INTERNATIONAL		T	C	5	10	GR	4 1/4	28 1/4	C		A	C	223109
									GR	4 1/4	28 1/4	C		A		
27 1/4	26 7/8	2 3/8	CASE/INTERNATIONAL		S	C	4	8	GR	5	28	C		A	C	266271
									GR	5	28	C		A		
27 3/8	24 3/8	3	CASE/INTERNATIONAL		X	C	4	9	GR	4 3/4	25 1/2	3/16		A	C	282657
									GR	4 7/8	25 1/2	3/16		A		
27 3/8	24 3/8	4 5/8	CASE/INTERNATIONAL		X	C	6	8	GR	4 3/4	25 1/2	C		A	C	266270
									GR	4 7/8	25 1/2	C		A		
27 1/2	25	3	CASE/INTERNATIONAL	W-20C LOADER	X	C	4	10	GR	3 7/8	25 3/4	3/16		A	C	282474
									GR	3 7/8	25 3/4	3/16		A		
27 1/2	25 5/8	4 7/16	CASE/INTERNATIONAL	1150-B BRASS FINS	Z	B	6	7	BL	7	28	C	42	A	C	225337
									BL	7	28	C	42	A		
27 1/2	25 7/8	4 1/2	CASE/INTERNATIONAL	1150-B	T	C	6	9	BL	7	28	C	42	A	C	265485
									BL	7	28	C	42	A		
27 1/2	26	4 1/2	CASE/INTERNATIONAL	1150-B HVY BTM HDR BRASS FINS FACE DIPPED	B	B	6	8	BL	7	28	C	42	A	C	278794
									BH	7	28	C	42	A		
27 1/2	26 1/4	4 5/8	CASE/INTERNATIONAL	1150-B HVY T/BTM HDRS	X	C	6	7	BH	7	28	C	42	A	C	266182
									BH	7	28	C	42	A		
27 15/16	25	4 7/16	CASE/INTERNATIONAL	1420, 1440 COMBINE 55650-C3 107668 C3 BRASS FINS	Z	B	6	6	GR	5 7/8	25 7/8	C		A	C	225003
									GR	5 7/8	25 7/8	C		A		

Vista-Pro Automotive - Core Catalog

(Cores Sorted by Application)

Height	Width	Depth	Application	Description	Fin Type	Fin Matl	Rows	FPI	BH / TH Type	BH / TH Width	BH / TH Length	BH / TH OHF	BH / TH Bolts	BH / TH Shape	Hdr Support	Part #
CASE / INTERNATIONAL (Cont)																
28 3/4	18	4 1/2	CASE/INTERNATIONAL	1150-D CRAWLER HVY T/BTM HDRS	T	C	6	8	BH BH	7 1/2 7 1/2	21 1/4 21 1/4	C C	30 30	A A	C	272790
30 1/4	30	4 7/16	CASE/INTERNATIONAL	W-36 BRASS FINS	Z	B	6	9	GR GR	5 5	31 31	C C		A A	C	225339
30 1/2	16 1/4	4 7/16	CASE/INTERNATIONAL	850-D LOADER R-49826 BRASS FINS	Z	B	6	9	BL BL	7 1/2 7 1/2	18 3/8 18 3/8	C C	30 30	A A	C	225005
31 1/16	17 1/2	4 7/16	CASE/INTERNATIONAL	1150-E, 1155-E R-52599E BRASS FINS NOTCH T/HDR 1 CRNR	Z	B	6	9	BL BL	7 1/2 7 1/2	20 20	C C	32 32	A A	C	225006
31 1/8	27 1/2	2 7/8	CASE/INTERNATIONAL	621, 821 LOADER A-189363, A-189024	S	C	5	7	GR GR	4 3/4 4 3/4	28 1/4 28 1/4	C C		A A	C	229153
31 1/8	27 1/2	3 7/16	CASE/INTERNATIONAL	721 A-189365	S	C	6	6	GR GR	4 3/4 4 3/4	28 1/4 28 1/4	C C	3/8 3/8	A A	C	229170
31 1/8	27 1/2	4 7/16	CASE/INTERNATIONAL	821 LOADER A-190623 BRASS FINS	Z	B	6	7	GR GR	4 3/4 4 3/4	28 1/4 28 1/4	C C		A A	C	225007
31 3/4	30 5/8	3 15/16	CASE/INTERNATIONAL	9250, 9260	S	C	7	9	GR GR	5 13/16 5 13/16	31 7/16 31 7/16	C C		A A	C	229171
32	27	4 1/2	CASE/INTERNATIONAL	1450 CRAWLER HVY T/BTM HDRS BRASS FINS FACE DIPPED	B	B	6	7	BH BH	7 1/8 7 1/8	28 7/8 28 7/8	C C	38 38	A A	C	278795
32	27 1/2	4 7/16	CASE/INTERNATIONAL	1450 CRAWLER HVY T/BTM HDRS BRASS FINS	Z	B	6	7	BH BH	7 1/8 7 1/8	28 7/8 28 7/8	C C	38 38	A A	C	225341
32 1/4	28 11/16	3 3/4	CASE/INTERNATIONAL	4890, 4WD HVY BTM HDR	T	C	5	9	BL BH	10 1/4 6 1/8	31 1/2 31 1/2	C C	1 3/8 42	46 A	C	272789
32 1/4	29 13/16	3 3/4	CASE/INTERNATIONAL	4890, 4WD HVY T/BTM HDRS	T	C	5	9	BH BH	6 3/8 6 3/8	31 7/8 31 7/8	C C	48 48	A A	C	272587
32 1/2	30 5/8	3 7/16	CASE/INTERNATIONAL	1620 1979553-C1, A-189018	S	C	6	6	GR GR	5 13/16 5 13/16	31 7/16 31 7/16	C C	3/8 3/8	A A	C	229203
32 1/2	30 5/8	4 7/16	CASE/INTERNATIONAL	1640-1660 84576-C1 A-189069 BRASS FINS	Z	B	6	6	GR GR	5 13/16 5 13/16	31 7/16 31 7/16	C C	5/8 5/8	A A	C	225008
32 3/4	25	4 7/16	CASE/INTERNATIONAL	1470, 1480 COMBINE 130869-C2 146529-C2 BRASS FINS	Z	B	6	6	GR GR	5 7/8 5 7/8	25 3/4 25 3/4	C C		A A	C	225011
35 13/16	20 1/2	4 1/2	CASE/INTERNATIONAL	1450 CRAWLER HVY T/BTM HDRS BRASS FINS FACE DIPPED	B	B	6	7	BH BH	7 5/8 7 5/8	22 3/8 22 3/8	C C	32 32	A A	C	272465
35 13/16	20 5/8	4 7/16	CASE/INTERNATIONAL	1020 N-6653 R-49975 BRASS FINS	Z	B	6	9	BL BL	7 5/8 7 5/8	22 3/8 22 3/8	C C	34 34	A A	C	225012
37 9/16	25	3 11/16	CASE/INTERNATIONAL	1822 A-189203	Z	C	5	6	GR GR	5 7/8 5 7/8	25 3/4 25 3/4	C C		A A	C	225015
37 9/16	25	5 3/16	CASE/INTERNATIONAL	1844 1979366-C1 BRASS FINS	Z	B	7	6	GR GR	5 7/8 5 7/8	25 3/4 25 3/4	C C		A A	C	225016
CATERPILLAR																
16 5/8	18 1/8	3 3/4	CATERPILLAR	LIFT TRUCK	X	C	5	9		3 7/8 3 7/8	17 7/8 17 7/8	C C		0 0	N	266237
17 1/8	14 5/8	2 1/4	CATERPILLAR	TD-40	T	C	3	6	GR GR	5 7/8 2 3/8	15 3/4 15 3/4	C C	1/4	A A	N	265624
19 1/2	16 7/8	4 1/2	CATERPILLAR	LIFT TRUCK	T	C	6	9	GR GR	6 6	18 18	C C	1/4 1/4	A A	N	265671
20 3/8	20 5/8	2 1/4	CATERPILLAR		X	C	3	6	BL BL	4 1/8 4 1/8	22 7/8 22 7/8	C C	24 24	SS SS	C	265971
20 5/8	21 1/4	2 7/8	CATERPILLAR	PAVER 5E9014	S	C	5	9	GR GR	3 7/16 3 7/16	21 7/8 21 7/8	C C		A A	N	229174
20 7/8	20 5/8	2 15/16	CATERPILLAR	D-4 1S364 HVY T/BTM HDRS	Z	C	4	7	BH BH	5 5/8 5 5/8	23 23	C C	24 24	A A	C	225035

Vista-Pro Automotive - Core Catalog

(Cores Sorted by Application)

Height	Width	Depth	Application	Description	Fin Type	Fin Matl	Rows	FPI	BH / TH Type	BH / TH Width	BH / TH Length	BH / TH OHF	BH / TH Bolts	BH / TH Shape	Hdr Support	Part #
CATERPILLAR (Cont)																
20 7/8	20 5/8	2 15/16	CATERPILLAR	D-4 1S364 HVY T/BTM HDRS HVY STEEL FINS	Z	S	4	7	BH BH	5 5/8 5 5/8	23 23	C C	24 24	A A	C	225801
20 7/8	21	3	CATERPILLAR	D-4 HVY T/BTM HDRS BRASS FINS	B	B	4	7	BH BH	5 5/8 5 5/8	23 23	C C	24 24	A A	C	229581
20 15/16	42 1/2	4 7/16	CATERPILLAR	D353 5L4384 HVY T/BTM HDRS BRASS FINS	Z	B	6	9	BH BH	8 8	43 7/8 43 7/8	C C	52 52	A A	C	225021
20 15/16	42 1/2	4 1/2	CATERPILLAR	D353 HVY T/BTM HDRS BRASS FINS FACE DIPPED	B	B	6	7	BH BH	8 8	43 7/8 43 7/8	1 1/2 1 1/2	52 52	A A	C	274989
21 1/16	21	3	CATERPILLAR	D-4 HVY BTM HDR BRASS FINS	B	B	4	7	BL BH	5 5/16 5 5/16	27 7/8 27 7/8	C C	26 26	A A	C	229659
21 3/4	21 1/4	4 7/16	CATERPILLAR	910 LOADER 8N4077 BRASS FINS	Z	B	6	9	GR GR	4 7/8 4 7/8	22 1/8 22 1/8	C C		A A	N	225129
21 3/4	21 1/4	4 5/8	CATERPILLAR	910 LOADER 8N4077	X	C	6	6		4 7/8 4 7/8	22 1/8 22 1/8	C C		0 0	N	266293
21 3/4	21 3/8	4 1/2	CATERPILLAR	910 LOADER	T	C	6	9	GR GR	4 7/8 4 7/8	22 1/8 22 1/8	1/4 1/4		A A	N	265628
21 3/4	21 1/2	4 1/2	CATERPILLAR	910 LOADER 8N4077 BRASS FINS FACE DIPPED	B	B	6	9	GR GR	4 7/8 4 7/8	22 1/8 22 1/8	C C		A A	N	229525
21 3/4	21 1/2	4 1/2	CATERPILLAR	910 LOADER 8N4077 BRASS FINS	B	B	6	9	GR GR	4 7/8 4 7/8	22 1/8 22 1/8	C C		A A	N	229584
22	22 1/2	2 1/4	CATERPILLAR	D-3	T	C	3	8	GR GR	4 3/4 4 3/4	22 3/4 22 3/4	C C		A A	N	265629
22	22 1/2	3	CATERPILLAR	D-2	T	C	4	8	GR GR	4 3/4 4 3/4	22 3/4 22 3/4	1/4 1/4		A A	N	265630
22 1/4	24 3/8	2 7/8	CATERPILLAR	D-4 2A684	S	C	5	6	BL BL	5 3/8 5 3/8	27 1/4 27 1/4	C C	28 28	H H	C	229175
22 5/8	18	2 1/4	CATERPILLAR	D-2 HVY BTM HDR OFFSET FOR O/C	T	C	3	8	BL BH	5 1/4 5 1/4	25 1/4 25 1/4	C C	28 28	H H	C	265631
22 5/8	18	3	CATERPILLAR	D-2 HVY BTM HDR OFFSET FOR O/C	T	C	4	9	BL BH	5 1/4 5 1/4	25 1/4 25 1/4	C C	28 28	H H	C	265632
22 5/8	18 1/8	2 15/16	CATERPILLAR	D-2 8F3135 HVY T/BTM HDRS OFFSET FOR O/C	Z	C	4	6	BH BH	5 1/4 5 1/4	25 1/4 25 1/4	C C	28 28	H H	C	225026
22 5/8	22 1/2	2 3/16	CATERPILLAR	933 LOADER 3S9307 HVY T/BTM HDRS	Z	C	3	8	BH BH	4 1/2 4 1/2	25 3/8 25 3/8	C C	24 24	F F	C	225031
22 5/8	22 1/2	2 15/16	CATERPILLAR	922B 1S1386 HVY T/BTM HDRS	Z	C	4	6	BH BH	5 3/8 5 3/8	25 1/8 25 1/8	C C	24 24	F F	C	225036
22 5/8	22 1/2	3	CATERPILLAR	922B HVY BTM HDR	T	C	4	7	BL BH	5 3/8 5 3/8	25 1/8 25 1/8	C C	24 24	A A	C	270103
22 5/8	24 1/2	3	CATERPILLAR	922 LOADER 4M114 HVY BTM HDR BRASS FINS FACE DIPPED	B	B	4	7	BL BH	5 5	26 26	C C	24 24	A A	C	275091
23 7/16	24 3/16	3	CATERPILLAR	12 GRADER HVY BTM HDR	T	C	4	7	BL BH	5 3/4 5 3/4	26 9/16 26 9/16	C C	24 24	H H	C	271472
23 7/16	24 3/16	3	CATERPILLAR	D-4 HVY BTM HDR	T	C	4	7	BL BH	5 3/4 5 3/4	26 5/8 26 5/8	C C	24 24	T T	C	274602
23 7/16	24 3/8	2 15/16	CATERPILLAR	D-4 9H4771 HVY T/BTM HDRS	Z	C	4	7	BH BH	5 3/4 5 3/4	26 5/8 26 5/8	C C	24 24	N N	C	225039
23 7/16	24 3/8	2 15/16	CATERPILLAR	D-4 2A1164 HVY T/BTM HDRS	Z	C	4	6	BH BH	5 3/4 5 3/4	26 5/8 26 5/8	1 1/8 1 1/8	24 24	GG GG	C	225230
23 1/2	18 3/4	2 3/16	CATERPILLAR	D-4 4F7979 OFFSET FOR O/C	Z	C	3	9	BL BL	5 3/4 5 3/4	26 5/8 26 5/8	2 3/16 2 3/16	24 24	N N	C	225038
23 1/2	18 3/4	2 15/16	CATERPILLAR	D-4 4A2577 HVY BTM HDR OFFSET FOR O/C	Z	C	4	6	BL BH	5 3/4 5 3/4	26 5/8 26 5/8	1 1/16 1 1/16	24 24	N N	C	225042

Vista-Pro Automotive - Core Catalog

(Cores Sorted by Application)

Height	Width	Depth	Application	Description	Fin Type	Fin Matl	Rows	FPI	BH/TH Type	BH/TH Width	BH/TH Length	BH/TH OHF	BH/TH Bolts	BH/TH Shape	Hdr Support	Part #
CATERPILLAR (Cont)																
23 7/8	24 3/4	2 1/4	CATERPILLAR		T	C	3	8	GR GR	4 1/4 4 1/4	25 3/4 25 3/4	C C		A A	N	265637
25	24 3/4	3	CATERPILLAR	613 SCRAPER	T	C	4	9	GR GR	3 7/16 3 7/16	25 5/8 25 5/8	C C		A A	C	223018
25 1/8	26 1/4	3	CATERPILLAR	3208	X	C	4	10	GR GR	4 4	26 7/8 26 7/8	C C		A A	C	286717
25 3/8	24 3/16	3	CATERPILLAR	112 GRADER 7S584 HVY T/BTM HDRS	T	C	4	8	BH BH	5 3/8 5 3/8	28 3/8 25 3/8	C C	26 28	B A	C	265030
25 3/8	25 5/8	3	CATERPILLAR	112 GRADER HVY BTM HDR	X	C	4	8	BL BH	5 3/8 5 3/8	28 3/8 28 3/8	C C	26 26	DD DD	C	274939
25 1/2	26 7/16	2 1/4	CATERPILLAR	225 SHOVEL 3N2913	T	C	3	8	GR GR	4 4	26 7/8 26 7/8	C C		A A	C	223019
25 15/16	20 5/8	2 15/16	CATERPILLAR	12 GRADER 8F3136 HVY BTM HDR	Z	C	4	6	BL BH	5 3/4 5 3/4	28 5/8 28 5/8	C C	28 28	H H	C	225235
25 15/16	20 13/16	3	CATERPILLAR	12 GRADER OFFSET FOR O/C	T	C	4	7	BL BL	5 3/4 5 3/4	28 5/8 28 5/8	C C	28 28	H H	C	270095
26	27 1/2	2 3/16	CATERPILLAR	D-4D 5S8052 HVY T/BTM HDRS HVY STEEL FINS 4 CRNRS OF CORE NOTCHED	Z	S	3	6	BH BH	5 3/4 5 3/4	29 3/8 29 3/8	C C	32 32	F F	C	225857
26	27 1/2	2 15/16	CATERPILLAR	D-4 5S4592 HVY T/BTM HDRS 4 CRNRS OF CORE NOTCHED	Z	C	4	9	BH BH	5 3/4 5 3/4	29 3/8 28 7/8	C C	32 32	F F	C	225238
26	27 1/2	3	CATERPILLAR	D-4 HVY T/BTM HDRS	B	C	4	7	BH BH	5 3/4 5 3/4	29 3/8 29	C C	32 32	A A	C	278807
26	27 1/2	3 3/4	CATERPILLAR	D-4 HVY T/BTM HDRS BRASS FINS	B	B	5	6	BH BH	5 3/4 5 3/4	29 3/8 29	C C	32 32	A A	C	229585
26	27 9/16	3	CATERPILLAR	D-4 HVY T/BTM HDRS BRASS FINS	T	B	4	9	BH BH	5 3/4 5 3/4	29 3/8 29	C C	32 32	A A	C	264351
26	28 3/4	4 7/16	CATERPILLAR	7N561 BRASS FINS	Z	B	6	9	GR GR	6 6	29 1/2 29 1/2	C C		A A	C	225240
26 3/8	20	2 15/16	CATERPILLAR	GRADER BRASS FINS	Z	B	4	9	GR GR	3 1/2 3 1/2	22 22	C C		A A	C	225139
26 1/2	28 11/16	3	CATERPILLAR	D330	T	C	4	9	GR GR	4 4	29 1/2 29 1/2	1/4 1/4		A A	C	223624
26 3/4	24	3	CATERPILLAR	D-6 HVY T/BTM HDRS BRASS FINS FACE DIPPED T/HDR OFFSET	B	B	4	7	BH BH	8 1/2 6 9/16	33 24 1/8	2 3/8 C	28 24	Z A	C	278809
26 3/4	24	3 3/4	CATERPILLAR	D-6 POWER SHIFT 8H4432 HVY T/BTM HDRS BRASS FINS	B	B	5	7	BH BH	8 1/2 6 9/16	33 24 1/8	2 3/8 C	28 24	Z A	C	229586
26 3/4	24 3/8	2 15/16	CATERPILLAR	D-6 6H9008 HVY T/BTM HDRS 2 BTM CRNRS OF CORE NOTCHED	Z	C	4	8	BH BH	8 1/2 6 9/16	33 24 1/8	2 3/8 C	28 24	Z F	C	225241
26 3/4	24 3/8	3 11/16	CATERPILLAR	D-6 POWER SHIFT 8H4432 HVY T/BTM HDRS 2 BTM CRNRS OF CORE NOTCHED	Z	C	5	7	BH BH	8 1/2 6 9/16	33 24 1/8	2 3/8 C	28 24	Z F	C	225186
26 3/4	26 1/4	2 3/16	CATERPILLAR	D-6 2M4798 HVY T/BTM HDRS 4 CRNRS OF CORE NOTCHED	Z	C	3	9	BH BH	5 7/16 5 7/16	27 7/16 27 7/16	C C	26 26	F F	C	225242
26 3/4	26 1/4	2 15/16	CATERPILLAR	D-6, 561 2S739 HVY T/BTM HDRS BRASS FINS 4 CRNRS OF CORE NOTCHED	Z	B	4	7	BH BH	5 7/16 5 7/16	27 7/16 27 7/16	C C	26 26	F F	C	225134
26 3/4	26 7/16	3	CATERPILLAR	D-6 HVY T/BTM HDRS BRASS FINS 4 CRNRS OF CORE NOTCHED	T	B	4	6	BH BH	5 7/16 5 7/16	27 7/16 27 7/16	C C	26 26	F F	C	265028
26 3/4	26 1/2	3	CATERPILLAR	D-6 2S739 HVY T/BTM HDRS BRASS FINS FACE DIPPED 4 CRNRS OF CORE NOTCHED	B	B	4	7	BH BH	5 7/16 5 7/16	27 7/16 27 7/16	C C	26 26	F F	C	229522

Vista-Pro Automotive - Core Catalog

(Cores Sorted by Application)

Height	Width	Depth	Application	Description	Fin Type	Fin Matl	Rows	FPI	BH/TH Type	BH/TH Width	BH/TH Length	BH/TH OHF	BH/TH Bolts	BH/TH Shape	Hdr Support	Part #
CATERPILLAR (Cont)																
26 3/4	26 1/2	3	CATERPILLAR	D-6 2S739 HVY T/BTM HDRS BRASS FINNS 4 CRNRS OF CORE NOTCHED	B	B	4	7	BH BH	5 7/16 5 7/16	27 7/16 27 7/16	C	26	F	C	229587
26 3/4	27	3	CATERPILLAR	613 SCRAPER BRASS FINNS	B	B	4	7	GR GR	4 1/4 4 1/4	28 28	C		A	C	272557
26 3/4	28 11/16	2 1/4	CATERPILLAR	D330A 4L2114	T	C	3	9	GR GR	4 4	29 1/2 29 1/2	C		A	C	265645
26 3/4	28 11/16	3 3/4	CATERPILLAR	D330A	T	C	5	7	GR GR	4 4	29 5/8 29 5/8	C		A	C	223042
26 3/4	28 3/4	2 3/8	CATERPILLAR	D330A 4L2114	S	C	4	9	GR GR	4 4	29 1/2 29 1/2	C		A	C	223020
26 3/4	28 3/4	3 11/16	CATERPILLAR	D330A	Z	C	5	11	GR GR	4 4	29 1/2 29 1/2	C		A	C	225350
27 3/4	21 1/4	5 3/16	CATERPILLAR	951C 4N3474 HVY T/BTM HDRS HVY STEEL FINNS	Z	S	7	9	BH BH	7 5/16 7 5/16	23 11/16 23 11/16	C	26	F	C	225804
27 3/4	21 1/2	5 1/4	CATERPILLAR	951C LOADER HVY T/BTM HDRS BRASS FINNS FACE DIPPED	B	B	7	7	BH BH	7 5/16 7 5/16	23 11/16 23 11/16	C	26	F	C	272560
27 3/4	25 5/8	2 15/16	CATERPILLAR	941, 951 5S8036 HVY T/BTM HDRS	Z	C	4	9	BH BH	7 5/16 7 5/16	28 3/8 28 3/8	C	30	F	C	225244
27 3/4	25 5/8	3 11/16	CATERPILLAR	951 8S2640 HVY T/BTM HDRS BRASS FINNS	Z	B	5	9	BH BH	7 5/16 7 5/16	28 3/8 28 3/8	C	30	F	C	225135
27 3/4	25 5/8	3 11/16	CATERPILLAR	951 8S2640 HVY T/BTM HDRS HVY STEEL FINNS	Z	S	5	9	BH BH	7 5/16 7 5/16	28 3/8 28 3/8	C	30	F	C	225805
27 3/4	25 7/8	3 3/4	CATERPILLAR	941 HVY T/BTM HDRS	T	C	5	9	BH BH	7 5/16 7 5/16	28 3/8 28 3/8	C	30	F	F	266548
27 3/4	26	3 3/4	CATERPILLAR	941, 951 POWER SHIFT 8S2640 HVY T/BTM HDRS BRASS FINNS FACE DIPPED	B	B	5	6	BH BH	7 5/16 7 5/16	28 3/8 28 3/8	C	30	F	C	229532
27 3/4	26	3 3/4	CATERPILLAR	941, 951 POWER SHIFT 8S2640 HVY T/BTM HDRS BRASS FINNS	B	B	5	6	BH BH	7 5/16 7 5/16	28 3/8 28 3/8	C	30	F	C	229588
28	27 1/2	2 3/16	CATERPILLAR	D-4 2P4648 HVY T/BTM HDRS BRASS FINNS 4 CRNRS OF CORE NOTCHED	Z	B	3	7	BH BH	5 3/4 5 3/4	29 3/8 28 7/8	C	32	A	C	225245
28	27 1/2	2 15/16	CATERPILLAR	D-4E 8N3545 HVY T/BTM HDRS 4 CRNRS OF CORE NOTCHED	Z	C	4	8	BH BH	5 3/4 5 3/4	29 3/8 28 7/8	C	32	A	C	225246
28	27 1/2	3 11/16	CATERPILLAR	D-4E 4N8779 HVY T/BTM HDRS BRASS FINNS 4 CRNRS OF CORE NOTCHED	Z	B	5	9	BH BH	5 3/4 5 3/4	29 3/8 28 7/8	C	32	A	C	225247
28	27 1/2	3 11/16	CATERPILLAR	D-4E 7N6223 HVY T/BTM HDRS HVY STEEL FINNS 4 CRNRS OF CORE NOTCHED	Z	S	5	9	BH BH	5 3/4 5 3/4	29 3/8 28 7/8	C	32	A	C	225898
28	27 1/2	3 3/4	CATERPILLAR	D-4D HVY T/BTM HDRS BRASS FINNS	B	B	5	6	BH BH	5 3/4 5 3/4	29 3/8 28 7/8	C	32	A	C	229600
28 1/4	24	3 3/4	CATERPILLAR	12 GRADER HVY T/BTM HDRS BRASS FINNS FACE DIP T/HDR OFFSET FOR O/C	B	B	5	6	BH BH	8 1/2 6 5/8	33 24 1/8	C	28	Z	C	274204
28 1/4	24 3/8	2 15/16	CATERPILLAR	12 GRADER 6H9001 HVY T/BTM HDRS T OFFSET O/C 2 BTM CRNRS NOTCHED	Z	C	4	8	BH BH	8 1/2 6 5/8	33 24 1/8	2 1/8 C	28	Z	C	225248
28 1/4	24 3/8	4 7/16	CATERPILLAR	12 GRADER HVY T/BTM HDRS BRASS FINNS 2 BTM CRNRS NOTCHED T/HDR OFFSET O/C	Z	B	6	8	BH BH	8 1/2 6 5/8	33 24 1/8	2 1/2 1 1/4	28	Z	C	225158
28 1/4	26	3 3/4	CATERPILLAR	941, 951B HVY T/BTM HDRS BRASS FINNS	B	B	5	6	BH BH	7 5/16 7 5/16	28 3/8 28 3/8	C	30	A	C	229589

Vista-Pro Automotive - Core Catalog

(Cores Sorted by Application)

Height	Width	Depth	Application	Description	Fin Type	Fin Matl	Rows	FPI	BH/TH Type	BH/TH Width	BH/TH Length	BH/TH OHF	BH/TH Bolts	BH/TH Shape	Hdr Support	Part #
CATERPILLAR (Cont)																
28 1/4	29	3	CATERPILLAR	14 GRADER HVY T/BTM HDRS BRASS FINS FACE DIPPED	B	B	4	8	BH BH	5 1/2 5 1/2	32 9/16 29 5/16	C C	30 26	F F	C	229502
28 1/4	29	3	CATERPILLAR	14 GRADER HVY T/BTM HDRS BRASS FINS	B	B	4	7	BH BH	5 7/16 5 7/16	32 9/16 29 5/16	C C	30 26	F F	C	229590
28 1/4	29 3/8	2 3/16	CATERPILLAR	12 GRADER 9S4997, 7S1086 HVY T/BTM HDRS HVY STEEL FINS 2 BTM CRNRS OF CORE NOTCHED	Z	S	3	9	BH BH	5 7/16 5 7/16	32 9/16 29 5/16	C C	30 26	F F	C	225808
28 1/4	29 3/8	2 3/8	CATERPILLAR	920 LOADER HVY T/BTM HDRS	S	C	4	9	BH BH	5 1/2 5 1/2	32 3/4 29 3/8	C C	30 26	F F	C	266187
28 1/4	29 3/8	2 15/16	CATERPILLAR	14 GRADER 4N8248 HVY T/BTM HDRS 2 BTM CRNRS OF CORE NOTCHED	Z	C	4	9	BH BH	5 7/16 5 7/16	32 9/16 29 3/8	C C	30 26	F F	C	225119
28 1/4	29 3/8	2 15/16	CATERPILLAR	14 GRADER 4N8248 HVY T/BTM HDRS BRASS FINS 2 BTM CRNRS NOTCHED	Z	B	4	9	BH BH	5 7/16 5 7/16	32 9/16 29 3/8	C C	30 26	F F	C	225609
28 1/4	29 3/8	2 15/16	CATERPILLAR	14 GRADER 8N7857, 7S1085 HVY T/BTM HDRS HVY STEEL FINS 2 BTM CRNRS OF CORE NOTCHED	Z	S	4	9	BH BH	5 7/16 5 7/16	32 9/16 29 5/16	C C	30 26	F F	C	225835
29 1/4	16 1/4	3 11/16	CATERPILLAR	943 LOADER 8N184 4 CRNRS OF CORE NOTCHED	Z	C	5	9	GR GR	6 1/2 6 1/2	16 5/8 16 5/8	C C		A A	C	225249
29 1/4	16 1/4	3 11/16	CATERPILLAR	943 LOADER 8N184 HVY STEEL FINS 4 CRNRS OF CORE NOTCHED	Z	S	5	9	GR GR	6 1/2 6 1/2	16 5/8 16 5/8	C C		A A	C	225883
29 1/4	16 1/4	4 7/16	CATERPILLAR	953 LOADER 8N185 BRASS FINS 4 CRNRS OF CORE NOTCHED	Z	B	6	9	GR GR	6 1/2 6 1/2	16 5/8 16 5/8	C C		A A	C	225250
29 1/4	16 1/4	4 7/16	CATERPILLAR	953 LOADER 8N185 HVY STEEL FINS 4 CRNRS OF CORE NOTCHED	Z	S	6	9	GR GR	6 1/2 6 1/2	16 5/8 16 5/8	C C		A A	C	225891
29 1/4	16 1/2	4 1/2	CATERPILLAR	953 LOADER 8N185 BRASS FINS FACE DIPPED 4 CRNRS NOTCHED	B	B	6	7	GR GR	6 1/2 6 1/2	16 5/8 16 5/8	C C		A A	C	229503
29 5/16	29 3/8	4 7/16	CATERPILLAR	518 SKIDDER BRASS FINS	Z	B	6	9	GR GR	6 6	29 9/16 29 9/16	C C		A A	C	225355
29 5/16	29 3/8	5 3/16	CATERPILLAR	518 SKIDDER 8N4973 HVY STEEL FINS	Z	S	7	9	GR GR	6 6	29 9/16 29 9/16	C C		A A	C	225886
29 5/16	29 3/8	5 1/4	CATERPILLAR	518 SKIDDER	X	C	7	6	GR GR	6 6	29 9/16 29 9/16	C C		A A	C	266236
29 5/8	33 1/8	2 3/16	CATERPILLAR	14E GRADER 8S7794 2 BTM CRNRS NOTCHED	Z	C	3	9	BL BL	5 7/16 5 7/16	36 7/16 33 1/4	C C	34 30	F A	C	225253
29 5/8	33 1/8	2 15/16	CATERPILLAR	14E GRADER 8S7795 HVY T/BTM HDRS BRASS FINS 2 BTM CRNRS OF CORE NOTCHED	Z	B	4	9	BH BH	5 7/16 5 7/16	36 7/16 33 1/4	C C	34 30	F A	F	225189
29 5/8	33 1/8	2 15/16	CATERPILLAR	14E GRADER 8S7795 HVY T/BTM HDRS HVY STEEL FINS 2 BTM CRNRS OF CORE NOTCHED	Z	S	4	9	BH BH	5 7/16 5 7/16	36 7/16 33 1/4	C C	34 30	F A	F	225850
29 5/8	33 3/16	3	CATERPILLAR	14E GRADER HVY T/BTM HDRS 2 BTM CRNRS OF CORE NOTCHED	T	C	4	9	BH BH	5 7/16 5 7/16	36 7/16 33 1/4	C C	34 30	F A	C	277129
30	26 7/16	4 1/2	CATERPILLAR	955 HVY T/BTM HDRS BRASS FINS 4 CRNRS OF CORE NOTCHED	T	B	6	9	BH BH	6 1/2 6 1/2	26 3/4 26 3/4	C C	26 26	F F	C	260720
30	26 7/8	4 7/16	CATERPILLAR	955 3S9738 HVY T/BTM HDRS BRASS FINS 4 CRNRS OF CORE NOTCHED	Z	B	6	9	BH BH	6 1/2 6 1/2	26 3/4 26 3/4	C C	26 26	F F	F	225125

Vista-Pro Automotive - Core Catalog

(Cores Sorted by Application)

Height	Width	Depth	Application	Description	Fin Type	Fin Matl	Rows	FPI	BH/TH Type	BH/TH Width	BH/TH Length	BH/TH OHF	BH/TH Bolts	BH/TH Shape	Hdr Support	Part #
CATERPILLAR (Cont)																
30	26 7/8	4 7/16	CATERPILLAR	955 3S9738 HVY T/BTM HDRS HVY STEEL FINS 4 CRNRS OF CORE NOTCHED	Z	S	6	9	BH BH	6 1/2 6 1/2	26 3/4 26 3/4	C C	26 26	F F	F F	225836
30	30 5/8	4 7/16	CATERPILLAR	966 3S4515 HVY T/BTM HDRS BRASS FINS	Z	B	6	9	BH BH	6 5/8 6 5/8	36 1/4 31 1/4	C C	32 28	A A	C C	225023
30	35 7/16	4 1/2	CATERPILLAR	D-6 POWER SHIFT HVY T/BTM HDRS BRASS FINS 4 CRNRS OF CORE NOTCHED	T	B	6	9	BH BH	6 9/16 6 9/16	36 1/4 36 1/4	C C	32 32	F F	C C	263381
30	35 1/2	3	CATERPILLAR	D-6C HVY T/BTM HDRS BRASS FINS FACE DIPPED 4 CRNRS OF CORE NOTCHED	B	B	4	7	BH BH	6 9/16 6 9/16	36 1/4 36 1/4	C C	32 32	F F	C C	275214
30	35 1/2	4 1/2	CATERPILLAR	D-6C 9M6037 HVY T/BTM HDRS BRASS FINS FACE DIPPED 4 CRNRS OF CORE NOTCHED	B	B	6	7	BH BH	6 9/16 6 9/16	36 1/4 36 1/4	C C	32 32	F F	C C	229559
30	35 1/2	4 1/2	CATERPILLAR	D-6C 9M6037 HVY T/BTM HDRS BRASS FINS 4 CRNRS OF CORE NOTCHED	B	B	6	7	BH BH	6 9/16 6 9/16	36 1/4 36 1/4	C C	32 32	F F	C C	229591
30	35 5/8	2 15/16	CATERPILLAR	D-6C 7S1852 HVY T/BTM HDRS BRASS FINS 4 CRNRS OF CORE NOTCHED	Z	B	4	8	BH BH	6 9/16 6 9/16	36 1/4 36 1/4	C C	32 32	F F	C C	225048
30	35 5/8	3	CATERPILLAR	D-6C HVY T/BTM HDRS 4 CRNRS OF CORE NOTCHED	X	C	4	7	BH BH	6 9/16 6 9/16	36 1/4 36 1/4	C C	32 32	F F	C C	266160
30	35 5/8	4 7/16	CATERPILLAR	D-6C 9M6032 HVY T/BTM HDRS BRASS FINS 4 CRNRS OF CORE NOTCHED	Z	B	6	9	BH BH	6 9/16 6 9/16	36 1/4 36 1/4	C C	32 32	F F	C C	225061
30	35 5/8	4 7/16	CATERPILLAR	D-6C 7S2530 HVY T/BTM HDRS HVY STEEL FINS 4 CRNRS OF CORE NOTCHED	Z	S	6	9	BH BH	6 9/16 6 9/16	36 1/4 36 1/4	C C	32 32	F F	C C	225809
30 1/4	28 3/4	3 11/16	CATERPILLAR	916 LOADER 9Y8310	Z	C	5	9	GR GR	6 6	29 1/2 29 1/2	C C		A A	C C	225291
30 3/8	36 9/16	3	CATERPILLAR	D-7 BRASS FINS	T	B	4	7	GR GR	4 3/4 3 9/16	37 3/8 37 3/8	1/4 1/4		A A	CC	271936
30 1/2	24	4 1/2	CATERPILLAR	944D, 950 HVY T/BTM HDRS BRASS FINS FACE DIPPED	B	B	6	7	BH BH	6 1/2 6 1/2	27 3/4 24 7/16	C C	26 24	A A	C C	276855
30 1/2	24 3/16	4 1/2	CATERPILLAR	950 HVY T/BTM HDRS BRASS FINS TOP HDR OFFSET FOR O/C	T	B	6	9	BH BH	6 1/2 6 1/2	27 3/4 24 7/16	C C	26 24	A A	C C	264131
30 1/2	24 3/8	4 7/16	CATERPILLAR	950 3S2320 HVY T/BTM HDRS BRASS FINS 3 CRNRS OF CORE NOTCHED	Z	B	6	9	BH BH	6 1/2 6 1/2	27 3/4 24 3/8	C C	26 24	F F	C C	225358
30 1/2	24 3/8	4 7/16	CATERPILLAR	944D, 950 3S2320 HVY T/BTM HDRS HVY STEEL FINS	Z	S	6	7	BH BH	6 1/2 6 1/2	27 3/4 27 3/4	C C	26 26	F F	F F	225847
30 1/2	26 1/4	4 7/16	CATERPILLAR	966 7S2244 HVY T/BTM HDRS BRASS FINS	Z	B	6	7	BH BH	6 1/2 6 1/2	27 3/4 27 3/4	C C	26 26	F F	C C	225359
30 1/2	26 1/4	4 7/16	CATERPILLAR	966 7S2244 HVY T/BTM HDRS HVY STEEL FINS	Z	S	6	7	BH BH	6 1/2 6 1/2	27 3/4 27 3/4	C C	26 26	F F	C C	225888
30 1/2	26 7/16	4 1/2	CATERPILLAR	966 HVY T/BTM HDRS BRASS FINS	T	B	6	9	BH BH	6 1/2 6 1/2	27 3/4 27 3/4	C C	26 26	A A	C C	264064
30 1/2	26 1/2	4 1/2	CATERPILLAR	966 HVY T/BTM HDRS BRASS FINS FACE DIPPED	B	B	6	6	BH BH	6 1/2 6 1/2	27 3/4 27 3/4	C C	26 26	A A	C C	229560
30 1/2	26 1/2	4 1/2	CATERPILLAR	966 HVY T/BTM HDRS BRASS FINS	B	B	6	6	BH BH	6 1/2 6 1/2	27 3/4 27 3/4	C C	26 26	A A	C C	229593
30 9/16	33 1/8	3 11/16	CATERPILLAR	D342 HVY T/BTM HDRS	Z	C	5	10	BH BH	7 3/4 6 5/16	36 1/2 33 1/2	1 11/16 1	32 32	Q F	C C	225360
31 3/16	36	3	CATERPILLAR	D-7 HVY T/BTM HDRS BRASS FINS FACE DIPPED	B	B	4	7	BH BH	6 5/16 6 5/16	38 1/2 38 1/2	C C	34 34	F F	C C	274598

Vista-Pro Automotive - Core Catalog

(Cores Sorted by Application)

Height	Width	Depth	Application	Description	Fin Type	Fin Matl	Rows	FPI	BH / TH Type	BH / TH Width	BH / TH Length	BH / TH OHF	BH / TH Bolts	BH / TH Shape	Hdr Support	Part #
CATERPILLAR (Cont)																
31 11/16	28	3 3/4	CATERPILLAR	D-7 HVY T/BTM HDRS BRASS FINS	B	B	5	6	BH BH	6 3/8 6 3/8	29 7/8 29 7/8	C C	28 28	W W	C	229594
32	31 1/2	4 1/2	CATERPILLAR	D398 HVY T/BTM HDRS 4 CORES PER RAD	T	C	6	8	BH BH	7 3/8 7 3/8	33 3/4 33 3/4	C C	42 42	A A	C	272567
32	31 7/8	4 7/16	CATERPILLAR	D398 6L1533 HVY BTM HDR BRASS FINS 4 CORES PER RAD	Z	B	6	9	BL BH	7 3/8 7 3/8	33 3/4 33 3/4	C C	42 42	A A	C	225367
32	32 1/16	3 3/4	CATERPILLAR	HVY BTM HDR	T	C	5	9	BL BH	7 1/4 7 1/4	34 1/2 34 1/2	1 5/16 1 5/16	44 44	A A	C	272801
32	35 7/16	4 1/2	CATERPILLAR	D-6C HVY T/BTM HDRS BRASS FINS	T	B	6	9	BH BH	6 9/16 6 9/16	36 3/16 36 3/16	C C	32 32	A A	C	264006
32	35 1/2	4 1/2	CATERPILLAR	D-6C HVY T/BTM HDRS BRASS FINS FACE DIPPED	B	B	6	6	BH BH	6 9/16 6 9/16	36 3/16 36 3/16	C C	32 32	A A	C	229563
32	35 1/2	4 1/2	CATERPILLAR	D-6C HVY T/BTM HDRS BRASS FINS	B	B	6	6	BH BH	6 9/16 6 9/16	36 3/16 36 3/16	C C	32 32	A A	C	229595
32	35 5/8	4 7/16	CATERPILLAR	D-6 7S2385 HVY T/BTM HDRS BRASS FINS 4 CRNRS OF CORE NOTCHED	Z	B	6	8	BH BH	6 9/16 6 9/16	36 3/16 36 3/16	C C	32 32	A A	C	225051
32	35 5/8	4 7/16	CATERPILLAR	D-6 7S2385 HVY T/BTM HDRS HVY STEEL FINS 4 CRNRS OF CORE NOTCHED	Z	S	6	8	BH BH	6 9/16 6 9/16	36 3/16 36 3/16	C C	32 32	A A	C	225848
32 1/8	26 7/16	4 1/2	CATERPILLAR	D379 4 CORES PER RAD	T	C	6	8	BH BH	8 8	28 5/8 28 5/8	C C	36 36	A A	C	223110
32 1/8	26 7/8	3 11/16	CATERPILLAR	D379 4L648 4 CORES PER RAD	Z	C	5	9	BL BL	8 8	28 5/8 28 5/8	C C	36 36	A A	C	225295
32 1/8	26 7/8	4 7/16	CATERPILLAR	D379 5L2451 BRASS FINS 4 CORES PER RAD	Z	B	6	9	BL BL	8 8	28 5/8 28 5/8	C C	36 36	A A	C	225368
32 1/8	26 7/8	4 5/8	CATERPILLAR	D379 HVY T/BTM HDRS 4 CORES PER RAD	X	C	6	9	BH BH	8 8	28 5/8 28 5/8	C C	36 36	A A	C	266291
33	28 11/16	4 1/2	CATERPILLAR	3306 GEN SET	T	C	6	8	GR GR	7 1/2 5	29 5/8 29 5/8	1/4 1/4		A A	C	272568
33	28 3/4	4 7/16	CATERPILLAR	D337 BRASS FINS	Z	B	6	10	GR GR	7 1/2 5	29 5/8 29 5/8	1/4 1/4		A A	C	225372
33 1/4	28 11/16	3 3/4	CATERPILLAR	D333	T	C	5	9	GR GR	4 4	29 5/8 29 5/8	C C		A A	C	223069
33 1/4	28 11/16	4 1/2	CATERPILLAR	3306 GEN SET	T	C	6	8	GR GR	7 1/2 4 7/8	29 5/8 29 5/8	1/8 1/8		A A	C	272802
33 7/16	33 1/8	2 15/16	CATERPILLAR	140 GRADER 4Q5026	Z	C	4	9	GR GR	4 4	35 1/2 35 1/2	C C		A A	C	225299
33 7/16	21 1/4	4 7/16	CATERPILLAR	D-5 6N934 HVY T/BTM HDRS BRASS FINS 4 CRNRS OF CORE NOTCHED	Z	B	6	9	BH BH	6 9/16 6 9/16	22 3/4 22 3/4	C C	27 27	W W	C	225079
33 7/16	21 1/4	4 7/16	CATERPILLAR	D-5 6N542 HVY T/BTM HDRS HVY STEEL FINS 4 CRNRS OF CORE NOTCHED	Z	S	6	9	BH BH	6 9/16 6 9/16	22 3/4 22 3/4	C C	27 27	W F	F	225838
33 7/16	21 3/8	4 1/2	CATERPILLAR	D-5 HVY T/BTM HDRS BRASS FINS	T	B	6	9	BH BH	6 9/16 6 9/16	22 3/4 22 3/4	C C	27 27	W W	F	265489
33 7/16	21 1/2	4 1/2	CATERPILLAR	D-5 HVY T/BTM HDRS BRASS FINS FACE DIPPED 4 CRNRS OF CORE NOTCHED	B	B	6	6	BH BH	6 9/16 6 9/16	22 3/4 22 3/4	C C	27 27	W W	C	277350
33 7/16	27 1/2	2 3/16	CATERPILLAR	D-5 6N541, 7N4987 HVY T/BTM HDRS 4 CRNRS OF CORE NOTCHED	Z	C	3	7	BH BH	6 9/16 6 9/16	29 3/8 29 3/8	C C	34 34	A A	C	225223
33 7/16	27 1/2	3 11/16	CATERPILLAR	D-5 6N543, 8N8842 HVY T/BTM HDRS HVY STEEL FINS 4 CRNRS OF CORE NOTCHED	Z	S	5	8	BH BH	6 9/16 6 9/16	29 3/8 29 3/8	C C	34 34	A F	C	225893

Vista-Pro Automotive - Core Catalog

(Cores Sorted by Application)

Height	Width	Depth	Application	Description	Fin Type	Fin Matl	Rows	FPI	BH / TH Type	BH / TH Width	BH / TH Length	BH / TH OHF	BH / TH Bolts	BH / TH Shape	Hdr Support	Part #	
CATERPILLAR (Cont)																	
33	7/16	27 1/2	3 3/4	CATERPILLAR	D-5 HVY T/BTM HDRS BRASS FINS FACE DIPPED	B	B	5	7	BH BH	6 9/16 6 9/16	29 3/8 29 3/8	C C	34 34	A A	C	272612
33	7/16	33 1/8	2 3/16	CATERPILLAR	140 GRADER 8N73	Z	C	3	9	GR GR	4 4	35 1/2 35 1/2	C C		A A	C	225298
33	7/16	33 1/8	2 3/16	CATERPILLAR	140 GRADER 8N73 HVY STEEL FINS	Z	S	3	9	GR GR	4 4	35 1/2 35 1/2	C C		A A	C	225896
33	7/16	33 1/8	2 15/16	CATERPILLAR	140 GRADER 4Q5026 HVY STEEL FINS	Z	S	4	9	GR GR	4 4	35 1/2 35 1/2	C C		0 0	C	225895
33	7/16	33 1/8	3 11/16	CATERPILLAR	140G GRADER 7W2949 BRASS FINS	Z	B	5	8	GR GR	4 4	35 1/2 35 1/2	C C		A A	C	225379
33	7/16	33 1/2	3	CATERPILLAR	245 EXCAVATOR	B	C	4	7	GR GR	4 4	35 1/2 35 1/2	C C		A A	C	229504
33	7/16	33 1/2	3 3/4	CATERPILLAR	14G GRADER	B	C	5	8	GR GR	4 4	35 1/2 35 1/2	C C		A A	C	272803
33	1/2	33 3/16	5 1/4	CATERPILLAR	16G GRADER HVY T/BTM HDRS BRASS FINS	T	B	7	8	BH BH	8 8	40 35 1/4	C C	38 34	F F	C	265178
33	1/2	39 3/8	3	CATERPILLAR	D13000 HVY BTM HDR	T	C	4	7	BL BH	6 1/8 6 1/8	43 43	C C	36 36	H H	C	271350
33	5/8	33 1/8	2 15/16	CATERPILLAR	245 EXCAVATOR 7N7330	Z	C	4	9	GR GR	4 4	35 1/2 35 1/2	C C		A A	C	225047
33	5/8	33 1/8	3 11/16	CATERPILLAR	245 EXCAVATOR 2P9586	Z	C	5	9	GR GR	4 4	35 1/2 35 1/2	C C		A A	C	225073
33	5/8	33 3/16	3 3/4	CATERPILLAR	245 EXCAVATOR HVY STEEL FINS	T	S	5	9	GR GR	4 4	35 1/2 35 1/2	C C		A A	C	265651
33	3/4	27 1/2	2 1/4	CATERPILLAR	D-5 HVY T/BTM HDRS BRASS FINS FACE DIPPED	B	B	3	7	BH BH	5 3/4 5 3/4	29 3/8 29 3/8	C C	28 28	F F	C	278825
33	3/4	27 1/2	2 15/16	CATERPILLAR	D-5 HVY T/BTM HDRS BRASS FINS 4 CRNRS OF CORE NOTCHED	Z	B	4	9	BH BH	5 3/4 5 3/4	29 3/8 29 3/8	C C	28 28	F F	C	225107
33	3/4	27 1/2	3 11/16	CATERPILLAR	D-5 5S8450 HVY T/BTM HDRS BRASS FINS 4 CRNRS OF CORE NOTCHED	Z	B	5	8	BH BH	5 3/4 5 3/4	29 3/8 29 3/8	C C	28 28	F F	C	225611
33	3/4	27 1/2	3 11/16	CATERPILLAR	D-5 5S8450 HVY T/BTM HDRS HVY STEEL FINS 4 CRNRS OF CORE NOTCHED	Z	S	5	8	BH BH	5 3/4 5 3/4	29 3/8 29 3/8	C C	28 28	F F	C	225839
33	3/4	27 1/2	3 3/4	CATERPILLAR	D-5 HVY T/BTM HDRS BRASS FINS 4 CRNRS OF CORE NOTCHED	B	B	5	6	BH BH	5 3/4 5 3/4	29 3/8 29 3/8	C C	28 28	F F	C	229596
34		33	4 1/2	CATERPILLAR	235 EXCAVATOR HVY T/BTM HDRS BRASS FINS FACE DIPPED	B	B	6	7	BH BH	8 3/8 8 3/8	36 36	C C	36 36	A A	C	272570
34		33	5 1/4	CATERPILLAR	235 EXCAVATOR HVY T/BTM HDRS BRASS FINS FACE DIPPED	B	B	7	7	BH BH	8 3/8 8 3/8	36 36	C C	36 36	A A	C	272571
34		33 1/8	5 3/16	CATERPILLAR	235 EXCAVATOR 7W8891 HVY T/BTM HDRS BRASS FINS	Z	B	7	10	BH BH	8 3/8 8 3/8	36 36	C C	36 36	A A	C	225141
34		33 1/8	5 3/16	CATERPILLAR	235 EXCAVATOR 2P5218 HVY T/BTM HDRS HVY STEEL FINS	Z	S	7	10	BH BH	8 3/8 8 3/8	36 36	C C	36 36	A A	C	225841
34		33 3/16	5 1/4	CATERPILLAR	235 EXCAVATOR HVY T/BTM HDRS BRASS FINS	T	B	7	9	BH BH	8 3/8 8 3/8	36 36	C C	36 36	A A	C	265670
34	9/16	34 1/2	3 3/4	CATERPILLAR	D-8 HVY T/BTM HDRS BRASS FINS	B	B	5	6	BH BH	6 5/16 6 5/16	36 36	C C	32 32	W W	C	229597
34	3/4	26 7/16	4 1/2	CATERPILLAR	D-6C HVY T/BTM HDRS BRASS FINS 4 CRNRS OF CORE NOTCHED	T	B	6	9	BH BH	6 9/16 6 9/16	28 28	C C	30 30	F W	C	223111

Vista-Pro Automotive - Core Catalog

(Cores Sorted by Application)

Height	Width	Depth	Application	Description	Fin Type	Fin Matl	Rows	FPI	BH/TH Type	BH/TH Width	BH/TH Length	BH/TH OHF	BH/TH Bolts	BH/TH Shape	Hdr Support	Part #
CATERPILLAR (Cont)																
34 3/4	26 1/2	4 1/2	CATERPILLAR	D-6C HVY T/BTM HDRS BRASS FINS FACE DIPPED 4 CRNRS OF CORE NOTCHED	B	B	6	6	BH BH	6 5/8 6 5/8	28 28	C C	30 30	A A	C	229537
34 3/4	26 1/2	4 1/2	CATERPILLAR	D-6C HVY T/BTM HDRS BRASS FINS 4 CRNRS OF CORE NOTCHED	B	B	6	6	BH BH	6 9/16 6 9/16	28 28	C C	30 30	A W	C	229599
34 3/4	26 7/8	4 7/16	CATERPILLAR	D-6C 4N6298 HVY T/BTM HDRS BRASS FINS 4 CRNRS OF CORE NOTCHED	Z	B	6	9	BH BH	6 9/16 6 9/16	28 28	C C	30 30	F W	C	225081
34 3/4	31 1/4	4 7/16	CATERPILLAR	D-6C 7N4384 HVY T/BTM HDRS BRASS FINS 4 CRNRS OF CORE NOTCHED	Z	B	6	9	BH BH	6 9/16 6 9/16	33 1/8 33 1/8	C C	36 36	F A	C	225194
34 3/4	31 1/4	4 7/16	CATERPILLAR	D-6C 7N4384 HVY T/BTM HDRS HVY STEEL FINS 4 CRNRS OF CORE NOTCHED	Z	S	6	9	BH BH	6 9/16 6 9/16	33 1/8 33 1/8	C C	36 36	F A	C	225874
34 3/4	31 1/2	3	CATERPILLAR	D-6C HVY T/BTM HDRS BRASS FINS 4 CRNRS OF CORE NOTCHED	B	B	4	7	BH BH	6 9/16 6 9/16	33 1/8 33 1/8	C C	36 36	F F	C	229598
34 3/4	31 1/2	4 1/2	CATERPILLAR	D-6D HVY T/BTM HDRS BRASS FINS FACE DIPPED 4 CRNRS OF CORE NOTCHED	B	B	6	7	BH BH	6 5/8 6 5/8	33 1/16 33 1/16	C C	36 36	A F	C	229505
35 3/4	22 1/2	4 7/16	CATERPILLAR	955K, 955L HVY T/BTM HDRS BRASS FINS	Z	B	6	9	BH BH	7 3/8 7 3/8	24 1/8 24 1/8	C C	26 26	F F	C	225152
35 3/4	22 1/2	5 3/16	CATERPILLAR	955K, 955L 2P1332-HVY T/BTM HDRS BRASS FINS	Z	B	7	9	BH BH	7 3/8 7 3/8	24 1/8 24 1/8	C C	26 26	F F	C	225137
35 3/4	22 1/2	5 3/16	CATERPILLAR	955K, 955L 2P1332-HVY T/BTM HDRS HVY STEEL FINS	Z	S	7	9	BH BH	7 3/8 7 3/8	24 1/8 24 1/8	C C	26 26	F F	C	225875
35 3/4	23	5 1/4	CATERPILLAR	955L HVY T/BTM HDRS BRASS FINS FACE DIPPED	B	B	7	6	BH BH	7 3/8 7 3/8	24 1/8 24 1/8	C C	26 26	F F	C	229506
35 15/16	36	4 1/2	CATERPILLAR	D342 HVY T/BTM HDRS	T	C	6	8	BH BH	8 8	39 1/2 39 1/2	C C	50 50	A A	C	272604
35 15/16	36	4 1/2	CATERPILLAR	D343, D353 HVY T/BTM HDRS BRASS FINS FACE DIPPED	B	B	6	7	BH BH	8 8	39 1/2 39 1/2	C C	50 50	A A	C	274988
35 15/16	36 1/4	3 3/4	CATERPILLAR	D343, D353 HVY T/BTM HDRS	X	C	5	9	BH BH	8 8	39 1/2 39 1/2	C C	50 50	A A	C	266162
35 15/16	36 1/4	4 7/16	CATERPILLAR	D353 3L5102 HVY BTM HDR BRASS FINS	Z	B	6	9	BL BH	8 8	39 1/2 39 1/2	C C	50 50	A A	C	225382
36 13/16	39 15/16	4 1/2	CATERPILLAR	D-7 HVY T/BTM HDRS BRASS FINS 4 CRNRS OF CORE NOTCHED	T	B	6	8	BH BH	6 9/16 6 9/16	41 1/2 41 1/2	C C	38 38	E E	C	263211
36 13/16	40	4 7/16	CATERPILLAR	D-7 9M9775 HVY T/BTM HDRS BRASS FINS 4 CRNRS OF CORE NOTCHED	Z	B	6	8	BH BH	6 9/16 6 9/16	41 1/2 41 1/2	C C	38 38	E E	F	225383
36 13/16	40	4 1/2	CATERPILLAR	D-7 HVY T/BTM HDRS BRASS FINS FACE DIPPED 4 CRNRS OF CORE NOTCHED	B	B	6	6	BH BH	6 9/16 6 9/16	41 1/2 41 1/2	C C	38 38	E E	C	274942
37 1/2	37 1/2	4 7/16	CATERPILLAR	627, 637 SCRAPER 2P6830 HVY T/BTM HDRS BRASS FINS	Z	B	6	9	BH BH	8 8	40 40	1 1/8 1 1/8	38 38	A A	F	225175
37 1/2	37 1/2	4 7/16	CATERPILLAR	627, 637 SCRAPER 9S3767 HVY T/BTM HDRS HVY STEEL FINS	Z	S	6	9	BH BH	8 8	40 40	1 1/8 1 1/8	38 38	A A	F	225833
37 1/2	37 1/2	4 1/2	CATERPILLAR	D-8 HVY T/BTM HDRS BRASS FINS FACE DIPPED	B	B	6	6	BH BH	8 8	40 40	C C	38 38	A A	C	277353
37 1/2	37 11/16	4 1/2	CATERPILLAR	627, 637 SCRAPER HVY T/BTM HDRS HVY STEEL FINS	T	S	6	9	BH BH	8 8	40 40	C C	38 38	A A	C	265551

Vista-Pro Automotive - Core Catalog

(Cores Sorted by Application)

Height	Width	Depth	Application	Description	Fin Type	Fin Matl	Rows	FPI	BH / TH Type	BH / TH Width	BH / TH Length	BH / TH OHF	BH / TH Bolts	BH / TH Shape	Hdr Support	Part #	
CATERPILLAR (Cont)																	
37	9/16	43	4 1/2	CATERPILLAR	D-8 HVY T/BTM HDRS BRASS FINS	B	B	6	6	BH BH	6 3/8 45 1/2	45 1/2	C	40	F	CC	229649
37	9/16	43 1/8	4 7/16	CATERPILLAR	D-8 3S6223 HVY T/BTM HDRS SGL CTR MTG BAR BRASS FINS 4 CRNRS NOTCHED	Z	B	6	9	BH	6 3/8	45 1/2	C	40	F	F	225147
37	9/16	43 5/16	3 3/4	CATERPILLAR	D-8 HVY T/BTM HDRS BRASS FINS SGL CTR MTG BAR	T	B	5	7	BH BH	6 3/8 45 1/2	45 1/2	1	40	F	F	265029
37	9/16	43 5/16	4 1/2	CATERPILLAR	D-8 HVY T/BTM HDRS BRASS FINS RVS CTR MTG BAR	T	B	6	7	BH BH	6 3/8 45 1/2	45 1/2	C	40	F	F	223247
37	9/16	43 5/16	4 1/2	CATERPILLAR	D-8 HVY T/BTM HDRS BRASS FINS	T	B	6	8	BH BH	6 3/8 45 1/2	45 1/2	C	40	F	CC	223261
37	5/8	38 1/2	4 1/2	CATERPILLAR	D398 HVY T/BTM HDRS	B	C	6	7	BH BH	7 1/2 41 1/4	41 1/4	C	50	A	CC	277354
37	3/4	27 1/2	4 7/16	CATERPILLAR	955K 5S5991 HVY T/BTM HDRS BRASS FINS 4 CRNRS OF CORE NOTCHED	Z	B	6	9	BH BH	7 5/16 29 3/8	29 3/8	C	34	F	F	225123
37	3/4	27 9/16	4 1/2	CATERPILLAR	955 HVY T/BTM HDRS BRASS FINS 4 CRNRS OF CORE NOTCHED	T	B	6	9	BH BH	7 5/16 29 3/8	29 3/8	C	34	F	C	264353
37	3/4	28	4 1/2	CATERPILLAR	955 HVY T/BTM HDRS BRASS FINS FACE DIPPED 4 CRNRS OF CORE NOTCHED	B	B	6	7	BH BH	7 5/16 29 3/8	29 3/8	C	34	F	C	229539
38	31 1/2	3 3/4	4 1/2	CATERPILLAR	966 LOADER HVY T/BTM HDRS BRASS FINS FACE DIPPED 4 CRNRS OF CORE NOTCHED	B	B	5	7	BH	8 1/4	32 13/16	C	32	A	C	229507
38	31 1/2	4 1/2	4 1/2	CATERPILLAR	966 LOADER HVY T/BTM HDRS BRASS FINS 4 CRNRS OF CORE NOTCHED	T	B	6	9	BH BH	8 1/4 32 13/16	32 13/16	C	32	A	C	265022
38	31 7/8	3 11/16	4 1/2	CATERPILLAR	966C 1P4404 HVY T/BTM HDRS 4 CRNRS OF CORE NOTCHED	Z	C	5	9	BH BH	8 1/4 32 13/16	32 13/16	C	32	A	C	225113
38	31 7/8	3 11/16	4 1/2	CATERPILLAR	966C 1P4404 HVY T/BTM HDRS HVY STEEL FINS 4 CRNRS OF CORE NOTCHED	Z	S	5	9	BH BH	8 1/4 32 13/16	32 13/16	C	32	A	C	225909
38	31 7/8	4 7/16	4 1/2	CATERPILLAR	966 9S4104 HVY T/BTM HDRS BRASS FINS 4 CRNRS OF CORE NOTCHED	Z	B	6	9	BH BH	8 1/4 32 13/16	32 13/16	C	32	A	C	225055
38	31 7/8	4 7/16	4 1/2	CATERPILLAR	966 9S4104 HVY T/BTM HDRS HVY STEEL FINS 4 CRNRS OF CORE NOTCHED	Z	S	6	9	BH BH	8 1/4 32 13/16	32 13/16	C	32	A	C	225863
38	31 7/8	5 3/16	4 1/2	CATERPILLAR	814, 815, 816 2P6111 HVY T/BTM HDRS BRASS FINS 4 CRNRS OF CORE NOTCHED	Z	B	7	9	BH BH	8 1/4 32 13/16	32 13/16	C	32	A	F	225219
38	32	4 1/2	4 1/2	CATERPILLAR	966C HVY T/BTM HDRS BRASS FINS	B	B	6	7	BH BH	8 1/4 32 13/16	32 13/16	C	32	A	C	229542
38	33 1/8	4 7/16	4 1/2	CATERPILLAR	977 3S9737 HVY T/BTM HDRS HVY STEEL FINS 4 CRNRS OF CORE NOTCHED	Z	S	6	9	BH BH	6 1/2 33 1/4	33 1/4	C	30	A	F	225843
38	34 3/8	4 7/16	4 1/2	CATERPILLAR	HVY T/BTM HDRS BRASS FINS 4 CORES PER RAD	Z	B	6	11	BH BH	8 37 1/4	37 1/4	C	44	A	C	225389
38	36	3 3/4	4 1/2	CATERPILLAR	3406 HVY T/BTM HDRS BRASS FINS	T	B	5	8	BH BH	10 1/2 39 1/2	39 1/2	1 3/4	52	A	C	223070
38	36	5 1/4	4 1/2	CATERPILLAR	3408 HVY T/BTM HDRS	T	C	7	8	BH BH	10 1/2 39 1/2	39 1/2	1 3/4	52	A	C	272577
38	36 1/4	3 11/16	4 1/2	CATERPILLAR	3412 ENGINE 4N8191 HVY T/BTM HDRS	Z	C	5	9	BH BH	10 1/2 39 1/2	39 1/2	1 3/4	52	A	C	225549

Vista-Pro Automotive - Core Catalog

(Cores Sorted by Application)

Height	Width	Depth	Application	Description	Fin Type	Fin Matl	Rows	FPI	BH/TH Type	BH/TH Width	BH/TH Length	BH/TH OHF	BH/TH Bolts	BH/TH Shape	Hdr Support	Part #
CATERPILLAR (Cont)																
38	36 1/4	4 7/16	CATERPILLAR	8N4878 HVY BTM HDR BRASS FINS	Z	B	6	9	BH BH	10 1/2 8	39 1/2 39 1/2	1 3/4 1 3/4	52 50	A A	C	225386
38	36 1/4	5 3/16	CATERPILLAR	HVY BTM HDR BRASS FINS	Z	B	7	8	BH BH	10 1/2 8	39 1/2 39 1/2	1 3/4 1 3/4	52 50	A A	C	225395
38	36 9/16	4 1/2	CATERPILLAR	HVY T/BTM HDRS BRASS FINS	T	B	6	10	BH BH	10 1/2 8	39 1/2 39 1/2	1 3/4 1 3/4	52 50	A A	C	265858
38	37 1/2	3 15/16	CATERPILLAR	D398 8L5765 HVY T/BTM HDRS 4 CORES PER RAD	S	C	7	10	BH BH	7 3/8 7 3/8	40 40	C C	48 48	A A	C	229200
38	37 1/2	4 7/16	CATERPILLAR	D398 6L2344 HVY T/BTM HDRS BRASS FINS 4 CORES PER RAD	Z	B	6	9	BH BH	7 3/8 7 3/8	40 40	C C	48 48	A A	C	225390
38	38	4 1/2	CATERPILLAR	D398 HVY T/BTM HDRS BRASS FINS FACE DIPPED	B	B	6	6	BH BH	7 3/8 7 3/8	40 40	C C	48 48	A A	F	229508
38	38 1/4	4 1/2	CATERPILLAR	D398 HVY T/BTM HDRS BRASS FINS	T	B	6	9	BH BH	7 3/8 7 3/8	40 40	C C	48 48	A A	C	223112
38	38 1/4	4 1/2	CATERPILLAR	D399 STATIONARY ENGINE HVY T/BTM HDRS BRASS FINS	T	B	6	9	BH BH	7 1/4 7 1/4	40 1/4 40 1/4	C C	50 50	A A	C	265669
38 5/16	30	4 7/16	CATERPILLAR	1W1895 HVY T/BTM HDRS BRASS FINS	Z	B	6	9	BH BH	9 9	33 1/2 33 1/2	C C	40 40	A A	C	225078
38 5/16	30	4 1/2	CATERPILLAR	950 HVY T/BTM HDRS BRASS FINS FACE DIPPED	B	B	6	7	BH BH	9 9	33 1/2 33 1/2	C C	40 40	A A	C	272792
38 7/8	34 7/8	4 1/2	CATERPILLAR	D398 HVY T/BTM HDRS 4 CORES PER RAD	T	C	6	8	BH BH	7 1/2 7 1/2	37 1/4 37 1/4	C C	48 48	A A	C	223113
39	29 13/16	6	CATERPILLAR	621 HVY T/BTM HDRS BRASS FINS	T	B	8	9	BH BH	8 8	32 32	C C	34 34	F F	C	264386
39	30	6	CATERPILLAR	621 5S602 HVY T/BTM HDRS BRASS FINS	Z	B	8	8	BH BH	8 8	32 32	C C	34 34	F F	F	225044
39	45	5 3/16	CATERPILLAR	769B 2P1234 HVY T/BTM HDRS BRASS FINS	Z	B	7	9	BH BH	8 8	47 7/16 47 7/16	C C	46 46	F F	CC	225080
39	45	5 3/16	CATERPILLAR	769B 2P1234 HVY T/BTM HDRS HVY STEEL FINS	Z	S	7	9	BH BH	8 8	47 7/16 47 7/16	C C	46 46	F F	F	225823
39	59 5/8	4 1/2	CATERPILLAR	HVY T/BTM HDRS	T	C	6	8	BH BH	7 1/2 7 1/2	61 3/4 61 3/4	C C	72 72	A A	CC	272793
39 1/16	37 1/2	6	CATERPILLAR	631B SCRAPER 1S250 HVY T/BTM HDRS BRASS FINS	Z	B	8	8	BH BH	8 8	40 40	C C	38 38	F F	C	225068
39 1/16	38	6	CATERPILLAR	631 HVY T/BTM HDRS BRASS FINS FACE DIPPED	B	B	8	7	BH BH	8 8	40 40	C C	38 38	F F	C	275439
39 7/16	22 1/2	6	CATERPILLAR	980B 7N4995 HVY T/BTM HDRS BRASS FINS 4 CRNRS OF CORE NOTCHED	Z	B	8	9	BH BH	8 8	23 1/8 23 1/8	C C	24 24	F F	C	225082
39 7/16	22 1/2	6	CATERPILLAR	980B 9S5149 HVY T/BTM HDRS HVY STEEL FINS 4 CRNRS OF CORE NOTCHED	Z	S	8	9	BH BH	8 8	23 1/8 23 1/8	C C	24 24	F F	F	225812
39 7/16	22 1/2	6	CATERPILLAR	980B LOADER HVY T/BTM HDRS BRASS FINS FACE DIPPED	B	B	8	7	BH BH	8 8	23 23	C C	24 24	A A	C	277135
40	36	4 1/2	CATERPILLAR	D339 HVY T/BTM HDRS BRASS FINS	T	B	6	8	BH BH	7 1/2 7 1/2	40 40	C C	46 46	A A	C	272799
40	37 1/2	4 7/16	CATERPILLAR	637 SCRAPER 7N1580 HVY T/BTM HDRS BRASS FINS	Z	B	6	9	BH BH	8 8	40 40	C C	38 38	A A	C	225538
40	37 1/2	6	CATERPILLAR	637 SCRAPER 4N7295 HVY T/BTM HDRS BRASS FINS	Z	B	8	9	BH BH	8 8	40 40	C C	38 38	A A	C	225182

Vista-Pro Automotive - Core Catalog

(Cores Sorted by Application)

Height	Width	Depth	Application	Description	Fin Type	Fin Matl	Rows	FPI	BH / TH Type	BH / TH Width	BH / TH Length	BH / TH OHF	BH / TH Bolts	BH / TH Shape	Hdr Support	Part #
CATERPILLAR (Cont)																
40	37 1/2	6	CATERPILLAR	637 SCRAPER 4N7295 HVY T/BTM HDRS BRASS FINS FACE DIPPED	B	B	8	6	BH BH	8 8	40 40	C C	38 38	A A	C	278837
40	41 7/8	4 7/16	CATERPILLAR	BRASS FINS 4 CORES PER RAD	Z	B	6	9	BL BL	7 1/2 7 1/2	45 1/2 45 1/2	C C	52 52	A A	CC	225399
40 3/8	25 1/2	6	CATERPILLAR	977L HVY T/BTM HDRS BRASS FINS FACE DIPPED 4 CRNRS OF CORE NOTCHED	B	B	8	7	BH BH	8 1/4 8 1/4	28 1/8 26 7/8	C C	28 26	F F	C	229564
40 3/8	25 1/2	6	CATERPILLAR	977L HVY T/BTM HDRS BRASS FINS 4 CRNRS OF CORE NOTCHED	B	B	8	7	BH BH	8 1/4 8 1/4	28 1/8 26 7/8	C C	28 26	F F	C	229610
40 3/8	25 5/8	6	CATERPILLAR	977L 1P1683 HVY T/BTM HDRS BRASS FINS 4 CRNRS OF CORE NOTCHED	Z	B	8	9	BH BH	8 1/4 8 1/4	28 1/8 26 7/8	C C	28 26	F F	F	225124
40 3/8	25 5/8	6	CATERPILLAR	977L 1P1683 HVY T/BTM HDRS HVY STEEL FINS 4 CRNRS OF CORE NOTCHED	Z	S	8	9	BH BH	8 1/4 8 1/4	28 1/8 26 7/8	C C	28 26	F F	F	225832
40 3/8	25 7/8	6	CATERPILLAR	977L HVY T/BTM HDRS BRASS FINS 4 CRNRS OF CORE NOTCHED	T	B	8	9	BH BH	8 1/4 8 1/4	28 1/8 26 7/8	C C	28 26	F F	C	265024
40 7/16	30 5/8	6	CATERPILLAR	977K 5S7261 HVY T/BTM HDRS BRASS FINS 4 CRNRS OF CORE NOTCHED	Z	B	8	8	BH BH	8 1/4 8	35 1/2 32 1/4	C C	36 32	F F	F	225045
40 7/16	30 15/16	6	CATERPILLAR	977K HVY T/BTM HDRS BRASS FINS 4 CRNRS OF CORE NOTCHED	T	B	8	9	BH BH	8 1/4 8	35 1/2 32 1/4	C C	36 32	A A	C	264065
40 7/16	31	6	CATERPILLAR	977K HVY T/BTM HDRS BRASS FINS FACE DIPPED 4 CRNRS OF CORE NOTCHED	B	B	8	7	BH BH	8 1/4 8	35 1/2 32 1/4	C C	36 32	A A	C	229544
40 7/16	31	6	CATERPILLAR	977K HVY T/BTM HDRS BRASS FINS 4 CRNRS OF CORE NOTCHED	B	B	8	7	BH BH	8 1/4 8	35 1/2 32 1/4	C C	36 32	A A	C	229611
41	37 1/2	6	CATERPILLAR	637 SCRAPER 8S4199 HVY T/BTM HDRS BRASS FINS	Z	B	8	9	BH BH	8 8	40 40	C C	38 38	A A	C	225086
41	37 1/2	6	CATERPILLAR	637 SCRAPER HVY T/BTM HDRS BRASS FINS FACE DIPPED	B	B	8	7	BH BH	8 8	40 40	C C	38 38	A A	C	272580
41 1/2	31 1/2	3 3/4	CATERPILLAR	D398 HVY T/BTM HDRS 4 CORES PER RAD	T	C	5	8	BH BH	7 1/2 7 1/2	34 34	C C	42 42	A A	C	272581
41 1/2	31 1/2	4 1/2	CATERPILLAR	D398 HVY T/BTM HDRS 4 CORES PER RAD	T	C	6	8	BH BH	7 1/2 7 1/2	34 34	C C	40 40	A A	C	272808
41 9/16	21 1/4	3 11/16	CATERPILLAR	963 TRACK LOADER 1W1502 HVY T/BTM HDRS BRASS FINS	Z	B	5	9	BH BH	9 13/16 9 13/16	23 5/16 23 5/16	C C	30 30	F F	F	225204
41 9/16	21 1/4	3 11/16	CATERPILLAR	963 TRACK LOADER 1W1502 HVY T/BTM HDRS HVY STEEL FINS	Z	S	5	9	BH BH	9 13/16 9 13/16	23 5/16 23 5/16	C C	30 30	F F	F	225814
41 9/16	21 3/8	3 3/4	CATERPILLAR	963 TRACK LOADER HVY T/BTM HDRS HVY STEEL FINS	T	S	5	9	BH BH	9 13/16 9 13/16	23 5/16 23 5/16	C C	30 30	F F	C	266460
42	39 3/8	2 3/16	CATERPILLAR	16 GRADER 7N3457 HVY T/BTM HDRS HVY STEEL FINS CTR SUPPORT FINS	Z	S	3	9	BH BH	8 7/8 8 7/8	42 3/8 42 3/8	C C	44 44	A A	C	225912
42	39 3/8	2 1/4	CATERPILLAR	16G GRADER HVY T/BTM HDRS HVY STEEL FINS	T	S	3	9	BH BH	8 7/8 8 7/8	42 3/8 42 3/8	C C	44 44	A A	C	266469
42	39 3/8	3	CATERPILLAR	16 GRADER HVY T/BTM HDRS	T	C	4	8	BH BH	8 7/8 8 7/8	42 3/8 42 3/8	C C	44 44	A A	C	272807
42	39 15/16	4 1/2	CATERPILLAR	621B, 623B HVY T/BTM HDRS HVY STEEL FINS	T	S	6	10	BH BH	8 7/8 8 7/8	42 3/8 42 3/8	3 3	44 44	A A	C	265605

Vista-Pro Automotive - Core Catalog

(Cores Sorted by Application)

Height	Width	Depth	Application	Description	Fin Type	Fin Matl	Rows	FPI	BH / TH Type	BH / TH Width	BH / TH Length	BH / TH OHF	BH / TH Bolts	BH / TH Shape	Hdr Support	Part #
CATERPILLAR (Cont)																
42	40	2 15/16	CATERPILLAR	7N1478 HVY T/BTM HDRS	Z	C	4	9	BH BH	8 7/8 8 7/8	42 3/8 42 3/8	2 1/4 2 1/4	44 44	A A	C	225094
42	40	3 3/4	CATERPILLAR	623B HVY T/BTM HDRS BRASS FINS FACE DIPPED	B	B	5	7	BH BH	8 7/8 8 7/8	42 3/8 42 3/8	C C	44 44	A A	C	272795
42	40	4 7/16	CATERPILLAR	627B 4N9374 HVY T/BTM HDRS BRASS FINS	Z	B	6	9	BH BH	8 7/8 8 7/8	42 3/8 42 3/8	1 7/16 1 7/16	44 44	A A	F	225074
42	40	5 3/16	CATERPILLAR	621B, 623B 4N4342 HVY T/BTM HDRS BRASS FINS	Z	B	7	9	BH BH	8 7/8 8 7/8	42 3/8 42 3/8	C C	44 44	A A	F	225171
42	40	5 3/16	CATERPILLAR	621B, 623B 4N4342 HVY T/BTM HDRS HVY STEEL FINS	Z	S	7	9	BH BH	8 7/8 8 7/8	42 3/8 42 3/8	C C	44 44	A A	F	225831
42	40	5 1/4	CATERPILLAR	621B, 623B 4N4342 HVY T/BTM HDRS	B	C	7	6	BH BH	8 7/8 8 7/8	42 3/8 42 3/8	1 5/8 1 5/8	44 44	A A	C	278839
42 1/8	40	3 11/16	CATERPILLAR	621B, 623B 8N5980 HVY T/BTM HDRS CTR SUPPORT FINS	Z	C	5	9	BH BH	8 7/8 8 7/8	42 3/8 42 3/8	C C	44 44	A A	C	225088
42 1/8	40	3 11/16	CATERPILLAR	621B, 623B 8N5980 HVY T/BTM HDRS HVY STEEL FINS CTR SUPPORT FINS	Z	S	5	9	BH BH	8 7/8 8 7/8	42 3/8 42 3/8	C C	44 44	A A	C	225905
42 1/8	40	5 3/16	CATERPILLAR	621B, 623B 8N5979 HVY T/BTM HDRS BRASS FINS CTR SUPPORT FINS	Z	B	7	9	BH BH	8 7/8 8 7/8	42 3/8 42 3/8	C C	44 44	A A	C	225114
42 1/8	40	5 3/16	CATERPILLAR	621B, 623B 8N5979 HVY T/BTM HDRS HVY STEEL FINS CTR SUPPORT FINS	Z	S	7	9	BH BH	8 7/8 8 7/8	42 3/8 42 3/8	C C	44 44	A A	F	225907
42 13/16	34 3/8	3 11/16	CATERPILLAR	966D 8N1692 HVY T/BTM HDRS BRASS FINS	Z	B	5	9	BH BH	9 9	37 9/16 37 9/16	C C	42 42	F F	F	225184
42 13/16	34 3/8	3 11/16	CATERPILLAR	966D 8N1692 HVY T/BTM HDRS HVY STEEL FINS	Z	S	5	9	BH BH	9 9	37 9/16 37 9/16	C C	42 42	F F	F	225844
42 13/16	34 1/2	3 3/4	CATERPILLAR	966D HVY T/BTM HDRS BRASS FINS FACE DIPPED	B	B	5	7	BH BH	9 9	37 9/16 37 9/16	C C	42 42	F F	C	272582
42 13/16	34 1/2	3 3/4	CATERPILLAR	966D HVY T/BTM HDRS	B	C	5	7	BH BH	9 9	37 9/16 37 9/16	C C	42 42	F F	C	272809
42 13/16	34 7/8	3 3/4	CATERPILLAR	966D WHEEL LOADER HVY T/BTM HDRS HVY STEEL FINS	T	S	5	9	BH BH	9 9	37 9/16 37 9/16	C C	42 42	F F	C	266461
42 13/16	39 15/16	4 1/2	CATERPILLAR	D-7 HVY T/BTM HDRS BRASS FINS RVS CTR MTG BAR	T	B	6	7	BH BH	6 9/16 6 9/16	41 1/2 41 1/2	C C	38 38	E E	F	264016
42 13/16	40	2 15/16	CATERPILLAR	D-7 3S3565 HVY T/BTM HDRS HVY STEEL FINS SGL CTR MTG BAR 4 CRNRS NOTCHED	Z	S	4	6	BH BH	6 9/16 6 9/16	41 1/2 41 1/2	1 1/4 1 1/4	38 38	E E	F	225864
42 13/16	40	4 7/16	CATERPILLAR	D-7F 3R2605 HVY T/BTM HDRS BRASS FINS RVS CTR MTG BAR 4 CRNRS NOTCHED	Z	B	6	9	BH BH	6 9/16 6 9/16	41 1/2 41 1/2	C C	38 38	E E	F	225052
42 13/16	40	4 7/16	CATERPILLAR	D-7F 3R2605 HVY T/BTM HDRS BRASS FINS SGL CTR MTG BAR 4 CRNRS NOTCHED	Z	B	6	9	BH BH	6 9/16 6 9/16	41 1/2 41 1/2	C C	38 38	E E	F	225117
42 13/16	40	4 7/16	CATERPILLAR	D-7F 3S4069 HVY T/BTM HDRS HVY STEEL FINS SGL CTR MTG BAR 4 CRNRS NOTCHED	Z	S	6	9	BH BH	6 9/16 6 9/16	41 1/2 41 1/2	C C	38 38	E E	F	225845
42 13/16	40	4 1/2	CATERPILLAR	D-7F HVY T/BTM HDRS BRASS FINS FACE DIPPED RVS CTR MTG BAR	B	B	6	7	BH BH	6 9/16 6 9/16	41 1/2 41 1/2	C C	38 38	E E	F	229568
42 13/16	40	4 1/2	CATERPILLAR	D-7 HVY T/BTM HDRS SGL CTR MTG BAR BRASS FINS	B	B	6	7	BH BH	6 9/16 6 9/16	41 1/2 41 1/2	C C	38 38	E E	F	229612

Vista-Pro Automotive - Core Catalog

(Cores Sorted by Application)

Height	Width	Depth	Application	Description	Fin Type	Fin Matl	Rows	FPI	BH / TH Type	BH / TH Width	BH / TH Length	BH / TH OHF	BH / TH Bolts	BH / TH Shape	Hdr Support	Part #
CATERPILLAR (Cont)																
42 13/16	40 1/2	4 1/2	CATERPILLAR	816B COMPACTOR HVY T/BTM HDRS HVY STEEL FINS	T	S	6	7	BH BH	9 9	43 5/8 43 5/8	C C	50 50	A A	CC	266455
42 13/16	40 5/8	3 11/16	CATERPILLAR	8N3108 HVY T/BTM HDRS	Z	C	5	9	BH BH	9 9	43 5/8 43 5/8	C C	50 50	A A	CC	225122
42 13/16	40 5/8	4 7/16	CATERPILLAR	816B 8N5382, 8N5471 HVY T/BTM HDRS HVY STEEL FINS	Z	S	6	6	BH BH	9 9	43 5/8 43 5/8	C C	50 50	A A	F	225860
42 7/8	42 1/2	3 11/16	CATERPILLAR	D343, D353 2N5125 HVY T/BTM HDRS BRASS FINS	Z	B	5	9	BH BH	8 8	45 1/2 45 1/2	C C	54 54	A A	CC	225397
42 7/8	42 1/2	3 3/4	CATERPILLAR	D353 HVY T/BTM HDRS BRASS FINS FACE DIPPED	B	B	5	6	BH BH	8 8	45 1/2 45 1/2	C C	54 54	A A	CC	277136
42 7/8	42 3/4	3 3/4	CATERPILLAR	D353 HVY T/BTM HDRS	T	C	5	9	BH BH	8 8	45 1/2 45 1/2	C C	54 54	A A	CC	272605
42 7/8	42 3/4	4 1/2	CATERPILLAR	D343, D353 HVY T/BTM HDRS	T	C	6	10	BH BH	8 8	45 1/2 45 1/2	C C	54 54	A A	CC	265604
43 1/2	39 3/8	2 15/16	CATERPILLAR	D-7G 4N7279 HVY T/BTM HDRS HVY STEEL FINS SGL CTR MTG BAR	Z	S	4	9	BH BH	7 7/8 7 7/8	43 3/4 41	2 1/8 2 1/8	44 40	G A	F	225929
43 1/2	39 3/8	4 7/16	CATERPILLAR	D-7G HVY T/BTM HDRS BRASS FINS SGL CTR MTG BAR	Z	B	6	9	BH BH	7 7/8 7 7/8	43 7/8 41	1 5/16 1 5/16	46 40	G A	F	225089
43 1/2	39 3/8	4 7/16	CATERPILLAR	D-7G 6N1218 HVY T/BTM HDRS BRASS FINS SGL CTR MTG BAR	Z	B	6	9	BH BH	7 7/8 7 7/8	43 3/4 41	1 1/4 1 1/4	44 40	F A	F	225148
43 1/2	39 3/8	4 7/16	CATERPILLAR	D-7G 6N1218 HVY T/BTM HDRS HVY STEEL FINS SGL CTR MTG BAR	Z	S	6	9	BH BH	7 7/8 7 7/8	43 3/4 41	1 1/4 1 1/4	44 40	F A	F	225815
43 1/2	39 3/8	4 1/2	CATERPILLAR	D-7G HVY T/BTM HDRS BRASS FINS SGL CTR MTG BAR	T	B	6	7	BH BH	7 7/8 7 7/8	43 3/4 41	1 3/8 1 3/8	44 40	G A	F	265492
43 1/2	39 3/8	4 1/2	CATERPILLAR	D-7G HVY T/BTM HDRS BRASS FINS SGL CTR MTG BAR	T	B	6	7	BH BH	7 7/8 7 7/8	43 3/4 41	1 1/4 1 1/4	46 40	G A	F	265879
43 1/2	39 3/8	5 3/16	CATERPILLAR	D-7G 7N2343 HVY T/BTM HDRS BRASS FINS SGL CTR MTG BAR	Z	B	7	9	BH BH	7 7/8 7 7/8	43 3/4 41	C C	44 40	G A	F	225146
43 1/2	39 1/2	4 1/2	CATERPILLAR	D-7G HVY T/BTM HDRS SGL CTR MTG BAR BRASS FINS FACE DIPPED	B	B	6	7	BH BH	7 7/8 7 7/8	43 3/4 41	1 3/8 1 3/8	44 40	G A	F	229545
43 1/2	39 1/2	4 1/2	CATERPILLAR	D-7G HVY T/BTM HDRS SGL CTR MTG BAR BRASS FINS	B	B	6	7	BH BH	7 7/8 7 7/8	43 3/4 41	1 3/8 1 3/8	44 40	G A	F	229614
44 5/16	40	6	CATERPILLAR	824, 834 2S2433 HVY T/BTM HDRS BRASS FINS 4 CRNRS OF CORE NOTCHED	Z	B	8	9	BH BH	8 8	41 1/4 41 1/4	C C	40 40	F F	F	225165
44 5/16	40	6	CATERPILLAR	824, 834 9S6157 HVY T/BTM HDRS HVY STEEL FINS 4 CRNRS OF CORE NOTCHED	Z	S	8	9	BH BH	8 8	41 1/4 41 1/4	C C	40 40	F F	F	225873
44 5/16	40 1/2	6	CATERPILLAR	HVY T/BTM HDRS BRASS FINS FACE DIPPED 4 CRNRS OF CORE NOTCHED	B	B	8	6	BH BH	8 8	41 1/4 41 1/4	C C	40 40	F F	CC	275441
44 3/8	36	6	CATERPILLAR	988 HVY T/BTM HDRS 4 CRNRS NOTCHED OFFSET FOR O/C	T	C	8	7	BH BH	8 8	41 3/8 37 3/8	C C	40 36	F F	C	275392
44 3/8	36 1/4	6	CATERPILLAR	988 LOADER 9S4103 HVY T/BTM HDRS BRASS FINS 4 CRNRS NOTCHED OFFSET FOR O/C	Z	B	8	9	BH BH	8 8	41 1/4 37 1/4	C C	40 36	F F	F	225037

Vista-Pro Automotive - Core Catalog

(Cores Sorted by Application)

Height	Width	Depth	Application	Description	Fin Type	Fin Matl	Rows	FPI	BH / TH Type	BH / TH Width	BH / TH Length	BH / TH OHF	BH / TH Bolts	BH / TH Shape	Hdr Support	Part #					
CATERPILLAR (Cont)																					
44	3/8	36	1/4	6	CATERPILLAR	988 LOADER 9S4103 HVY T/BTM HDRS HVY STEEL FINS 4 CRNRS NOTCHED OFFSET FOR O/C	Z	S	8	9	BH	8	41	1/4	C	40	F	F	225846		
											BH	8	37	1/4	C	36	F	F			
44	15/16	38	3/4	5	3/16	CATERPILLAR	824, 825, 826 6N9785 HVY T/BTM HDRS BRASS FINS CTR SUPPORT FINS	Z	B	7	9	BH	8	7/8	C	42	A	C	225202		
											BH	8	7/8	C	42	A	A	C			
44	15/16	38	3/4	6	CATERPILLAR	824, 825, 826 8N3062, 8N3064 HVY T/BTM HDRS BRASS FINS CTR SUPPORT FINS	Z	B	8	9	BH	8	7/8	C	42	A	F	F	225201		
											BH	8	7/8	C	42	A	A	F			
44	15/16	38	3/4	6	CATERPILLAR	824, 825, 826 8N3062, 8N3064 HVY T/BTM HDRS BRASS FINS CTR SUPPORT FINS	Z	S	8	9	BH	8	7/8	C	42	A	F	F	225816		
											BH	8	7/8	C	42	A	A	F			
44	15/16	39	5	1/4	CATERPILLAR	824C HVY T/BTM HDRS BRASS FINS FACE DIPPED	B	B	7	7	BH	8	7/8	C	42	A	C	C	272585		
											BH	8	7/8	C	42	A	A	C			
44	15/16	39	6	CATERPILLAR	824C HVY T/BTM HDRS BRASS FINS FACE DIPPED	B	B	8	7	BH	8	7/8	C	42	A	C	C	C	272586		
											BH	8	7/8	C	42	A	A	C			
45	47	13/16	3	3/4	CATERPILLAR	3406 HVY T/BTM HDRS	T	C	5	9	BH	13	50	2	1/4	54	A	CC	223621		
											BH	9	50	2	1/4	50	A	CC			
45	47	13/16	4	1/2	CATERPILLAR	3408, 3412 HVY T/BTM HDRS	T	C	6	9	BH	13	50	2	1/4	54	A	CC	223114		
											BH	9	50	2	1/4	50	A	CC			
45	47	13/16	5	1/4	CATERPILLAR	3408 HVY T/BTM HDRS	T	C	7	9	BH	13	50	2	1/4	54	A	CC	266463		
											BH	9	50	2	1/4	50	A	CC			
45	48	1/8	3	11/16	CATERPILLAR	3408, 3412 8N4880 HVY BTM HDR BRASS FINS REINFORCED T/HDR	Z	B	5	9	BH	13	50	2	1/4	54	A	F	225196		
											BH	9	50	2	1/4	50	A	F			
45	48	1/8	4	7/16	CATERPILLAR	3408, 3412 4N8559 HVY T/BTM HDR BRASS FINS REINFORCED T/HDR	Z	B	6	9	BH	13	50	2	1/4	54	A	F	225195		
											BH	9	50	2	1/4	50	A	F			
45	48	1/8	5	3/16	CATERPILLAR	3408, 3412 HVY BTM HDR BRASS FINS REINFORCED T/HDR	Z	B	7	9	BH	13	50	2	1/4	54	A	CC	225197		
											BH	9	50	2	1/4	50	A	CC			
45	1/4	45	3	11/16	CATERPILLAR	245 EXCAVATOR 4N9471 HVY T/BTM HDRS	Z	C	5	9	BH	8	7/8	49	7/8	1	1/2	50	A	CC	225156
											BH	8	7/8	49	7/8	1	1/2	50	A	CC	
45	1/4	45	5	3/16	CATERPILLAR	245 EXCAVATOR 6N413 HVY T/BTM HDRS HVY STEEL FINS	Z	S	7	9	BH	8	7/8	49	7/8	C	50	A	F	225830	
											BH	8	7/8	49	7/8	C	50	A	F		
45	1/4	45	6	CATERPILLAR	245 SHOVEL 9Y3311 HVY T/BTM HDRS BRASS FINS	Z	B	8	9	BH	8	7/8	49	7/8	1	1/2	50	A	CC	225162	
											BH	8	7/8	49	7/8	1	1/2	50	A	CC	
45	5/16	43	3/4	3	11/16	CATERPILLAR	980C 6N9786 HVY T/BTM HDR BRASS FINS CTR SUPPORT FINS	Z	B	5	9	BH	8	7/8	46	3/4	C	48	A	CC	225203
											BH	8	7/8	46	3/4	C	48	A	CC		
45	5/16	43	3/4	3	11/16	CATERPILLAR	980C 6N9786 HVY T/BTM HDR HVY STEEL FINS CTR SUPPORT FINS	Z	S	5	9	BH	8	7/8	46	3/4	C	48	A	CC	225819
											BH	8	7/8	46	3/4	C	48	A	CC		
45	5/16	43	7/8	3	3/4	CATERPILLAR	980C HVY T/BTM HDRS HVY STEEL FINS	T	S	5	9	BH	8	7/8	46	3/4	C	48	A	CC	266464
											BH	8	7/8	46	3/4	C	48	A	CC		
45	5/16	44	3	3/4	CATERPILLAR	980C HVY T/BTM HDRS BRASS FINS FACE DIPPED	B	B	5	7	BH	8	7/8	46	3/4	C	48	A	CC	272811	
											BH	8	7/8	46	3/4	C	48	A	CC		
45	1/2	42	1/2	3	11/16	CATERPILLAR	D-8H 8S2646-HVY T/BTM HDRS BRASS FINS SGL CTR MTG BAR	Z	B	5	9	BH	6	9/16	45	1/2	C	40	F	F	225207
											BH	6	9/16	45	1/2	C	40	F	F		
45	1/2	42	1/2	4	7/16	CATERPILLAR	D-8H 8S2639 8S2645 HVY T/BTM HDRS BRASS FINS SGL CTR MTG BAR	Z	B	6	9	BH	6	9/16	45	1/2	C	40	F	F	225033
											BH	6	9/16	45	1/2	C	40	F	F		
45	1/2	42	1/2	4	7/16	CATERPILLAR	D-8H 8S2645 8S2639 HVY T/BTM HDRS BRASS FINS RVS CTR MTG BAR	Z	B	6	9	BH	6	9/16	45	1/2	C	40	F	F	225093
											BH	6	9/16	45	1/2	C	40	F	F		

Vista-Pro Automotive - Core Catalog

(Cores Sorted by Application)

Height	Width	Depth	Application	Description	Fin Type	Fin Matl	Rows	FPI	BH/TH Type	BH/TH Width	BH/TH Length	BH/TH OHF	BH/TH Bolts	BH/TH Shape	Hdr Support	Part #
45 1/2	42 1/2	4 7/16	CATERPILLAR	D-8H 8S2639 HVY T/BTM HDRS HVY STEEL FINS SGL CTR MTG BAR	Z	S	6	9	BH BH	6 9/16 6 9/16	45 1/2 45 1/2	C C	40 40	F F	F F	225820
45 1/2	42 1/2	4 7/16	CATERPILLAR	D-8H 8S2639 8S2645 HVY T/BTM HDRS HVY STEEL FINS RVS CTR MTG BAR	Z	S	6	9	BH BH	6 9/16 6 9/16	45 1/2 45 1/2	C C	40 40	F F	F F	225877
45 1/2	42 1/2	4 1/2	CATERPILLAR	D-8H HVY T/BTM HDRS SGL CTR MTG BAR BRASS FINS	B	B	6	7	BH BH	6 9/16 6 9/16	45 1/2 45 1/2	C C	40 40	F F	F F	229617
45 1/2	42 1/2	4 1/2	CATERPILLAR	D-8H HVY T/BTM HDRS RVS CTR MTG BAR BRASS FINS	B	B	6	7	BH BH	6 5/8 6 5/8	45 1/2 45 1/2	C C	40 40	F F	F F	229618
45 1/2	42 1/2	4 1/2	CATERPILLAR	D-8H HVY T/BTM HDRS RVS CTR MTG BAR BRASS FINS FACE DIPPED	B	B	6	7	BH BH	6 9/16 6 9/16	45 1/2 45 1/2	C C	40 40	F F	F F	229619
45 1/2	42 3/4	4 1/2	CATERPILLAR	D-8H 8S2639 HVY T/BTM HDRS BRASS FINS RVS CTR MTG BAR	T	B	6	7	BH BH	6 9/16 6 9/16	45 1/2 45 1/2	C C	40 40	F F	F F	223071
45 1/2	45	4 7/16	CATERPILLAR	D-8K 6N880 HVY T/BTM HDRS BRASS FINS 4 CRNRS NOTCHED RVS CTR MTG BAR	Z	B	6	9	BH BH	8 8	46 5/8 46 5/8	C C	42 42	F F	F F	225155
45 1/2	45	4 1/2	CATERPILLAR	D-8K 6N880 HVY T/BTM HDRS BRASS FINS RVS CTR MTG BAR 4 CRNRS OF CORE NOTCHED	T	B	6	7	BH BH	8 8	46 5/8 46 5/8	C C	42 42	F F	F F	265580
45 1/2	45	6	CATERPILLAR	D-8K 6N957 HVY T/BTM HDRS BRASS FINS RVS CTR MTG BAR 4 CRNRS OF CORE NOTCHED	T	B	8	7	BH BH	8 8	46 5/8 46 5/8	C C	42 42	F F	F F	223115
45 1/2	45	6	CATERPILLAR	D-8K 6N957 HVY T/BTM HDRS BRASS FINS 4 CRNRS NOTCHED RVS CTR MTG BAR	Z	B	8	9	BH BH	8 8	46 5/8 46 5/8	C C	42 42	F F	F F	225121
45 1/2	45	6	CATERPILLAR	D-8K 6N957 HVY T/BTM HDRS HVY STEEL FINS 4 CRNRS NOTCHED RVS CTR MTG BAR	Z	S	8	9	BH BH	8 8	46 5/8 46 5/8	C C	42 42	F F	F F	225871
45 1/2	45	6	CATERPILLAR	D-8K 6N957 HVY T/BTM HDRS RVS CTR MTG BAR BRASS FINS FACE DIPPED 4 CRNRS NOTCHED	B	B	8	7	BH BH	8 8	46 5/8 46 5/8	C C	42 42	F F	F F	229509
45 1/2	45	6	CATERPILLAR	D-8K 6N957 HVY T/BTM HDRS RVS CTR MTG BAR BRASS FINS 4 CRNRS NOTCHED	B	B	8	7	BH BH	8 8	46 5/8 46 5/8	C C	42 42	F F	F F	229615
45 1/2	45	6	CATERPILLAR	D-8K 6N957 HVY T/BTM HDRS RVS CTR MTG BAR BRASS FINS FACE DIPPED 4 CRNRS NOTCHED	B	B	8	7	BH BH	8 8	46 5/8 46 5/8	C C	42 42	F F	F F	229616
45 3/4	25 5/8	3 11/16	CATERPILLAR	973 1W6833 HVY T/BTM HDRS 4 CRNRS OF CORE NOTCHED	Z	C	5	9	BH BH	9 13/16 9 13/16	28 1/16 28 1/16	C C	34 34	F F	C C	225229
45 3/4	25 5/8	3 11/16	CATERPILLAR	973 1W6833 HVY T/BTM HDRS HVY STEEL FINS 4 CRNRS OF CORE NOTCHED	Z	S	5	9	BH BH	9 13/16 9 13/16	28 1/16 28 1/16	C C	34 34	F F	C C	225928
45 3/4	25 5/8	4 7/16	CATERPILLAR	973 LOADER 8N9135 HVY T/BTM HDRS BRASS FINS 4 CRNRS OF CORE NOTCHED	Z	B	6	9	BH BH	9 13/16 9 13/16	28 1/16 28 1/16	C C	34 34	F F	C C	225191
45 3/4	25 5/8	4 7/16	CATERPILLAR	973 LOADER 8N9135 HVY T/BTM HDRS HVY STEEL FINS 4 CRNRS OF CORE NOTCHED	Z	S	6	9	BH BH	9 13/16 9 13/16	28 1/16 28 1/16	C C	34 34	F F	C C	225868
45 3/4	25 5/8	5 3/16	CATERPILLAR	973 8N6492 HVY T/BTM HDRS BRASS FINS 4 CRNRS OF CORE NOTCHED	Z	B	7	9	BH BH	9 13/16 9 13/16	28 1/16 28 1/16	C C	34 34	F F	C C	225228

Vista-Pro Automotive - Core Catalog

(Cores Sorted by Application)

Height	Width	Depth	Application	Description	Fin Type	Fin Matl	Rows	FPI	BH / TH Type	BH / TH Width	BH / TH Length	BH / TH OHF	BH / TH Bolts	BH / TH Shape	Hdr Support	Part #
CATERPILLAR (Cont)																
45 3/4	25 5/8	5 3/16	CATERPILLAR	973 8N6492 HVY T/BTM HDRS HVY STEEL FINS 4 CRNRS OF CORE NOTCHED	Z	S	7	9	BH BH	9 13/16 9 13/16	28 1/16 28 1/16	C C	34 34	F F	C	225948
45 3/4	25 7/8	3 3/4	CATERPILLAR	973 HVY T/BTM HDRS 4 CRNRS OF CORE NOTCHED	T	C	5	10	BH BH	9 15/16 9 15/16	28 1/8 28 1/8	C C	34 34	F F	C	266493
45 3/4	25 7/8	4 1/2	CATERPILLAR	973 HVY T/BTM HDRS HVY STEEL FINS 4 CRNRS OF CORE NOTCHED	T	S	6	9	BH BH	9 13/16 9 13/16	28 1/16 28 1/16	C C	34 34	F F	C	266474
46	45	5 3/16	CATERPILLAR	641, 651, 660 8S4070 HVY T/BTM HDRS BRASS FINS	Z	B	7	8	BH BH	8 8	47 7/16 47 7/16	C C	46 46	F F	CC	225400
46	45 1/2	5 1/4	CATERPILLAR	641, 651, 660, 666 HVY T/BTM HDRS BRASS FINS	B	B	7	7	BH BH	8 8	47 7/16 47 7/16	C C	46 46	F F	CC	229620
46 1/2	48 1/8	6	CATERPILLAR	834, 835 9S6156 HVY T/BTM HDRS HVY STEEL FINS 4 CRNRS OF CORE NOTCHED	Z	S	8	9	BH BH	8 8	49 1/2 49 1/2	C C	46 46	A A	CC	225914
47 1/2	40	6	CATERPILLAR	5Z5933 HVY T/BTM HDRS BRASS FINS CTR SUPPORT FINS	Z	B	8	6	BH BH	9 11/16 9 11/16	45 7/8 45 7/8	C C	52 52	A A	C	225537
47 1/2	43 1/8	5 3/16	CATERPILLAR	D-8L 7N3112 HVY T/BTM HDRS BRASS FINS CTR SUPPORT FINS	Z	B	7	9	BH BH	9 11/16 9 11/16	45 7/8 45 7/8	C C	52 52	A A	CC	225178
47 1/2	43 1/8	5 3/16	CATERPILLAR	D-8L 7N3112 HVY T/BTM HDRS HVY STEEL FINS CTR SUPPORT FINS	Z	S	7	9	BH BH	9 11/16 9 11/16	45 7/8 45 7/8	C C	52 52	A A	F	225854
47 1/2	43 5/16	5 1/4	CATERPILLAR	D-8L HVY T/BTM HDR HVY STEEL FINS	T	S	7	9	BH BH	9 11/16 9 11/16	45 7/8 45 7/8	C C	52 52	A A	CC	266466
47 1/2	43 1/2	5 1/4	CATERPILLAR	D-8L HVY T/BTM HDRS CTR SUPPORT FINS BRASS FINS FACE DIPPED	B	B	7	7	BH BH	9 11/16 9 11/16	45 7/8 45 7/8	C C	52 52	A A	CC	229561
47 1/2	43 1/2	5 1/4	CATERPILLAR	D-8L HVY T/BTM HDRS CTR SUPPORT FINS BRASS FINS	B	B	7	7	BH BH	9 11/16 9 11/16	45 7/8 45 7/8	C C	52 52	A A	F	229621
47 1/2	43 3/4	4 7/16	CATERPILLAR	973 8N2343 HVY T/BTM HDRS HVY STEEL FINS CTR SUPPORT FINS	Z	S	6	9	BH BH	8 7/8 8 7/8	46 3/4 46 3/4	C C	48 48	A A	CC	225915
48	46 1/8	3	CATERPILLAR	HVY T/BTM HDRS	T	C	4	8	BH BH	9 1/4 9 1/4	48 1/4 48 1/4	4 1/2 4 1/2	60 60	F F	CC	266604
48 1/4	47 1/4	5 1/4	CATERPILLAR	637 SCRAPER HVY T/BTM HDRS HVY STEEL FINS	T	S	7	7	BH BH	8 7/8 8 7/8	49 7/8 49 7/8	1 1/2 1 1/2	50 50	A A	CC	266363
48 1/4	47 1/2	4 7/16	CATERPILLAR	988B 7N1097 HVY T/BTM HDRS HVY STEEL FINS	Z	S	6	9	BH BH	8 7/8 8 7/8	49 7/8 49 7/8	C C	50 50	A A	F	225821
48 1/4	47 1/2	5 3/16	CATERPILLAR	631D, 633D, 637D 7N9314 HVY T/BTM HDRS BRASS FINS SGL CTR MTG BAR	Z	B	7	9	BH BH	8 7/8 8 7/8	49 7/8 49 7/8	1 1/2 1 1/2	50 50	A A	F	225193
48 1/4	47 1/2	5 3/16	CATERPILLAR	631D, 633D, 637D 7N9314 HVY T/BTM HDRS HVY STEEL FINS SGL CTR MTG BAR	Z	S	7	9	BH BH	8 7/8 8 7/8	49 7/8 49 7/8	1 1/2 1 1/2	50 50	A A	F	225829
48 1/4	47 1/2	5 1/4	CATERPILLAR	631 SCRAPER HVY T/BTM HDRS SGL CTR MTG BAR BRASS FINS FACE DIPPED	B	B	7	7	BH BH	8 7/8 8 7/8	49 7/8 49 7/8	C C	50 50	A A	F	272593
48 1/4	47 1/2	6	CATERPILLAR	988B 4N9691 HVY T/BTM HDRS BRASS FINS	Z	B	8	9	BH BH	8 7/8 8 7/8	49 7/8 49 7/8	C C	50 50	A A	F	225143
48 1/4	47 1/2	6	CATERPILLAR	637 SCRAPER 4N7241 HVY T/BTM HDRS BRASS FINS	Z	B	8	9	BH BH	8 3/4 8 3/4	49 7/8 49 7/8	C C	48 48	A A	CC	225401
48 1/4	47 1/2	6	CATERPILLAR	988B 4N9691 HVY T/BTM HDRS HVY STEEL FINS	Z	S	8	9	BH BH	8 7/8 8 7/8	49 7/8 49 7/8	C C	50 50	A A	F	225855

Vista-Pro Automotive - Core Catalog

(Cores Sorted by Application)

Height	Width	Depth	Application	Description	Fin Type	Fin Matl	Rows	FPI	BH / TH Type	BH / TH Width	BH / TH Length	BH / TH OHF	BH / TH Bolts	BH / TH Shape	Hdr Support	Part #
CATERPILLAR (Cont)																
48 1/4	47 1/2	6	CATERPILLAR	631, 633, 637 SCRAPER HVY T/BTM HDRS BRASS FINS FACE DIPPED	B	B	8	7	BH BH	8 7/8 8 7/8	49 7/8 49 7/8	C C	48 48	A A	CC	229547
48 1/4	47 1/2	6	CATERPILLAR	988B LOADER HVY T/BTM HDRS BRASS FINS FACE DIPPED	B	B	8	7	BH BH	8 7/8 8 7/8	49 7/8 49 7/8	C C	50 50	A A	CC	229565
48 1/4	47 1/2	6	CATERPILLAR	631, 633, 637 SCRAPER HVY T/BTM HDRS BRASS FINS	B	B	8	7	BH BH	8 7/8 8 7/8	49 7/8 49 7/8	C C	48 48	A A	CC	229622
48 1/4	47 1/2	6	CATERPILLAR	988B LOADER HVY T/BTM HDRS BRASS FINS	B	B	8	7	BH BH	8 7/8 8 7/8	49 7/8 49 7/8	C C	50 50	A A	CC	229623
48 1/4	47 13/16	6	CATERPILLAR	988B HVY T/BTM HDRS BRASS FINS FACE DIPPED	T	B	8	7	BH BH	8 7/8 8 7/8	49 7/8 49 7/8	C C	50 50	A A	CC	272606
48 5/16	47 1/2	4 7/16	CATERPILLAR	988B 4W4987 HVY T/BTM HDRS BRASS FINS CTR SUPPORT FINS	Z	B	6	9	BH BH	8 7/8 8 7/8	49 7/8 49 7/8	C C	50 50	A A	CC	225065
48 5/16	47 1/2	4 7/16	CATERPILLAR	988B 4W4987 HVY T/BTM HDRS HVY STEEL FINS CTR SUPPORT FINS	Z	S	6	9	BH BH	8 7/8 8 7/8	49 7/8 49 7/8	C C	50 50	A A	CC	225947
48 5/16	47 1/2	5 3/16	CATERPILLAR	769C 4W4986 HVY T/BTM HDRS BRASS FINS CTR SUPPORT FINS	Z	B	7	9	BH BH	8 7/8 8 7/8	49 7/8 49 7/8	C C	50 50	A A	F	225075
48 5/16	47 1/2	5 3/16	CATERPILLAR	769C 4W4986 HVY T/BTM HDRS HVY STEEL FINS CTR SUPPORT FINS	Z	S	7	9	BH BH	8 7/8 8 7/8	49 7/8 49 7/8	C C	50 50	A A	CC	225918
48 5/16	47 1/2	5 1/4	CATERPILLAR	769C 35 TON HAUL TRUCK HVY T/BTM HDRS CTR SUPPORT FINS BRASS FINS	B	B	7	7	BH BH	8 7/8 8 7/8	49 7/8 49 7/8	C C	50 50	A A	CC	229566
48 5/16	47 1/2	6	CATERPILLAR	1W6861 HVY T/BTM HDRS BRASS FINS CTR SUPPORT FINS	Z	B	8	9	BH BH	8 7/8 8 7/8	49 7/8 49 7/8	C C	50 50	A A	F	225066
50	37 1/2	6	CATERPILLAR	983 7S2538 HVY T/BTM HDRS HVY STEEL FINS	Z	S	8	9	BH BH	8 1/4 8 1/4	38 3/4 38 3/4	C C	38 38	A A	F	225866
50	48 3/8	3 3/4	CATERPILLAR	HVY T/BTM HDRS	T	C	5	9	BH BH	7 1/4 7 1/4	50 50	C C	58 58	A A	CC	272816
50	49 1/2	5 1/4	CATERPILLAR	D353 3408 STATIONARY HVY T/BTM HDRS	T	C	7	10	BH BH	7 1/2 7 1/2	51 3/4 51 3/4	C C	62 62	A A	CC	272814
51	47 13/16	3 3/4	CATERPILLAR	3412 GEN SET HVY T/BTM HDRS	T	C	5	9	BH BH	13 9	50 50	2 1/4 2 1/4	54 50	A A	F	223072
51	47 13/16	4 1/2	CATERPILLAR	3412 GEN SET HVY T/BTM HDRS	T	C	6	9	BH BH	13 9	50 50	2 1/4 2 1/4	54 50	A A	CC	223073
51	48 1/8	3 11/16	CATERPILLAR	3412 4N8995 HVY BTM HDR BRASS FINS REINFORCED T/HDR	Z	B	5	9	BH BH	13 9	50 50	2 1/4 2 1/4	54 50	A A	F	225404
51	48 1/8	4 7/16	CATERPILLAR	3412 GEN SET 8N4885 HVY BTM HDR BRASS FINS REINFORCED T/HDR	Z	B	6	9	BH BH	13 9	50 50	2 1/4 2 1/4	54 50	A A	F	225200
51	60	4 7/16	CATERPILLAR	HVY T/BTM HDRS BRASS FINS	Z	B	6	9	BH BH	8 1/8 8 1/8	62 62	C C	74 74	A A	F	225181
51 1/4	46 1/4	5 3/16	CATERPILLAR	D-9G, 9S9022 HVY T/BTM HDRS BRASS FINS SGL CTR MTG BAR	Z	B	7	9	BH BH	6 7/8 6 7/8	48 1/2 48 1/2	C C	44 44	F F	F	225069
51 1/4	46 1/4	6	CATERPILLAR	D-9H, 6N973 HVY T/BTM HDRS BRASS FINS RVS CTR MTG BAR	Z	B	8	9	BH BH	8 8	49 49	C C	44 44	F F	F	225085
51 1/4	46 1/4	6	CATERPILLAR	D-9H, 6N973 HVY T/BTM HDRS HVY STEEL FINS RVS CTR MTG BAR	Z	S	8	9	BH BH	8 8	49 49	C C	44 44	F F	F	225822

Vista-Pro Automotive - Core Catalog

(Cores Sorted by Application)

Height	Width	Depth	Application	Description	Fin Type	Fin Matl	Rows	FPI	BH / TH Type	BH / TH Width	BH / TH Length	BH / TH OHF	BH / TH Bolts	BH / TH Shape	Hdr Support	Part #	
CATERPILLAR (Cont)																	
51	1/4	46 1/2	6	CATERPILLAR	D-9H 6N973 HVY T/BTM HDRS RVS CTR MTG BAR BRASS FINS FACE DIPPED	B	B	8	7	BH	8	49	C	44	F	F	229548
51	1/4	46 1/2	6	CATERPILLAR	D-9H 6N973 HVY T/BTM HDRS RVS CTR MTG BAR BRASS FINS	B	B	8	7	BH	8	49	C	44	F	F	229624
52	51	4 1/2	6	CATERPILLAR	641B, 651B SCRAPER 1P6101 HVY T/BTM HDRS BRASS FINS	B	B	6	7	BH	8	54 3/8	C	54	F	CC	229626
52	51	6	6	CATERPILLAR	773 6N9376 HVY T/BTM HDRS BRASS FINS FACE DIPPED	B	B	8	7	BH	8	54 3/8	C	54	F	CC	229569
52	51 3/16	4 1/2	6	CATERPILLAR	641, 651 SCRAPER HVY T/BTM HDRS BRASS FINS	T	B	6	8	BH	8	54 3/8	C	50	F	CC	265027
52	51 1/4	4 7/16	6	CATERPILLAR	641B, 651B, 657B 1P6101 HVY T/BTM HDRS BRASS FINS	Z	B	6	9	BH	8	54 3/8	C	54	F	F	225053
52	51 1/4	4 7/16	6	CATERPILLAR	641B, 651B, 657B 1P6101 HVY T/BTM HDRS HVY STEEL FINS	Z	S	6	9	BH	8	54 3/8	C	54	F	F	225856
52	51 1/4	6	6	CATERPILLAR	773 HAUL TRUCK 6N9376 HVY T/BTM HDRS BRASS FINS	Z	B	8	9	BH	8	54 3/8	C	54	F	CC	225145
52 1/8	51 1/4	4 7/16	6	CATERPILLAR	641B, 651B, 657B 7N3694 HVY T/BTM HDRS BRASS FINS CTR SUPPORT FINS	Z	B	6	9	BH	8	54 3/8	C	50	F	CC	225054
52 1/8	51 1/4	4 7/16	6	CATERPILLAR	641B, 651B, 657B 7N3694 HVY T/BTM HDRS HVY STEEL FINS CTR SUPPORT FINS	Z	S	6	9	BH	8	54 3/8	C	50	F	CC	225930
54 1/8	50 5/8	5 3/16	6	CATERPILLAR	D-9L 7N2191 HVY T/BTM HDRS BRASS FINS CTR SUPPORT FINS	Z	B	7	9	BH	9 9/16	53 1/2	C	56	A	CC	225192
54 1/8	50 5/8	5 3/16	6	CATERPILLAR	D-9L 7N2191 HVY T/BTM HDRS HVY STEEL FINS CTR SUPPORT FINS	Z	S	7	9	BH	9 9/16	53 1/2	C	56	A	F	225878
54 1/8	50 5/8	6	6	CATERPILLAR	773B HAUL TRUCK 8N66 HVY T/BTM HDRS BRASS FINS CTR SUPPORT FINS	Z	B	8	9	BH	9 9/16	53 1/2	C	56	A	CC	225225
54 1/8	51	5 1/4	6	CATERPILLAR	D-9L HVY T/BTM HDRS CTR SUPPORT FINS BRASS FINS FACE DIPPED	B	B	7	7	BH	9 9/16	53 1/2	C	56	A	CC	229511
54 1/8	51	5 1/4	6	CATERPILLAR	D-9L HVY T/BTM HDRS CTR SUPPORT FINS BRASS FINS FACE DIPPED	B	B	7	7	BH	9 5/8	53 1/2	C	56	A	F	229628
54 1/8	51	6	6	CATERPILLAR	773B 50 TON HAUL TRUCK 8N66 HVY T/BTM HDRS CTR SUPPORT FINS BRASS FINS FACE DIPPED	B	B	8	7	BH	9 5/8	53 1/2	C	56	A	CC	229582
54 1/8	51	6	6	CATERPILLAR	773B 50 TON HAUL TRUCK 8N66 HVY T/BTM HDRS CTR SUPPORT FINS BRASS FINS FACE DIPPED	B	B	8	7	BH	9 9/16	53 1/2	C	56	A	F	229629
54 1/8	51 3/16	5 1/4	6	CATERPILLAR	D-9L HVY T/BTM HDRS CTR SUPPORT FINS	T	C	7	9	BH	9 9/16	53 1/2	C	56	A	CC	266371
58 1/2	57 1/2	2 3/16	6	CATERPILLAR	777 AFTERCOOLER 6N1939 HVY T/BTM HDRS HVY STEEL FINS	Z	S	3	9	BH	6 1/2	59 7/8	C	54	A	CC	225946
58 1/2	57 1/2	6	6	CATERPILLAR	777 85 TON TRUCK 6N9377 HVY T/BTM HDRS BRASS FINS	Z	B	8	9	BH	8 3/4	59 7/8	C	56	A	F	225161
58 1/2	57 1/2	6	6	CATERPILLAR	777 85 TON TRUCK HVY T/BTM HDRS BRASS FINS FACE DIPPED	B	B	8	7	BH	8 3/4	59 7/8	C	56	A	F	272609

Vista-Pro Automotive - Core Catalog

(Cores Sorted by Application)

Height	Width	Depth	Application	Description	Fin Type	Fin Matl	Rows	FPI	BH / TH Type	BH / TH Width	BH / TH Length	BH / TH OHF	BH / TH Bolts	BH / TH Shape	Hdr Support	Part #	
CATERPILLAR (Cont)																	
58	5/8	57 3/8	6	CATERPILLAR	992C HVY T/BTM HDRS BRASS FINS RVS CTR MTG BAR	T	B	8	7	BH BH	9 3/8 9 3/8	59 7/8 59 7/8	C C	58 58	A A	F	266449
58	5/8	57 1/2	5 3/16	CATERPILLAR	D-10 7N9061 HVY T/BTM HDRS BRASS FINS RVS CTR MTG BAR	Z	B	7	9	BH BH	9 3/8 9 3/8	59 7/8 59 7/8	C C	58 58	A A	F	225166
58	5/8	57 1/2	5 3/16	CATERPILLAR	D-10 7N9061 HVY T/BTM HDRS HVY STEEL FINS RVS CTR MTG BAR	Z	S	7	9	BH BH	9 3/8 9 3/8	59 7/8 59 7/8	C C	58 58	A A	F	225879
58	5/8	57 1/2	6	CATERPILLAR	992C LOADER 6N7661 HVY T/BTM HDRS BRASS FINS RVS CTR MTG BAR	Z	B	8	9	BH BH	9 3/8 9 3/8	59 7/8 59 7/8	C C	58 58	A A	F	225226
58	5/8	57 1/2	6	CATERPILLAR	992C LOADER 1N3921 HVY T/BTM HDRS HVY STEEL FINS RVS CTR MTG BAR	Z	S	8	9	BH BH	9 3/8 9 3/8	59 7/8 59 7/8	C C	58 58	A A	F	225899
58	5/8	57 1/2	6	CATERPILLAR	992C LOADER 1N3921, 6N7661 HVY T/BTM HDRS RVS CTR MTG BAR BRASS FINS FACE DIPPED	B	B	8	7	BH BH	9 3/8 9 3/8	59 7/8 59 7/8	C C	58 58	A A	F	229592
58	5/8	57 1/2	6	CATERPILLAR	992C LOADER 1N3921, 6N7661 HVY T/BTM HDRS BRASS FINS FACE DIPPED RVS CTR MTG BAR	B	B	8	7	BH BH	9 3/8 9 3/8	59 7/8 59 7/8	C C	58 58	A A	F	229630
CATERPILLAR (LeMASTER ASSEMBLY) <Call Dallas Location to Confirm Correct Part with the Bottom Tank Number>																	
24	11/16	26 1/4	4 7/16	CAT-LeMASTER	508 SKIDDER 4W8922 GROUP REPL 6 CORES BRASS FINS	Z	B	6	7	BH BH	6 1/2 6 1/2	25 1/2 25 1/2	C C	32 32	0 0	C	284240
29	1/8	24 3/4	4 1/2	CAT-LeMASTER	D-4 REPL 4 CORES BRASS FINS	T	B	6	7	BH BH	6 1/2 6 1/2	25 25	C C	32 32	0 0	C	274170
29	1/8	24 3/4	4 1/2	CAT-LeMASTER	D-4H (IMRM) 2W6509, 8N7031 GROUPS REPL 5 CORES BRASS FINS	T	B	6	7	BH BH	6 1/2 6 1/2	25 25	C C	32 32	0 0	C	274222
29	1/8	25	4 7/16	CAT-LeMASTER	D-4 REPL 4 CORES BRASS FINS	Z	B	6	7	BH BH	6 1/2 6 1/2	25 25	C C	32 32	A A	C	284170
29	1/8	25	4 7/16	CAT-LeMASTER	D-4H (IMRM) 2W6509, 8N7031 GROUP REPL 5 CORES BRASS FINS	Z	B	6	7	BH BH	6 1/2 6 1/2	25 25	C C	32 32	A A	C	284222
29	1/8	28 3/4	4 7/16	CAT-LeMASTER	916, 928, IT28 1W9441 GROUP REPL 4 CORES BRASS FINS	Z	B	6	7	BH BH	6 1/2 6 1/2	29 29	C C	34 34	A A	C	284172
29	1/8	29 1/4	4 1/2	CAT-LeMASTER	916, 928, IT28 1W9441 GROUP REPL 4 CORES BRASS FINS	T	B	6	7	BH BH	6 1/2 6 1/2	29 29	C C	34 34	0 0	C	274172
29	1/8	31 7/8	5 3/16	CAT-LeMASTER	936E WO/AC 1W4553 GROUP REPL 5 CORES BRASS FINS	Z	B	7	7	BH BH	7 7	32 32	C C	38 38	0 0	C	284148
29	1/8	31 7/8	5 3/16	CAT-LeMASTER	936E W/AC 1W4555 GROUP REPL 8 CORES BRASS FINS	Z	B	7	7	BH BH	7 7	32 32	C C	38 38	0 0	C	284182
29	1/8	32 1/16	5 1/4	CAT-LeMASTER	936 WO/AC 1W4553 GROUP REPL 5 CORES BRASS FINS	T	B	7	7	BH BH	7 7	32 32	C C	38 38	0 0	C	274148
30	7/8	26 7/8	4 7/16	CAT-LeMASTER	D-5H 9Y8531, 8N9536 GROUPS REPL 6 CORES BRASS FINS	Z	B	6	7	BH BH	6 1/2 6 1/2	27 27	C C	34 34	0 0	C	284210
32	3/8	31 1/4	4 7/16	CAT-LeMASTER	D-6D 1W9285 GROUP REPL 8 CORES BRASS FINS	Z	B	6	7	BH BH	6 1/2 6 1/2	31 1/2 31 1/2	C C	38 38	0 0	C	284140
33	7/8	35 5/8	5 3/16	CAT-LeMASTER	3406 GEN SET REPL 8 CORES BRASS FINS	Z	B	7	7	BH BH	7 7	36 3/8 36 3/8	C C	42 42	0 0	C	284132
33	7/8	36	5 1/4	CAT-LeMASTER	3406 GEN SET REPL 8 CORES BRASS FINS	T	B	7	7	BH BH	7 7	36 36	C C	42 42	0 0	C	274132
36	1/8	32 1/2	5 3/16	CAT-LeMASTER	950E W/OC** 4W1181 GROUP REPL 7 CORES BRASS FINS O/C 441000 AVAIL	Z	B	7	7	BH BH	7 7	33 33	C C	40 40	A A	C	284144

Vista-Pro Automotive - Core Catalog

(Cores Sorted by Application)

Height	Width	Depth	Application	Description	Fin Type	Fin Matl	Rows	FPI	BH/TH Type	BH/TH Width	BH/TH Length	BH/TH OHF	BH/TH Bolts	BH/TH Shape	Hdr Support	Part #
CATERPILLAR (LeMASTER ASSEMBLY) (Cont) <Call Dallas Location to Confirm Correct Part with the Bottom Tank Number>																
36	1/8	33 3/16	5 1/4	CAT-LeMASTER	950E W/OC** 4W1181 GROUP REPL 7 CORES BRASS O/C 441000 AVAIL	T	B	7	7	BH	7	C	40	0	C	274144
										BH	7	C	40	0		
36	1/8	35	5 3/16	CAT-LeMASTER	627E REAR SCRAPER 7E7991, 2W0410 GROUPS REPL 7 CORES BRASS FINS	Z	B	7	7	BH	7	C	42	0	C	284184
										BH	7	C	42	0		
36	1/8	35	5 3/16	CAT-LeMASTER	637E REAR SCRAPER 4W8062 GROUP REPL 9 CORES BRASS FINS	Z	B	7	7	BH	7	C	42	0	C	284154
										BH	7	C	42	0		
39	3/16	31 7/8	5 3/16	CAT-LeMASTER	966D W/OC** & 815B, 816C 2W7934 & 7W2793 GROUPS REPL 10 CORES BRASS FINS 441001 O/C AVAIL	Z	B	7	7	BH	7	C	40	0	C	284146
										BH	7	C	40	0		
39	3/16	31 7/8	5 3/16	CAT-LeMASTER	966E W/OC** & 816B 2W7919 GROUP REPL 8 CORES BRASS FINS 441001 O/C AVAIL	Z	B	7	7	BH	7	C	40	0	C	284192
										BH	7	C	40	0		
39	3/16	31 7/8	5 3/16	CAT-LeMASTER	D-6H W/OC** 7C8900 GROUP REPL 7 CORES BRASS FINS 441001 O/C AVAIL	Z	B	7	7	BH	7	C	40	0	C	284122
										BH	7	C	40	0		
39	3/16	31 7/8	5 3/16	CAT-LeMASTER	D-6H (IMRM) W/OC 7E9509 REPL 8 CORES BRASS FINS 441001 O/C AVAIL	Z	B	7	7	BH	7	C	40	0	C	284254
										BH	7	C	40	0		
39	3/16	32 1/16	5 1/4	CAT-LeMASTER	966E W/OC** & 816B 2W7919 GROUP REPL 8 CORES BRASS 441001 O/C AVAIL	T	B	7	7	BH	7	C	40	0	C	274192
										BH	7	C	40	0		
39	3/16	32 1/16	5 1/4	CAT-LeMASTER	D-6H W/OC** 7C8900 GROUP REPL 7 CORES BRASS 441001 O/C AVAIL	T	B	7	7	BH	7	C	40	0	C	274122
										BH	7	C	40	0		
39	3/16	36 7/8	5 3/16	CAT-LeMASTER	D-8N (IMRM) REPL 8 CORES BRASS FINS	Z	B	7	9	BH	7	C	44	0	C	284130
										BH	7	C	44	0		
39	3/16	36 7/8	5 3/16	CAT-LeMASTER	D-6H (IMRM) 7C6564 GROUP REPL 6 CORES BRASS FINS	Z	B	7	9	BH	7	C	44	0	C	284142
										BH	7	C	44	0		
39	3/16	36 7/8	5 3/16	CAT-LeMASTER	D-6H W/AC 1W0039 REPL 12 CORES BRASS FINS	Z	B	7	7	BH	7	C	44	0	C	284220
										BH	7	C	44	0		
39	3/16	36 7/8	5 3/16	CAT-LeMASTER	D-6H, D-7G, D-8N 9Y3165, 2W3530, 7W0149 GROUPS REPLACES 8 & 10 COOLING SECTIONS BRASS FINS	Z	B	7	7	BH	7	C	44	A	C	284194
										BH	7	C	44	A		
39	3/16	36 7/8	5 3/16	CAT-LeMASTER	D-8N W/AC 4W9888 REPL 12 CORES BRASS FINS	Z	B	7	7	BH	7	C	44	0	C	284180
										BH	7	C	44	0		
39	3/16	37 1/8	5 1/4	CAT-LeMASTER	D-8N (IMRM) REPL 8 CORES BRASS FINS	T	B	7	9	BH	7	C	44	0	C	274130
										BH	7	C	44	0		
39	3/16	37 1/8	5 1/4	CAT-LeMASTER	D-6H W/AC 1W0039 REPL 12 CORES BRASS FINS	T	B	7	7	BH	7	C	44	0	C	274220
										BH	7	C	44	0		
39	3/16	37 1/8	5 1/4	CAT-LeMASTER	D-6H, D-7G, D-8N 9Y3165, 2W3530, 7W0149 GROUPS REPL 8 & 10 CORES BRASS FINS	T	B	7	7	BH	7	C	44	0	C	274194
										BH	7	C	44	0		
39	3/16	37 1/8	5 1/4	CAT-LeMASTER	D-8N W/AC 4W9888 REPL 12 CORES BRASS FINS	T	B	7	7	BH	7	C	44	0	C	274180
										BH	7	C	44	0		
39	3/16	37 1/2	5 3/16	CAT-LeMASTER	D-7G REPL 12 CORES BRASS FINS	Z	B	7	7	BH	7	C	44	0	C	284274
										BH	7	C	44	0		
39	3/16	38 1/8	5 3/16	CAT-LeMASTER	627E, 637E FRONT 4W8495 REPL 10 CORES BRASS FINS	Z	B	7	7	BH	7	C	46	A	C	284156
										BH	7	C	46	A		
39	3/16	39 15/16	5 1/4	CAT-LeMASTER	627E, 637E FRONT 4W8495 REPL 10 CORES BRASS FINS	T	B	7	7	BH	7	C	46	0	CC	274156
										BH	7	C	46	0		
39	3/16	42 1/2	5 3/16	CAT-LeMASTER	3408 GEN SET REPL 9 CORES BRASS FINS	Z	B	7	7	BH	7	C	48	0	CC	284268
										BH	7	C	48	0		

Vista-Pro Automotive - Core Catalog

(Cores Sorted by Application)

Height	Width	Depth	Application	Description	Fin Type	Fin Matl	Rows	FPI	BH / TH Type	BH / TH Width	BH / TH Length	BH / TH OHF	BH / TH Bolts	BH / TH Shape	Hdr Support	Part #
CATERPILLAR (LeMASTER ASSEMBLY) (Cont) <Call Dallas Location to Confirm Correct Part with the Bottom Tank Number>																
39	3/16	44 3/8	5 3/16	CAT-LeMASTER	826G w/IMRM REPL 9 CORES BRASS FINS	Z	B	7	7	BH BH	7 7	C	54	0	CC	284200
40	3/4	34 3/8	5 3/16	CAT-LeMASTER	980C w/OC** REPL 15 SECTIONS	Z	C	7	7	BH BH	7 7	C	42	0	C	284298
40	3/4	34 7/8	5 1/4	CAT-LeMASTER	980C W/OC 1W8649 GROUP REPL 11 CORES BRASS 441003 O/C AVAIL	T	B	7	7	BH BH	7 7	C	40	0	C	274150
40	3/4	35	5 3/16	CAT-LeMASTER	980C W/OC 1W8649 GROUP REPL 11 CORES BRASS FINS441003 O/C AVAIL	Z	B	7	7	BH BH	7 7	C	40	A	C	284150
40	3/4	38 3/4	5 3/16	CAT-LeMASTER	825, 826C W/OC ** 2W0037 GROUP REPL 13 CORES BRASS FINS441004 O/C AVAIL	Z	B	7	7	BH BH	7 7	C	46	0	F	284166
40	3/4	38 13/16	5 1/4	CAT-LeMASTER	825, 826C W/OC ** 2W0037 GROUP REPL 13 CORES BRASS 441004 O/C AVAIL	T	B	7	7	BH BH	7 7	C	46	0	C	274166
40	3/4	43 1/8	5 3/16	CAT-LeMASTER	980F (IMRM) REPL 9 CORES BRASS FINS	Z	B	7	9	BH BH	7 7	C	48	0	CC	284224
40	3/4	43 5/16	5 1/4	CAT-LeMASTER	980F (IMRM) REPL 9 CORES BRASS FINS	T	B	7	9	BH BH	7 7	C	48	0	CC	274224
43	3/4	42 1/2	5 3/16	CAT-LeMASTER	D-8L W/AC REPL 14 CORES BRASS FINS	Z	B	7	7	BH BH	7 7	C	50	0	CC	284228
43	3/4	42 1/2	5 3/16	CAT-LeMASTER	D-8L WO/AC 4W1796 GROUP REPL 14 CORES BRASS FINS	Z	B	7	7	BH BH	7 7	C	50	A	CC	284174
43	3/4	42 3/4	5 1/4	CAT-LeMASTER	D-8L W/AC REPL 14 CORES BRASS FINS	T	B	7	7	BH BH	7 7	C	50	0	CC	274228
43	3/4	42 3/4	5 1/4	CAT-LeMASTER	D-8L WO/AC 4W1796 GROUP REPL 14 CORES BRASS FINS	T	B	7	7	BH BH	7 7	C	50	0	CC	274174
43	3/4	43 1/8	5 3/16	CAT-LeMASTER	657E SCRAPER REPL 9 CORES	Z	C	7	7	BH BH	7 7	C	50	0	CC	284280
43	3/4	43 3/4	5 3/16	CAT-LeMASTER	D-9N WO/AC 7W2847 REPL 15 CORES BRASS FINS	Z	B	7	7	BH BH	7 7	C	50	A	CC	284102
43	3/4	43 3/4	5 3/16	CAT-LeMASTER	D-8N (IMRM) REPL 9 CORES BRASS FINS	Z	B	7	9	BH BH	7 7	C	50	A	CC	284162
43	3/4	43 3/4	5 3/16	CAT-LeMASTER	D-9N W/AC 7W8887 REPL 16 CORES BRASS FINS	Z	B	7	7	BH BH	7 7	C	50	0	CC	284164
43	3/4	43 7/8	5 1/4	CAT-LeMASTER	D-9N WO/AC 7W2847 REPL 15 CORES BRASS FINS	T	B	7	7	BH BH	7 7	C	50	0	CC	274102
43	3/4	43 7/8	5 1/4	CAT-LeMASTER	D-8N (IMRM) REPL 9 CORES BRASS FINS	T	B	7	9	BH BH	7 7	C	50	0	CC	274162
43	3/4	43 7/8	5 1/4	CAT-LeMASTER	D-9N W/AC 7W8887 REPL 16 CORES BRASS FINS	T	B	7	7	BH BH	7 7	C	50	0	CC	274164
43	3/4	45 5/8	5 3/16	CAT-LeMASTER	3408 GEN SET REPL 10 CORES BRASS FINS	Z	B	7	7	BH BH	7 7	C	52	0	CC	284272
43	3/4	47 1/4	5 1/4	CAT-LeMASTER	631E, 637E FRONT 2W0029 REPL 11 CORES BRASS FINS	T	B	7	7	BH BH	7 7	C	54	0	CC	274104
43	3/4	47 1/4	5 1/4	CAT-LeMASTER	769C 35 TON TRUCK 2W1991 GROUP REPL 15 CORES BRASS FINS	T	B	7	7	BH BH	7 7	C	54	0	CC	274238
43	3/4	47 1/4	5 1/4	CAT-LeMASTER	988B REPL 13 CORES BRASS FINS	T	B	7	7	BH BH	7 7	C	54	0	CC	274152
43	3/4	47 1/2	5 3/16	CAT-LeMASTER	631E, 637E FRONT 2W0029 REPL 11 CORES BRASS FINS	Z	B	7	7	BH BH	7 7	C	54	A	CC	284104

Vista-Pro Automotive - Core Catalog

(Cores Sorted by Application)

Height	Width	Depth	Application	Description	Fin Type	Fin Matl	Rows	FPI	BH / TH Type	BH / TH Width	BH / TH Length	BH / TH OHF	BH / TH Bolts	BH / TH Shape	Hdr Support	Part #
CATERPILLAR (LeMASTER ASSEMBLY) (Cont) <Call Dallas Location to Confirm Correct Part with the Bottom Tank Number>																
43 3/4	47 1/2	5 3/16	CAT-LeMASTER	789C 35 TON TRUCK 2W1991 GROUP REPL 15 CORES BRASS FINS	Z	B	7	7	BH BH	7 7	47 5/8 47 5/8	C C	54 54	0 0	CC	284238
43 3/4	47 1/2	5 3/16	CAT-LeMASTER	988B REPL 16 CORES BRASS FINS	Z	B	7	7	BH BH	7 7	47 1/2 47 1/2	C C	54 54	0 0	CC	284232
43 3/4	47 1/2	5 3/16	CAT-LeMASTER	988B REPL 13 CORES BRASS FINS	Z	B	7	7	BH BH	7 7	47 5/8 47 5/8	C C	54 54	0 0	CC	284152
43 3/4	50 5/8	5 3/16	CAT-LeMASTER	3412 GEN SET REPL 11 CORES BRASS FINS	Z	B	7	7	BH BH	7 7	51 51	C C	54 54	0 0	CC	284270
50 3/4	50 5/8	5 3/16	CAT-LeMASTER	3412 GEN SET REPL 11 CORES BRASS FINS	Z	B	7	8	BH BH	7 7	51 51	C C	60 60	0 0	CC	284276
50 3/4	50 5/8	5 3/16	CAT-LeMASTER	651E, 657E FRONT 4W2786 GROUP REPL 16 CORES BRASS FINS	Z	B	7	7	BH BH	7 7	50 1/2 50 1/2	C C	60 60	A A	CC	284158
50 3/4	51 3/4	5 1/4	CAT-LeMASTER	D-10N w/IMRM 4Q5657 GROUP REPL 11 CORES BRASS FINS	T	B	7	7	BH BH	7 7	52 52	C C	58 58	0 0	CC	274282
50 3/4	51 7/8	5 3/16	CAT-LeMASTER	D-10N w/IMRM 4Q5657 GROUP REPL 11 CORES BRASS FINS	Z	B	7	7	BH BH	7 7	52 52	C C	58 58	0 0	CC	284282
50 3/4	52 1/2	5 3/16	CAT-LeMASTER	D-10N W/OAC REPL 18 CORES BRASS FINS	Z	B	7	7	BH BH	7 7	53 53	C C	60 60	0 0	CC	284110
50 3/4	52 1/2	5 3/16	CAT-LeMASTER	D-10N W/OAC REPL 19 CORES BRASS FINS	Z	B	7	7	BH BH	7 7	52 1/2 52 1/2	C C	60 60	0 0	CC	284136
50 3/4	52 7/8	5 1/4	CAT-LeMASTER	D-10N W/OAC REPL 19 CORES BRASS FINS	T	B	7	7	BH BH	7 7	52 1/2 52 1/2	C C	60 60	0 0	CC	274136
57 7/8	60	5 3/16	CAT-LeMASTER	3508, 3512 GEN SET 7W3699 REPL 13 CORES BRASS FINS	Z	B	7	7	BH BH	7 7	60 1/2 60 1/2	C C	68 68	0 0	CC	284264
57 7/8	60	5 3/16	CAT-LeMASTER	D-11N 8N8702 GROUP REPL 21 CORES BRASS FINS	Z	B	7	7	BH BH	7 7	60 1/2 60 1/2	C C	68 68	0 0	CC	284100
57 7/8	60	5 3/16	CAT-LeMASTER	D-11N w/IMRM 8N8702 GROUP REPL 12 CORES BRASS FINS	Z	B	7	7	BH BH	7 7	60 1/2 60 1/2	C C	68 68	0 0	CC	284116
57 7/8	60 3/16	5 1/4	CAT-LeMASTER	D-11N 8N8702 GROUP REPL 21 CORES BRASS FINS	T	B	7	7	BH BH	7 7	60 1/2 60 1/2	C C	68 68	0 0	CC	274100
58	55 5/8	5 3/16	CAT-LeMASTER	988F LOADER w/IMRM 4P2488 GROUP REPL 12 CORES BRASS FINS	Z	B	7	7	BH BH	7 7	56 56	C C	62 62	A A	CC	284168
58	56 1/4	5 1/4	CAT-LeMASTER	988F LOADER w/IMRM 4P2488 GROUP REPL 12 CORES BRASS FINS	T	B	7	7	BH BH	7 7	56 56	C C	62 62	0 0	CC	274168
61 3/4	62 1/2	5 3/16	CAT-LeMASTER	777C 85 TON TRUCK REPL 23 CORES BRASS FINS	Z	B	7	7	BH BH	7 7	63 63	C C	70 70	0 0	CC	284186
69 3/8	72	5 1/4	CAT-LeMASTER	785B 130 TON TRUCK REPL 26 CORES BRASS FINS	T	B	7	7	BH BH	7 7	72 72	C C	86 86	0 0	CC	274178
69 3/8	78 3/4	5 3/16	CAT-LeMASTER	3512, 3516 GEN SET 7W7666 REPL 25 CORES BRASS FINS	Z	B	7	7	BH BH	7 7	79 79	C C	86 86	0 0	CC	284256
69 3/8	78 3/4	5 1/4	CAT-LeMASTER	3512, 3516 GEN SET 7W7666 REPL 25 CORES BRASS FINS	T	B	7	7	BH BH	7 7	79 79	C C	86 86	0 0	CC	274256
CHAMPION																
26 7/8	33 3/4	4 1/2	CHAMPION	GRADER HYV T/BTM HDRS	T	C	6	8	BH BH	7 7	36 3/8 36 3/8	C C	44 44	A A	C	272823
CHEVROLET																
12	14 7/8	1 1/4	CHEVROLET	CHEVETTE	VT	C	2	12	GR GR	2 3/4 2 3/4	16 1/2 16 1/2	3/8 3/8		A A	N	124785
13 1/2	17 1/16	1 1/4	CHEVROLET	LUV	VT	C	2	12	GR GR	2 7/8 2	16 7/8 16 7/8	C C		A A	N	124679

Vista-Pro Automotive - Core Catalog

(Cores Sorted by Application)

Height	Width	Depth	Application	Description	Fin Type	Fin Matl	Rows	FPI	BH/TH Type	BH/TH Width	BH/TH Length	BH/TH OHF	BH/TH Bolts	BH/TH Shape	Hdr Support	Part #
CHEVROLET (Cont)																
14 1/8	18 11/16	1 1/4	CHEVROLET		VT	C	2	12	GR	2 1/4	18 1/2	C		A	N	122382
									GR	2 1/4	18 1/2	C		A	N	122331
14 1/8	18 11/16	2	CHEVROLET		VT	C	3	12	GR	2 1/4	18 1/2	C		A	N	122331
									GR	2 1/4	18 1/2	C		A	N	122331
15 1/2	23 1/8	2	CHEVROLET		VT	C	3	14	GR	2 1/2	23 1/2	C		A	N	122601
									FR	2 1/16	23 1/2	C		A	N	122601
15 1/2	25 5/16	2	CHEVROLET		VT	C	3	12	GR	2 1/2	25 7/16	C		A	N	122294
									GR	2 1/2	25 7/16	C		A	N	122294
15 9/16	17 1/16	2	CHEVROLET	LUV	VT	C	3	14	GR	2 5/8	16 3/4	3/8		A	N	128666
									GR	2	16 3/4	C		A	N	128666
16 7/8	14 7/8	1 1/4	CHEVROLET		VT	C	2	12	GR	2 3/4	16 1/2	3/8		A	N	124979
									GR	2 1/16	16 1/2	3/8		A	N	124979
16 7/8	14 7/8	1 1/4	CHEVROLET	CHEVETTE	VT	C	2	12	GR	2 3/4	16 1/2	3/8		A	N	124787
									GR	2 3/4	16 1/2	3/8		A	N	124787
16 7/8	14 7/8	2	CHEVROLET	CHEVETTE	VT	C	3	12	GR	2 3/4	16 1/2	C		A	N	124788
									GR	2 3/4	16 1/2	C		A	N	124788
16 7/8	15 1/4	1	CHEVROLET		VE	C	2	14	GR	2 3/8	16 1/2	C		A	N	128105
									GR	2 3/8	16 1/2	C		A	N	128105
17	23 1/8	1 1/4	CHEVROLET		VT	C	2	12	GR	2 1/2	23 1/2	C		A	N	122380
									GR	2	23 1/2	C		A	N	122380
17	25 5/16	1 1/4	CHEVROLET		VT	C	2	12	GR	2 1/2	25 7/16	C		A	N	128778
									GR	2 1/2	25 7/16	C		A	N	128778
17	25 5/16	2	CHEVROLET		VT	C	3	12	GR	2 1/2	25 7/16	C		A	N	122360
									GR	2 1/2	25 7/16	C		A	N	122360
17 3/8	18 11/16	1 1/4	CHEVROLET		VT	C	2	12	GR	2 1/4	18 1/2	3/8		A	N	122462
									GR	2 1/4	18 1/2	3/8		A	N	122462
17 3/8	18 11/16	2	CHEVROLET		VT	C	3	12	GR	2 1/4	18 1/2	C		A	N	122401
									GR	2 1/4	18 1/2	C		A	N	122401
17 3/8	19 1/4	2	CHEVROLET		VT	C	3	12	GR	2 1/2	19 3/8	C		A	N	122557
									GR	2 1/2	19 3/8	C		A	N	122557
17 3/8	23 1/8	1 1/4	CHEVROLET		VT	C	2	12	GR	2 1/2	23 1/2	3/8		A	N	122569
									GR	2	23 1/2	C		A	N	122569
17 3/8	23 1/8	2	CHEVROLET		VT	C	3	13	GR	2 3/4	25 7/16	C		A	N	122556
									GR	2 3/4	25 7/16	C		A	N	122556
19 13/16	19 1/4	1 1/4	CHEVROLET		VT	C	2	12	BU	3 11/16	19 1/2	C		A	N	128602
									GR	2 1/2	19 3/8	C		A	N	128602
20 3/8	14 7/8	1 1/4	CHEVROLET		VT	C	2	16	GR	2 3/4	16 1/2	3/16		A	N	124731
									GR	2 3/4	16 1/2	3/16		A	N	124731
20 3/4	17 1/16	1 1/4	CHEVROLET		VT	C	2	12	GR	2 3/4	18 5/8	C		A	N	122411
									GR	2 3/4	18 5/8	C		A	N	122411
20 3/4	17 1/16	1 1/4	CHEVROLET		VT	C	2	13	GR	2 1/16	18 5/8	C		A	N	124953
									GR	2 3/4	18 5/8	7/16		A	N	124953
22 1/2	17 1/16	2 5/8	CHEVROLET	CORVETTE	VT	C	4	12	GR	3 1/2	18 5/8	C		A	N	122515
									GR	3 7/16	18 5/8	C		A	N	122515
23 5/8	15 1/4	1	CHEVROLET		VE	C	2	14	GR	2 3/8	16 1/2	3/8		A	N	128106
									GR	2 3/8	16 1/2	3/8		A	N	128106
24 3/4	23 1/8	1 1/4	CHEVROLET		VT	C	2	12	GR	3	25 7/16	3/8		A	N	122451
									GR	2 3/4	25 7/16	3/8		A	N	122451
24 3/4	23 1/8	2	CHEVROLET		VT	C	3	12	GR	2 3/4	25 7/16	C		A	N	122369
									GR	2 3/4	25 7/16	C		A	N	122369
24 3/4	23 1/8	2	CHEVROLET		VT	C	3	12	GR	3	25 7/16	C		A	N	122476
									GR	2 3/4	25 7/16	C		A	N	122476
26	17 1/16	2 5/8	CHEVROLET	CORVETTE	VT	C	4	12	GR	3 1/2	18 5/8	C		A	N	122599
									GR	3 7/16	18 5/8	C		A	N	122599

Vista-Pro Automotive - Core Catalog

(Cores Sorted by Application)

Height	Width	Depth	Application	Description	Fin Type	Fin Matl	Rows	FPI	BH / TH Type	BH / TH Width	BH / TH Length	BH / TH OHF	BH / TH Bolts	BH / TH Shape	Hdr Support	Part #
CHEVROLET (Cont)																
26 3/8	19 1/4	2 5/8	CHEVROLET		VT	C	4	12	GR GR	3 1/2 3 1/2	20 7/8 20 7/8	C C		A A	N	122655
CHRYSLER																
15 1/8	18 11/16	1 1/4	CHRYSLER		VT	C	2	14	GR GR	2 7/8 1 3/4	18 1/4 18 1/2	3/16 C		A A	N	128398
15 3/4	16 1/2	1 1/4	CHRYSLER		VT	C	2	16	GR GR	1 7/8 1 7/8	16 5/8 16 5/8	C C		A A	N	128729
16 3/4	18 11/16	2	CHRYSLER		VT	C	3	12	BU FR	4 2 1/16	19 1/4 18 1/2	1/2 C		A A	N	122329
16 3/4	19 1/4	2	CHRYSLER		VT	C	3	12	BU FR	4 2 1/16	19 1/4 19	C C		A A	N	122357
16 3/4	22	2	CHRYSLER		VT	C	3	12	BU GR	4 2 7/8	22 1/4 21 3/4	7/16 C		A A	N	128630
16 7/8	22	1 1/4	CHRYSLER		VT	C	2	14	GR GR	3 3/8 2	21 5/8 21 3/4	FF FF		A A	N	124544
16 7/8	22	2	CHRYSLER		VT	C	3	12	GR GR	3 3/8 2 3/4	21 5/8 21 5/8	3/16 3/16		0 A	N	124546
17	18 11/16	1 1/4	CHRYSLER		VT	C	2	14	GR GR	2 7/8 1 3/4	18 1/4 18 1/2	C C		A A	N	128409
17	22	2	CHRYSLER		VT	C	3	12	BU GR	4 2 7/8	22 1/4 21 3/4	FF FF		A A	N	124505
17 1/8	22	1 1/4	CHRYSLER		VT	C	2	12	BU GR	4 2	22 1/4 21 1/2	C C		A A	N	128620
17 1/8	22	2	CHRYSLER		VT	C	3	12	BU GR	4 2 1/4	22 1/4 21 7/8	C C		A A	N	122465
17 3/8	18 11/16	2	CHRYSLER		VT	C	3	12	GR GR	2 7/8 2 1/8	18 1/4 18 1/2	C C		A A	N	128628
17 1/2	19 1/4	1 1/4	CHRYSLER		VT	C	2	12	BU GR	4 1 3/4	19 1/4 19	FF FF		A A	N	122554
17 1/2	22	1 1/4	CHRYSLER		VT	C	2	12	BU GR	4 2	22 1/4 21 3/4	FR FR		A A	N	122563
17 1/2	22	1 1/4	CHRYSLER		VT	C	2	12	GR GR	3 3/8 2	21 5/8 21 3/4	1/4 1/4		A A	N	124582
17 1/2	22	1 1/4	CHRYSLER		VT	C	2	14	BU GR	4 2	22 1/4 21 5/8	FR FR		A A	N	128319
17 1/2	22	2	CHRYSLER		VT	C	3	12	BU GR	4 2 1/4	22 1/4 21 3/4	FR FR		A A	N	122581
17 1/2	22	2	CHRYSLER		VT	C	3	12	BU GR	4 2 1/2	22 1/4 22	C C		A A	N	122574
17 1/2	22	2	CHRYSLER		VT	C	3	12	BU GR	4 2 11/16	22 1/4 21 9/16	C C		A A	N	128626
17 1/2	22	2	CHRYSLER		VT	C	3	12	GR GR	3 3/8 2 1/8	21 5/8 21 5/8	3/16 C		A A	N	128627
17 1/2	25 7/8	1 1/4	CHRYSLER		VT	C	2	14	GR GR	3 2	25 9/16 25 9/16	3/8 3/8		A A	N	122564
17 1/2	25 7/8	1 1/4	CHRYSLER		VT	C	2	12	GR GR	3 2 5/16	25 9/16 25 9/16	C C		A A	N	128623
17 1/2	25 7/8	2	CHRYSLER		VT	C	3	14	GR GR	3 2 3/4	25 9/16 25 9/16	C C		A A	N	122491
17 1/2	25 7/8	2	CHRYSLER		VT	C	3	12	GR FR	3 2 1/8	25 9/16 25 9/16	1/4 C		A A	N	128621
17 1/2	25 7/8	2	CHRYSLER		VT	C	3	12	GR GR	3 2 1/4	25 9/16 25 9/16	1/4 C		A A	N	124538
17 1/2	25 7/8	2 5/8	CHRYSLER		VT	C	4	12	GR FR	3 2 7/8	25 9/16 25 5/8	C C		A A	N	122493

Vista-Pro Automotive - Core Catalog

(Cores Sorted by Application)

Height	Width	Depth	Application	Description	Fin Type	Fin Matl	Rows	FPI	BH/TH Type	BH/TH Width	BH/TH Length	BH/TH OHF	BH/TH Bolts	BH/TH Shape	Hdr Support	Part #
CHRYSLER (Cont)																
17 5/8	20 3/8	2	CHRYSLER		VT	C	3	12	GR GR	2 1/2 2 1/2	20 1/2 20 1/2	C C		A A	N	128314
17 5/8	22	1 1/4	CHRYSLER		VT	C	2	14	BU GR	4 2	22 1/4 21 3/4	C C		A A	N	122239
17 3/4	22	2	CHRYSLER		VT	C	3	12	GR GR	3 3/8 2 1/4	21 5/8 21 5/8	FF C		A A	N	124825
17 3/4	27 1/2	2	CHRYSLER		VT	C	3	12	GR GR	3 2 11/16	27 1/4 27 1/4	C C		A A	N	124820
17 13/16	18 11/16	2	CHRYSLER		VT	C	3	12		2 7/8 2 1/8	18 1/4 18 1/2	1/8 C		0 0	N	128378
17 7/8	15 3/8	1 1/4	CHRYSLER		VT	C	2	13	GR GR	2 2	16 3/8 16 3/8	C C		A A	N	128272
17 7/8	22	2	CHRYSLER		VT	C	3	12	BU GR	4 2 1/4	22 1/4 21 3/4	FF C		A A	N	124640
17 7/8	22	2 5/8	CHRYSLER		VT	C	4	12	GR FR	3 3/8 2 3/4	21 5/8 21 5/8	C C		A A	N	128399
17 7/8	25 7/8	1 1/4	CHRYSLER		VT	C	2	12	GR GR	2 3/4 2	25 9/16 25 9/16	C C		A A	N	128641
17 7/8	25 7/8	2	CHRYSLER		VT	C	3	12	GR FR	2 3/4 2 1/8	25 9/16 25 9/16	C C		A A	N	124682
18	18 11/16	1 1/4	CHRYSLER		VT	C	2	12	GR GR	2 7/8 1 3/4	18 1/4 18 1/2	FF FF		A A	N	124506
18	18 11/16	1 1/4	CHRYSLER		VT	C	2	12	GR GR	1 3/4 1 3/4	18 1/2 18 1/2	C C		A A	N	124945
18	18 11/16	2	CHRYSLER		VT	C	3	12	GR GR	2 7/8 2 1/8	18 1/4 18 1/2	FF C		A A	N	128629
18	18 11/16	2 5/8	CHRYSLER		VT	C	4	12	GR GR	2 7/8 2 7/8	18 1/4 18 1/4	C C		A A	N	128430
18	22	1 1/4	CHRYSLER		VT	C	2	12	GR GR	2 3/4 2	21 5/8 21 5/8	FF FF		A A	N	124765
18	22	2	CHRYSLER		VT	C	3	12	GR GR	3 3/8 2 1/4	21 5/8 21 3/4	C C		A A	N	124662
18	22	2	CHRYSLER		VT	C	3	12	GR FR	2 3/4 2 1/8	21 5/8 21 5/8	C C		A A	N	128646
18	25 7/8	1 1/4	CHRYSLER		VT	C	2	14	GR GR	2 3/4 2	25 5/8 25 5/8	3/16 3/16		A A	N	122412
18	25 7/8	2	CHRYSLER		VT	C	3	12	GR GR	3 2 1/8	25 9/16 25 9/16	3/8 C		A A	N	122615
18	25 7/8	2	CHRYSLER		VT	C	3	16	GR GR	3 2 3/4	25 9/16 25 9/16	3/8 C		A A	N	128625
18	25 7/8	2	CHRYSLER		VT	C	3	16	GR GR	3 2 3/4	25 9/16 25 9/16	C C		A A	N	122495
18	25 7/8	2	CHRYSLER		VT	C	3	14	FR FR	2 1/8 2 1/8	25 9/16 25 9/16	C C		0 A	N	122630
18	25 7/8	2	CHRYSLER		VT	C	3	16		2 1/8 2 1/8	26 3/8 26 3/8	C C		0 0	N	128528
18	25 7/8	2 5/8	CHRYSLER		VT	C	4	12	GR FR	3 2 3/4	25 9/16 25 9/16	C C		A A	N	128664
18	26	1	CHRYSLER		VE	C	2	14	GR GR	1 3/4 1 3/4	26 1/4 26 1/4	C C		A A	N	124977
18 1/8	18 11/16	2	CHRYSLER		VT	C	3	12	BU FR	4 2 1/8	19 1/4 19 1/2	C C		A A	N	128341
18 1/8	22	1 1/4	CHRYSLER		VT	C	2	16	GR GR	1 3/4 1 3/4	22 5/16 22 5/16	C C		A A	N	124902

Vista-Pro Automotive - Core Catalog

(Cores Sorted by Application)

Height	Width	Depth	Application	Description	Fin Type	Fin Matl	Rows	FPI	BH/TH Type	BH/TH Width	BH/TH Length	BH/TH OHF	BH/TH Bolts	BH/TH Shape	Hdr Support	Part #
CHRYSLER (Cont)																
18 1/8	22	1 1/4	CHRYSLER		VT	C	2	14	BU GR	4 2	22 1/4 21 3/4	C C		A A	N	122470
18 1/8	22	1 1/4	CHRYSLER		VT	C	2	14	BU GR	4 2 1/4	22 1/4 21 1/2	C C		A A	N	128317
18 1/8	22	1 1/4	CHRYSLER		VT	C	2	14	BU GR	4 2	22 1/4 21 5/8	C C		A A	N	128318
18 1/8	22	2	CHRYSLER		VT	C	3	12	BU GR	4 2 1/4	22 5/16 21 3/4	FF C		A A	N	122237
18 1/8	22	2	CHRYSLER		VT	C	3	12	BU GR	4 2 7/8	22 1/4 21 3/4	C C		A A	N	122379
18 1/8	22	2	CHRYSLER		VT	C	3	12	BU GR	4 2 1/4	22 1/4 21 3/4	C C		A A	N	122387
18 1/8	22	2	CHRYSLER		VT	C	3	12	BU GR	4 2 1/4	22 1/4 21 3/4	FF C		A A	N	122399
18 1/8	22	2	CHRYSLER		VT	C	3	12	BU FR	4 2 1/8	22 1/4 21 1/2	C C		A A	N	128612
18 1/8	22	2 5/8	CHRYSLER		VT	C	4	12	BU GR	4 2 7/8	22 1/4 21 3/4	C C		A A	N	122398
18 1/8	27 1/2	1 1/4	CHRYSLER		VT	C	2	16	GR GR	3 2 3/4	27 1/2 27 1/2	C C		A A	N	122596
18 1/8	27 1/2	2 5/8	CHRYSLER		VT	C	4	12	GR GR	3 2 7/8	27 1/4 27 1/4	C C		A A	N	122552
18 1/4	20 1/4	3	CHRYSLER		T	C	4	9	GR GR	4 3 1/4	20 1/4 20 1/4	C C		A A	N	260661
18 3/8	18 11/16	2	CHRYSLER		VT	C	3	12	GR FR	2 7/8 2 1/8	18 1/4 18 1/2	1/8 C		A A	N	128447
18 3/8	19 1/4	1 1/4	CHRYSLER		VT	C	2	12	BU GR	4 1 3/4	19 1/4 19	C C		A A	N	122437
18 3/8	22	1 1/4	CHRYSLER		VT	C	2	14	BU GR	4 2	22 1/4 21 3/4	FF FF		A A	N	122435
18 3/8	22	1 1/4	CHRYSLER		VT	C	2	12		3 3/8 2	21 5/8 21 3/4	1/4 1/4		0 0	N	124542
18 3/8	22	2	CHRYSLER		VT	C	3	12	BU GR	4 2 1/2	22 1/4 21 3/4	C C		A A	N	128800
18 3/8	22	2	CHRYSLER		VT	C	3	12	BU GR	4 2 7/8	22 1/4 21 3/4	FF FF		A A	N	122423
18 3/8	22	2	CHRYSLER		VT	C	3	12	GR GR	4 2 1/2	22 1/4 21 3/4	C C		A A	N	122573
18 3/8	22	2	CHRYSLER		VT	C	3	12	GR GR	3 3/8 2 1/4	21 5/8 21 5/8	1/8 C		A A	N	124663
18 3/8	22	2	CHRYSLER		VT	C	3	12	GR GR	2 3/4 2 1/8	21 5/8 21 5/8	C C		A A	N	128392
18 1/2	20 3/8	2	CHRYSLER		VT	C	3	12	BX BX	2 1/2 2 1/2	20 1/2 20 1/2	C C		A A	N	128309
18 1/2	22	1 1/4	CHRYSLER		VT	C	2	12	BU GR	4 2	22 1/4 21 3/4	FF C		A A	N	122241
18 1/2	22 1/2	3	CHRYSLER		T	C	4	9	BU GR	4 1/4 3 3/8	23 22 5/8	C C		A A	N	260951
18 1/2	25 7/8	1 1/4	CHRYSLER		VT	C	2	14	GR GR	2 3/4 2	25 5/8 25 5/8	3/8 3/16		A A	N	124685
18 1/2	25 7/8	1 1/4	CHRYSLER		VT	C	2	16	GR GR	2 2	25 5/8 25 5/8	C C		A A	N	128411
18 1/2	25 7/8	1 1/4	CHRYSLER		VT	C	2	12	GR GR	3 2	25 9/16 25 9/16	3/8 3/8		A A	N	128642

Vista-Pro Automotive - Core Catalog

(Cores Sorted by Application)

Height	Width	Depth	Application	Description	Fin Type	Fin Matl	Rows	FPI	BH/TH Type	BH/TH Width	BH/TH Length	BH/TH OHF	BH/TH Bolts	BH/TH Shape	Hdr Support	Part #
CHRYSLER (Cont)																
18 1/2	25 7/8	2	CHRYSLER		VT	C	3	12	GR	2 3/4	25 9/16	3/16		A	N	124675
									FR	2 1/8	25 9/16	C		A		
18 1/2	25 7/8	2	CHRYSLER		VT	C	3	16	GR	2 3/4	25 9/16	C		A	N	124676
									GR	2 3/4	25 9/16	C		A		
18 1/2	25 7/8	2	CHRYSLER		VT	C	3	12	GR	2 3/4	25 9/16	C		A	N	124772
									GR	2 1/4	25 9/16	C		A		
18 5/8	22	2	CHRYSLER		VT	C	3	12	BU	4	22 1/4	FR		A	N	122589
									GR	2 1/4	21 3/4	C		A		
18 5/8	27 1/2	1 1/4	CHRYSLER		VT	C	2	12	GR	2	27 1/4	C		A	N	124735
									GR	2	27 1/4	C		A		
18 5/8	27 1/2	1 1/4	CHRYSLER		VT	C	2	12	GR	2 11/16	27 1/4	C		A	N	124677
									GR	2	27 1/4	C		A		
18 5/8	27 1/2	2	CHRYSLER		VT	C	3	12	FR	2 1/16	27 1/4	C		0	N	122626
									FR	2 1/16	27 1/4	C		0		
18 5/8	27 1/2	2	CHRYSLER		VT	C	3	12	GR	2 11/16	27 1/4	C		A	N	122618
									FR	2 1/16	27 1/4	C		A		
18 7/8	22	1 1/4	CHRYSLER		VT	C	2	12	BU	4	22 1/4	C		A	N	122342
									GR	2	22 3/4	C		A		
18 7/8	22	2	CHRYSLER		VT	C	3	12	BU	4	22 1/4	C		A	N	122250
									GR	2 1/4	21 3/4	C		A		
18 7/8	22	2	CHRYSLER		VT	C	3	12	BU	4	22 1/4	C		A	N	122252
									GR	2 1/2	21 7/8	C		A		
18 7/8	22	2	CHRYSLER		VT	C	3	12	BU	4	22 1/4	FF		A	N	122421
									GR	2 3/4	21 3/4	FF		A		
18 7/8	22	2 5/8	CHRYSLER		VT	C	4	12	BU	4	22 1/4	C		A	N	128601
									GR	2 13/16	21 7/16	C		A		
19 1/2	18 11/16	2	CHRYSLER		VT	C	3	12	GR	2 7/8	18 1/4	C		A	N	128471
									GR	2 1/8	18 1/2	C		A		
19 3/4	27 1/2	1 1/4	CHRYSLER		VT	C	2	12	GR	2 11/16	27 1/4	3/8		A	N	124939
									GR	2	27 1/4	C		A		
19 3/4	27 1/2	2	CHRYSLER		VT	C	3	12	GR	2 11/16	27 1/4	C		A	N	122621
									FR	2 1/16	27 1/4	C		A		
19 3/4	27 1/2	2	CHRYSLER		VT	C	3	14	GR	2 1/8	27 1/4	C		A	N	124821
									GR	2 1/8	27 1/4	C		A		
19 3/4	27 1/2	2	CHRYSLER		VT	C	3	16	GR	2 1/8	27 1/4	C		A	N	128529
									GR	2 1/8	27 1/4	C		A		
19 7/8	22 9/16	1 1/4	CHRYSLER		VT	C	2	12	BU	3 1/2	23 1/8	C		A	N	128461
									GR	2 1/4	22 5/8	C		A		
20	26 15/16	2	CHRYSLER		VT	C	3	14	GR	2 1/2	27 1/4	1/4		A	N	124974
									GR	2 1/2	27 1/4	1/4		A		
20 1/4	18 9/16	2 1/4	CHRYSLER INDUSTRIAL		T	C	3	8	GR	4 1/8	20	1/4		A	N	260710
									GR	4 1/8	20	1/4		A		
20 1/4	20 1/4	3	CHRYSLER INDUSTRIAL		T	C	4	8	GR	3 1/2	21 3/8	1/4		A	N	261493
									GR	3 1/2	21 3/8	1/4		A		
20 1/4	22	2	CHRYSLER		VT	C	3	12	BU	4	22 1/4	C		A	N	128665
									FR	2 1/8	21 3/4	C		A		
20 1/4	22	2 5/8	CHRYSLER		VT	C	4	12	BU	4	22 1/4	C		A	N	128657
									GR	2 3/4	21 3/4	C		A		
20 3/8	22	2	CHRYSLER		VT	C	3	12	BU	4	22 1/4	C		A	N	128467
									FR	2 1/4	21 1/2	C		A		
20 3/8	22	2	CHRYSLER		VT	C	3	12	BU	4	22 1/4	C		A	N	128537
									FR	2 1/8	21 1/2	C		A		
20 7/8	25 7/8	2	CHRYSLER		VT	C	3	12	GR	2 3/4	25 9/16	C		A	N	124778
									GR	2 3/4	25 9/16	C		A		

Vista-Pro Automotive - Core Catalog

(Cores Sorted by Application)

Height	Width	Depth	Application	Description	Fin Type	Fin Matl	Rows	FPI	BH / TH Type	BH / TH Width	BH / TH Length	BH / TH OHF	BH / TH Bolts	BH / TH Shape	Hdr Support	Part #
CHRYSLER (Cont)																
21	25 7/8	2 5/8	CHRYSLER		VT	C	4	12	GR GR	2 3/4 2 3/4	25 9/16 25 9/16	C C		A A	N	128668
21 1/8	18 11/16	1 1/4	CHRYSLER		VT	C	2	12	BU GR	4 1 3/4	19 1/4 18 1/2	C 1/8		A A	N	122453
21 1/4	22	1 1/4	CHRYSLER		VT	C	2	14	BU GR	4 2	22 1/4 21 3/4	C C		A A	N	128472
21 3/4	25 5/16	1 1/4	CHRYSLER		VT	C	2	12	GR GR	4 3 1/4	25 3/4 25 3/4	1/4 C		A A	N	124510
22	25 7/8	1 1/4	CHRYSLER		VT	C	2	12	GR GR	3 2	25 9/16 25 9/16	3/8 3/8		A A	N	124880
23 1/2	20 13/16	3	CHRYSLER INDUSTRIAL		T	C	4	9	GR GR	5 1/2 3	21 21	C C		A A	N	270155
CLETRAC																
20 1/4	20 1/4	3	CLETRAC	K12-20	T	C	4	6	BL BL	6 1/8 6 1/8	24 24	C C	26 26	J J	C	260595
23 3/4	20 1/4	3 3/4	CLETRAC	BD40, BGS	T	C	5	7	BL BL	6 1/8 6 1/8	24 24	C C	26 26	J J	C	260137
CLIMAX																
13 7/8	13 3/4	2 1/4	CLIMAX	C-46 CONDENSER HVY BTM HDR W/TANK & SIDES	X	C	3	7	SQ BH	2 3/4 4 1/2	13 7/8 15 3/4	C C	21	A A	C	221835
15 7/8	15 5/8	2 1/4	CLIMAX	C-66, C-96 CONDENSER HVY BTM HDR W/TANK & SIDES	X	C	3	7	SQ BH	2 7/8 4 1/2	15 3/4 17 3/4	C C	23	A A	C	221804
CONTINENTAL																
19	20	1 7/8	CONTINENTAL	LINCOLN WELDER	X	C	2	8	GR GR	3 1/8 2 1/4	19 3/4 19 3/4	3/16 3/16		A A	N	221343
19 3/4	19 1/8	2 1/4	CONTINENTAL	LINCOLN WELDER	T	C	3	8	GR GR	6 3 3/8	19 3/4 19 3/4	1/4 1/4		A A	N	261140
19 7/8	19 3/8	2 3/16	CONTINENTAL	LINCOLN WELDER	Z	C	3	9	GR GR	4 4	19 3/4 19 3/4	3/16 3/16		A A	N	225418
20 1/4	19 3/8	2 1/4	CONTINENTAL	CEMENT MIXER	X	C	3	8	GR GR	4 1/8 4 1/8	20 20	1/8 1/8		A A	N	270709
29 1/8	24 3/8	2 7/8	CONTINENTAL		S	C	5	8	GR GR	4 3/4 4 1/4	25 3/4 25 3/4	C C	0 0		C	266300
CRANE CARRIER																
26	25 7/8	4 1/2	CRANE CARRIER		T	C	6	8	BL BL	7 1/4 7 1/4	27 7/8 27 7/8	C C	42 42	A A	C	223084
26	26 1/4	2 7/8	CRANE CARRIER		R	C	5	8	BL BL	7 1/4 7 1/4	27 7/8 27 7/8	C C	42 42	A A	C	226400
35 1/16	29 3/8	2 3/8	CRANE CARRIER	HVY BTM HDR	R	C	4	9	BL BH	6 7/8 6 7/8	31 1/4 31 1/4	1 3/4 1 3/4	42 42	A A	C	226407
35 1/16	29 3/8	2 7/8	CRANE CARRIER		R	C	5	11	BL BL	10 3/8 6 7/8	31 1/4 31 1/4	2 7/16 1 3/4	54 42	F A	C	226123
35 1/16	29 3/8	3 7/16	CRANE CARRIER		R	C	6	11	BL BL	10 3/8 6 7/8	31 1/4 31 1/4	2 7/16 1 3/4	54 42	F A	C	226406
35 1/16	29 3/8	3 7/16	CRANE CARRIER	7 1/2" X 12" CRANK BOX	R	C	6	11	BL BL	10 3/8 6 7/8	31 1/4 31 1/4	2 7/16 1 3/4	54 42	F A	C	226839
35 1/4	29 3/8	3 7/16	CRANE CARRIER	7 1/2" X 12" CRANK BOX	R	C	6	11	BL BL	10 3/8 6 7/8	31 1/4 31 1/4	2 1/4 C	46 40	A A	C	226810
37 1/2	37 1/2	2 7/8	CRANE CARRIER	HVY T/BTM HDRS	R	C	5	11	BH BH	6 1/2 6 1/2	40 40	C C	48 48	A A	C	226409
37 1/2	37 1/2	3 7/16	CRANE CARRIER	HVY BTM HDR	S	C	6	9	BL BH	6 1/2 6 1/2	40 40	C C	48 48	A A	C	272825
40 7/8	29 3/8	3 7/16	CRANE CARRIER		R	C	6	11	BL BL	6 7/8 6 7/8	31 1/4 31 1/4	C C	42 42	A A	C	226410

Vista-Pro Automotive - Core Catalog

(Cores Sorted by Application)

Height	Width	Depth	Application	Description	Fin Type	Fin Matl	Rows	FPI	BH/TH Type	BH/TH Width	BH/TH Length	BH/TH OHF	BH/TH Bolts	BH/TH Shape	Hdr Support	Part #
CROWN COACH																
19	51 1/4	3 7/16	CROWN COACH		R	C	6	11	BL BL	6 1/4 6 1/4	51 9/16 51 9/16	C C		A A	N	226713
19 1/8	48 15/16	6	CROWN COACH		T	C	8	9	BL BL	8 3/8 8 3/8	52 52	C C	62 62	A A	C	223324
CUMMINS																
22	21 15/16	3	CUMMINS ENGINE		T	C	4	9	BL BL	5 3/8 5 3/8	24 24	C C	32 32	A A	C	272837
27 3/4	26 7/16	4 1/2	CUMMINS ENGINE	DRAGLINE HVY T/BTM HDRS	T	C	6	9	BH BH	7 3/8 7 3/8	29 1/2 29 1/2	C C	44 44	A A	C	272784
30	30	3 11/16	CUMMINS ENGINE	GE DIESEL HVY T/BTM HDRS	Z	C	5	11	BH BH	6 1/4 6 1/4	32 7/8 32 7/8	1 1/2 1 1/2	32 32	A A	C	225448
33	32 5/8	4 1/2	CUMMINS ENGINE	HVY BTM HDR	T	C	6	7	BL BH	7 3/8 7 3/8	35 35	C C	46 46	A A	C	277146
33 3/4	68 3/4	3 11/16	CUMMINS ENGINE	POWER UNIT HVY T/BTM HDRS 2 CORES PER RAD	Z	C	5	9	BH BH	11 5/8 9	71 3/4 71 3/4	1 7/8 1 7/8	84 80	A A	CC	225453
35	34 3/8	2 15/16	CUMMINS ENGINE	GROVE CRANE HVY T/BTM HDRS	Z	C	4	9	BH BH	7 3/4 7 3/4	36 36	1 5/8 1 5/8	48 48	A A	C	225435
36	32 1/2	3 11/16	CUMMINS ENGINE	NHR HVY BTM HDR	Z	C	5	8	BL BH	8 8	37 37	1 7/8 1 7/8	48 48	A A	C	225456
36	32 5/8	3 3/4	CUMMINS ENGINE	NHR HVY BTM HDR	T	C	5	8	BL BH	8 8	37 37	C C	48 48	A A	C	278904
36	32 5/8	4 1/2	CUMMINS ENGINE	NHR HVY BTM HDR	T	C	6	8	BL BH	8 8	37 37	C C	48 48	A A	C	277858
38	36 1/4	3 11/16	CUMMINS ENGINE	GEN SET	Z	C	5	11	BL BL	8 1/4 8 1/4	38 1/4 38 1/4	1 1/2 1 1/2	46 46	A A	C	225476
38 1/16	36	3	CUMMINS ENGINE	HVY T/BTM HDRS	T	C	4	8	BH BH	8 1/4 8 1/4	38 1/4 38 1/4	1 9/16 1 9/16	46 46	A A	C	272488
42	34 7/8	4 1/2	CUMMINS ENGINE	MH220 HVY T/BTM HDRS	T	C	6	9	BH BH	8 8	39 1/2 39 1/2	C C	50 50	A A	C	223085
42	35	4 7/16	CUMMINS ENGINE	MH220 HVY BTM HDR BRASS FINS	Z	B	6	11	BL BH	8 8	39 1/2 39 1/2	C C	50 50	A A	C	225487
42	42 3/16	4 1/2	CUMMINS ENGINE	350 DIESEL HVY T/BTM HDRS	T	C	6	9	BH BH	8 8	43 1/2 43 1/2	C C	54 54	A A	CC	272489
48	46 1/8	3	CUMMINS ENGINE	LOCOMOTIVE HVY T/BTM HDRS	T	C	4	9	BH BH	9 1/4 9 1/4	48 1/4 48 1/4	1 7/8 1 7/8	60 60	A A	CC	223086
48	46 1/8	4 1/2	CUMMINS ENGINE	1160	T	C	6	9	BH BH	9 1/4 9 1/4	48 1/4 48 1/4	1 7/8 1 7/8	60 60	A A	CC	272492
48	46 1/4	2 7/8	CUMMINS ENGINE	GEN SET 207481	R	C	5	10	BL BL	9 1/4 9 1/4	48 1/4 48 1/4	1 7/8 1 7/8	60 60	A A	CC	226466
48	46 1/4	4 7/16	CUMMINS ENGINE	600 CHIPPER HVY T/BTM HDRS BRASS FINS	Z	B	6	10	BH BH	9 1/4 9 1/4	48 1/4 48 1/4	1 7/8 1 7/8	60 60	A A	CC	225422
53 3/8	52 1/2	4 7/16	CUMMINS ENGINE	V-12 3001576 HVY BTM HDR BRASS FINS	Z	B	6	9	BL BH	10 1/4 10 1/4	55 3/8 55 3/8	2 2	64 64	A A	CC	225437
54	48 15/16	3 3/4	CUMMINS ENGINE	V-12 HVY T/BTM HDRS	T	C	5	8	BH BH	7 7	50 7/8 50 7/8	C C	62 62	A A	CC	272493
54	53 1/8	4 7/16	CUMMINS ENGINE	POWER UNIT HVY BTM HDR BRASS FINS	Z	B	6	10	BL BH	7 3/8 7 3/8	55 5/8 55 5/8	C C	64 64	A A	CC	225439
59 1/2	60	4 7/16	CUMMINS ENGINE	GENERATOR SET HVY T/BTM HDRS BRASS FINS	Z	B	6	9	BH BH	8 1/4 8 1/4	63 1/2 63 1/2	C C	74 74	A A	CC	225431
31 7/8	31 7/8	3 7/16	CUMMINS/DETROIT		R	C	6	11	BL BL	7 1/8 7 1/8	34 34	C C	40 40	A A	C	226853
33 1/4	31 7/8	3 7/16	CUMMINS/DETROIT		R	C	6	11	BL BL	7 1/8 7 1/8	34 34	C C	40 40	A A	C	226857

Vista-Pro Automotive - Core Catalog

(Cores Sorted by Application)

Height	Width	Depth	Application	Description	Fin Type	Fin Matl	Rows	FPI	BH / TH Type	BH / TH Width	BH / TH Length	BH / TH OHF	BH / TH Bolts	BH / TH Shape	Hdr Support	Part #
CUMMINS (Cont)																
36 1/4	36 1/4	3 7/16	CUMMINS/DETROIT		R	C	6	11	BL BL	7 1/8 7 1/8	39 39	C C	46 46	A A	C C	226854
38 1/4	36 1/4	3 7/16	CUMMINS/DETROIT		R	C	6	11	BL BL	7 1/8 7 1/8	39 39	C C	46 46	A A	C C	226858
42 1/2	42 1/2	3 7/16	CUMMINS/DETROIT		R	C	6	11	BL BL	7 1/8 7 1/8	45 45	C C	52 52	A A	CC CC	226855
48 1/8	48 1/8	3 7/16	CUMMINS/DETROIT		R	C	6	11	BH BH	7 1/8 7 1/8	51 51	C C	58 58	A A	CC CC	226856
DATSUN																
10 3/4	19 1/4	1 1/4	DATSUN		VT	C	2	14	BU GR	3 2 1/8	19 1/2 19 1/2	C C		A A	N N	124612
10 3/4	19 1/4	1 1/4	DATSUN		VT	C	2	12	BU GR	3 2	19 1/2 19 1/2	C C		A A	N N	128791
13	13 3/4	1 1/4	DATSUN		VT	C	2	12	GR GR	2 1/4 1 7/8	13 1/2 13 1/2	C C		A A	N N	124613
13	13 3/4	1 1/4	DATSUN		VT	C	2	12	GR GR	2 1/2 1 7/8	13 1/2 13 1/2	C C		A A	N N	124730
13	16 1/2	1 1/4	DATSUN		VT	C	2	12	GR GR	2 1/2 2	16 1/4 16 1/4	C C		A A	N N	128141
13	18 11/16	1 1/4	DATSUN		VT	C	2	12	GR GR	2 7/16 2 1/16	19 19	C C		A A	N N	124749
13	18 11/16	2	DATSUN		VT	C	3	12	GR GR	2 7/16 2 7/16	19 19	C C		A A	N N	124794
13	21 7/16	2	DATSUN		VT	C	3	14	GR GR	2 5/8 2 1/2	21 3/4 21 3/4	C C		A A	N N	124827
13 3/4	23 5/8	1 1/4	DATSUN		VT	C	2	14	GR GR	3 2 1/4	24 24	C 1		A A	N N	124604
13 3/4	23 5/8	2	DATSUN		VT	C	3	12	GR GR	3 3	24 24	C C		A A	N N	124706
13 3/4	23 5/8	2	DATSUN		VT	C	3	12	GR GR	3 2 1/2	24 24	C C		A A	N N	124941
14 1/8	24 3/16	2	DATSUN		VT	C	3	14	GR GR	2 7/16 2 7/16	24 1/2 24 1/2	C C		A A	N N	124912
14 1/4	21 7/16	1 1/4	DATSUN		VT	C	2	13	GR GR	2 3/4 2 1/16	21 3/4 21 3/4	C C		A A	N N	124728
16	24 3/16	2	DATSUN		VT	C	3	12	GR GR	2 5/8 2 7/16	24 1/2 24 1/2	C C		A A	N N	124779
16 1/8	24 3/16	2	DATSUN		VT	C	3	14	GR GR	2 5/8 2 5/8	24 5/8 24 5/8	C C		A A	N N	128808
16 7/8	25 5/16	1 1/4	DATSUN		VT	C	2	12	GR GR	2 1/2 2 1/2	25 5/8 25 5/8	C C		A A	N N	128154
26 3/8	13 3/16	1 1/4	DATSUN		VT	C	2	14	GR GR	1 15/16 2 5/8	13 1/8 13 1/8	C C		A A	N N	128283
DAVEY COMPRESSOR																
26 1/8	23 1/8	1 3/4	DAVEY COMPRESSOR	185 CFM COMPRESSOR C-63345	S	C	3	7	GR GR	3 3	23 15/16 23 15/16	C C		A A	C C	229040
DAVID BROWN TRACTOR																
16 1/4	14 3/8	2 3/16	DAVID BROWN TRACTOR		Z	C	3	9	GR GR	2 7/8 2 7/8	15 15	C C		A A	N N	289577
16 1/4	14 5/8	2 1/4	DAVID BROWN TRACTOR		T	C	3	8	GR GR	2 7/8 2 7/8	15 15	C C		A A	N N	278915
18 1/4	17 1/2	2 3/8	DAVID BROWN TRACTOR		R	C	4	7	GR GR	3 3	17 3/4 17 3/4	C C		A A	N N	226411

Vista-Pro Automotive - Core Catalog

(Cores Sorted by Application)

Height	Width	Depth	Application	Description	Fin Type	Fin Matl	Rows	FPI	BH/TH Type	BH/TH Width	BH/TH Length	BH/TH OHF	BH/TH Bolts	BH/TH Shape	Hdr Support	Part #
DETROIT DIESEL																
17 1/4	19 3/8	1 7/8	DETROIT DIESEL	2-71 PUMP	X	C	2	9	GR GR	3 3/8 3 3/8	19 3/4 19 3/4	3/16 3/16		A A	N	286528
19 3/8	19 1/8	2 1/4	DETROIT DIESEL		T	C	3	9	CR CR	4 3	19 1/2 19 1/2	C C		A A	N	223088
19 3/8	19 1/8	3	DETROIT DIESEL	COMPRESSOR	T	C	4	8	GR GR	4 1/4 4 1/4	19 7/8 19 7/8	1/8 1/8		A A	N	278976
19 1/2	19 3/8	2 1/4	DETROIT DIESEL	2-71 DIESEL	X	C	3	11		4 3	19 1/2 19 1/2	15/16 7/16		0 0	N	287224
20 1/4	18 9/16	3	DETROIT DIESEL	GENERATOR	T	C	4	8	BL BL	5 3/8 5 3/8	20 1/2 20 1/2	C C	34 34	A A	C	272642
24 3/4	21 7/8	2 3/8	DETROIT DIESEL	INGRAM ROLLER	S	C	4	10	BL BL	5 1/2 5 1/2	25 3/4 25 3/4	C C	38 38	A A	C	272883
24 7/8	21 15/16	3	DETROIT DIESEL	INGRAM ROLLER	T	C	4	8	BL BL	5 1/2 5 1/2	25 3/4 25 3/4	C C	38 38	A A	C	272884
24 7/8	24 3/4	2 1/4	DETROIT DIESEL		T	C	3	10	GR GR	4 3/4 4 3/4	25 1/2 25 1/2	C C		A A	C	223089
24 7/8	24 3/4	2 1/4	DETROIT DIESEL		T	C	3	10	GR GR	4 3/4 4 3/4	25 1/2 25 1/2	1/4 1/4		A A	C	223090
24 7/8	25	2 3/16	DETROIT DIESEL		Z	C	3	9	GR GR	4 4	25 7/8 25 7/8	1/2 1/2		A A	C	281616
25 1/8	25	2 1/4	DETROIT DIESEL	3-53 POWER UNIT	X	C	3	8	GR GR	4 4	25 3/4 25 3/4	1/4 1/4		0 0	C	221500
25 1/8	25	2 1/4	DETROIT DIESEL	4-53 ENGINE	X	C	3	8	GR GR	4 4	25 3/4 25 3/4	1/4 1/4		A A	C	221805
25 1/8	25 5/16	2 1/4	DETROIT DIESEL	3-53 ENGINE	T	C	3	8	GR GR	4 4	25 3/4 25 3/4	1/4 1/4		A A	C	223117
25 1/8	25 5/16	3	DETROIT DIESEL	3-53 ENGINE	T	C	4	8	GR GR	4 4	25 3/4 25 3/4	3/16 3/16		A A	C	223126
26 1/2	26 1/4	3	DETROIT DIESEL		X	C	4	8	GR GR	4 4	26 7/8 26 7/8	7/8 7/8		A A	C	288603
28 1/4	25 7/8	3 3/4	DETROIT DIESEL	6-71 DIESEL	T	C	5	10	GR GR	4 4	26 5/8 26 5/8	C C		A A	C	279145
29	25 5/8	2 15/16	DETROIT DIESEL	6V-71 ENGINE	Z	C	4	10	CR CR	5 1/4 4 1/4	25 7/8 25 7/8	5/8 5/8		A A	C	225413
29	25 5/8	3	DETROIT DIESEL	6V-71 ENGINE CRP/HDRS	X	C	4	8	CR CR	5 1/4 4 1/4	25 7/8 25 7/8	11/16 C		A A	C	221821
29	25 5/8	3 11/16	DETROIT DIESEL	6V-71 ENGINE	Z	C	5	11	CR CR	5 1/4 4 1/4	25 7/8 25 7/8	1/2 3/8		A A	C	225414
29	25 5/8	3 3/4	DETROIT DIESEL	6V-71 ENGINE	X	C	5	8	CR CR	5 1/4 4 1/4	25 7/8 25 7/8	1/2 C		A A	C	221511
29	25 5/8	3 3/4	DETROIT DIESEL	6V-71 ENGINE	X	C	5	8	CR CR	7 1/4 4 1/4	17 3/4 25 7/8	3/8 5/16		A A	C	281257
29	25 7/8	3	DETROIT DIESEL	6V-71 ENGINE	T	C	4	8	CR CR	5 1/4 4 1/4	26 26	11/16 C		A A	C	223091
29	25 7/8	3 3/4	DETROIT DIESEL	6V-71 ENGINE	T	C	5	8	CR CR	5 1/4 4 1/4	25 7/8 25 7/8	9/16 C		A A	C	223092
30	29 1/4	3	DETROIT DIESEL	6V-71 ENGINE	T	C	4	10	GR GR	4 7/8 4 7/8	29 3/4 29 3/4	3/16 3/16		A A	C	223093
30 1/2	26 1/4	3 3/4	DETROIT DIESEL	6V-71 DIESEL	X	C	5	8	BL BL	7 1/2 7 1/2	31 3/8 31 3/8	1 3/16 1 3/16	32 32	LL LL	C	280180
30 1/2	26 7/16	3 3/4	DETROIT DIESEL	6V-71 DIESEL	T	C	5	7	BL BL	7 1/2 7 1/2	31 3/8 31 3/8	1 3/16 1 3/16	32 32	B B	C	270200
31 7/8	43 7/8	3 3/4	DETROIT DIESEL	12V-71 HVY T/BTM HDRS	T	C	5	10	BH BH	8 8	46 3/4 46 3/4	C C	54 54	A A	CC	223095

Vista-Pro Automotive - Core Catalog

(Cores Sorted by Application)

Height	Width	Depth	Application	Description	Fln Type	Fln Matl	Rows	FPI	BH/TH Type	BH/TH Width	BH/TH Length	BH/TH OHF	BH/TH Bolts	BH/TH Shape	Hdr Support	Part #
DETROIT DIESEL (Cont)																
34 1/4	34 5/16	4 1/2	DETROIT DIESEL	DOWELL DRILL W/6V-71 HVY T/BTM HDRS	T	C	6	9	BH BH	7 5/8 7 5/8	36 36	C C	58 58	A A	C	223096
35	34 5/16	4 1/2	DETROIT DIESEL	HVY BTM HDR	T	C	6	9	BL BH	8 8	36 1/2 36 1/2	C C	50 50	A A	C	278977
36	33 3/16	3 3/4	DETROIT DIESEL	HVY T/BTM HDRS	T	C	5	9	BH BH	8 3/8 8 3/8	36 36	C C	50 50	A A	C	272877
36 1/8	25 5/16	3 3/4	DETROIT DIESEL	6V-71	T	C	5	8	BL BL	7 1/8 7 1/8	28 28	C C	40 40	A A	C	270646
36 1/8	25 5/16	4 1/2	DETROIT DIESEL	TWIN DIESEL	T	C	6	8	BL BL	8 1/8 8 1/8	28 28	C C	40 40	A A	C	270199
36 1/8	25 5/16	5 1/4	DETROIT DIESEL		T	C	7	7	BL SQ	8 1/8 8 1/8	28 28	C C	38 38	A A	C	270093
36 1/8	25 5/8	3 3/4	DETROIT DIESEL	TWIN DIESEL	X	C	5	8	BL BL	7 1/8 7 1/8	28 28	1 13/16 1 13/16	40 40	A A	C	282153
38	33 1/2	6	DETROIT DIESEL	DRILL ENGINE HVY T/BTM HDRS	B	C	8	6	BH BH	8 1/2 8 1/2	35 3/4 35 3/4	C C	46 46	A A	C	272869
38	38 1/4	4 1/2	DETROIT DIESEL	HVY BTM HDR	T	C	6	9	BL BH	7 3/8 7 3/8	40 40	C C	48 48	A A	C	265375
39 1/8	33 3/4	3 3/4	DETROIT DIESEL	HVY T/BTM HDRS	T	C	5	9	BH BH	8 8	35 35	C C	46 46	A A	C	272876
39 1/4	32 5/8	4 1/2	DETROIT DIESEL	8V-71 HVY BTM HDR	T	C	6	9	BL BH	7 1/4 7 1/4	35 35	C C	46 46	A A	C	272845
39 1/4	33 3/4	3	DETROIT DIESEL	8V-71 HVY BTM HDR 7/8" BTWN HOLES 4 & 5	T	C	4	9	BL BH	7 3/8 7 3/8	37 1/2 37 1/2	C C	46 46	B B	C	223601
39 1/4	33 3/4	3 3/4	DETROIT DIESEL	HVY BTM HDR 1 3/4" BTWN HOLES 4 & 5	T	C	5	9	BL BH	7 3/8 7 3/8	37 1/2 37 1/2	C C	46 46	B B	C	223600
39 1/4	33 3/4	3 3/4	DETROIT DIESEL	8V-71 HVY BTM HDR 2" BTWN HOLES 4 & 5	T	C	5	8	BL BH	7 3/8 7 3/8	37 1/2 37 1/2	C C	46 46	B B	C	223610
39 1/4	33 3/4	3 3/4	DETROIT DIESEL	8V-71 HVY BTM HDR 7/8" BTWN HOLES 4 & 5	T	C	5	9	BL BH	7 5/16 7 5/16	37 1/2 37 1/2	C C	46 46	B B	C	223618
39 1/4	33 3/4	4 1/2	DETROIT DIESEL	8V-71 HVY BTM HDR 7/8" BTWN HOLES 4 & 5	T	C	6	8	BL BH	7 5/16 7 5/16	37 9/16 37 9/16	C C	46 46	B B	C	223118
39 1/4	36	4 1/2	DETROIT DIESEL	HVY T/BTM HDRS	T	C	6	8	BH BH	7 3/8 7 3/8	39 1/4 39 1/4	C C	52 52	A A	C	272648
39 3/8	33 3/4	3 11/16	DETROIT DIESEL	6-110 HVY BTM HDR 7/8" BTWN HOLES 4 & 5	Z	C	5	10	BL BH	7 3/8 7 3/8	37 1/2 37 1/2	1 1/2 1 1/2	46 46	B B	C	225514
39 3/8	33 3/4	4 5/8	DETROIT DIESEL	HVY BTM HDR	X	C	6	9	BL BH	7 3/8 7 3/8	37 1/2 37 1/2	C C	46 46	B B	C	221516
39 1/2	33 3/4	4 7/16	DETROIT DIESEL	8V-71 DIESEL HVY BTM HDR BRASS FINS 2" BTWN HOLES 4 & 5	Z	B	6	7	BL BH	7 1/2 7 1/2	37 1/2 37 1/2	1 1/2 1 1/2	46 46	B B	C	225524
39 1/2	33 3/4	4 1/2	DETROIT DIESEL	6-110 HVY BTM HDR 2" BTWN HOLES 4 & 5	T	C	6	8	BL BH	7 1/2 7 1/2	37 1/2 37 1/2	C C	46 46	B B	C	223617
41 5/8	41 1/4	4 7/16	DETROIT DIESEL	V-12 1783-7200 HVY T/BTM HDRS BRASS FINS	Z	B	6	9	BH BH	8 3/4 8 3/4	43 5/8 43 5/8	C C	54 54	A A	CC	288472
41 5/8	41 5/8	3 3/4	DETROIT DIESEL	HVY BTM HDR	T	C	5	8	BL BH	8 3/4 8 3/4	43 5/8 43 5/8	C C	54 54	A A	CC	275463
41 5/8	41 5/8	4 1/2	DETROIT DIESEL	12V-71 HVY BTM HDR	T	C	6	8	BL BH	8 3/4 8 3/4	43 5/8 43 5/8	C C	54 54	A A	CC	223124
41 3/4	40 1/2	4 1/2	DETROIT DIESEL	HVY T/BTM HDRS	T	C	6	8	BH BH	8 8	43 5/8 43 5/8	C C	54 54	A A	CC	272865
42	34 7/8	4 1/2	DETROIT DIESEL		T	C	6	8	BL BL	8 8	39 5/8 39 5/8	C C	50 50	A A	C	272651

Vista-Pro Automotive - Core Catalog

(Cores Sorted by Application)

Height	Width	Depth	Application	Description	Fin Type	Fin Matl	Rows	FPI	BH / TH Type	BH / TH Width	BH / TH Length	BH / TH OHF	BH / TH Bolts	BH / TH Shape	Hdr Support	Part #
DETROIT DIESEL (Cont)																
42	41 5/8	3 3/4	DETROIT DIESEL	HVY T/BTM HDRS	T	C	5	8	BH BH	8 3/4 8 3/4	43 3/4 43 3/4	C C	54 54	A A	CC	272652
42 1/2	42 1/2	3 7/16	DETROIT DIESEL	HVY T/BTM HDRS	S	C	6	11	BH BH	7 1/4 7 1/4	45 45	C C	52 52	A A	CC	272875
44	41 5/8	4 1/2	DETROIT DIESEL	HVY T/BTM HDRS	T	C	6	8	BH BH	8 8	42 42	C C	48 48	A A	CC	272653
45	46 7/8	2 7/8	DETROIT DIESEL	GEN SET FULL REINF T/HDR HVY BTM HDR	R	C	5	11	BL BH	9 9	49 1/8 49 1/8	C C	56 56	F 0	CC	226848
48	48 3/8	5 1/4	DETROIT DIESEL	DRILL ENGINE HVY T/BTM HDRS	T	C	7	9	BH BH	8 3/4 8 3/4	50 1/2 50 1/2	C C	58 58	A A	CC	272867
50	50	4 7/16	DETROIT DIESEL	HVY T/BTM HDRS BRASS FINS	Z	B	6	9	BH BH	9 1/8 9 1/8	52 5/8 52 5/8	2 1/2 2 1/2	66 66	A A	CC	281651
50	50 1/16	3 3/4	DETROIT DIESEL	HVY T/BTM HDRS	T	C	5	8	BH BH	9 1/8 9 1/8	52 1/2 52 1/2	2 3/8 2 3/8	66 66	A A	CC	272655
50	50 1/16	4 1/2	DETROIT DIESEL	HVY T/BTM HDRS	T	C	6	8	BH BH	9 1/4 9 1/4	52 1/4 52 1/4	C C	62 62	A A	CC	223097
50	50 1/16	4 1/2	DETROIT DIESEL	V-16 HVY T/BTM HDRS	T	C	6	8	BH BH	9 1/8 9 1/8	52 1/2 52 1/2	C C	66 66	A A	CC	272656
50	50 1/16	4 1/2	DETROIT DIESEL	HVY T/BTM HDRS 4 CRNRS OF CORE NOTCHED	T	C	6	8	BH BH	8 8	50 50	C C	56 56	A A	CC	272871
60	53 3/4	4 7/16	DETROIT DIESEL	HVY T/BTM HDRS BRASS FINS	Z	B	6	9	BH BH	8 1/4 8 1/4	56 1/2 56 1/2	2 2	66 66	A A	CC	225536
60	61 1/4	4 7/16	DETROIT DIESEL	HVY BTM HDR BRASS FINS 4 CRNRS OF CORE NOTCHED	Z	B	6	8	BL BH	8 8	62 62	1 3/4 1 3/4	68 68	A A	CC	286554
DIAMOND REO																
32	26 1/4	2 7/8	DIAMOND REO		R	C	5	11	GR GR	8 1/4 4	26 7/8 26 7/8	3/8 3/8		A A	C	226418
40 1/2	29 3/8	2 3/8	DIAMOND REO	C-116 HVY BTM HDR TEMPLATE #3	R	C	4	9	BL BH	10 3/8 6	31 1/4 31 1/4	2 7/8 C	54 42	B B	C	226429
DIEHOE																
21	23 1/8	3 3/4	DIEHOE		X	C	5	10	GR GR	4 4	23 7/8 23 7/8	C C		A A	N	266329
DIVCO																
20 1/8	19 3/8	2 3/8	DIVCO	240, 300 C528175	R	C	4	8		3 1/4 3 1/4	19 7/8 19 7/8	1/2 1/2		0 0	N	226129
DODGE																
15 7/8	30 1/8	1 9/16	DODGE TRK	WITH DIESEL	VE	C	3	17	GR GR	1 7/8 1 7/8	30 7/8 30 7/8	C C		A A	N	128853
17 7/8	18 11/16	1 1/4	DODGE		VT	C	2	12	GR GR	2 7/8 2	18 1/4 18 1/2	1/4 1/8		A A	N	124547
17 7/8	22	1 1/4	DODGE		VT	C	2	13	GR GR	3 3/8 2	21 5/8 21 3/4	FR C		A A	N	124539
17 7/8	22	2	DODGE		VT	C	3	12	GR FR	3 3/8 2 1/8	21 5/8 21 3/4	FF FR		A A	N	128633
18	15 3/8	1 1/4	DODGE	PLYMOUTH	VT	C	2	16	GR GR	1 3/4 1 3/4	16 3/8 16 3/8	C C		A A	N	122460
18	18 11/16	1 1/4	DODGE		VT	C	2	12	BU GR	4 1 3/4	19 1/4 18 1/2	C C		A A	N	122352
18	19 1/4	1 1/4	DODGE	PLYMOUTH	VT	C	2	12	BU GR	4 1 3/4	19 1/4 19	C C		A A	N	122327
18	22	1 1/4	DODGE		VT	C	2	12	GR GR	1 3/4 1 3/4	22 5/16 22 5/16	C C		A A	N	122407
18	25 7/8	1 1/4	DODGE		VT	C	2	14	GR GR	3 2 3/4	25 9/16 25 9/16	3/8 3/8		A A	N	124591

Vista-Pro Automotive - Core Catalog

(Cores Sorted by Application)

Height	Width	Depth	Application	Description	Fin Type	Fin Matl	Rows	FPI	BH/TH Type	BH/TH Width	BH/TH Length	BH/TH OHF	BH/TH Bolts	BH/TH Shape	Hdr Support	Part #
DODGE (Cont)																
18	25 7/8	1 1/4	DODGE		VT	C	2	15	GR	3	25 9/16	3/8		A	N	124636
									GR	2	25 9/16	C		A		
18 1/8	22	2	DODGE		VT	C	3	12	BU	4	22 1/4	C		A	N	122231
									GR	2 1/2	21 7/8	C		A		
18 3/16	25 5/16	1 1/4	DODGE	ASPEN	VT	C	2	16	GR	1 15/16	26 1/4	C		A	N	128723
									GR	1 15/16	26 1/4	C		A		
18 1/4	21 1/4	2 7/8	DODGE	LIGHT TRUCK	S	C	5	10	CR	7 1/4	17 3/4	3/8		A	N	266331
									CR	3 5/8	21 1/2	3/8		A		
18 3/8	18 11/16	1 1/4	DODGE	DART	VT	C	2	12	GR	2 7/8	18 1/4	3/16		A	N	124638
									GR	1 3/4	18 1/2	3/16		A		
18 3/8	22	1 1/4	DODGE		VT	C	2	12	GR	2 3/4	21 5/8	1/4		A	N	124693
									GR	2	21 5/8	C		A		
18 3/8	25 7/8	2	DODGE TRK		VT	C	3	12	GR	3	25 9/16	C		A	N	124516
									GR	2 3/4	25 9/16	C		A		
18 5/8	27 1/2	1 1/4	DODGE		VT	C	2	16	GR	2 11/16	27 1/4	3/16		A	N	124996
									GR	2	27 1/4	3/16		A		
18 5/8	27 1/2	2	DODGE		VT	C	3	12	GR	2 11/16	27 1/4	C		A	N	124678
									GR	2 11/16	27 1/4	C		A		
18 3/4	21 3/8	3	DODGE TRK	ARMY TRUCK CRP/HDRS	T	C	4	9	CR	6 3/8	21 1/2	1/2		A	N	270185
									CR	3 5/8	21 1/2	1/2		A		
18 3/4	27 11/16	1 9/16	DODGE TRK		VE	C	3	16	GR	2	27 1/4	C		A	N	128852
									GR	2	27 1/4	C		A		
19 1/2	18 11/16	1 1/4	DODGE TRK		VT	C	2	12	GR	2 7/8	18 1/4	1/4		A	N	124521
									GR	1 3/4	18 1/2	1/8		A		
20 1/4	22	1 1/4	DODGE		VT	C	2	12	BU	4	22 1/4	C		A	N	122396
									GR	2	21 3/4	C		A		
20 1/4	22	1 1/4	DODGE		VT	C	2	12	BU	4	22 1/4	1/4		A	N	122506
									GR	2	21 3/4	1/4		A		
20 1/4	22	2	DODGE		VT	C	3	12	BU	4	22 1/4	C		A	N	124590
									GR	2 3/4	21 3/4	C		A		
21	18 11/16	2	DODGE TRK		VT	C	3	12	BU	4	19 1/4	C		A	N	128470
									FR	2 1/8	18 1/2	C		A		
21	19 1/4	1 1/4	DODGE TRK		VT	C	2	12	BU	4	19 1/4	C		A	N	124660
									GR	1 3/4	19	C		A		
21	25 7/8	2	DODGE	PICKUP	VT	C	3	14	GR	2 3/4	25 9/16	C		A	N	128282
									GR	2 3/4	25 9/16	C		A		
21 5/8	25	1 3/4	DODGE TRK	D400-600	R	C	3	11	GR	4	25 3/4	3/4		A	N	226433
									GR	3 1/8	25 3/4	C		A		
21 3/4	25	1 7/8	DODGE TRK	500W	X	C	2	11	GR	5	25 3/4	1 3/8		A	N	288874
									GR	3	25 3/4	3/8		A		
21 3/4	25	2 3/8	DODGE TRK	D500-600	R	C	4	10	GR	4	25 3/4	1/2		A	N	226434
									GR	3	25 3/4	C		A		
21 3/4	25	2 3/8	DODGE TRK	D500-700	R	C	4	11	GR	5	25 3/4	C		A	N	226435
									GR	3	25 3/4	C		A		
21 3/4	25 5/16	2	DODGE TRK		VT	C	3	14	GR	5	25 3/4	1 1/8		A	N	124513
									GR	3	25 3/4	1/4		A		
21 3/4	25 5/16	2	DODGE TRK		VT	C	3	12	GR	4	25 3/4	1/4		A	N	128465
									GR	3	25 3/4	1/4		A		
21 3/4	25 5/16	2	DODGE TRK		VT	C	3	14	GR	5	25 3/4	C		A	N	128652
									GR	3	25 3/4	C		A		
21 3/4	25 5/16	2 5/8	DODGE TRK		VT	C	4	12	GR	5	25 3/4	C		A	N	128658
									GR	3	25 3/4	C		A		
21 3/4	25 5/16	1 1/2	DODGE TRK	D400-600	T	C	2	10	GR	4	25 3/4	3/4		A	N	223101
									GR	3	25 3/4	C		A		

Vista-Pro Automotive - Core Catalog

(Cores Sorted by Application)

Height	Width	Depth	Application	Description	Fin Type	Fin Matl	Rows	FPI	BH/TH Type	BH/TH Width	BH/TH Length	BH/TH OHF	BH/TH Bolts	BH/TH Shape	Hdr Support	Part #
DODGE (Cont)																
21 3/4	25 5/16	2 1/4	DODGE TRK	D400-600	T	C	3	10	GR	4	25 3/4	3/4		A	N	263308
									GR	3	25 3/4	C		A		
21 7/8	25 5/16	2	DODGE TRK		VT	C	3	12	GR	3 1/4	25 5/8	C		A	N	122635
									GR	3 1/4	25 5/8	C		A		
22	22	2	DODGE TRK		VT	C	3	12	BU	4	22 5/16	C		A	N	122648
									GR	2 1/2	21 5/8	C		A		
22	22	2	DODGE TRK		VT	C	3	12	BU	4	22 5/16	C		A	N	122705
									GR	2 1/2	21 5/8	C		A		
22	25 5/8	2 3/8	DODGE TRK		R	C	4	11	GR	3	25 5/8	C		A	N	226131
									GR	2 3/4	25 5/8	C		A		
22	25 7/8	2	DODGE		VT	C	3	12	GR	3	25 9/16	C		A	N	124717
									GR	2 3/4	25 9/16	C		A		
22 1/4	25 5/16	1 1/4	DODGE TRK		VT	C	2	12	GR	3	25 5/8	1		A	N	122651
									GR	2 3/4	25 5/8	1		A		
23 3/4	25 7/8	2	DODGE		VT	C	3	15	GR	3	25 9/16	C		A	N	124923
									GR	2 3/4	25 9/16	C		A		
25 3/8	25 5/16	2 1/4	DODGE TRK	800 DIESEL	T	C	3	9	GR	5	25 3/4	C		A	C	223102
									GR	3	25 3/4	C		A		
25 3/8	25 5/8	1 3/4	DODGE TRK	CT700-1000	R	C	3	11	GR	5	25 3/4	C		A	C	226437
									GR	3	25 3/4	C		A		
25 5/8	25 5/16	2 1/4	DODGE TRK	C800-900, D800	T	C	3	10	GR	4	25 3/4	3/8		A	C	262977
									GR	3	25 3/4	C		A		
25 5/8	25 5/16	3	DODGE TRK		T	C	4	11	GR	3 1/4	25 5/8	C		A	C	223104
									GR	3 1/4	25 5/8	C		A		
33	26 1/4	2 3/8	DODGE TRK	D1000	R	C	4	11	BL	10	28 3/4	1 1/2	42	A	C	226134
									BL	5 1/4	28 3/4	1 1/2	38	A		
DRESSER INDUSTRIES																
19 3/4	19 3/8	2 1/4	DRESSER INDUSTRIES	HOUGH H25-B	X	C	3	9	GR	4	19 3/4	1/4		A	N	221501
									GR	4	19 3/4	1/4		A		
20 1/8	21 3/8	3	DRESSER INDUSTRIES	TD-6	T	C	4	7	BL	5 1/2	24 3/8	C	22	A	C	223022
									BL	5 1/2	24 3/8	C	22	A		
21	20 13/16	3	DRESSER INDUSTRIES	HOUGH	T	C	4	10	GR	3 1/2	22	C		A	N	262966
									GR	3 1/2	22	C		A		
22 1/2	27 1/2	2 7/8	DRESSER INDUSTRIES	1260643-H1	S	C	5	7	GR	4 1/4	28 1/4	C		A	N	229042
									GR	4 1/4	28 1/4	C		A		
22 7/8	25	2 7/8	DRESSER INDUSTRIES	515B LOADER 1279581-H91	S	C	5	7	GR	4 5/16	25 3/4	C		A	N	229128
									GR	4 5/16	25 3/4	C		A		
23 3/4	21 1/4	3	DRESSER INDUSTRIES	TD-6	X	C	4	7	BL	5 1/2	24 3/8	C	23	A	C	270925
									BL	5 1/2	24 3/8	C	23	A		
23 3/4	22 1/2	3	DRESSER INDUSTRIES	TD-9	X	C	4	7	BL	5 1/2	25 3/4	C	23	F	C	274400
									BL	5 1/2	25 3/4	C	23	F		
23 15/16	20 5/8	4 7/16	DRESSER INDUSTRIES	TD-7 1248995-H91 744043-C1	S	C	8	9	GR	5 7/8	21 15/16	5/8		A	N	229043
									GR	5 7/8	21 15/16	5/8		A		
24	22 1/2	3	DRESSER INDUSTRIES	WD-9	X	C	4	7	BL	5 7/8	24 3/8	1 1/4	30	A	C	221828
									BL	5 7/8	24 3/8	1 1/4	30	A		
24	22 1/2	3 3/4	DRESSER INDUSTRIES	WD-9	T	C	5	6	BL	5 7/8	24 3/8	C	30	A	C	261746
									BL	5 7/8	24 3/8	C	30	A		
24 1/2	28 3/4	2 15/16	DRESSER INDUSTRIES	TD-14 HVY BTM HDR	Z	C	4	10	BL	5 1/2	32	1 1/4	29	A	C	287188
									BH	5 1/2	32	1 1/4	28	A		
24 1/2	28 3/4	3	DRESSER INDUSTRIES	TD-14 HVY BTM HDR	X	C	4	7	BL	5 1/2	32	C	29	A	C	274402
									BH	5 1/2	32	C	29	A		
27 5/8	25 5/16	3	DRESSER INDUSTRIES	HOUGH H-70 LOADER	T	C	4	7	GR	4 5/8	25 3/4	3/8		A	C	265854
									GR	4 5/8	25 3/4	3/8		A		

Vista-Pro Automotive - Core Catalog

(Cores Sorted by Application)

Height	Width	Depth	Application	Description	Fin Type	Fin Matl	Rows	FPI	BH / TH Type	BH / TH Width	BH / TH Length	BH / TH OHF	BH / TH Bolts	BH / TH Shape	Hdr Support	Part #
DRESSER INDUSTRIES (Cont)																
27 3/4	20 5/8	4 7/16	DRESSER INDUSTRIES	TD-8C 653856-C91, 630266-C1 HVY T/BTM HDRS BRASS FINS	Z	B	6	10	BH	8	22 1/4	1 1/2	34	A	C	285099
									BH	7 3/8	22 1/4	1 1/2	34	A		
29	25 5/8	2 7/8	DRESSER INDUSTRIES	HOUGH PAYLOADER	S	C	5	9	GR	5 1/4	25 3/4	C		A	C	266075
									GR	4 1/2	25 3/4	C		A		
29 1/4	27 1/2	2 7/8	DRESSER INDUSTRIES	520B LOADER 1279582-H91	S	C	5	7	GR	4 3/4	28 1/4	C		A	C	229129
									GR	4 3/4	28 1/4	C		A		
29 5/8	31 7/8	4 7/16	DRESSER INDUSTRIES	TD-15 630717-C1 BRASS FINS	Z	B	6	8	BL	9 3/8	34 1/4	C	38	A	C	225183
									GR	5 3/4	32 1/4	C		A		
29 5/8	31 7/8	4 7/16	DRESSER INDUSTRIES	TD-15 630717-C1 HVY STEEL FINS	Z	S	6	8	BL	9 3/8	34 1/4	C	38	A	C	225939
									GR	5 3/4	32 1/4	C		A		
29 5/8	32	5 1/4	DRESSER INDUSTRIES	TD-15B HVY T/HDR BRASS FINS FACE DIPPED	B	B	7	6	BH	9 3/8	34 1/4	2	38	A	C	275226
									GR	5 3/4	32 1/4	1/2		A		
29 5/8	32 1/16	4 1/2	DRESSER INDUSTRIES	TD-15B HVY T/BTM HDRS BRASS FINS FACE DIPPED	T	B	6	7	BH	9 3/8	34 1/4	2	38	A	C	272697
									GR	5 3/4	32 1/4	1/2		A		
32	31 1/2	3 3/4	DRESSER INDUSTRIES	HOUGH H-90 HVY BTM HDR	T	C	5	7	BL	8 5/8	34	1 3/4	44	A	C	223587
									BH	8 5/8	34	1 3/4	44	A		
32 1/4	26 7/8	3 11/16	DRESSER INDUSTRIES	175 LOADER BRASS FINS	Z	B	5	8	BL	9 3/8	29 1/2	2	34	A	C	285062
									GR	5 3/4	27	3/16		A		
32 1/4	27	4 1/2	DRESSER INDUSTRIES	175B LOADER	T	C	6	8	BL	9 3/8	29 1/2	2	34	A	C	265439
									GR	5 3/4	27	3/8		A		
32 1/4	27	4 1/2	DRESSER INDUSTRIES	175B LOADER BRASS FINS FACE DIPPED	B	B	6	6	BL	9 3/8	29 1/2	2 1/8	34	A	C	277065
									GR	5 5/8	27	1/4		A		
37 1/8	37 1/2	5 3/16	DRESSER INDUSTRIES	TD-20 HVY T/BTM HDRS BRASS FINS	Z	B	7	6	BH	8 1/8	39 5/8	C	50	A	C	225643
									BH	8 1/8	39 5/8	C	50	A		
37 3/16	32	5 1/4	DRESSER INDUSTRIES	250-C LOADER HVY T/BTM HDRS BRASS FINS FACE DIPPED	B	B	7	7	BH	9 7/16	34 1/4	1 5/8	46	A	C	229550
									BH	9 7/16	34 1/4	1 5/8	46	A		
37 1/4	37 1/2	4 7/16	DRESSER INDUSTRIES	TD-20C 630458C1 HVY T/BTM HDRS BRASS FINS	Z	B	6	8	BH	9 1/2	39 5/8	1 3/4	52	A	C	286497
									BH	9 1/2	39 5/8	1 3/4	52	A		
39 5/8	41 1/4	6	DRESSER INDUSTRIES	TD-25C HVY T/BTM HDRS HVY STEEL FINS 7/8" BTWN HOLES 5 & 6	Z	S	8	8	BH	9 3/8	44 1/2	1 9/16	66	A	CC	225921
									BH	9 3/8	44 1/2	1 9/16	66	A		
39 5/8	41 1/2	6	DRESSER INDUSTRIES	TD-25C CRAWLER HVY T/BTM HDRS 7/8" BTWN HOLES 5 & 6	B	C	8	7	BH	9 3/8	44 1/2	C	66	A	CC	279334
									BH	9 3/8	44 1/2	C	66	A		
39 5/8	41 7/8	6	DRESSER INDUSTRIES	TD-25C 630463-C2 HVY T/BTM HDRS BRASS FINS	Z	B	8	9	BH	9 3/8	44 1/2	C	66	A	CC	225218
									BH	9 3/8	44 1/2	C	66	A		
39 5/8	41 7/8	6	DRESSER INDUSTRIES	TD-25C 630463-C2 HVY T/BTM HDRS HVY STEEL FINS	Z	S	8	9	BH	9 3/8	44 1/2	C	66	A	CC	225813
									BH	9 3/8	44 1/2	C	66	A		
40 3/16	36 7/8	3 11/16	DRESSER INDUSTRIES	HVY T/BTM HDRS BRASS FINS	Z	B	5	6	BH	7 1/4	39 1/4	C	50	A	C	285216
									BH	7 1/4	39 1/4	C	50	A		
42	36 1/4	6	DRESSER INDUSTRIES	TD-20 1209720-H91 HVY T/BTM HDRS HVY STEEL FINS	Z	S	8	7	BH	9	39 1/16	C	50	A	C	225950
									BH	9	39 1/16	C	50	A		
43	36 1/4	6	DRESSER INDUSTRIES	TD-20 HVY T/BTM HDRS BRASS FINS	Z	B	8	7	BH	9	39 1/16	C	50	A	C	225624
									BH	9	39 1/16	C	50	A		
43	36 1/4	6	DRESSER INDUSTRIES	TD-20 719806-C1 HVY T/BTM HDRS HVY STEEL FINS	Z	S	8	7	BH	9	39 1/16	C	50	A	C	225963
									BH	9	39 1/16	C	50	A		
47 7/8	40 1/2	4 1/2	DRESSER INDUSTRIES	HOUGH 560 HVY T/BTM HDRS	B	C	6	8	BH	8 1/2	42 1/2	C	54	A	CC	279339
									BH	8 1/2	42 1/2	C	54	A		
DROTT																
19 1/2	23 1/8	3 3/4	DROTT	BACKHOE	X	C	5	8	SQ	4	23 3/4	C		A	N	289956
									SQ	4	23 3/4	C		A		
25 1/4	25 5/8	3 11/16	DROTT	1800 CRANE	Z	C	5	11	GR	4	27	C		A	C	225516
									GR	4	27	C		A		

Vista-Pro Automotive - Core Catalog

(Cores Sorted by Application)

Height	Width	Depth	Application	Description	Fin Type	Fin Matl	Rows	FPI	BH/TH Type	BH/TH Width	BH/TH Length	BH/TH OHF	BH/TH Bolts	BH/TH Shape	Hdr Support	Part #
DYNAHOE																
21 1/8	23 1/8	3 3/4	DYNAHOE		X	C	5	8	GR GR	4 4	23 7/8 23 7/8	C C		A A	N	289594
22 1/4	23 1/8	3 11/16	DYNAHOE	190-4	Z	C	5	9	SQ SQ	4 5/16 4 5/16	23 3/4 23 3/4	C C		A A	N	281648
EAGLE COACH																
32	37 1/2	4 7/16	EAGLE COACH	BUS HVY BTM HDR BRASS FINS	Z	B	6	9	BL BH	7 3/8 7 3/8	41 41	C C	52 52	A A	C	288420
32	37 11/16	3 3/4	EAGLE COACH	HVY BTM HDR	T	C	5	9	BL BH	7 3/8 7 3/8	41 41	C C	52 52	A A	C	272416
32	37 11/16	4 1/2	EAGLE COACH	HVY BTM HDR	T	C	6	9	BL BH	7 3/8 7 3/8	41 41	C C	52 52	A A	C	223625
ELGIN																
18 1/2	19 1/8	3	ELGIN	SWEEPER	T	C	4	8	GR GR	4 4	19 3/4 19 3/4	1/4 1/4		A A	N	223589
18 1/2	19 3/8	2 15/16	ELGIN	3D-264	Z	C	4	10	GR GR	4 4	19 3/4 19 3/4	C C		A A	N	288582
EMD LOCOMOTIVE																
26 7/16	31 7/8	3 11/16	EMD LOCOMOTIVE	3129239 HVY T/BTM HDRS RECESSED HDRS	T12	C	4	9	PN PN	6 7/8 6 7/8	35 3/4 35 3/4	C C	40 40	A A	N	225425
26 9/16	29 3/8	5 3/16	EMD LOCOMOTIVE	3129131 HVY T/BTM HDRS RECESSED BRASS FINS	T12	C	6	10	PN PN	9 9	33 3/4 33 3/4	C C	40 40	A A	N	286816
EUCLID																
25 1/4	35 7/16	4 1/2	EUCLID	R-22 DUMP TRUCK 4018449, 4039339 HVY BTM HDR	T	C	6	7	BL BH	7 1/4 7 1/4	39 1/2 39 1/2	C C	36 36	A A	C	223591
25 1/4	35 5/8	4 7/16	EUCLID	R-22 HVY BTM HDR BRASS FINS	Z	B	6	11	BL BH	7 1/4 7 1/4	39 1/2 39 1/2	C C	36 36	A A	C	289132
25 3/8	35 7/16	3 3/4	EUCLID	FD-28	T	C	5	7	BL BL	6 1/4 6 1/4	39 1/2 39 1/2	C C	34 34	H H	C	223620
25 3/8	35 5/8	3 11/16	EUCLID	FD-5	Z	C	5	8	BL BL	6 1/4 6 1/4	39 1/2 39 1/2	1 1/4 1 1/4	34 34	H H	C	287564
25 3/8	35 5/8	3 3/4	EUCLID	FD-5	X	C	5	8	BL BL	6 1/4 6 1/4	39 1/2 39 1/2	C C	34 34	H H	C	266060
28	28 11/16	3 3/4	EUCLID	TC-12 9023576 HVY BTM HDR	T	C	5	7	BL BH	7 1/2 7 1/2	32 32	1 1/2 1 1/2	42 42	A A	C	223289
28	28 11/16	4 1/2	EUCLID	TS-12 HVY BTM HDR	T	C	6	7	BL BH	7 1/2 7 1/2	32 32	C C	42 42	A A	C	275008
28	28 3/4	4 7/16	EUCLID	TC-12 HVY BTM HDR BRASS FINS	Z	B	6	7	BL BH	7 1/2 7 1/2	32 32	C C	42 42	A A	C	287963
28	47 1/2	3 11/16	EUCLID	TEREX 30B HVY T/BTM HDRS	Z	C	5	9	BH BH	8 1/2 8 1/2	51 7/8 51 7/8	C C	50 50	A A	C	282723
29	32 1/16	4 1/2	EUCLID	HVY BTM HDR	T	C	6	7	BL BH	8 3/8 8 3/8	35 5/8 35 5/8	C C	46 46	B B	C	275314
34	40	6	EUCLID	TEREX HVY T/BTM HDRS	B	C	8	8	BH BH	10 1/2 10 1/2	43 3/4 43 3/4	C C	52 52	A A	C	229573
36	53 7/16	3 3/4	EUCLID	EUCLID HVY T/BTM HDRS	T	C	5	7	BH BH	9 1/2 9 1/2	59 59	C C	62 62	A A	CC	272629
36	58 1/8	4 7/16	EUCLID	4083777 HVY T/BTM HDRS	S	C	8	9	BH BH	9 1/2 9 1/2	64 64	C C	66 66	A A	CC	229045
38 1/8	39 15/16	4 1/2	EUCLID	TS-18 SCRAPER HVY T/BTM HDRS	T	C	6	7	BH BH	8 1/2 8 1/2	45 45	C C	54 54	A A	C	223593
40	47 1/4	4 1/2	EUCLID	HVY T/BTM HDRS 1 1/8" BTWN HOLES 4 & 5	T	C	6	8	BH BH	8 1/2 8 1/2	51 7/8 51 7/8	C C	50 50	H H	CC	272858

Vista-Pro Automotive - Core Catalog

(Cores Sorted by Application)

Height	Width	Depth	Application	Description	Fin Type	Fin Matl	Rows	FPI	BH/TH Type	BH/TH Width	BH/TH Length	BH/TH OHF	BH/TH Bolts	BH/TH Shape	Hdr Support	Part #
EUCLID (Cont)																
40	47 1/4	4 1/2	EUCLID	HVY T/BTM HDRS 1 3/4" BTWN HOLES 4 & 5	T	C	6	8	BH BH	8 1/2 8 1/2	51 7/8 51 7/8	C C	50 50	H H	CC	273419
40	47 1/4	5 1/4	EUCLID	TS-24 HVY T/BTM HDRS	T	C	7	7	BH BH	8 1/2 8 1/2	51 7/8 51 7/8	C C	50 50	H H	CC	279068
40	47 1/2	4 7/16	EUCLID	TS-24 4018328, 9028437 HVY T/BTM HDRS BRASS FINS 1 1/8" BTWN HOLES 5 & 6	Z	B	6	9	BH BH	8 1/2 8 1/2	51 7/8 51 7/8	1 5/8 1 5/8	50 50	H H	CC	225639
40	47 1/2	4 7/16	EUCLID	TS-24 HVY BTM HDR BRASS FINS 1 1/8" BTWN HOLES 4 & 5	Z	B	6	7	BL BH	8 1/2 8 1/2	51 7/8 51 7/8	1 5/8 1 5/8	50 50	H H	CC	288440
40	47 1/2	4 5/8	EUCLID	TS-24 HVY T/BTM HDRS	X	C	6	9	BH BH	8 1/2 8 1/2	51 7/8 51 7/8	C C	50 50	H H	CC	266082
44	47 1/2	4 7/16	EUCLID	4018329 HVY T/BTM HDRS BRASS FINS	Z	B	6	9	BH BH	8 1/2 8 1/2	51 7/8 51 7/8	1 5/8 1 5/8	50 50	H H	CC	288927
44	53 7/16	3 3/4	EUCLID	50 TON HVY T/BTM HDRS	T	C	5	8	BH BH	9 1/2 9 1/2	59 59	C C	62 62	A A	CC	272635
44	53 7/16	4 1/2	EUCLID	50 TON 4019474 HVY T/BTM HDRS	T	C	6	7	BH BH	9 1/2 9 1/2	59 59	C C	62 62	A A	CC	279070
44	53 3/4	4 7/16	EUCLID	50 TON 4019474, 4071254 HVY T/BTM HDRS BRASS FINS	Z	B	6	7	BH BH	9 1/2 9 1/2	59 59	C C	62 62	A A	CC	289869
46	66 3/8	4 1/2	EUCLID	R-85 HAUL TRUCK 4094492 HVY T/BTM HDRS	T	C	6	8	BH BH	8 1/2 8 1/2	70 1/4 70 1/4	C C	68 68	A A	CC	223595
F.W.D.																
24 3/4	31 7/8	3 7/16	F.W.D.		R	C	6	11	BL BL	6 5/8 6 5/8	34 34	C C	42 42	A A	C	226448
31 1/8	37 1/2	4 7/16	F.W.D.	HVY BTM HDR BRASS FINS	Z	B	6	11	BL BH	9 1/4 9 1/4	39 5/8 39 5/8	1 1/2 1 1/2	52 52	A A	C	289125
FAIRBANKS MORSE																
15 3/4	16 7/8	1 7/8	FAIRBANKS-MORSE	ZC-346 HVY BTM HDR W/TANK & SIDES	X	C	2	7	SQ BH	2 3 5/8	16 13/16 20 1/2	C C	11 11	A A	C	221328
20 1/4	18 9/16	3	FAIRBANKS-MORSE	CONTINENTAL ENGINE	T	C	4	8	GR GR	4 1/8 4 1/8	20 20	1/4 1/4		A A	N	223083
FERMONT																
60 5/8	58 3/4	3 7/16	FERMONT	FERMONT GENSET X-3159 HVY BTM HDR	R	C	6	11	BL BH	9 9	62 7/8 62 7/8	C C	72 72	A A	CC	226235
FERRARI																
12 1/4	25 7/8	2 5/8	FERRARI		VT	C	4	12		2 5/8 2 5/8	26 26	C C		0 0	N	128512
15 1/4	27 9/16	2 1/4	FERRARI		T	C	3	11	GR GR	5 1/8 2 3/8	27 7/8 27 7/8	3/8 3/8		A A	N	265051
FIAT																
11 1/2	18 11/16	1 1/4	FIAT		VT	C	2	12	GR GR	2 2	19 19	C C		A A	N	124799
13	11 9/16	2	FIAT		VT	C	3	16		3 2 5/8	12 12	C C		0 0	N	128414
13 7/8	18 11/16	1 1/4	FIAT		VT	C	2	16	GR GR	1 7/8 1 7/8	18 15/16 18 15/16	C C		A A	N	128203
13 7/8	20 1/4	1 9/16	FIAT		VE	C	3	16	GR GR	1 15/16 1 15/16	20 9/16 20 9/16	C C		A A	N	124968
14	18 11/16	2	FIAT		VT	C	3	12		2 2	19 19	C C		0 0	N	122312
25 3/4	9 7/8	1 1/4	FIAT		VT	C	2	12		1 3/4 1 3/4	10 1/4 10 1/4	C C		0 0	N	124751

Vista-Pro Automotive - Core Catalog

(Cores Sorted by Application)

Height	Width	Depth	Application	Description	Fin Type	Fin Matl	Rows	FPI	BH/TH Type	BH/TH Width	BH/TH Length	BH/TH OHF	BH/TH Bolts	BH/TH Shape	Hdr Support	Part #
FIAT ALLIS																
13 1/4	15 3/16	2 1/4	FIAT ALLIS		T	C	3	7	GR	3 1/8	15 1/2	1/4		A	N	260118
									GR	2 1/2	15 1/2	1/4		A	N	
14	14 5/8	2 1/4	FIAT ALLIS	D-12	T	C	3	8	GR	4 3/8	15	1/4		A	N	223597
									GR	2 1/2	15	C		A	N	
14 1/2	14 3/8	2 3/16	FIAT ALLIS		Z	C	3	9	GR	4 3/8	15	3/16		A	N	281708
									GR	2 1/2	15	3/16		A	N	
14 1/2	14 5/8	2 1/4	FIAT ALLIS		T	C	3	7	GR	4 3/8	15	1/4		A	N	223120
									GR	2 1/2	15	1/4		A	N	
14 1/2	15	2 1/4	FIAT ALLIS		X	C	3	7	GR	4 3/8	15	1/8		A	N	221806
									GR	2 1/2	15	1/8		A	N	
15	20 5/8	2 1/4	FIAT ALLIS	170	X	C	3	9	GR	3 1/2	21 1/2	3/16		A	N	221860
									GR	3 1/2	21 1/2	3/16		A	N	
15 1/4	15 5/8	2 1/4	FIAT ALLIS	D-14	X	C	3	8	GR	3 3/8	15 7/8	3/16		A	N	289507
									GR	3 3/8	15 7/8	3/16		A	N	
15 1/4	15 3/4	2 1/4	FIAT ALLIS		T	C	3	7	GR	3 3/8	15 7/8	1/8		A	N	278590
									GR	3 3/8	15 7/8	1/8		A	N	
16 1/4	16 7/8	2 7/8	FIAT ALLIS	LIFT TRUCK 4882935	S	C	5	7	GR	3 3/8	18	C		A	N	229181
									GR	3 3/8	18	C		A	N	
16 1/4	17 7/16	2 1/4	FIAT ALLIS		T	C	3	8	GR	3 3/8	18	1/8		A	N	223626
									GR	3 3/8	18	1/8		A	N	
16 1/4	18	3	FIAT ALLIS	H3 HD3	T	C	4	8	GR	5 3/8	18 1/4	3/8		A	N	277717
									GR	4 1/4	18 1/4	3/8		A	N	
16 1/4	18 1/8	2 1/4	FIAT ALLIS		X	C	3	8	GR	5 3/8	18 1/4	3/8		A	N	260340
									GR	2 7/8	18 1/4	3/8		A	N	
16 1/2	18	2 1/4	FIAT ALLIS	D-15	T	C	3	8	GR	5 1/2	18 1/4	1/4		A	N	223598
									GR	3	18 1/4	1/4		A	N	
16 7/8	17 1/2	3	FIAT ALLIS		X	C	4	7	GR	3 7/8	17 7/8	1/8		A	N	266233
									GR	3 7/8	17 7/8	1/8		A	N	
17	19 1/8	2 1/4	FIAT ALLIS	FR-70	T	C	3	8	GR	4	19 7/8	1/8		A	N	223134
									GR	4	19 7/8	1/8		A	N	
17 3/4	18 3/4	2 15/16	FIAT ALLIS	LIFT TRUCK	Z	C	4	7	GR	6	19 3/4	3/16		A	N	287640
									GR	3 7/16	19 3/4	3/16		A	N	
18 1/8	18 1/8	2 3/8	FIAT ALLIS	TRACTOR	S	C	4	8	GR	5 3/8	18 1/8	1/8		A	N	266097
									GR	2 3/4	18 1/8	1/8		A	N	
18 1/8	19 1/8	2 1/4	FIAT ALLIS		T	C	3	7	GR	5 7/8	19 3/4	1/4		A	N	261636
									GR	3 3/8	19 3/4	1/4		A	N	
18 1/4	18	2 1/4	FIAT ALLIS	WC-D	T	C	3	7	GR	5 3/8	18 1/4	1/8		A	N	223122
									GR	2 7/8	18 1/4	1/8		A	N	
18 1/4	18	3	FIAT ALLIS	WD-45	T	C	4	6	GR	5 3/8	18 1/4	3/16		A	N	262813
									GR	3	18 1/4	C		A	N	
18 1/4	18 1/8	2 3/16	FIAT ALLIS	WD-45	Z	C	3	7	GR	5 3/8	18 1/4	3/16		A	N	225426
									GR	2 7/8	18 1/4	3/16		A	N	
18 1/4	18 1/8	2 1/4	FIAT ALLIS	TL-10	X	C	3	6	GR	5 3/8	18 1/4	1/4		A	N	265919
									GR	2 7/8	18 1/4	1/4		A	N	
18 1/4	23 1/16	3 3/4	FIAT ALLIS	190 XT TRACTOR	T	C	5	10	FR	3 7/8	23 3/4	C		0	N	223123
									FR	3 7/8	23 3/4	C		0	N	
18 1/4	23 1/8	3	FIAT ALLIS	190 XT	X	C	4	9	GR	3 7/8	23 3/4	1/4		A	N	289424
									GR	3 7/8	23 3/4	1/4		A	N	
18 3/8	18	2 1/4	FIAT ALLIS	WD-45	T	C	3	6	CR	5 3/4	18 1/4	3/16		A	N	223148
									CR	3 1/4	18 1/4	3/16		A	N	
18 3/8	18 1/8	1 7/8	FIAT ALLIS	WD-45	X	C	2	8	CR	5 3/4	18 1/4	3/8		A	N	287811
									CR	3 1/4	18 1/4	1/4		A	N	
18 3/8	19 3/8	2 1/4	FIAT ALLIS		X	C	3	9	GR	6	19 5/8	5/8		A	N	260358
									GR	3 1/2	19 5/8	5/8		A	N	

Vista-Pro Automotive - Core Catalog

(Cores Sorted by Application)

Height	Width	Depth	Application	Description	Fin Type	Fin Matl	Rows	FPI	BH/TH Type	BH/TH Width	BH/TH Length	BH/TH OHF	BH/TH Bolts	BH/TH Shape	Hdr Support	Part #
FIAT ALLIS (Cont)																
18 1/2	23 1/8	2 3/8	FIAT ALLIS		S	C	4	8	GR	3 7/8	23 3/4	1/4		A	N	266157
									GR	3 7/8	23 3/4	1/4		A	N	
19 3/8	17 1/2	2 1/4	FIAT ALLIS	HD-17	X	C	3	6	GR	5 3/8	18	3/16		A	N	221807
									GR	2 5/8	18	3/16		A	N	
19 3/8	17 1/2	3	FIAT ALLIS	HD-17	X	C	4	9	GR	5 3/8	18	3/16		A	N	289459
									GR	4	18	3/16		A	N	
19 3/8	18	2 1/4	FIAT ALLIS	HD-17	T	C	3	8	GR	5 3/8	18	1/4		A	N	223127
									GR	2 5/8	18	1/4		A	N	
19 3/8	18 1/8	2 1/4	FIAT ALLIS		X	C	3	8	GR	5 3/8	18	3/16		A	N	266129
									GR	2 5/8	18	C		A	N	
19 3/8	18 1/8	3 3/4	FIAT ALLIS	HD-17	X	C	5	8	GR	5 3/8	18	FF		A	N	260362
									GR	3 7/8	18	C		A	N	
19 3/8	18 9/16	2 1/4	FIAT ALLIS	G-226	T	C	3	7	GR	6	19 3/4	3/8		A	N	274984
									GR	3 7/16	19 3/4	3/8		A	N	
19 3/8	18 3/4	2 1/4	FIAT ALLIS		X	C	3	8	GR	6	19 3/4	5/8		A	N	260363
									GR	3 1/2	19 3/4	5/8		A	N	
19 3/8	18 3/4	2 3/8	FIAT ALLIS	540 LOADER 1011218-03	S	C	4	6	GR	3 3/8	19 3/4	C		A	N	229183
									GR	3 3/8	19 3/4	C		A	N	
19 3/8	18 3/4	2 15/16	FIAT ALLIS		Z	C	4	6	GR	3 3/8	19 3/4	C		A	N	281699
									GR	3 3/8	19 3/4	C		A	N	
19 1/2	29 1/4	3 3/4	FIAT ALLIS	TL-545 LOADER	T	C	5	7	GR	5	29 3/4	1/8		A	N	223158
									GR	5	29 3/4	1/8		A	N	
20	23	3 3/4	FIAT ALLIS	COTTON PICKER BRASS FINS	B	B	5	6	GR	4	23 3/4	C		A	N	278614
									GR	4	23 3/4	C		A	N	
20	23 1/8	3 11/16	FIAT ALLIS	COTTON PICKER	Z	C	5	9	GR	4 3/8	23 3/4	C		A	N	286662
									GR	4 3/8	23 3/4	C		A	N	
20	23 1/8	3 11/16	FIAT ALLIS	BALDWIN GLEANER	Z	C	5	7	GR	4	23 3/4	C		A	N	289865
									GR	4	23 3/4	C		A	N	
20 1/2	25	2 7/8	FIAT ALLIS	840 LOADER 71007924	S	C	5	7	GR	4 1/8	25 3/4	C		A	N	229188
									GR	4 1/8	25 3/4	C		A	N	
20 1/2	25	3 7/16	FIAT ALLIS	840 LOADER 73141093	S	C	6	7	GR	4 1/8	25 3/4	C		A	N	229189
									GR	4 1/8	25 3/4	C		A	N	
21	21 7/8	2 3/16	FIAT ALLIS	HD-5 BRASS FINS	Z	B	3	9	GR	4	22 3/4	3/16		A	N	285000
									GR	2 1/2	22 3/4	3/16		A	N	
21	21 15/16	2 1/4	FIAT ALLIS	HD-5 BRASS FINS	T	B	3	7	GR	4	22 3/4	1/4		A	N	260117
									GR	2 1/2	22 3/4	1/4		A	N	
21	22	2 1/4	FIAT ALLIS	HD-5 BRASS FINS FACE DIPPED	B	B	3	6	GR	4	22 3/4	1/8		A	N	274510
									GR	2 1/2	22 3/4	1/8		A	N	
21 3/4	18	2 1/4	FIAT ALLIS	D-19	T	C	3	8	GR	5 3/8	18	1/4		A	N	223619
									GR	2 1/2	18	1/4		A	N	
21 3/4	18	3	FIAT ALLIS	D-19	T	C	4	8	GR	5 3/8	18	3/16		A	N	278620
									GR	4	18	3/16		A	N	
21 3/4	18 1/8	2 15/16	FIAT ALLIS	D-19	Z	C	4	9	GR	5 3/8	18	3/16		A	N	289268
									GR	4	18	3/16		A	N	
22 1/4	26 7/8	2 7/8	FIAT ALLIS	940 LOADER 1005966-05	S	C	5	6	GR	4 1/8	27 1/4	C		A	N	229190
									GR	4 1/8	27 1/4	C		A	N	
23	20 1/4	2 1/4	FIAT ALLIS	CRAWLER 1" X 2 1/2" ELONGATED HOLE CTRD ON BTM HDR	T	C	3	6	BL	7 1/4	23	1 5/16	24	H	C	261467
									BL	5 3/4	23	1 5/16	22	F	C	
23	20 5/8	2 3/16	FIAT ALLIS	U-40 1" X 2 1/2" ELONGATED HOLE CTRD ON BTM HDR	Z	C	3	8	BL	7 1/4	23	1 1/4	24	J	C	281467
									BL	5 3/4	23	1 1/8	24	F	C	
23	23 1/2	3 3/4	FIAT ALLIS	880 COTTON STRIPPER	B	C	5	7	GR	4	24	C		A	N	229513
									GR	4	24	C		A	N	
23	24 3/8	3	FIAT ALLIS	HD-6	X	C	4	9	GR	4 3/4	25 3/4	3/16		A	N	287094
									GR	4 3/4	25 3/4	3/16		A	N	

Vista-Pro Automotive - Core Catalog

(Cores Sorted by Application)

Height	Width	Depth	Application	Description	Fin Type	Fin Matl	Rows	FPI	BH/TH Type	BH/TH Width	BH/TH Length	BH/TH OHF	BH/TH Bolts	BH/TH Shape	Hdr Support	Part #
FIAT ALLIS (Cont)																
23	25	3 11/16	FIAT ALLIS	HD-6 BRASS FINS	Z	B	5	10	GR GR	4 3/4 4 3/4	25 3/4 25 3/4	3/16 3/16		A A	N	285001
23	25	3 3/4	FIAT ALLIS	HD-6 BRASS FINS FACE DIPPED	B	B	5	6	GR GR	4 3/4 4 3/4	25 3/4 25 3/4	1/4 1/4		A A	N	229551
23	28 3/4	3 11/16	FIAT ALLIS	605	Z	C	5	7	BL BL	7 3/8 7 3/8	31 1/8 31 1/8	1 3/8 1 3/8	40 40	A A	C	289322
23	29	3 3/4	FIAT ALLIS	645 LOADER	B	C	5	7	GR GR	4 4	29 5/8 29 5/8	C C		A A	N	278621
23	29 1/4	3 3/4	FIAT ALLIS	645 FRONT END LOADER	T	C	5	7	BL BL	7 3/8 7 3/8	31 1/4 31 1/4	1 1/2 1 1/2	40 40	A A	C	265862
23	29 3/8	3 11/16	FIAT ALLIS	645 LOADER	Z	C	5	8	GR GR	4 4	29 5/8 29 5/8	C C		A A	N	289435
23 1/4	21 1/4	1 3/4	FIAT ALLIS	320 BACKHOE 76022357	S	C	3	8	GR GR	3 7/16 3 7/16	21 7/8 21 7/8	1/8 1/8		A A	N	229191
23 3/4	23 1/16	3	FIAT ALLIS	220	T	C	4	8	GR GR	4 4	23 5/8 23 5/8	C C		A A	N	278625
24	29 1/4	4 1/2	FIAT ALLIS	COMBINE	T	C	6	6	GR GR	4 3/4 4 3/4	29 3/4 29 3/4	C C		A A	C	278626
24	29 3/8	3 11/16	FIAT ALLIS	COMBINE	Z	C	5	7	GR GR	4 3/4 4 3/4	29 3/4 29 3/4	C C		A A	C	286400
24	29 3/8	4 5/8	FIAT ALLIS	COMBINE	X	C	6	6	GR GR	4 3/4 4 3/4	29 3/4 29 3/4	C C		A A	C	266258
24 1/2	26 1/4	3 11/16	FIAT ALLIS	7050	Z	C	5	9	GR GR	4 4	26 1/2 26 1/2	C C		A A	C	286716
24 5/8	26 1/4	2 3/8	FIAT ALLIS	8010 TRACTOR 264168	S	C	4	11	GR GR	4 1/4 4 1/4	26 5/8 26 5/8	1/8 1/8		A A	C	229180
24 5/8	26 1/4	2 7/8	FIAT ALLIS	8030 TRACTOR 275254	S	C	5	11	GR GR	4 1/4 4 1/4	26 5/8 26 5/8	1/4 1/4		A A	C	229178
24 5/8	26 1/4	3	FIAT ALLIS	7030	X	C	4	10	GR GR	4 4	26 1/2 26 1/2	C C		A A	C	286715
24 5/8	26 1/4	3 7/16	FIAT ALLIS	8030, 8050 264227	S	C	6	11	GR GR	4 1/4 4 1/4	26 5/8 26 5/8	1/8 1/8		A A	C	229179
24 7/8	26 1/4	3	FIAT ALLIS	TL-20	X	C	4	8	GR GR	4 4	26 3/4 26 3/4	1/4 1/4		A A	C	266163
24 7/8	26 1/4	3 11/16	FIAT ALLIS	TL-30	Z	C	5	8	GR GR	4 4	26 3/4 26 3/4	3/8 3/8		A A	C	289083
25	23 1/8	3 3/4	FIAT ALLIS	D-21	X	C	5	8	GR GR	4 4	23 3/4 23 3/4	C C		A A	C	289522
25 1/2	25	3 11/16	FIAT ALLIS	HD-7G BRASS FINS	Z	B	5	8	GR GR	4 3/4 4 3/4	25 3/4 25 3/4	3/16 3/16		A A	C	285027
25 7/8	26 1/4	3 7/16	FIAT ALLIS	8070 TRACTOR 264229	S	C	6	10	GR GR	4 1/4 4 1/4	26 5/8 26 5/8	1/8 1/8		A A	C	229192
25 7/8	26 1/2	3 3/4	FIAT ALLIS	7080	B	C	5	7	GR GR	3 7/8 3 7/8	26 5/8 26 5/8	C C		A A	C	272779
26 1/2	25	3	FIAT ALLIS	HD-9	X	C	4	6	GR GR	4 5/8 3 1/8	25 3/4 25 3/4	3/16 3/16		A A	C	265948
27 3/8	24 3/8	5 1/4	FIAT ALLIS	GLENER COMBINE	X	C	7	8	GR GR	6 1/4 6 1/4	24 3/4 24 3/4	C C		A A	C	260397
27 1/2	24	5 1/4	FIAT ALLIS	BALDWIN GLENER	B	C	7	6	GR GR	6 1/4 6 1/4	24 3/4 24 3/4	5/8 5/8		A A	C	272780
27 1/2	24 3/8	5 3/16	FIAT ALLIS	BALDWIN GLENER BRASS FINS	Z	B	7	6	GR GR	5 7/8 5 7/8	24 7/8 24 7/8	C C		A A	C	289866
28 7/8	26 1/4	3 15/16	FIAT ALLIS	273317	S	C	7	10	GR GR	4 1/4 4 1/4	26 5/8 26 5/8	C C		A A	C	229182

Vista-Pro Automotive - Core Catalog

(Cores Sorted by Application)

Height	Width	Depth	Application	Description	Fin Type	Fin Matl	Rows	FPI	BH/TH Type	BH/TH Width	BH/TH Length	BH/TH OHF	BH/TH Bolts	BH/TH Shape	Hdr Support	Part #
FIAT ALLIS (Cont)																
29 1/2	24 3/16	3 3/4	FIAT ALLIS	HD-7G HVY BTM HDR	T	C	5	8	BL BH	6 7/8 6 7/8	26 26	1 3/8 1 3/8	42 42	A A	C	265431
30	28 1/8	4 1/2	FIAT ALLIS	750 LOADER	T	C	6	8	GR GR	4 7/8 4 7/8	29 3/4 29 3/4	1/8 1/8		A A	C	278640
30	28 3/4	4 7/16	FIAT ALLIS	645 LOADER BRASS FINS	Z	B	6	8	BL BL	7 1/4 7 1/4	31 1/4 31 1/4	C C	40 40	A A	C	286518
30	29	3 3/4	FIAT ALLIS	HD-11 HVY BTM HDR BRASS FINS FACE DIPPED	B	B	5	6	BL BH	6 5/8 6 5/8	32 1/4 32 1/4	C C	44 44	A A	C	274513
30	29	4 1/2	FIAT ALLIS	750 LOADER HVY T/BTM HDRS BRASS FINS FACE DIPPED	B	B	6	6	BH BH	7 1/4 7 1/4	31 1/4 31 1/4	C C	40 40	A A	C	272456
30	29 3/8	3 11/16	FIAT ALLIS	HD-11	Z	C	5	8	BL BL	6 5/8 6 5/8	32 1/4 32 1/4	1 5/8 1 5/8	44 44	A A	C	225499
30	31 1/2	4 1/2	FIAT ALLIS	HD-11 HVY T/BTM HDRS BRASS FINS FACE DIPPED	B	B	6	7	BH BH	7 5/8 7 5/8	34 7/8 34 7/8	C C	44 44	A A	C	278639
30	31 1/2	5 1/4	FIAT ALLIS	HD-11 HVY T/BTM HDRS BRASS FINS	T	B	7	7	BH BH	7 5/8 7 5/8	34 7/8 34 7/8	C C	44 44	A A	C	264117
32	31 1/4	4 7/16	FIAT ALLIS	HVY T/BTM HDRS BRASS FINS	Z	B	6	9	BH BH	8 1/4 8 1/4	33 3/4 33 3/4	C C	44 44	A A	C	282741
32 1/2	34 3/8	4 7/16	FIAT ALLIS	HD-11 HVY T/BTM HDRS BRASS FINS	Z	B	6	7	BH BH	7 5/8 7 5/8	37 7/8 37 7/8	1 5/16 1 5/16	48 48	A A	C	289448
32 1/2	34 1/2	4 1/2	FIAT ALLIS	HD-11B HVY T/BTM HDRS BRASS FINS FACE DIPPED	B	B	6	6	BH BH	7 5/8 7 5/8	37 7/8 37 7/8	C C	48 48	A A	C	277122
32 1/2	34 7/8	4 1/2	FIAT ALLIS	HD-11 HVY T/BTM HDRS BRASS FINS	T	B	6	7	BH BH	7 5/8 7 5/8	37 7/8 37 7/8	C C	48 48	A A	C	265351
34 1/4	38 1/4	3 3/4	FIAT ALLIS	261 SCRAPER HVY BTM HDR	T	C	5	9	BL BH	8 1/4 8 1/4	41 1/2 41 1/2	C C	54 54	A A	C	278644
35 3/4	37 1/2	4 7/16	FIAT ALLIS	HD-16 HVY BTM HDR BRASS FINS	Z	B	6	7	BL BH	7 3/8 7 3/8	40 3/8 40 3/8	C C	50 50	A A	C	225495
37 3/4	37 1/2	4 7/16	FIAT ALLIS	HD-16B HVY BTM HDR BRASS FINS	Z	B	6	7	BL BH	7 3/8 7 3/8	40 3/8 40 3/8	C C	50 50	A A	C	289498
37 3/4	37 11/16	4 1/2	FIAT ALLIS	HD-16B HVY BTM HDR BRASS FINS	T	B	6	7	BL BH	7 3/8 7 3/8	40 3/8 40 3/8	C C	50 50	A A	C	265236
38 1/2	41 1/4	4 7/16	FIAT ALLIS	HD-21 HVY T/BTM HDRS BRASS FINS	Z	B	6	11	BH BH	8 8	44 1/2 44 1/2	1 5/8 1 5/8	56 56	A A	CC	225518
38 1/2	41 1/2	4 1/2	FIAT ALLIS	HD-21 HVY T/BTM HDRS BRASS FINS FACE DIPPED	B	B	6	6	BH BH	8 8	44 1/2 44 1/2	C C	56 56	A A	CC	274202
41 1/2	34 7/8	3 3/4	FIAT ALLIS	25,000 HVY BTM HDR SPECIFY BH SPACING	T	C	5	7	BL BH	7 1/4 7 1/4	37 1/2 37 1/2	1 1/2 1 1/2	46 46	B B	C	272450
41 1/2	34 7/8	3 3/4	FIAT ALLIS	25,000 HVY T/BTM HDRS SPECIFY BH SPACING	T	C	5	7	BH BH	7 1/4 7 1/4	37 1/2 37 1/2	1 1/2 1 1/2	48 48	B B	C	275433
44 1/2	42 1/2	4 7/16	FIAT ALLIS	HD-21C 70687292 HVY T/BTM HDRS BRASS FINS	Z	B	6	8	BH BH	8 8	44 1/2 44 1/2	1 1/2 1 1/2	54 54	A A	CC	286519
45 3/8	36 7/8	4 7/16	FIAT ALLIS	HD-20 BRASS FINS	Z	B	6	7	SQ SQ	5 1/4 5 1/4	37 1/4 37 1/4	C C		A A	C	282170
51	52 1/2	4 1/2	FIAT ALLIS	HD-41 HVY T/BTM HDRS 1 7/8" SPACE BTWN CORES	B	C	6	9	BH BH	8 1/4 8 1/4	55 1/2 55 1/2	C C	70 70	A A	CC	229554
FIREBIRD																
23	17 1/16	2	FIREBIRD		VT	C	3	12	GR GR	2 3/4 2 3/4	18 5/8 18 5/8	C C		A A	N	122530
27 1/2	17 1/16	1 1/4	FIREBIRD		VT	C	2	12	GR GR	2 3/4 2 3/4	18 5/8 18 5/8	3/8 3/8		A A	N	124733

Vista-Pro Automotive - Core Catalog

(Cores Sorted by Application)

Height	Width	Depth	Application	Description	Fln Type	Fln Matl	Rows	FPI	BH/TH Type	BH/TH Width	BH/TH Length	BH/TH OHF	BH/TH Bolts	BH/TH Shape	Hdr Support	Part #
FIREBIRD (Cont)																
27 1/2	17 1/16	2	FIREBIRD		VT	C	3	12	GR	2 3/4	18 5/8	C		A	N	124570
									GR	3 1/2	18 5/8	C		A		
27 1/2	17 1/16	2	FIREBIRD		VT	C	3	12	GR	2 3/4	18 5/8	C		A	N	124734
									GR	2 3/4	18 5/8	C		A		
FLXIBLE BUS																
30 1/2	33 1/8	3 3/4	FLXIBLE BUS	6V-92 HVY T/BTM HDRS	X	C	5	10	BH	7	36 5/16	1 3/4	46	A	C	221900
									BH	7	36 5/16	1 3/4	46	A		
30 1/2	36 7/8	3 15/16	FLXIBLE BUS	DETROIT DIESEL 97-8550-00151	S	C	7	11	BL	7	38 7/8	C	48	A	C	229206
									BL	7	38 7/8	C	48	A		
38 7/8	14 3/8	3 15/16	FLXIBLE BUS		R	C	7	10	BL	6 1/4	15 7/8	C	22	0	C	221276
									BL	6 1/4	15 7/8	FF	22	A		
38 7/8	15 5/8	3 15/16	FLXIBLE BUS		R	C	7	10	BL	7	17 5/8	C	26	A	C	221277
									BL	7	17 5/8	FF	26	A		
39	15 5/8	4 7/16	FLXIBLE BUS		R	C	8	11	BL	7	17 5/8	C	26	A	C	226866
									BL	7	17 5/8	C	26	A		
FORD																
14	17 5/8	2	FORD		VT	C	3	12	GR	4	17 3/4	1 7/8		A	N	128440
									GR	2 1/16	17 3/4	C		A		
14 5/8	24 3/16	1 1/4	FORD		VT	C	2	12	GR	2 13/16	24 5/8	5/8		A	N	124551
									GR	1 3/4	24	C		A		
15 3/16	17 1/16	1 1/4	FORD		VT	C	2	12	BU	3 1/8	17 3/8	C		A	N	122281
									GR	1 5/8	16 3/4	C		A		
15 1/4	17 1/16	1 1/4	FORD		VT	C	2	12	BU	3 1/8	17 3/8	C		A	N	124720
									GR	1 5/8	16 3/4	C		A		
15 1/4	17 1/16	1 1/4	FORD		VT	C	2	14	BU	3 1/8	17 3/8	C		A	N	128606
									GR	1 5/8	16 3/4	C		A		
15 1/4	17 1/16	2	FORD		VT	C	3	12	BU	3 1/8	17 3/8	C		A	N	128334
									FR	2 3/16	16 3/4	C		A		
15 1/4	17 1/16	2	FORD		VT	C	3	12	BU	3 1/8	17 3/8	C		A	N	128335
									GR	2 3/16	16 3/4	C		A		
15 1/4	17 5/8	1 1/4	FORD		VT	C	2	12	GR	1 7/8	17 3/4	C		A	N	124586
									GR	1 7/8	17 3/4	C		A		
15 1/2	19 13/16	2	FORD		VT	C	3	12	GR	2 5/16	19 7/8	C		A	N	124746
									GR	2 5/16	19 7/8	C		A		
15 1/2	20 3/8	2	FORD		VT	C	3	13	GR	2 5/16	19 7/8	C		A	N	124540
									GR	2 5/16	19 7/8	C		A		
15 1/2	20 3/8	2 5/8	FORD		VT	C	4	12	GR	2 3/4	19 7/8	C		A	N	128676
									GR	2 3/4	19 7/8	C		A		
15 1/2	37 15/16	2 5/8	FORD		VT	C	4	16	GR	3 5/8	37 5/8	C		A	N	128565
									GR	3 5/8	37 5/8	C		A		
15 7/8	23 1/8	1 1/4	FORD		VT	C	2	12	GR	2 1/2	22 7/8	C		A	N	124533
									GR	1 5/8	22 3/4	C		A		
15 7/8	23 1/8	2	FORD		VT	C	3	12	GR	2 1/2	22 7/8	C		A	N	122535
									GR	2 1/2	22 7/8	C		A		
16	23 1/8	2 5/8	FORD		VT	C	4	12	GR	2 3/4	23	C		A	N	128675
									GR	2 3/4	23	C		A		
16	24 3/16	2 5/8	FORD		VT	C	4	12	GR	2 3/4	23 7/8	C		A	N	128674
									GR	2 3/4	23 7/8	C		A		
16 1/8	17 5/8	2	FORD		VT	C	3	12	GR	2 5/8	17 1/2	C		A	N	122502
									GR	2 5/8	17 1/2	C		A		
16 3/8	17 1/16	1 1/4	FORD	FALCON	VT	C	2	12	BU	3 1/8	17 3/8	C		A	N	122422
									GR	1 5/8	16 3/4	C		A		
16 3/8	17 1/16	1 1/4	FORD		VT	C	2	12	BU	3 1/8	17 3/8	C		A	N	122501
									GR	1 5/8	16 3/4	C		A		

Vista-Pro Automotive - Core Catalog

(Cores Sorted by Application)

Height	Width	Depth	Application	Description	Fin Type	Fin Matl	Rows	FPI	BH/TH Type	BH/TH Width	BH/TH Length	BH/TH OHF	BH/TH Bolts	BH/TH Shape	Hdr Support	Part #
FORD (Cont)																
16 3/8	17 1/16	1 1/4	FORD		VT	C	2	12	BU GR	3 3/16 1 5/8	17 3/8 16 3/4	C C		A A	N	124743
16 3/8	17 1/16	1 1/4	FORD		VT	C	2	12	BU GR	3 1/8 1 5/8	17 3/8 16 3/4	C C		A A	N	128616
16 3/8	17 1/16	1 1/4	FORD		VT	C	2	12	BU GR	3 1/8 1 5/8	17 3/8 16 3/4	C C		A A	N	128617
16 3/8	17 1/16	2	FORD	FALCON	VT	C	3	12	BU GR	3 1/8 2 1/4	17 3/8 16 7/8	C C		A A	N	122468
16 3/8	17 1/16	2	FORD		VT	C	3	12	BU GR	3 1/8 2 1/4	17 3/8 16 7/8	C C		A A	N	122534
16 3/8	17 1/16	2	FORD		VT	C	3	12	BU GR	3 1/8 2 1/4	17 3/8 16 7/8	C C		A A	N	124804
16 3/8	17 1/16	2	FORD		VT	C	3	12	BU FR	3 1/8 2 1/8	17 3/8 16 3/4	C C		A A	N	128618
16 3/8	20 1/4	1 9/16	FORD		VE	C	3	14	BU GR	3 3/16 1 3/4	20 7/16 19 13/16	C C		A A	N	128380
16 3/8	20 3/8	1 1/4	FORD		VT	C	2	12	BU GR	3 3/16 1 5/8	20 7/16 19 13/16	C C		A A	N	124514
16 3/8	20 3/8	1 1/4	FORD		VT	C	2	12	BU GR	3 3/16 1 5/8	20 7/16 19 13/16	C C		A A	N	128624
16 3/8	20 3/8	2	FORD		VT	C	3	12	BU FR	3 3/16 2	20 7/16 19 7/8	C C		A A	N	122268
16 3/8	20 3/8	2	FORD		VT	C	3	12	BU GR	3 3/16 2 5/16	20 7/16 19 7/8	C C		A A	N	124689
16 3/8	20 3/8	2	FORD		VT	C	3	12	BU GR	3 3/16 2	20 7/16 19 13/16	C C		A A	N	122608
16 3/8	20 3/8	2	FORD		VT	C	3	12	BU GR	3 3/16 2 5/16	20 7/16 19 7/8	C C		A A	N	124690
16 3/8	20 3/8	2	FORD		VT	C	3	12	BU GR	3 3/16 2 5/16	20 7/16 19 7/8	C C		A A	N	124695
16 3/8	23 1/8	1 1/4	FORD		VT	C	2	12	BU GR	4 1/4 2 1/4	25 3/4 23 3/4	C C		A A	N	122233
16 3/8	23 5/8	2	FORD		VT	C	3	12	GR GR	2 3/4 2 3/4	23 7/8 23 7/8	C C		A A	N	124515
17	19 3/8	1 7/8	FORD		X	C	2	6	SQ SQ	6 5/8 2 5/8	19 19	FF C		A A	N	265939
17 1/4	22	2	FORD		VT	C	3	12	BU GR	4 1/8 2 9/16	23 22	C C		A A	N	122226
17 3/8	17 1/16	1 1/4	FORD		VT	C	2	12	BU GR	3 1/8 1 5/8	17 3/8 16 3/4	C C		A A	N	122351
17 3/8	17 1/16	1 1/4	FORD		VT	C	2	12	BU GR	3 1/8 1 5/8	17 3/8 16 3/4	C C		A A	N	122374
17 3/8	17 1/16	1 1/4	FORD		VT	C	2	12	BU GR	3 1/8 1 5/8	17 3/8 16 7/8	C C		A A	N	122392
17 3/8	17 1/16	2	FORD		VT	C	3	12	BU GR	3 1/8 2 1/4	17 3/8 16 7/8	C C		A A	N	122321
17 3/8	17 5/8	2	FORD		VT	C	3	12	GR GR	2 5/8 2 5/8	17 1/2 17 1/2	C C		A A	N	124644
17 3/8	20 3/8	1 1/4	FORD		VT	C	2	12	BU GR	3 3/16 1 5/8	20 7/16 19 13/16	C C		A A	N	122429
17 3/8	20 3/8	1 1/4	FORD		VT	C	2	12	BU GR	3 3/16 1 5/8	20 7/16 19 13/16	C C		A A	N	122475
17 3/8	20 3/8	1 1/4	FORD		VT	C	2	12	BU GR	3 3/16 1 5/8	20 7/16 19 13/16	C C		A A	N	122590

Vista-Pro Automotive - Core Catalog

(Cores Sorted by Application)

Height	Width	Depth	Application	Description	Fin Type	Fin Matl	Rows	FPI	BH/TH Type	BH/TH Width	BH/TH Length	BH/TH OHF	BH/TH Bolts	BH/TH Shape	Hdr Support	Part #
FORD (Cont)																
17 3/8	20 3/8	1 1/4	FORD		VT	C	2	12	BU GR	3 3/16 1 5/8	20 7/16 19 13/16	C C		A A	N	122442
17 3/8	20 3/8	1 1/4	FORD		VT	C	2	12	BU GR	3 3/16 1 5/8	20 7/16 19 13/16	C C		A A	N	122477
17 3/8	20 3/8	1 1/4	FORD		VT	C	2	12	BU GR	3 3/16 1 5/8	20 7/16 19 13/16	C C		A A	N	124763
17 3/8	20 3/8	1 1/4	FORD		VT	C	2	12	BU GR	3 3/16 1 5/8	20 7/16 19 13/16	C C		A A	N	128610
17 3/8	20 3/8	2	FORD		VT	C	3	12	BU GR	3 3/16 2 5/16	20 7/16 19 7/8	C C		A A	N	122597
17 3/8	20 3/8	2	FORD		VT	C	3	16	BU FR	3 3/16 2	20 7/16 19 13/16	C C		A A	N	122605
17 3/8	20 3/8	2	FORD		VT	C	3	12	BU FR	3 3/16 2 1/8	20 7/16 19 13/16	C C		A A	N	128614
17 3/8	20 3/8	2 5/8	FORD		VT	C	4	12	GR GR	3 1/8 3 1/8	20 1/2 20 1/2	C C		A A	N	128506
17 3/8	23 1/8	1 1/4	FORD		VT	C	2	12	BU GR	3 3/16 1 5/8	23 1/2 22 3/4	C C		A A	N	122427
17 3/8	23 1/8	1 1/4	FORD		VT	C	2	12	GR GR	2 1/2 1 5/8	22 3/4 22 3/4	3/8 C		A A	N	122536
17 3/8	23 1/8	1 1/4	FORD		VT	C	2	12	GR GR	2 9/16 2 9/16	22 7/8 22 7/8	C C		A A	N	128611
17 3/8	23 1/8	1 1/4	FORD		VT	C	2	12	BU GR	3 3/16 1 5/8	23 1/2 22 3/4	C C		A A	N	122454
17 3/8	23 1/8	1 1/4	FORD		VT	C	2	12	BU GR	3 3/16 1 5/8	23 1/2 22 3/4	C C		A A	N	122591
17 3/8	23 1/8	2	FORD		VT	C	3	12	BU GR	3 3/16 2 1/2	23 7/16 22 7/8	C C		A A	N	122428
17 3/8	23 1/8	2	FORD		VT	C	3	14	GR GR	2 7/8 2 7/8	22 11/16 22 11/16	C C		A A	N	124745
17 3/8	23 1/8	2	FORD		VT	C	3	12	BU GR	3 3/16 2 1/4	23 1/2 23	C C		A A	N	122393
17 3/8	23 1/8	2	FORD		VT	C	3	12	GR GR	2 1/2 2 1/2	22 7/8 22 7/8	C C		A A	N	122518
17 3/8	23 1/8	2	FORD		VT	C	3	12	BU GR	3 3/16 2 1/2	23 1/2 22 7/8	C C		A A	N	122593
17 3/8	23 1/8	2	FORD		VT	C	3	12	GR FR	2 1/2 2 1/16	22 7/8 22 7/8	C C		A A	N	128343
17 3/8	23 1/8	2	FORD		VT	C	3	12	BU FR	3 3/16 2 1/8	23 1/2 22 7/8	C C		A A	N	128615
17 3/8	24 3/16	1 1/4	FORD	FAIRLANE	VT	C	2	12	GR GR	2 3/4 2 3/4	23 7/8 23 7/8	3/16 3/16		A A	N	122587
17 3/8	24 3/16	2	FORD	FAIRLANE	VT	C	3	12	GR GR	2 3/4 2 3/4	23 7/8 23 7/8	C C		A A	N	122598
17 7/8	23 1/8	2	FORD		VT	C	3	12	BU GR	4 1/4 2 1/4	25 3/4 23 5/8	C C		A A	N	128332
17 7/8	23 5/8	1 1/4	FORD		VT	C	2	12	BU GR	4 1/4 2 1/4	25 3/4 23 5/8	1/4 C		A A	N	128331
17 7/8	24 3/16	1 1/4	FORD		VT	C	2	12	BU GR	4 1/4 2 1/4	25 3/4 23 5/8	C C		A A	N	122228
17 7/8	24 3/16	1 1/4	FORD		VT	C	2	12	BU GR	4 1/4 2 1/4	25 3/4 23 5/8	C C		A A	N	122288
17 7/8	24 3/16	2	FORD		VT	C	3	12	BU GR	4 1/4 2 1/4	25 3/4 23 5/8	C C		A A	N	122246

Vista-Pro Automotive - Core Catalog

(Cores Sorted by Application)

Height	Width	Depth	Application	Description	Fln Type	Fln Matl	Rows	FPI	BH/TH Type	BH/TH Width	BH/TH Length	BH/TH OHF	BH/TH Bolts	BH/TH Shape	Hdr Support	Part #
FORD (Cont)																
17 7/8	24 3/16	2	FORD		VT	C	3	12	BU GR	4 1/4 2 1/4	25 3/4 23 5/8	C C		A A	N	122436
17 7/8	26 3/8	2 5/8	FORD		VT	C	4	12	BU GR	5 3	27 3/8 26 13/16	C C		A A	N	128466
18	18 1/8	1 1/4	FORD	RANGER	VT	C	2	12	GR GR	2 2 1/2	18 7/8 18 7/8	C C		A A	N	122704
18	18 1/8	2	FORD	RANGER	VT	C	3	16	GR GR	2 7/8 2 7/8	18 7/8 18 7/8	3/8 3/8		A A	N	128546
18	23 5/8	1 1/2	FORD	LIGHT TRUCK	T	C	2	9	GR GR	2 1/2 2	23 3/4 23 3/4	C C		A A	N	263181
18	23 5/8	1 1/4	FORD		VT	C	2	13	GR GR	2 7/8 2	23 3/4 23 3/4	C C		A A	N	124925
18	23 5/8	1 1/4	FORD	LIGHT TRUCK	VT	C	2	16	GR GR	2 7/8 2 7/8	23 3/4 23 3/4	C C		A A	N	124718
18	23 5/8	1 1/4	FORD		VT	C	2	14	GR GR	2 1/2 2	23 3/4 23 3/4	C C		A A	N	122359
18	23 5/8	2	FORD		VT	C	3	12	BU GR	4 1/4 2 1/4	25 3/4 23 5/8	C C		A A	N	122403
18	23 5/8	2	FORD	TRUCK	VT	C	3	12	GR FR	2 11/16 2	23 3/4 23 5/8	C C		A A	N	124808
18	23 5/8	2	FORD		VT	C	3	12	GR GR	2 7/8 2	23 3/4 23 3/4	C C		A A	N	124814
18	23 5/8	2 5/8	FORD		VT	C	4	12	GR GR	2 7/8 2 7/8	23 3/4 23 3/4	C C		A A	N	128660
18	26 3/8	1 1/4	FORD		VT	C	2	12	BU GR	5 3	27 3/8 26 13/16	C C		A A	N	122370
18	26 3/8	2	FORD		VT	C	3	12	BU GR	5 3	27 3/8 26 13/16	C C		A A	N	122372
18	26 7/16	2 1/4	FORD	LIGHT TRUCK	T	C	3	11	BU GR	5 3	27 3/8 26 13/16	C C		A A	N	262840
18 1/8	25 5/16	2	FORD		VT	C	3	12	BU GR	4 1/4 2 1/4	25 3/4 25	C C		A A	N	128604
18 1/4	20 3/8	2	FORD		VT	C	3	12	BU GR	4 5/8 2 1/4	21 1/2 20 1/4	C C		A A	N	122216
18 1/4	20 3/8	2	FORD	TBIRD CORE	VT	C	3	12	BU GR	4 5/8 2 5/8	21 1/2 20 1/4	C C		A A	N	122248
18 1/4	25 7/8	2	FORD		VT	C	3	12	GR GR	3 3	26 13/16 26 13/16	C C		A A	N	124658
18 1/4	26 3/8	2 5/8	FORD		VT	C	4	12	GR GR	3 3	26 13/16 26 13/16	C C		A A	N	128489
18 3/8	18 11/16	2	FORD		VT	C	3	12	BU GR	4 2 1/4	19 1/2 18 1/2	C C		A A	N	122302
18 3/8	19 3/8	1 7/8	FORD	LIGHT TRUCK	X	C	2	7	GR GR	6 2 1/2	19 19	FF C		A A	N	262885
18 7/16	23 5/8	2	FORD		VT	C	3	12	BU GR	4 1/4 2 1/4	25 3/4 23 5/8	C C		A A	N	122264
18 7/16	25 7/8	2	FORD		VT	C	3	12	BU GR	4 3/4 2 1/2	27 1/2 26 1/4	C C		A A	N	122274
18 1/2	18 11/16	1 1/4	FORD	PICKUP	VT	C	2	12	GR GR	2 9/16 2	18 1/4 18 1/2	C C		A A	N	122508
18 1/2	18 11/16	2	FORD		VT	C	3	12	GR FR	2 9/16 2	18 1/4 18 1/2	C C		A A	N	122509
18 5/8	18 9/16	2 1/4	FORD		T	C	3	10	BU GR	4 2 1/4	19 1/2 18 1/2	C C		A A	N	263254

Vista-Pro Automotive - Core Catalog

(Cores Sorted by Application)

Height	Width	Depth	Application	Description	Fln Type	Fln Matl	Rows	FPI	BH/TH Type	BH/TH Width	BH/TH Length	BH/TH OHF	BH/TH Bolts	BH/TH Shape	Hdr Support	Part #
FORD (Cont)																
18 5/8	18 11/16	2	FORD		VT	C	3	12	BU GR	4 2 1/4	19 1/2 18 1/2	C C		A A	N	122328
18 11/16	25 5/8	2 1/4	FORD		X	C	3	9	GR FR	4 3/8 2 1/4	25 1/2 25 1/2	1/4 C		A A	N	265928
18 3/4	26 3/8	2	FORD	PICKUP	VT	C	3	12	GR GR	3 3	26 13/16 26 13/16	C C		A A	N	128476
19	22	2	FORD		VT	C	3	12	BU GR	4 1/8 2 9/16	23 21 7/8	C C		A A	N	122318
19 1/16	26 1/4	3	FORD		X	C	4	10	GR GR	3 1/4 3 1/4	26 3/8 26 3/8	C C		A A	N	265926
19 1/8	19 1/4	2 5/8	FORD		VT	C	4	12	FR FR	2 3/4 2 3/4	19 1/8 19 1/8	C C		0 A	N	128401
19 1/8	19 1/4	2 5/8	FORD		VT	C	4	12	GR GR	2 3/4 2 3/4	19 1/8 19 1/8	C C		A A	N	128488
19 1/8	20 13/16	3	FORD	LIGHT TRUCK	T	C	4	8		3 3	21 21	C C		0 0	N	261629
19 1/4	19 1/4	2	FORD		VT	C	3	12	GR GR	2 1/2 2 1/2	19 1/8 19 1/8	C C		A A	N	124593
19 1/4	25 7/8	1 1/4	FORD	PICKUP	VT	C	2	13	GR GR	3 3	26 26	C C		A A	N	124952
19 1/4	25 7/8	1 1/4	FORD		VT	C	2	16	GR GR	3 3	26 13/16 26 13/16	C C		A A	N	128976
19 1/4	25 7/8	2	FORD		VT	C	3	12	GR GR	3 3	26 13/16 26 13/16	C C		A A	N	124541
19 1/4	25 7/8	2	FORD		VT	C	3	16	GR GR	3 3	26 13/16 26 13/16	C C		A A	N	128978
19 1/4	25 7/8	2	FORD		VT	C	3	12	GR GR	3 3	26 26	C C		A A	N	124719
19 1/4	25 7/8	2 5/8	FORD		VT	C	4	12	GR GR	3 3	26 13/16 26 13/16	C C		A A	N	124815
19 1/4	26 1/4	1 3/4	FORD	TRUCK	R	C	3	10	GR GR	3 3	26 13/16 26 13/16	C C		A A	N	226887
19 7/16	19 13/16	2	FORD		VT	C	3	12	BU GR	4 5/8 2 1/2	21 1/2 20	1/4 C		A A	N	122224
19 1/2	19 1/4	2	FORD		VT	C	3	12	GR GR	2 1/4 2 1/4	19 3/8 19 3/8	C C		A A	N	128669
19 1/2	19 11/16	2 1/4	FORD		T	C	3	10	GR GR	4 2 1/4	20 20	C C		A A	N	264043
19 1/2	19 11/16	3	FORD		T	C	4	10	GR FR	4 3	20 20	C C		A A	N	260601
19 1/2	19 13/16	2	FORD		VT	C	3	12	GR GR	4 2 1/4	20 20	1/8 C		A A	N	122330
19 5/8	8 13/16	1 1/4	FORD		VT	C	2	14	GR GR	1 7/8 1 7/8	9 7/16 9 7/16	C C		A A	N	124906
19 11/16	18 3/4	1 3/4	FORD		R	C	3	8		4 3/8 2 5/16	17 1/2 18 1/2	1/4 1/4		0 0	N	265921
19 3/4	18 3/4	1 7/8	FORD	LIGHT TRUCK	X	C	2	6	SQ SQ	4 3/8 2 3/8	19 19	C 1/4		A A	N	262829
19 13/16	19 1/8	2 1/4	FORD		T	C	3	8		4 2 1/4	18 18 3/16	FF C		0 0	N	265409
20	17 5/8	2	FORD		VT	C	3	12	GR GR	2 5/8 2 5/8	17 7/16 17 7/16	C C		A A	N	122503
20	23 5/8	2 1/4	FORD	LIGHT TRUCK	T	C	3	8	BU GR	4 3/4 3	24 1/2 24	C C		A A	N	266093

Vista-Pro Automotive - Core Catalog

(Cores Sorted by Application)

Height	Width	Depth	Application	Description	Fin Type	Fin Matl	Rows	FPI	BH/TH Type	BH/TH Width	BH/TH Length	BH/TH OHF	BH/TH Bolts	BH/TH Shape	Hdr Support	Part #
FORD (Cont)																
20	23 5/8	1 1/4	FORD		VT	C	2	12	BU GR	4 3/4 3	24 1/2 24	C C		A A	N	128600
20	23 5/8	2 5/8	FORD		VT	C	4	12	BU GR	4 3/4 3	24 5/8 24 1/8	C C		A A	N	122424
20	24 3/16	2	FORD		VT	C	3	12	BU GR	4 3/4 3	24 1/2 24	C C		A A	N	122251
20	24 3/16	2	FORD		VT	C	3	12	BU GR	4 3/4 3	24 5/8 24 1/8	C C		A A	N	122256
20 5/16	20 7/8	2	FORD		VT	C	3	12	GR GR	3 3	21 21	7/16 7/16		A A	N	122304
20 5/16	22 1/2	2 1/4	FORD	LIGHT TRUCK	T	C	3	8	BU GR	5 3/8 3	23 22 1/2	C C		A A	N	260713
20 5/16	22 1/2	2 1/4	FORD	LIGHT TRUCK	T	C	3	8	BU GR	5 3/8 3	23 22 1/2	C C		A A	N	264055
20 5/16	22 9/16	2	FORD		VT	C	3	12	BU GR	5 3/8 3	23 22 1/2	C C		A A	N	122334
20 5/16	22 9/16	2	FORD		VT	C	3	12	BU GR	5 3/8 3	23 22 1/2	C C		A A	N	122212
20 5/16	22 9/16	2 5/8	FORD		VT	C	4	12	BU GR	5 3/8 3	23 22 1/2	C C		A A	N	122420
20 3/8	25 7/8	1 1/4	FORD		VT	C	2	14	GR GR	3 3	26 13/16 26 13/16	C C		A A	N	124926
20 3/8	25 7/8	2	FORD		VT	C	3	12	GR GR	3 3	26 13/16 26 13/16	C C		A A	N	124927
20 9/16	17 5/8	1 1/4	FORD		VT	C	2	12	GR GR	2 1/4 2 1/4	17 7/16 17 7/16	C C		A A	N	122289
20 9/16	17 5/8	2	FORD		VT	C	3	12	GR GR	2 1/4 2 1/4	17 7/16 17 7/16	C C		A A	N	122311
20 3/4	26 3/8	2	FORD		VT	C	3	12	BU GR	5 3	27 3/8 26 13/16	C C		A A	N	122349
20 7/8	20 5/8	2 7/8	FORD		S	C	5	8		3 3	21 21	C C		0 0	N	266335
21 1/8	30 1/4	2	FORD	PICKUP	VT	C	3	12	GR GR	3 3	30 1/2 30 1/2	1/4 1/4		A A	N	124781
21 1/8	30 1/4	2 5/8	FORD		VT	C	4	12	GR GR	3 3	30 1/2 30 1/2	C C		A A	N	128131
21 3/8	21 3/8	2 1/4	FORD		T	C	3	8	GR GR	3 3	21 21	7/16 7/16		A A	N	260799
21 5/8	19 13/16	2	FORD		VT	C	3	12	GR GR	2 3/4 2 3/4	20 3/4 20 3/4	C C		A A	N	128108
21 5/8	20 13/16	2 1/4	FORD		T	C	3	8	GR GR	3 3	21 21	1/4 1/4		A A	N	261925
21 5/8	20 7/8	2	FORD		VT	C	3	12	GR GR	3 3	21 21	1/4 1/4		A A	N	122324
21 5/8	20 7/8	2 5/8	FORD		VT	C	4	12	GR GR	3 3	21 21	C C		A A	N	122333
21 3/4	18 1/8	1 1/4	FORD		VT	C	2	14	GR GR	2 13/16 3 3/8	18 7/8 18 7/8	1 1		A A	N	124534
21 3/4	18 1/8	2	FORD		VT	C	3	12	GR GR	3 3/8 2 13/16	18 7/8 18 7/8	3/8		A A	N	124535
21 3/4	18 1/8	2 5/8	FORD		VT	C	4	12	GR GR	2 13/16 3 3/8	18 7/8 18 7/8	C C		A A	N	122611
22 1/8	16 7/8	2 7/8	FORD		S	C	5	8	GR GR	5 3/4 3 1/16	17 1/8 17 3/8	C C		A A	N	265934

Vista-Pro Automotive - Core Catalog

(Cores Sorted by Application)

Height	Width	Depth	Application	Description	Fln Type	Fln Matl	Rows	FPI	BH/TH Type	BH/TH Width	BH/TH Length	BH/TH OHF	BH/TH Bolts	BH/TH Shape	Hdr Support	Part #
FORD (Cont)																
22 1/8	18	2 1/4	FORD		T	C	3	8	GR	4	17 3/16	FF		A	N	265410
									GR	2 1/4	17 3/16	C		A		
22 1/4	18 1/8	1 3/4	FORD		R	C	3	7	SQ	4 3/8	17 1/8	1/4		0	N	265922
									SQ	2 5/16	17 3/8	1/4		A		
22 1/4	18 1/8	2 3/8	FORD	LIGHT TRUCK	S	C	4	8	GR	4 3/8	17 7/8	1/4		A	N	265933
									GR	2 13/16	17 7/8	C		A		
22 7/16	17 5/8	1 1/4	FORD		VT	C	2	12	GR	2 5/8	17 1/2	C		A	N	122348
									GR	2 5/8	17 1/2	C		A		
22 7/16	17 5/8	2	FORD		VT	C	3	12	GR	2 1/4	17 7/16	C		A	N	122338
									GR	2 1/4	17 7/16	C		A		
22 7/16	17 5/8	2	FORD		VT	C	3	12	GR	2 5/8	17 1/2	C		A	N	122350
									GR	2 5/8	17 1/2	C		A		
22 7/16	19 11/16	3	FORD		T	C	4	8		6 1/4	19 5/8	1/4		0	N	261289
										3	19 5/8	C		0		
22 1/2	17 5/8	2 5/8	FORD		VT	C	4	12	GR	2 3/4	17 7/16	C		A	N	128613
									GR	2 3/4	17 7/16	C		A		
22 1/2	19 1/4	2	FORD		VT	C	3	14	GR	2 7/8	19	C		A	N	124645
									GR	2 7/8	19	C		A		
22 1/2	20 7/8	2	FORD		VT	C	3	12	GR	3	21	1/4		A	N	122322
									GR	3	21	1/4		A		
22 3/4	16 7/8	3	FORD		T	C	4	9	GR	7 1/16	17	1/4		A	N	260348
									GR	3	17	C		A		
23	15 5/8	3	FORD		X	C	4	8	GR	8 1/4	15 3/4	1 1/4		A	N	265924
									GR	3	15 3/4	C		A		
23 1/4	17 5/8	2	FORD		VT	C	3	12	GR	2 1/2	17 7/16	C		A	N	128607
									GR	2 1/2	17 7/16	C		A		
23 1/4	26 3/8	2	FORD		VT	C	3	12	BU	5	27 3/8	C		A	N	122524
									GR	3	26 13/16	C		A		
23 1/4	27 1/2	1 1/4	FORD		VT	C	2	12	GR	4 1/8	27 7/8	1 3/4		A	N	128217
									GR	2 3/4	27 7/8	5/16		A		
23 1/4	27 1/2	2	FORD		VT	C	3	14	GR	2 7/8	27 7/8	C		A	N	128127
									GR	2 7/8	27 7/8	C		A		
23 5/16	17 5/8	2	FORD		VT	C	3	12	GR	2 5/8	17 1/2	C		A	N	122366
									GR	2 5/8	17 1/2	C		A		
23 5/8	31 3/8	2	FORD		VT	C	3	16	GR	3 5/8	31 1/4	3/8		A	N	128564
									GR	3 5/8	31 1/4	3/8		A		
23 5/8	31 3/8	2	FORD		VT	C	3	16	GR	3 5/8	31 1/4	1/4		A	N	128261
									GR	3 5/8	31 1/4	1/4		A		
23 5/8	31 3/8	2 5/8	FORD		VT	C	4	14	GR	3 5/8	31 1/4	3/8		A	N	128764
									GR	3 5/8	31 1/4	3/8		A		
23 5/8	31 3/8	3 1/4	FORD		VT	C	5	12	GR	3 5/8	31 1/4	C		A	N	128589
									GR	3 5/8	31 1/4	C		A		
24	17 5/8	2	FORD		VT	C	3	12	GR	2 1/2	17 1/2	C		A	N	122278
									GR	2 1/2	17 1/2	C		A		
24	17 5/8	2	FORD		VT	C	3	12	GR	2 5/8	17 1/2	C		A	N	122404
									GR	2 5/8	17 1/2	C		A		
24	23 5/8	2 5/8	FORD		VT	C	4	12	GR	3	24 1/8	C		A	N	128462
									GR	3	24 1/8	C		A		
24 1/4	25 5/16	2	FORD		VT	C	3	12	GR	3	26 13/16	C		A	N	122507
									GR	3	26 13/16	C		A		
24 1/4	26 1/4	2 3/8	FORD		R	C	4	11		4 1/4	26 1/4	C		0	C	265821
										3	26 13/16	C		0		
24 1/4	26 1/4	2 7/8	FORD		R	C	5	11	GR	4 1/4	26 1/4	7/8		A	C	275959
									GR	3	26 13/16	C		A		

Vista-Pro Automotive - Core Catalog

(Cores Sorted by Application)

Height	Width	Depth	Application	Description	Fln Type	Fln Matl	Rows	FPI	BH/TH Type	BH/TH Width	BH/TH Length	BH/TH OHF	BH/TH Bolts	BH/TH Shape	Hdr Support	Part #
FORD (Cont)																
24 1/4	26 3/8	2	FORD	PICKUP	VT	C	3	12	GR	4 1/4	26 1/4	C		A	N	124766
									GR	3	26 13/16	C		A	N	128473
24 1/4	26 3/8	2	FORD		VT	C	3	12	GR	3	26 13/16	C		A	N	128473
									GR	3	26 13/16	C		A	N	128473
24 1/4	26 3/8	2 5/8	FORD	PICKUP	VT	C	4	12	GR	4 1/4	26 1/4	C		A	N	124767
									GR	3	26 13/16	C		A	N	124767
24 1/4	26 3/8	2 5/8	FORD		VT	C	4	12	GR	3	26 13/16	C		A	N	128653
									GR	3	26 13/16	C		A	N	128653
24 5/16	26 3/8	2	FORD		VT	C	3	12	BU	5	27 3/8	C		A	N	128743
									GR	3	26 13/16	C		A	N	128743
24 5/16	26 3/8	2	FORD		VT	C	3	12	BU	5	27 3/8	C		A	N	128659
									GR	4 1/4	26 1/4	C		A	N	128659
24 5/16	26 3/8	2 5/8	FORD		VT	C	4	12	BU	5	27 3/8	C		A	N	128274
									GR	3	26 13/16	C		A	N	128274
24 5/16	26 3/8	2 5/8	FORD		VT	C	4	12	BU	5	27 3/8	C		A	N	128654
									GR	4 1/4	26 1/4	3/16		A	N	128654
24 3/8	26 1/4	2 3/8	FORD	PICK UP	R	C	4	9	GR	4 1/4	26 1/4	1/2		A	C	289747
									GR	3	26 13/16	1/2		A	C	289747
24 1/2	17 5/8	1 1/4	FORD	GRANADA	VT	C	2	14	GR	2 13/16	18 7/8	1/4		A	N	122679
									GR	2 13/16	18 7/8	1/4		A	N	122679
24 1/2	18 1/8	1 1/4	FORD		VT	C	2	14	GR	2	18 7/8	5/16		A	N	124983
									GR	2 1/2	18 7/8	5/16		A	N	124983
24 1/2	18 1/8	1 1/4	FORD		VT	C	2	13	GR	2 13/16	18 7/8	5/16		A	N	124741
									GR	2 13/16	18 7/8	5/16		A	N	124741
24 1/2	18 1/8	2 5/8	FORD		VT	C	4	12	GR	3 3/8	18 7/8	3/4		A	N	122609
									GR	2 13/16	18 7/8	C		A	N	122609
24 1/2	18 1/8	2 5/8	FORD		VT	C	4	12	GR	2 7/8	18 7/8	C		A	N	122627
									GR	2 7/8	18 7/8	C		A	N	122627
24 1/2	18 3/16	1 9/16	FORD		VE	C	3	16	GR	2	18 7/8	C		A	N	128721
									GR	2 1/2	18 7/8	3/8		A	N	128721
25	17 5/8	2	FORD		VT	C	3	12	GR	2 5/8	17 1/2	C		A	N	122430
									GR	2 5/8	17 1/2	C		A	N	122430
25	19 1/4	1 1/4	FORD		VT	C	2	12	GR	2 7/8	19	C		A	N	122541
									GR	2 7/8	19	C		A	N	122541
25	19 1/4	2 5/8	FORD		VT	C	4	12	GR	2 7/8	19	C		A	N	122570
									GR	2 7/8	19	C		A	N	122570
26	18 1/8	1 1/4	FORD		VT	C	2	14	GR	3 3/8	18 7/8	1 7/16		A	N	124502
									GR	2 13/16	18 7/8	1 7/16		A	N	124502
26	18 1/8	2	FORD		VT	C	3	12	GR	2 13/16	18 7/8	1/4		A	N	124511
									GR	3 3/8	18 7/8	3/4		A	N	124511
26	18 1/8	2 5/8	FORD		VT	C	4	12	GR	2 13/16	18 7/8	C		A	N	122610
									GR	3 3/8	18 7/8	C		A	N	122610
28	18 1/8	1 1/4	FORD		VT	C	2	12	GR	2 13/16	18 7/8	7/16		A	N	124642
									GR	3 3/8	18 7/8	7/16		A	N	124642
28	18 1/8	2	FORD		VT	C	3	14	GR	2 13/16	18 7/8	5/16		A	N	124643
									GR	3 3/8	18 7/8	5/16		A	N	124643
28	18 1/8	2	FORD		VT	C	3	16	GR	2 13/16	18 7/8	5/16		A	N	124944
									GR	2 13/16	18 7/8	5/16		A	N	124944
28	18 1/8	2 5/8	FORD		VT	C	4	12	GR	2 13/16	18 7/8	C		A	N	122616
									GR	3 3/8	18 7/8	C		A	N	122616
28	18 1/8	2 5/8	FORD		VT	C	4	12	GR	2 13/16	18 7/8	C		A	N	122634
									GR	2 13/16	18 7/8	C		A	N	122634
29	27 1/2	2	FORD		VT	C	3	14	GR	2 7/8	27 7/8	1/2		A	N	128138
									GR	2 7/8	27 7/8	1/2		A	N	128138

Vista-Pro Automotive - Core Catalog

(Cores Sorted by Application)

Height	Width	Depth	Application	Description	Fin Type	Fin Matl	Rows	FPI	BH / TH Type	BH / TH Width	BH / TH Length	BH / TH OHF	BH / TH Bolts	BH / TH Shape	Hdr Support	Part #
FORD (Cont)																
29	27 1/2	2 5/8	FORD		VT	C	4	12	GR	2 7/8	27 7/8	C		A	N	128736
									GR	2 7/8	27 7/8	C		A		
29 1/2	18 1/8	1 1/4	FORD		VT	C	2	12	GR	2 13/16	18 7/8	C		A	N	124673
									GR	3 3/8	18 7/8	C		A		
29 1/2	18 1/8	2	FORD		VT	C	3	13	GR	2 13/16	18 7/8	5/16		A	N	124674
									GR	3 3/8	18 7/8	5/16		A		
30 1/4	25 7/8	2	FORD		VT	C	3	12	GR	3	26 13/16	C		A	N	128748
									GR	3	26 13/16	C		A		
30 1/4	25 7/8	2 5/8	FORD		VT	C	4	12	GR	3	26 13/16	C		A	N	128749
									GR	3	26 13/16	C		A		
FORD POWER PRODUCTS																
17 1/2	16 1/4	2 15/16	FORD POWER PRODUCTS	STATIONARY	Z	C	4	7	GR	3 3/8	16 1/2	C		A	N	287512
									GR	3 3/8	16 1/2	C		A		
17 1/2	16 1/4	3	FORD POWER PRODUCTS		X	C	4	6	GR	3 3/8	16 1/2	C		A	N	288000
									GR	3 3/8	16 1/2	C		A		
17 1/2	16 5/16	2 1/4	FORD POWER PRODUCTS	STATIONARY	T	C	3	6	GR	3 3/8	16 1/2	C		A	N	265503
									GR	3 3/8	16 1/2	C		A		
17 3/4	18 1/8	3	FORD POWER PRODUCTS	5500 POWER UNIT	X	C	4	8	GR	4	18 3/8	3/16		A	N	281649
									GR	4	18 3/8	3/16		A		
19 3/4	19 3/8	2 7/8	FORD POWER PRODUCTS	D7JL-8005-AA	S	C	5	10	GR	4 1/4	19 5/8	C		A	N	229046
									GR	4 1/4	19 5/8	C		A		
20 1/4	20 5/8	2 7/8	FORD POWER PRODUCTS		R	C	5	8	CR	7 1/4	17 3/4	3/8		A	N	226454
									CR	4 1/2	21 1/2	3/16		A		
20 1/4	21 3/8	3	FORD POWER PRODUCTS		T	C	4	10	CR	5 1/4	21 5/8	1/4		A	N	223135
									CR	4 1/4	21 5/8	1/4		A		
20 3/8	19 3/8	3	FORD POWER PRODUCTS	403	X	C	4	8	GR	3 7/8	20	1/4		A	N	221502
									GR	3 7/8	20	1/4		A		
20 3/8	19 1/2	3	FORD POWER PRODUCTS		B	C	4	7	GR	3 7/8	20	3/16		A	N	229514
									GR	3 7/8	20	3/16		A		
20 1/2	19 3/8	2 15/16	FORD POWER PRODUCTS		Z	C	4	10	GR	3 7/8	20	3/16		A	N	286883
									GR	3 7/8	20	3/16		A		
23 1/4	22 1/2	3	FORD POWER PRODUCTS		X	C	4	11	GR	3 1/2	22 1/2	C		A	N	289159
									GR	3 1/2	22 1/2	C		A		
29 1/2	21 15/16	3	FORD POWER PRODUCTS	POWER UNIT	T	C	4	10	GR	3 1/2	22 1/2	C		A	C	223161
									GR	3 1/2	22 1/2	C		A		
FORD TRACTOR																
14 3/4	13 3/4	2 1/4	FORD TRACTOR	ENGLISH DIESEL BTM HDR OFFSET	X	C	3	8	SQ	2 1/2	14 1/4	C		A	N	287947
									SQ	2 1/2	16 1/4	C		A		
14 3/4	14 1/16	2 1/4	FORD TRACTOR	ENGLISH DIESEL BTM HDR OFFSET	T	C	3	9	GR	2 1/2	14 1/4	C		A	N	262820
									GR	2 1/2	16 1/4	C		A		
14 3/4	14 1/16	2 1/4	FORD TRACTOR	DEXTER DIESEL BTM HDR OFFSET	T	C	3	8	GR	2 1/2	14 1/4	C		A	N	276804
									GR	2 1/2	16 1/4	C		A		
16	17 7/16	2 1/4	FORD TRACTOR	3000, 4000	T	C	3	8	GR	3 5/8	18 1/8	1/2		A	N	223130
									GR	2 7/8	18 1/8	1/2		A		
16	17 7/16	2 1/4	FORD TRACTOR	3000, 4000	T	C	3	8	GR	4	17 3/4	1/2		A	N	223147
									GR	2 7/8	17 3/4	1/4		A		
16	17 7/16	2 1/4	FORD TRACTOR	3000, 4000	T	C	3	7	GR	3 1/2	17 3/4	1/2		A	N	223628
									GR	2 7/8	17 3/4	1/4		A		
16	17 1/2	2 1/4	FORD TRACTOR		X	C	3	6	GR	3 5/8	18 1/8	1/2		A	N	221808
									GR	2 7/8	18 1/8	1/2		A		
16	17 1/2	2 1/4	FORD TRACTOR	3000	X	C	3	6	GR	4	17 3/4	1/2		A	N	221822
									GR	2 7/8	17 3/4	1/2		A		
16 3/4	13 3/4	2 3/16	FORD TRACTOR	DEXTER DIESEL BTM HDR OFFSET	Z	C	3	9	GR	2 1/2	14 1/4	C		A	N	225432
									GR	2 1/2	16 1/4	C		A		

Vista-Pro Automotive - Core Catalog

(Cores Sorted by Application)

Height	Width	Depth	Application	Description	Fin Type	Fin Matl	Rows	FPI	BH/TH Type	BH/TH Width	BH/TH Length	BH/TH OHF	BH/TH Bolts	BH/TH Shape	Hdr Support	Part #
FORD TRACTOR (Cont)																
16 3/4	14 1/16	2 1/4	FORD TRACTOR	DEXTER DIESEL BTM HDR OFFSET	T	C	3	9	GR GR	2 1/2 2 1/2	14 1/4 16 1/4	C C		A A	N	223164
17 1/4	15	2 3/16	FORD TRACTOR	8N, 9N, 2N DIAMOND T/HDR	Z	C	3	7	SH FR	4 3/4 2 1/4	15 3/4 15 3/4	1 3/8 C		SP A	N	225434
17 1/4	15 5/8	1 7/8	FORD TRACTOR	8N DIAMOND T/HDR	X	C	2	7	SH GR	4 3/4 2 1/4	15 3/4 15 3/4	1 5/16 C		SP A	N	221815
17 1/4	15 5/8	2 3/16	FORD TRACTOR	20, 30 DIAMOND T/HDR	Z	C	3	7	SH GR	4 1/4 2 3/8	15 3/4 15 3/4	C C		SP A	N	225440
17 1/4	15 5/8	2 3/16	FORD TRACTOR		Z	C	3	9	SH FR	7 1/2 2 1/4	15 3/4 15 3/4	1/4 C		SP A	N	225442
17 1/4	15 5/8	2 1/4	FORD TRACTOR	DIAMOND T/HDR	X	C	3	8	SH FR	4 1/4 2 3/8	15 3/4 15 3/4	C C		SP A	N	221503
17 1/4	15 5/8	2 1/4	FORD TRACTOR	DIAMOND T/HDR	X	C	3	9	SH FR	4 1/4 2 3/8	15 3/4 15 3/4	C C		SP A	N	221809
17 1/4	15 3/4	1 1/2	FORD TRACTOR	8N DIAMOND T/HDR	T	C	2	7	SH GR	4 3/4 2 1/4	15 3/4 15 3/4	C C		SP A	N	223131
17 1/4	15 3/4	2 1/4	FORD TRACTOR	20, 30 DIAMOND T/HDR	T	C	3	6	SH GR	4 1/8 2 3/8	15 3/4 15 3/4	C C		SP A	N	223138
17 1/4	15 3/4	2 1/4	FORD TRACTOR		T	C	3	7	SH FR	7 1/2 2 1/4	15 3/4 15 3/4	1/8 C		SP A	N	223142
17 1/4	15 3/4	2 1/4	FORD TRACTOR	2N, 8N, 9N DIAMOND T/HDR	T	C	3	6	SH FR	4 3/4 2 5/16	15 3/4 15 3/4	C C		SP A	N	223157
17 5/16	15 5/8	2 3/8	FORD TRACTOR	L450 SKIDDER 9619994	S	C	4	9	GR GR	2 5/8 2 5/8	15 11/16 15 11/16	C C		A A	N	229047
17 1/2	16 1/4	2 3/16	FORD TRACTOR	NAA600, 700, 800, 900 BKT T/HDR	Z	C	3	7	BU GR	5 7/8 2 3/8	17 16 1/2	1/2 1/8		A A	N	225443
17 1/2	16 1/4	2 1/4	FORD TRACTOR	NAA-NAB-600-800,8005D BKT T/HDR	X	C	3	8	BU GR	5 7/8 2 3/8	17 16 1/2	7/16 C		A A	N	288402
17 1/2	16 1/4	3	FORD TRACTOR	TRACTOR	X	C	4	6	GR GR	3 3/8 3 3/8	16 1/2 16 1/2	C C		A A	N	266070
17 1/2	16 5/16	2 1/4	FORD TRACTOR	NAA, NAB, JUBILEE BKT T/HDR	T	C	3	7	BU FR	5 7/8 2 3/8	17 16 1/2	1/4 C		A A	N	223144
17 5/8	17 7/16	2 1/4	FORD TRACTOR		T	C	3	7	GR GR	4 2 7/8	17 3/4 17 3/4	1/2 1/2		A A	N	223179
17 5/8	17 7/16	2 1/4	FORD TRACTOR	5000 DIESEL	T	C	3	7	GR GR	3 7/8 2 7/8	18 18	1/8 C		A A	N	223186
17 5/8	17 1/2	2 1/4	FORD TRACTOR	5000 DIESEL	X	C	3	10	GR GR	4 2 7/8	17 3/4 17 3/4	1 3/8 C		A A	N	221785
17 5/8	17 1/2	3	FORD TRACTOR	5000 DIESEL	X	C	4	10	GR SQ	4 2 7/8	17 3/4 17 3/4	C C		A A	N	281827
17 3/4	16 7/8	2 1/4	FORD TRACTOR		X	C	3	9	GR GR	3 9/16 2 13/16	18 1/16 18 1/16	1 1/8 1/4		A A	N	221504
17 3/4	16 7/8	2 3/8	FORD TRACTOR		S	C	4	9	GR GR	3 9/16 2 13/16	18 1/16 18 1/16	1 1/8 1/4		A A	N	229011
17 3/4	18	3 3/4	FORD TRACTOR		T	C	5	8	GR GR	4 4	18 3/8 18 3/8	C C		A A	N	223187
17 3/4	18 1/8	2 7/8	FORD TRACTOR	L550 SKIDDER 9615903	S	C	5	9	GR FR	4 3	18 3/8 18 3/8	1/8 C		A A	N	229048
17 3/4	18 1/8	3 3/4	FORD TRACTOR	7000 TRACTOR	X	C	5	8	GR GR	4 4	18 3/8 18 3/8	3/16 3/16		A A	N	221518
17 3/4	18 1/8	3 3/4	FORD TRACTOR		X	C	5	8	GR GR	4 4	18 3/8 18 3/8	C C		A A	N	289467
18 1/4	18 1/8	2 7/8	FORD TRACTOR	285 FERGUSON	S	C	5	7	GR GR	4 3 1/8	18 1/2 18 1/2	C C		A A	N	229012

Vista-Pro Automotive - Core Catalog

(Cores Sorted by Application)

Height	Width	Depth	Application	Description	Fin Type	Fin Matl	Rows	FPI	BH / TH Type	BH / TH Width	BH / TH Length	BH / TH OHF	BH / TH Bolts	BH / TH Shape	Hdr Support	Part #
FORD TRACTOR (Cont)																
18 3/8	18 1/8	2 1/4	FORD TRACTOR	275 MASSEY FERGUSON	X	C	3	9	GR	4	18 5/16	1 3/8		A	N	266249
									GR	2 1/2	18 1/2	C		A		
18 3/4	15 3/4	2 1/4	FORD TRACTOR	202 WORK BULL DIAMOND T/HDR	T	C	3	8	SH	4 1/8	15 3/4	C		SP	N	223171
									GR	2 3/8	15 3/4	C		A		
18 3/4	16 7/8	2 3/16	FORD TRACTOR	BRITISH DIESEL	Z	C	3	10	GR	2 7/8	17 1/4	C		A	N	288596
									GR	2 7/8	17 1/4	C		A		
18 3/4	16 7/8	2 1/4	FORD TRACTOR	BRITISH DIESEL	T	C	3	9	GR	2 7/8	17 1/8	3/16		A	N	263156
									GR	2 7/8	17 1/8	3/16		A		
18 3/4	16 7/8	2 1/4	FORD TRACTOR	MAJOR DIESEL	X	C	3	11	GR	2 7/8	17 1/8	3/16		A	N	287458
									GR	2 7/8	17 1/8	3/16		A		
19 1/8	15 3/4	2 1/4	FORD TRACTOR	3165	T	C	3	9	GR	4 1/2	15 3/4	C		A	N	223150
									GR	2 1/2	15 3/4	C		A		
19 1/2	15 3/16	2 1/4	FORD TRACTOR		T	C	3	8	GR	4 1/2	15 3/4	C		A	N	223151
									GR	2 1/2	15 3/4	C		A		
20 1/4	25 5/8	2 3/8	FORD TRACTOR	4750 89178	S	C	4	8	GR	4 1/4	26 5/8	1/4		A	N	229049
									GR	4 1/4	26 5/8	1/4		A		
20 1/2	20 5/8	2 15/16	FORD TRACTOR	COTTON PICKER	Z	C	4	8	GR	5	21 1/4	3/8		A	N	287688
									GR	4 1/4	21 1/4	3/8		A		
20 1/2	20 5/8	3 3/4	FORD TRACTOR		X	C	5	9	CR	7 1/4	17 3/4	3/8		A	N	265981
									CR	4 1/4	21 1/4	C		A		
20 1/2	20 13/16	3 3/4	FORD TRACTOR	COTTON PICKER	T	C	5	8	GR	5	21 1/4	3/8		A	N	223153
									GR	4 1/4	21 1/4	3/8		A		
20 3/4	18 1/8	2 7/8	FORD TRACTOR	L780 SKIDDER 9603478	S	C	5	8	GR	4	18 5/16	1/4		A	N	229050
									GR	4	18 5/16	1/4		A		
20 3/4	18 1/8	3	FORD TRACTOR	L785	X	C	4	9	GR	4	18 5/16	3/16		A	N	282972
									GR	4	18 5/16	3/16		A		
20 3/4	18 1/8	3 7/16	FORD TRACTOR	A755 E9NN-8005-BA	S	C	6	9	GR	4	18 5/8	C		A	N	229051
									GR	4	18 5/8	C		A		
21 1/4	18 1/8	3 3/4	FORD TRACTOR	BACKHOE	X	C	5	11	GR	4 1/8	18 1/2	C		A	N	286984
									GR	4 1/8	18 1/2	C		A		
21 1/2	23 5/8	2	FORD TRACTOR		VT	C	3	16	GR	3	24	C		A	N	128474
									GR	3	24	C		A		
24	19 3/8	2 15/16	FORD TRACTOR	8000	Z	C	4	9	GR	3 3/8	20	C		A	C	286764
									GR	3 3/8	20	C		A		
24	19 3/8	3 3/4	FORD TRACTOR	862	X	C	5	8	GR	4	20	C		A	C	282489
									GR	4	20	C		A		
24	19 11/16	3	FORD TRACTOR	8000	T	C	4	9	GR	3 3/8	19 7/8	C		A	C	272639
									GR	3 3/8	19 7/8	C		A		
24	19 11/16	3 3/4	FORD TRACTOR	862	T	C	5	8	GR	4	20	C		A	C	272640
									GR	4	20	C		A		
24	25	2 7/8	FORD TRACTOR	1495 9619855	S	C	5	7	GR	3 1/4	25 1/2	C		A	C	229052
									GR	3 1/4	25 1/2	C		A		
24	25	3	FORD TRACTOR		B	C	4	7	GR	3 1/4	25 1/2	C		A	C	229571
									GR	3 1/4	25 1/2	C		A		
24	25	3	FORD TRACTOR	SWATHER	X	C	4	6	GR	3 1/4	25 1/2	C		A	C	265846
									GR	3 1/4	25 1/2	C		A		
24 3/4	21 7/8	3 7/16	FORD TRACTOR	9700 3/8" RADIUS HDR	S	C	6	8	GR	4	22	C		A	C	229204
									GR	4	22	C		A		
24 3/4	21 7/8	3 3/4	FORD TRACTOR	8200	X	C	5	8	GR	4 1/2	22	C		A	C	282767
									GR	4 1/2	22	C		A		
24 3/4	21 15/16	3 3/4	FORD TRACTOR	A700	T	C	5	8	GR	4	22	C		A	C	223166
									GR	4	22	C		A		
26 3/8	25	2 7/8	FORD TRACTOR	495 COMBINE 594118	S	C	5	6	GR	3 1/4	25 5/8	C		A	C	229132
									GR	3 1/4	25 5/8	C		A		

Vista-Pro Automotive - Core Catalog

(Cores Sorted by Application)

Height	Width	Depth	Application	Description	Fln Type	Fln Matl	Rows	FPI	BH/TH Type	BH/TH Width	BH/TH Length	BH/TH OHF	BH/TH Bolts	BH/TH Shape	Hdr Support	Part #
FORD TRACTOR (Cont)																
26 3/8	25 1/2	3	FORD TRACTOR	COMBINE 495	B	C	4	6	GR	3 1/4	25 5/8	C		A	C	279850
									GR	3 1/4	25 5/8	C		A		
26 9/16	25 5/8	3 7/16	FORD TRACTOR	D6NN-8005-G	S	C	6	8	GR	4 1/4	26 1/4	C		A	C	229053
									GR	4 1/4	26 1/4	C		A		
26 9/16	25 5/8	3 3/4	FORD TRACTOR	8A66 WHEEL LOADER	X	C	5	8	GR	4 3/16	26 3/8	C		A	C	266215
									GR	4 3/16	26 3/8	C		A		
26 9/16	25 5/8	3 15/16	FORD TRACTOR	D6NN-8005-H	S	C	7	8	GR	4 1/4	26 1/4	C		A	C	229054
									GR	4 1/4	26 1/4	C		A		
30 1/2	28 3/4	4 7/16	FORD TRACTOR	TR85 COMBINE 616992 BRASS FINS	Z	B	6	6	GR	5 7/8	29 1/2	C		A	C	225478
									GR	5 7/8	29 1/2	C		A		
31 1/8	30	3 3/4	FORD TRACTOR	850, 875, 900	X	C	5	9	GR	4 7/8	31 1/2	C		A	C	221509
									GR	4 7/8	31 1/2	C		A		
35 1/2	31 1/4	3 15/16	FORD TRACTOR	900 9702126	S	C	7	9	GR	4 1/2	31 7/16	C		A	C	229059
									GR	4 1/2	31 7/16	C		A		
36	33 1/8	3 7/16	FORD TRACTOR	900 68720	S	C	6	9	GR	4 1/2	33 1/2	C		A	C	229060
									GR	4 1/2	33 1/2	C		A		
36 1/8	30	3 7/16	FORD TRACTOR		S	C	6	8	GR	4 7/8	31 1/2	C		A	C	229095
									GR	4 7/8	31 1/2	C		A		
38 3/4	28 3/4	5 3/16	FORD TRACTOR	609321 BRASS FINS	Z	B	7	6	GR	5 7/8	29 1/2	C		A	C	225489
									GR	5 7/8	29 1/2	C		A		
FORD TRUCK																
15 3/4	18 1/8	2	FORD TRUCK		VT	C	3	12	GR	2 7/16	18 1/4	C		A	N	124938
									GR	2 7/16	18 1/4	C		A		
18	23 3/4	1 7/8	FORD TRUCK		X	C	2	7	GR	2 5/8	23 3/4	C		A	N	288441
									GR	2	23 3/4	C		A		
18	26 1/4	1 3/4	FORD TRUCK	F500-600 BKT T/HDR 1 1/2" INL 8 1/2" RT	R	C	3	11	BU	5	27 3/8	1 9/16		A	N	226456
									GR	3	26 13/16	C		A		
18	26 1/4	2 3/8	FORD TRUCK	F700-750 BKT T/HDR 1 1/2" INL 8 1/2" RT	R	C	4	11	BU	5	27 3/8	1 5/16		A	N	226455
									GR	3	26 13/16	C		A		
18 1/2	18 11/16	1 1/4	FORD TRUCK		VT	C	2	12	GR	2 9/16	18 1/4	C		A	N	122551
									GR	1 3/4	18 1/4	C		A		
19 1/4	25 7/8	2	FORD TRUCK		VT	C	3	14	GR	3	26 13/16	C		A	N	122703
									GR	3	26 13/16	C		A		
19 1/2	26 3/8	1 1/4	FORD TRUCK		VT	C	2	13	GR	3	26 13/16	C		A	N	122588
									GR	3	26 13/16	C		A		
20	23 3/4	1 3/4	FORD TRUCK	F350-600 BKT T/HDR RD INL CTRD	R	C	3	7	BU	4 3/4	24 5/8	1 3/4		A	N	226457
									GR	3	24 1/8	C		A		
20	23 3/4	2 3/8	FORD TRUCK	F600 BKT T/HDR RD INL CTRD	R	C	4	8	BU	4 3/4	24 5/8	1 3/8		A	N	226458
									GR	3	24 1/8	C		A		
20	24 3/16	2 1/4	FORD TRUCK	F35-600 BKT T/HDR 1 1/2" INL CTRD	T	C	3	10	BU	4 3/4	24 5/8	C		A	N	261187
									GR	3	24 1/8	C		A		
20 1/8	21	3 3/4	FORD TRUCK	105 TNL CRP/HDRS	B	C	5	8	CR	5 1/4	21 1/4	1/4		A	N	268007
									CR	4 1/8	21 1/4	C		A		
20 1/8	24 3/16	2 1/4	FORD TRUCK	F350-600 BKT T/HDR 1 1/2" INL 8 1/2" RT	T	C	3	9	BU	4 3/4	24 5/8	1 3/8		A	N	274290
									GR	3	24 1/8	C		A		
20 1/4	22 1/2	1 3/4	FORD TRUCK		R	C	3	7	BU	5 3/8	22 7/8	C		A	N	281380
									GR	3	22 1/2	C		A		
20 1/4	22 1/2	1 3/4	FORD TRUCK		R	C	3	11	BU	5 3/8	22 7/8	1 11/16		A	N	282110
									GR	3	22 1/2	C		A		
20 1/4	22 1/2	2 1/4	FORD TRUCK		T	C	3	9	BU	5 1/4	22 7/8	C		A	N	223323
									GR	3	22 1/2	C		A		
20 5/16	22 1/2	3	FORD TRUCK	F500-600 BKT T/HDR 1 1/4" INL CTRD	T	C	4	10	BU	5 3/8	23	C		A	N	264056
									GR	3	22 1/2	C		A		

Vista-Pro Automotive - Core Catalog

(Cores Sorted by Application)

Height	Width	Depth	Application	Description	Fin Type	Fin Matl	Rows	FPI	BH/TH Type	BH/TH Width	BH/TH Length	BH/TH OHF	BH/TH Bolts	BH/TH Shape	Hdr Support	Part #
FORD TRUCK (Cont)																
20 3/8	26 3/8	1 1/4	FORD TRUCK		VT	C	2	14	GR	3	26	C		A	N	128142
									GR	3	26	C		A		
21 5/8	19 13/16	1 1/4	FORD TRUCK		VT	C	2	14	GR	2 3/4	20 3/4	1/4		A	N	124988
									GR	2 3/4	20 3/4	1/4		A		
21 5/8	20 13/16	2 1/4	FORD TRUCK	6 & 8	T	C	3	9	GR	3	21	1/8		A	N	271925
									GR	3	21	1/8		A		
21 5/8	20 13/16	3	FORD TRUCK	3/4 -2 TON	T	C	4	10	FR	3	21	C		A	N	223202
									FR	3	21	C		0		
21 7/8	22 1/2	3	FORD TRUCK	F700-900 BKT T/HDR 1 3/4" INL CTRD	T	C	4	7	BU	5 3/8	23	C		A	N	223156
									GR	3	22 1/2	C		A		
22 3/4	16 7/8	3	FORD TRUCK	8 CYL	T	C	4	9	GR	7 1/8	17	1/4		A	N	271675
									GR	3	17	C		A		
23	26 1/4	1 3/4	FORD TRUCK	BKT T/HDR RD INL 8 1/2" RT	R	C	3	11	BU	5	27 3/8	1 9/16		A	N	226139
									GR	3	26 13/16	C		A		
23 1/4	26 7/16	2 1/4	FORD TRUCK	F500-600 BKT T/HDR 1 1/2" INL 8 1/2" RT	T	C	3	10	BU	5	27 3/8	C		A	N	223160
									GR	3	26 13/16	C		A		
23 1/4	27 1/2	1 1/4	FORD TRUCK		VT	C	2	16	GR	2 7/8	27 7/8	7/8		A	N	128128
									GR	2 7/8	27 7/8	7/8		A		
23 1/4	27 1/2	2 3/16	FORD TRUCK	FEED LOT	Z	C	3	7	GR	2 7/8	27 7/8	C		A	N	286925
									GR	2 7/8	27 7/8	C		A		
23 1/4	28 1/16	2 5/8	FORD TRUCK		VT	C	4	14	GR	2 7/8	27 7/8	3/16		A	N	122660
									GR	2 7/8	27 7/8	3/16		A		
23 3/8	26 1/4	1 3/4	FORD TRUCK	F500-600 BKT T/HDR RD INL 8 1/2" RT	R	C	3	8	BU	5	27 3/8	1 9/16		A	N	226141
									GR	3	26 13/16	C		A		
23 5/8	31 3/8	2 5/8	FORD TRUCK	LIGHT TRUCK DIMPLED TUBE	VT	C	4	16	GR	3 5/8	31 1/4	C		A	N	128925
									GR	3 5/8	31 1/4	C		A		
24	25 5/8	2 3/8	FORD TRUCK	C800-1000 C7TA-8005-DS	R	C	4	9	GR	4 1/4	26 1/4	C		A	C	226804
									GR	4 1/4	26 1/4	C		A		
24	25 5/8	2 7/8	FORD TRUCK	C800-1000 C7TA-8005-DS	R	C	5	10	GR	4 1/4	26 1/4	C		A	C	226805
									GR	4 1/4	26 1/4	C		A		
24	25 7/8	3	FORD TRUCK	C800-1000 C7TA-8005-DS	T	C	4	11	GR	4 1/4	26 1/4	C		A	C	223137
									GR	4 1/4	26 1/4	C		A		
24	25 7/8	3	FORD TRUCK	F800-1000 T750-800 BKT T/HDR 1 1/4" X 3" INL CTRD	T	C	4	11	BU	6 7/8	26 7/8	C		A	C	223139
									GR	4 1/4	26 5/16	C		A		
24	26 1/4	2 3/8	FORD TRUCK	F800-1000 BKT T/HDR OVAL INL	R	C	4	8	BU	6 7/8	26 3/4	1 7/8		A	C	226465
									GR	4 1/4	26 1/4	C		A		
24	26 1/4	2 7/8	FORD TRUCK		R	C	5	8	GR	4 1/4	26 1/4	C		A	C	226467
									GR	4 1/4	26 1/4	C		A		
24	26 1/4	3 7/16	FORD TRUCK	C1000	R	C	6	9	GR	4 1/4	26 1/4	C		A	C	226474
									GR	4 1/4	26 1/4	C		A		
24	26 1/4	3 7/16	FORD TRUCK	F800-1000 BKT T/HDR OVAL INL	R	C	6	9	BU	6 7/8	26 3/4	1 7/8		A	C	226475
									GR	4 1/4	26 3/4	C		A		
24 1/4	26 1/4	1 3/4	FORD TRUCK	C500-600	R	C	3	11	GR	3	26 13/16	C		A	C	226145
									GR	3	26 13/16	C		A		
24 1/4	26 1/4	2 3/8	FORD TRUCK	C700-900	R	C	4	11	GR	3	26 13/16	3/16		A	C	226479
									GR	4 1/4	26 1/4	3/16		A		
24 1/4	26 1/4	2 3/8	FORD TRUCK	C700-900	R	C	4	11	GR	3	26 13/16	C		A	C	226480
									GR	3	26 13/16	C		A		
24 1/4	26 1/4	2 3/8	FORD TRUCK		R	C	4	11	GR	4 1/4	26 1/4	7/8		A	C	286878
									GR	3	26 13/16	1/4		A		
24 1/4	26 1/4	2 7/8	FORD TRUCK	C600-800	R	C	5	11	GR	3	26 13/16	C		A	C	226485
									GR	3	26 13/16	C		A		
24 1/4	26 7/16	2 1/4	FORD TRUCK		T	C	3	10	GR	3	26 13/16	C		A	C	223188
									GR	3	26 13/16	C		A		

Vista-Pro Automotive - Core Catalog

(Cores Sorted by Application)

Height	Width	Depth	Application	Description	Fin Type	Fin Matl	Rows	FPI	BH/TH Type	BH/TH Width	BH/TH Length	BH/TH OHF	BH/TH Bolts	BH/TH Shape	Hdr Support	Part #
FORD TRUCK (Cont)																
24 1/4	26 7/16	3	FORD TRUCK	C600-800	T	C	4	9		3	26 13/16	C		0	C	223189
										3	26 13/16	C		0		
24 5/16	26 1/4	1 3/4	FORD TRUCK	F500-750 BKT T/HDR RD INL 8 1/2" RT	R	C	3	9	BU	5	27 7/16	C		A	C	226477
									GR	3	26 13/16	C		A		
24 5/16	26 1/4	1 3/4	FORD TRUCK	L600-700 W/3208 CAT ENGINE LEVEL BKT T/HDR RD INL 8 1/2" LT	R	C	3	11	BU	5	27 7/16	1 5/16		A	C	226478
									GR	3	26 13/16	3/8		A		
24 5/16	26 1/4	2 3/8	FORD TRUCK	F700-900 W/AT BKT T/HDR RD INL 8 1/2" RT	R	C	4	9	BU	5	27 3/8	1 5/16		A	C	226481
									GR	4 1/4	26 1/4	1 5/16		A		
24 5/16	26 1/4	2 3/8	FORD TRUCK	F600-900 BKT T/HDR RD INL 8 1/2" RT	R	C	4	10	BU	5	27 3/8	C		A	C	226482
									GR	3	26 13/16	C		A		
24 5/16	26 1/4	2 3/8	FORD TRUCK	LN7000 W/3208 CAT ENGINE LEVEL BKT T/HDR RD INL 8 1/2" LT	R	C	4	10	BU	5	27 3/8	C		A	C	226484
									GR	3	26 13/16	C		A		
24 5/16	26 1/4	2 7/8	FORD TRUCK	B600-700 BKT T/HDR RD INL 8 1/2" RT	R	C	5	9	BU	5	27 3/8	1		A	C	226148
									GR	3	26 13/16	C		A		
24 5/16	26 1/4	2 7/8	FORD TRUCK	LN6000-7000 W/3208 CAT ENGINE LEVEL BKT T/HDR RD INL 8 1/2" LT	R	C	5	11	BU	5	27 3/8	C		A	C	226486
									GR	3	26 13/16	C		A		
24 5/16	26 1/4	2 7/8	FORD TRUCK	F600-800 BKT T/HDR 5" X 4" CRANK BOX	R	C	5	11	BU	5	27 3/8	C		A	C	226820
									GR	3	26 13/16	C		A		
24 5/16	26 1/4	2 15/16	FORD TRUCK	FEED LOT BKT T/HDR RD INL 8 1/2" RT	Z	C	4	7	BU	5	27 5/16	C		A	C	286466
									FR	3	26 13/16	C		A		
24 5/16	26 3/8	2	FORD TRUCK		VT	C	3	12	BU	5	27 3/8	C		A	N	122457
									GR	3	26 13/16	C		A		
24 5/16	26 7/16	2 1/4	FORD TRUCK	F600-700 BKT T/HDR RD INL 8 1/2" RT	T	C	3	10	BU	5	27 5/16	C		A	C	223167
									GR	3	26 13/16	C		A		
24 5/16	26 7/16	3	FORD TRUCK	F600-750 BKT T/HDR RD INL 8 1/2" RT	T	C	4	9	BU	5	27 5/16	C		A	C	223174
									GR	3	26 13/16	C		A		
24 5/16	26 7/16	3	FORD TRUCK	LN6000-7000 LEVEL BKT T/HDR RD INL 8 1/2" LT	T	C	4	10	BU	5	27 3/8	C		A	C	223201
									GR	3	26 13/16	C		A		
24 5/16	26 7/16	3	FORD TRUCK	F700-900 W/AT BKT T/HDR RD INL 8 1/2" RT	T	C	4	10	BU	5	27 3/8	C		A	C	223284
									GR	4 1/4	26 1/4	1/4		A		
24 5/16	26 1/2	3	FORD TRUCK	BKT T/HDR RD INL 8 1/2" RT	B	C	4	6	BU	5	27 3/8	C		A	C	229572
									GR	3	26 13/16	C		A		
25 1/4	25 7/8	2	FORD TRUCK	CARGO STAR	VT	C	3	12	GR	3 1/2	25 3/4	C		A	N	122675
									GR	3 1/2	25 3/4	C		A		
26 1/2	25 5/8	3 7/16	FORD TRUCK		S	C	6	7	GR	4 1/4	26 1/4	C		A	C	266219
									GR	4 1/4	26 1/4	C		A		
26 3/4	29 3/8	2 3/8	FORD TRUCK	C7000-8000	R	C	4	11	GR	3 1/2	29 1/8	3/16		A	C	226487
									GR	3 1/2	29 1/8	3/16		A		
27 1/2	26 1/4	2 3/8	FORD TRUCK	F600-750	R	C	4	11	GR	3	26 13/16	C		A	C	226488
									GR	3	26 13/16	C		A		
27 1/2	26 1/4	2 3/8	FORD TRUCK	LN6000-7000 W/CAT ENGINE LEVEL BKT T/HDR RD INL 8 1/2" LT	R	C	4	9	BU	5	27 3/8	1 5/16		A	C	226489
									GR	3	26 13/16	C		A		
27 1/2	26 1/4	2 7/8	FORD TRUCK	C7000-8000	R	C	5	11	GR	3	26 13/16	C		A	C	226490
									GR	3	26 13/16	C		A		
27 1/2	26 3/8	2	FORD TRUCK		VT	C	3	12	BU	5	27 3/8	C		A	N	124091
									GR	3	26 13/16	C		A		
27 1/2	26 3/8	2	FORD TRUCK		VT	C	3	12	GR	3	26 13/16	C		A	N	128591
									GR	3	26 13/16	C		A		
27 1/2	26 3/8	2 5/8	FORD TRUCK		VT	C	4	12	BU	5	27 3/8	C		A	N	124032
									GR	3	26 13/16	C		A		

Vista-Pro Automotive - Core Catalog

(Cores Sorted by Application)

Height	Width	Depth	Application	Description	Fin Type	Fin Matl	Rows	FPI	BH / TH Type	BH / TH Width	BH / TH Length	BH / TH OHF	BH / TH Bolts	BH / TH Shape	Hdr Support	Part #
FORD TRUCK (Cont)																
27 1/2	26 3/8	2 5/8	FORD TRUCK		VT	C	4	12	GR GR	3 3	26 13/16 26 13/16	C C		A A	N	128132
27 9/16	19 13/16	1 1/4	FORD TRUCK		VT	C	2	12	GR GR	2 7/8 2 7/8	20 3/4 20 3/4	3/8 3/8		A A	N	124991
27 9/16	19 13/16	2	FORD TRUCK		VT	C	3	12	GR GR	2 3/4 2 3/4	20 3/4 20 3/4	1/4 1/4		A A	N	124985
27 3/4	29 3/8	2 3/8	FORD TRUCK	C700-900	R	C	4	11	GR GR	3 1/2 3 1/2	29 1/8 29 1/8	C C		A A	C	226491
27 3/4	29 3/8	2 7/8	FORD TRUCK	C700-900	R	C	5	11	GR GR	3 1/2 3 1/2	29 1/8 29 1/8	C C		A A	C	226150
28 1/4	27 1/2	1 3/4	FORD TRUCK	F600-900, F7000-8000	R	C	3	11	GR GR	4 1/4 2 7/8	27 7/8 27 7/8	1/4 C		A A	C	226493
28 1/4	27 1/2	2	FORD TRUCK		VT	C	3	12	GR GR	4 1/4 2 7/8	27 7/8 27 7/8	1/4 C		A A	N	128686
28 1/4	27 1/2	2 3/8	FORD TRUCK	F600-900, F7000-8000	R	C	4	11	GR GR	4 1/4 2 7/8	27 7/8 27 7/8	3/16 3/16		A A	C	226492
28 1/4	27 1/2	2 3/8	FORD TRUCK	F700 6" X 6" CRANK BOX	R	C	4	11	GR GR	4 1/4 2 7/8	27 7/8 27 7/8	3/16 3/16		A A	C	226811
28 3/4	26 1/4	2 3/8	FORD TRUCK	F700 BKT T/HDR RD INL 8 1/2" RT	R	C	4	11	BU GR	5 3	27 3/8 26 13/16	1 5/16 C		A A	C	226494
28 3/4	26 7/16	2 1/4	FORD TRUCK	BKT T/HDR RD INL 8 1/2" RT	T	C	3	9	BU GR	5 3	27 5/16 26 13/16	C C		A A	C	272776
29	27 1/2	1 1/4	FORD TRUCK		VT	C	2	16	GR GR	2 7/8 2 7/8	27 7/8 27 7/8	1 7/16 1 7/16		A A	N	128137
29	27 1/2	2 3/16	FORD TRUCK	FEED LOT	Z	C	3	7	GR GR	2 7/8 2 7/8	27 7/8 27 7/8	C C		A A	C	286926
29 1/8	27 1/2	2 3/8	FORD TRUCK	F700 6" X 6" CRANK BOX	R	C	4	11	GR GR	2 7/8 2 7/8	27 7/8 27 7/8	C C		A A	C	226831
30 1/4	26 1/4	1 3/4	FORD TRUCK	L800, L8000 C/FLO	R	C	3	11	GR GR	3 3	26 13/16 26 13/16	C C		A A	C	226152
30 1/4	26 1/4	2 3/8	FORD TRUCK	L800, LN8000 C/FLO	R	C	4	11	GR GR	3 3	26 13/16 26 13/16	C C		A A	C	226153
30 1/4	26 1/4	2 15/16	FORD TRUCK	L800 FEED LOT C/FLO	Z	C	4	7	GR FR	3 3	26 13/16 26 13/16	C C		A A	C	286732
30 1/4	26 3/8	1 1/4	FORD TRUCK		VT	C	2	12	GR GR	3 3	26 13/16 26 13/16	9/16 9/16		A A	N	124885
30 1/4	26 3/8	2	FORD TRUCK		VT	C	3	12	GR GR	3 3	26 13/16 26 13/16	C C		A A	N	124886
30 1/4	26 3/8	2 5/8	FORD TRUCK		VT	C	4	12	GR GR	3 3	26 13/16 26 13/16	C C		A A	N	124887
30 1/4	26 7/16	2 1/4	FORD TRUCK	LN8000 C/FLO	T	C	3	9	GR GR	3 3	26 13/16 26 13/16	C C		A A	C	223168
30 1/4	26 1/2	2 1/4	FORD TRUCK	FEED LOT C/FLO	B	C	3	7	GR GR	3 3	26 13/16 26 13/16	C C		A A	C	272765
30 1/4	26 1/2	3	FORD TRUCK	L800, L8000 FEEDLOT C/FLO	B	C	4	7	GR GR	3 3	26 7/8 26 7/8	C C		0 0	C	229515
37 1/2	28 1/8	1 3/4	FORD TRUCK	LN7000-8000 REQUIRES BRASS TANKS REPL PTR 2 3/8" THICK SIDES	R	C	3	11	GR GR	3 3	29 1/8 29 1/8	C C		A A	C	226809
37 1/2	28 1/8	2 3/8	FORD TRUCK	LN7000-8000 LOW FLOW REPL PTR REQ BRASS TANKS DIMPLED TUBE	R	C	4	11	GR GR	3 3	29 1/4 29 1/4	C C		A A	C	226028
37 1/2	28 1/8	2 3/8	FORD TRUCK	LN7000-8000 REPL PTR REQ BRASS TANKS	R	C	4	11	GR GR	3 3	29 1/8 29 1/8	C C		A A	C	226500
37 7/8	26 15/16	2 1/4	FORD TRUCK	SEE 251034 DIMPLED TUBE	VTH	C	3	15	BL BL	10 1/4 6	31 1/4 31 1/4	1 1/2 1 1/2	56 52	XX A	N	252034

Vista-Pro Automotive - Core Catalog

(Cores Sorted by Application)

Height	Width	Depth	Application	Description	Fin Type	Fin Matl	Rows	FPI	BH/TH Type	BH/TH Width	BH/TH Length	BH/TH OHF	BH/TH Bolts	BH/TH Shape	Hdr Support	Part #
FORD TRUCK (Cont)																
37 7/8	27 3/8	1 1/2	FORD TRUCK	L9000 ULTRA-FUSED TEMPLATE #5 CAN USE 226106 OR 251101	VH	C	2	16	BL BL	10 1/4 6	31 1/4 31 1/4	1 5/8 1 5/8	56 52	XX XX	N	284722
37 7/8	27 3/8	2 1/4	FORD TRUCK	L9000 ULTRA-FUSED TEMPLATE #5 CAN USE 251107	VH	C	3	16	BL BL	10 1/4 6	31 1/4 31 1/4	1 5/8 1 5/8	56 52	XX XX	N	284070
37 7/8	27 3/8	2 1/4	FORD TRUCK	LN9000 ULTRA-FUSED LOW FLOW TEMPLATE #5A CAN USE 251034 DIMPLED TUBE	VH	C	3	14	BL BL	10 1/4 6	31 1/4 31 1/4	1 1/2 1 1/2	56 56	XX XX	N	284688
37 7/8	27 3/8	3	FORD TRUCK	L9000 ULTRA-FUSED LOW FLOW TEMPLATE #5 CAN USE 251031 DIMPLED TUBE	VH	C	4	14	BL BL	10 1/4 6	31 1/4 31 1/4	1 5/8 1 5/8	56 52	XX XX	N	284719
37 7/8	27 3/8	1 1/2	FORD TRUCK	SEE 251107	VTH	C	2	16	BL BL	10 1/4 6	31 1/4 31 1/4	1 1/2 1 1/2	56 52	XX A	N	253107
37 7/8	27 3/8	2 1/4	FORD TRUCK	SEE 251107	VTH	C	3	14	BL BL	10 1/4 6	31 1/4 31 1/4	1 1/2 1 1/2	56 52	XX A	N	252107
37 7/8	27 1/2	1 1/2	FORD TRUCK	L9000 TEMPLATE #5 CAN USE 226106	VH	C	2	14	BL BL	10 1/4 6	31 1/4 31 1/4	1 5/8 1 5/8	56 52	XX XX	N	251101
37 7/8	27 1/2	1 3/4	FORD TRUCK	L9000 TEMPLATE #5 CAN USE 282738	R	C	3	11	BL BL	10 3/8 6	31 1/4 31 1/4	1 5/8 1 5/8	56 52	XX A	C	226106
37 7/8	27 1/2	2 1/4	FORD TRUCK	L9000 LOW FLOW TEMPLATE #5A CAN USE 284688 DIMPLED TUBE	VH	C	3	15	BL BL	10 1/4 6	31 1/4 31 1/4	1 1/2 1 1/2	56 52	XX A	N	251034
37 7/8	27 1/2	2 1/4	FORD TRUCK	L9000 TEMPLATE #5 CAN USE 226108	VH	C	3	14	BL BL	10 1/4 6	31 1/4 31 1/4	1 1/2 1 1/2	56 52	XX A	N	251107
37 7/8	27 1/2	2 3/8	FORD TRUCK	L9000 LOW FLOW TEMPLATE #5A CAN USE 284688 DIMPLED TUBE	R	C	4	11	BL BL	10 1/4 6	31 1/16 31	1 1/2 1 5/8	56 52	XX XX	C	226031
37 7/8	27 1/2	2 3/8	FORD TRUCK	L9000 TEMPLATE #5	R	C	4	11	BL BL	10 3/8 6	31 1/4 31 1/4	1 5/8 1 5/8	56 52	XX A	C	226108
37 7/8	27 1/2	2 7/8	FORD TRUCK	L9000 LOW FLOW TEMPLATE #5A CAN USE 284719 DIMPLED TUBE	R	C	5	11	BL BL	10 1/4 6	31 1/16 31 1/16	1 9/16 1 9/16	56 52	XX A	C	226027
37 7/8	27 1/2	2 7/8	FORD TRUCK	L9000 TEMPLATE #5	R	C	5	11	BL BL	10 3/8 6	31 1/4 31 1/4	1 9/16 1 9/16	56 52	XX A	C	226156
37 7/8	27 1/2	3	FORD TRUCK	L9000 LOW FLOW TEMPLATE #5A CAN USE 284719 DIMPLED TUBE	VH	C	4	15	BL BL	10 1/4 6	31 1/4 31 1/4	1 9/16 1 9/16	56 56	XX XX	N	251031
37 7/8	27 1/2	3	FORD TRUCK	L9000 TEMPLATE #5 CAN USE 226156	VH	C	4	14	BL BL	10 3/8 6	31 1/4 31 1/4	1 5/8 1 5/8	56 52	XX XX	N	251105
37 7/8	27 9/16	2 1/4	FORD TRUCK	LN9000 TEMPLATE #5	T	C	3	10	BL BL	10 1/4 6	31 1/4 31 1/4	1 5/8 1 5/8	56 52	XX XX	C	223169
37 7/8	27 9/16	3	FORD TRUCK	L9000 HVY BTM HDR TEMPLATE #5	T	C	4	10	BL BH	10 1/4 6	31 1/4 31 1/4	1 5/8 C	56 52	XX XX	C	223304
38 1/2	31 1/4	2 7/8	FORD TRUCK	W9000 HVY BTM HDR TEMPLATE #4	R	C	5	11	BL BH	9 1/2 6 5/8	33 33	C C	50 47	A B	C	226161
43 1/4	33	2 1/4	FORD TRUCK	LTL9000 LOW FLOW TEMPLATE #6A CAN USE 284337 DIMPLED TUBE	VH	C	3	15	BL BL	9 5 7/16	36 3/4 36 3/4	1 1/4 1 1/4	52 48	B B	N	251011
43 1/4	33 1/16	2 1/4	FORD TRUCK	LTL9000 ULTRA-FUSED LOW FLOW TEMPLATE #6B CAN USE 251011 DIMPLED TUBE	VH	C	3	15	BL BL	9 5 7/16	36 3/4 36 3/4	1 1/4 1 1/4	52 48	B B	N	284337
43 1/4	33 1/16	2 1/4	FORD TRUCK	LTL9000 ULTRA-FUSED TEMPLATE #6A CAN USE 226110	VH	C	3	15	BL BL	9 5 7/16	36 3/4 36 3/4	1 1/4 1 1/4	52 48	B B	N	284723
43 1/4	33 1/8	2 3/8	FORD TRUCK	LTL9000 LOW FLOW TEMPLATE #6A CAN USE 284337 DIMPLED TUBE	R	C	4	11	BL BL	9 5 7/16	36 3/4 36 3/4	1 1/4 1 1/4	52 48	B B	C	226000
43 1/4	33 1/8	2 3/8	FORD TRUCK	LTL9000 TEMPLATE #6A	R	C	4	11	BL BL	9 5 7/16	36 3/4 36 3/4	1 1/4 1 1/4	52 48	B B	C	226110

Vista-Pro Automotive - Core Catalog

(Cores Sorted by Application)

Height	Width	Depth	Application	Description	Fin Type	Fin Matl	Rows	FPI	BH/TH Type	BH/TH Width	BH/TH Length	BH/TH OHF	BH/TH Bolts	BH/TH Shape	Hdr Support	Part #
FORD TRUCK (Cont)																
48 5/8	34 3/8	1 3/4	FORD TRUCK	CL9000	R	C	3	11	BL BL	5 1/2 5 1/2	37 37	C C	48 48	A A	C	226119
48 5/8	34 3/8	2 3/8	FORD TRUCK	CL9000	R	C	4	11	BL BL	5 1/2 5 1/2	37 37	1 7/16 1 7/16	48 48	A A	C	226125
FRANKLIN LOGGER																
24 3/4	24 3/4	3	FRANKLIN LOGGER		T	C	4	6	GR GR	4 3/4 4 3/4	25 1/2 25 1/2	C C		A A	C	265505
FREIGHTLINER																
29	40 5/8	2 7/8	FREIGHTLINER	LOW FLOW CAN USE 284395 DIMPLED TUBE	R	C	5	11	BL BL	7 7	43 3/8 43 3/8	C C	56 56	A A	CC	226002
34 1/2	28 1/8	2 7/8	FREIGHTLINER	BLACK CORE HVY BTM HDR	R	C	5	11	BL BH	6 3/4 6 3/4	30 1/2 30 1/2	C C	34 34	F F	C	226501
34 1/2	28 1/8	3 15/16	FREIGHTLINER	RED CORE A05-09610 HVY BTM HDR	R	C	7	11	BL BH	6 3/4 6 3/4	30 1/2 30 1/2	C C	34 34	F F	C	226503
34 1/2	28 1/8	4 1/2	FREIGHTLINER	RED CORE HVY BTM HDR	T	C	6	10	BL BH	6 3/4 6 3/4	30 1/2 30 1/2	C C	34 34	A A	C	223297
34 1/2	28 3/4	4 7/16	FREIGHTLINER	RED CORE HVY BTM HDR	R	C	8	10	BL BH	6 3/4 6 3/4	30 1/2 30 1/2	C C	34 34	F F	C	226335
37	31 3/8	2 1/4	FREIGHTLINER	GOLD A05-13034-002 ULTRA-FUSED CAN USE 226269 OR 251102	VH	C	3	13	BL BL	6 3/4 6 3/4	34 1/2 34 1/2	C C	40 40	F F	N	284647
37	32	1 1/2	FREIGHTLINER	SEE 251102	VTH	C	2	16	BL BL	6 3/4 6 3/4	34 1/2 34 1/2	C C	40 40	F F	N	253102
37	32	2 1/4	FREIGHTLINER	SEE 251102	VTH	C	3	14	BL BL	6 3/4 6 3/4	34 1/2 34 1/2	C C	40 40	F F	N	252102
37	32	2 1/4	FREIGHTLINER	SEE 251104	VTH	C	3	14	BL BL	6 3/4 6 3/4	34 1/2 34 1/2	C C	40 40	F F	N	253104
37	32	3	FREIGHTLINER	SEE 251104	VTH	C	4	14	BL BL	6 3/4 6 3/4	34 1/2 34 1/2	C C	40 40	F F	N	252104
37	32	2 1/4	FREIGHTLINER	GOLD A05-13034-002 CAN USE 226269	VH	C	3	14	BL BL	6 3/4 6 3/4	34 1/2 34 1/2	C C	40 40	F F	N	251102
37	32	3	FREIGHTLINER	BLUE A05-13034-004 CAN USE 226126	VH	C	4	14	BL BL	6 3/4 6 3/4	34 1/2 34 1/2	C C	40 40	F F	N	251104
37	32 7/16	1 1/2	FREIGHTLINER	SEE 251006 DIMPLED TUBE	VTH	C	2	16	BL BL	6 3/4 6 3/4	34 1/2 34 1/2	C C	40 40	F F	N	253006
37	32 7/16	2 1/4	FREIGHTLINER	SEE 251006 DIMPLED TUBE	VTH	C	3	15	BL BL	6 3/4 6 3/4	34 1/2 34 1/2	C C	40 40	F F	N	252006
37	32 7/16	2 1/4	FREIGHTLINER	SEE 251009 DIMPLED TUBE	VTH	C	3	15	BL BL	6 3/4 6 3/4	34 1/2 34 1/2	C C	40 40	F F	N	253009
37	32 7/16	3	FREIGHTLINER	SEE 251009 DIMPLED TUBE	VTH	C	4	15	BL BL	6 3/4 6 3/4	34 1/2 34 1/2	C C	40 40	F F	N	252009
37	32 1/2	2 1/4	FREIGHTLINER	ULTRA-FUSED LOW FLOW CAN USE 251006 DIMPLED TUBE	VH	C	3	14	BL BL	6 3/4 6 3/4	34 1/2 34 1/2	C C	40 40	F F	N	284631
37	32 1/2	3	FREIGHTLINER	NTC350,400 ULTA-FUSED LOW FLOW CAN USE 251009 DIMPLED TUBE	VH	C	4	14	BL BL	6 3/4 6 3/4	34 1/2 34 1/2	C C	40 40	ZZ A	N	284632
37	32 1/2	3	FREIGHTLINER	BLUE A05-13034-004 ULTRA-FUSED CAN USE 226126 OR 251104	VH	C	4	13	BL BL	6 3/4 6 3/4	34 1/2 34 1/2	C C	40 40	Z Z	N	284648
37	32 1/2	1 3/4	FREIGHTLINER	GREY CORE RD BOLT HOLES	R	C	3	11	BL BL	6 3/4 6 3/4	34 1/2 34 1/2	C C	40 40	F F	C	226468
37	32 1/2	1 3/4	FREIGHTLINER	GREY CORE A05-12122-000 HVY BTM HDR 8 OVAL BH	R	C	3	11	BL BH	6 3/4 6 3/4	34 1/2 34 1/2	1 3/4 1 3/4	38 38	F F	C	226504
37	32 1/2	2 1/4	FREIGHTLINER	LOW FLOW DIMPLED TUBE	VH	C	3	15	BL BL	6 3/4 6 3/4	34 1/2 34 1/2	C C	40 40	F F	N	251006

Vista-Pro Automotive - Core Catalog

(Cores Sorted by Application)

Height	Width	Depth	Application	Description	Fin Type	Fin Matl	Rows	FPI	BH/TH Type	BH/TH Width	BH/TH Length	BH/TH OHF	BH/TH Bolts	BH/TH Shape	Hdr Support	Part #
FREIGHTLINER (Cont)																
37	32 1/2	2 3/8	FREIGHTLINER	LOW FLOW CAN USE 284631 DIMPLED TUBE	R	C	4	11	BL BL	6 3/4 6 3/4	34 1/2 34 1/2	C C	40 40	F F	C	226014
37	32 1/2	2 3/8	FREIGHTLINER	GOLD CORE RD BOLT HOLES	R	C	4	11	BL BL	6 3/4 6 3/4	34 1/2 34 1/2	C C	40 40	F F	C	226269
37	32 1/2	2 3/8	FREIGHTLINER	GOLD CORE HVY BTM HDR 8 OVAL BH	R	C	4	11	BL BH	6 3/4 6 3/4	34 1/2 34 1/2	1 1/4 1 1/4	38 38	F F	C	226469
37	32 1/2	2 7/8	FREIGHTLINER	CUMMINS LOW FLOW CAN USE 284632 DIMPLED TUBE	R	C	5	11	BL BL	6 3/4 6 3/4	34 1/2 34 1/2	C C	40 40	F F	C	226033
37	32 1/2	2 7/8	FREIGHTLINER	BLUE CORE RD BOLT HOLES	R	C	5	11	BL BL	6 3/4 6 3/4	34 1/2 34 1/2	C C	40 40	F F	C	226126
37	32 1/2	3	FREIGHTLINER	CUMMINS LOW FLOW CAN USE 284632 DIMPLED TUBE	VH	C	4	15	BL BL	6 3/4 6 3/4	34 1/2 34 1/2	C C	40 40	F F	N	251009
37	32 1/2	3 7/16	FREIGHTLINER	BLUE CORE RD BOLT HOLES	R	C	6	11	BL BL	6 3/4 6 3/4	34 1/2 34 1/2	C C	40 40	F F	C	226470
37	32 1/2	3 7/16	FREIGHTLINER	BLUE CORE A05-10179-1 HVY BTM HDR 8 OVAL BH	R	C	6	11	BL BH	6 3/4 6 3/4	34 1/2 34 1/2	1 1/4 1 1/4	38 38	F F	C	226471
37	32 1/2	3 15/16	FREIGHTLINER	RD BOLT HOLES	R	C	7	10	BL BL	6 3/4 6 3/4	34 1/2 34 1/2	C C	40 40	F F	C	226505
37	32 1/2	3 15/16	FREIGHTLINER	HVY BTM HDR 8 OVAL BH	R	C	7	10	BL BH	6 3/4 6 3/4	34 1/2 34 1/2	C C	38 38	F F	C	226506
37	32 1/2	4 7/16	FREIGHTLINER	WHITE CORE A0510450-000 HVY BTM HDR 8 OVAL BH	R	C	8	10	BL BH	6 3/4 6 3/4	34 1/2 34 1/2	C C	38 38	F F	C	226473
37	32 5/8	3 3/4	FREIGHTLINER	HVY BTM HDR	T	C	5	11	BL BH	6 3/4 6 3/4	34 1/2 34 1/2	1 1/8 1 1/8	38 38	F F	C	265203
37	32 5/8	4 1/2	FREIGHTLINER	HVY BTM HDR	T	C	6	10	BL BH	6 3/4 6 3/4	34 1/2 34 1/2	C C	38 38	F F	C	265204
37 1/2	28 1/8	3 7/16	FREIGHTLINER	GREEN CORE A05-10417 HVY BTM HDR	R	C	6	11	BL BH	6 3/4 6 3/4	30 1/2 30 1/2	1 1/8 1 1/8	34 34	F F	C	226157
37 1/2	28 1/8	4 7/16	FREIGHTLINER	ORANGE CORE HVY BTM HDR	R	C	8	11	BL BH	6 3/4 6 3/4	30 1/2 30 1/2	1 1/8 1 1/8	34 34	F F	C	226507
GALION																
16 3/4	15 5/8	2 1/4	GALION	ROLLER	X	C	3	9	GR GR	6 2 1/2	15 1/2 15 1/2	1/4 C		A A	N	266325
19 1/8	18 1/8	2 1/4	GALION	D123554	X	C	3	10	GR GR	3 3/8 3 3/8	18 3/4 18 3/4	C C		A A	N	281551
19 7/8	18 1/8	2 1/4	GALION	12D 4409UD-236	X	C	3	9	GR GR	4 4	18 7/8 18 7/8	C C		A A	N	289153
19 7/8	18 9/16	2 1/4	GALION	ROLLER	T	C	3	9	GR GR	4 4	18 7/8 18 7/8	C C		A A	N	279212
20 1/4	18 9/16	2 1/4	GALION	ROLLER	T	C	3	10	GR GR	4 1/4 4 1/4	20 20	1/4 1/4		A A	N	262996
20 1/4	18 3/4	2 3/16	GALION		Z	C	3	10	GR GR	4 1/4 4 1/4	20 20	3/16 3/16		A A	N	287736
22 1/2	23 1/16	3	GALION		T	C	4	9		4 1/4 4 1/4	23 3/4 23 3/4	C C		0 0	N	279213
22 1/2	23 1/8	2 3/8	GALION	CRANE D-77013	S	C	4	10	GR GR	3 1/2 3 1/2	23 3/4 23 3/4	C C		A A	N	229063
22 1/2	23 1/8	2 7/8	GALION	ROLLER D-119223, D-124204	S	C	5	9	GR GR	3 1/2 3 1/2	23 3/4 23 3/4	C C		A A	N	229127
22 1/2	23 1/8	3	GALION		X	C	4	9	GR GR	4 1/4 4 1/4	23 3/4 23 3/4	C C		A A	N	286559
22 1/2	23 1/8	3	GALION	104363	X	C	4	9	GR GR	3 1/2 3 1/2	23 3/4 23 3/4	C C		A A	N	286872

Vista-Pro Automotive - Core Catalog

(Cores Sorted by Application)

Height	Width	Depth	Application	Description	Fin Type	Fin Matl	Rows	FPI	BH/TH Type	BH/TH Width	BH/TH Length	BH/TH OHF	BH/TH Bolts	BH/TH Shape	Hdr Support	Part #
GALION (Cont)																
22 1/2	23 5/8	3	GALION	WAUKESHA 150	T	C	4	9	GR GR	3 1/2 3 1/2	23 3/4 23 3/4	C C		A A	N	265509
23	23 1/16	2 1/4	GALION	WAUKESHA ENGINE	T	C	3	7	GR GR	4 3/8 4 3/8	24 24	C C		A A	N	279215
23	23 1/16	3 3/4	GALION		T	C	5	9	GR GR	4 3/8 4 3/8	24 24	C C		A A	N	279216
23	23 1/8	2 3/8	GALION		S	C	4	9	GR GR	4 3/8 4 3/8	24 24	C C		A A	N	266324
23	23 1/8	3	GALION		X	C	4	9	GR GR	4 3/8 4 3/8	24 24	C C		A A	N	286560
24 7/16	28 1/8	3	GALION	101-104,116, 118 GRADER HVY BTM HDR	T	C	4	9	BL BH	5 1/2 5 1/2	32 32	C C	28 28	F F	C	279217
25 3/4	25	3	GALION		X	C	4	11	GR GR	3 1/2 3 1/2	25 3/4 25 3/4	C C		A A	C	221858
25 3/4	25 5/16	3	GALION		T	C	4	11	GR GR	3 1/2 3 1/2	25 3/4 25 3/4	C C		A A	C	279218
28	24 3/16	2 1/4	GALION	ROLLER	T	C	3	7	GR GR	8 3	25 3/4 25 3/4	1/4 1/4		A A	C	223143
28 9/16	28 11/16	3 3/4	GALION	GRADER HVY BTM HDR	T	C	5	8	BL BH	7 5/16 7 5/16	32 1/4 32 1/4	C C	40 40	A A	C	274736
28 9/16	28 11/16	4 1/2	GALION	ROLLER	T	C	6	9	BL BL	7 5/16 7 5/16	32 1/4 32 1/4	C C	40 40	A A	C	261516
28 9/16	28 3/4	4 7/16	GALION	BRASS FINES	Z	B	6	7	BL BL	7 5/16 7 5/16	32 1/2 32 1/2	1 1/2 1 1/2	40 40	B B	C	225310
29 3/8	27 1/2	3 7/16	GALION	GRADER D-138833	S	C	6	10	GR GR	4 1/4 4 1/4	28 1/4 28 1/4	C C		A A	C	229066
32 1/2	27 1/2	2 7/8	GALION	T500 G-79356	S	C	5	9	GR GR	4 1/4 4 1/4	28 1/4 28 1/4	C C		A A	C	229067
32 1/2	27 1/2	2 15/16	GALION		Z	C	4	10	GR GR	4 1/4 4 1/4	28 1/4 28 1/4	C C		A A	C	286563
32 1/2	27 1/2	3 7/16	GALION	T500 D-73488-A	S	C	6	10	GR GR	4 1/4 4 1/4	28 1/4 28 1/4	C C		A A	C	229068
32 1/2	27 1/2	3 3/4	GALION	GRADER	X	C	5	9	GR GR	4 1/4 4 1/4	28 1/4 28 1/4	C C		A A	C	289602
GARDNER DENVER																
22 1/2	22 1/2	2 1/4	GARDNER DENVER		T	C	3	9	BL BL	4 3/8 4 3/8	26 1/2 26 1/2	C C	28 28	A A	C	272661
22 7/8	27 1/2	2 7/8	GARDNER DENVER	185 CFM COMPRESSOR 2014438	S	C	5	9	GR GR	4 1/4 4 1/4	28 1/4 28 1/4	C C		A A	N	229069
23 1/8	23 1/8	2 3/8	GARDNER DENVER	150 CFM COMPRESSOR 200SPH300	S	C	4	11	GR GR	3 3	23 15/16 23 15/16	C C		A A	N	229070
24 3/8	22 1/2	2 1/4	GARDNER DENVER	SP 125G	T	C	3	8	BL BL	4 3/8 4 3/8	26 3/8 26 3/8	C C	28 28	A A	C	223146
25 7/8	13 3/4	2 3/8	GARDNER DENVER	100-150 COMPRESSOR	S	C	4	11	GR GR	3 1/4 3 1/4	14 1/4 14 1/4	C C		A A	C	229072
27 5/16	10 5/8	2 1/4	GARDNER DENVER	HVY T/BTM HDRS	X	C	3	9	BH BH	7 7	12 3/4 12 3/4	2 7/8 2 7/8	18 18	A A	C	288469
27 5/16	10 5/8	3	GARDNER DENVER	HVY T/BTM HDRS	X	C	4	6	BH BH	7 7	12 3/4 12 3/4	1 1/2 1 1/2	18 18	A A	C	260208
41 1/8	21 1/4	2 7/8	GARDNER DENVER	450 CFM COMPRESSOR 1157590T1	S	C	5	9	GR GR	3 7/16 3 7/16	21 15/16 21 15/16	C C		A A	C	229076
45	30	6	GARDNER DENVER	1200 CFM HVY BTM HDR BRASS FINES	Z	B	8	9	BL BH	9 5/8 9 5/8	32 1/4 32 1/4	C C	46 46	A A	C	282682

Vista-Pro Automotive - Core Catalog

(Cores Sorted by Application)

Height	Width	Depth	Application	Description	Fin Type	Fin Matl	Rows	FPI	BH / TH Type	BH / TH Width	BH / TH Length	BH / TH OHF	BH / TH Bolts	BH / TH Shape	Hdr Support	Part #
GARDNER DENVER (Cont)																
50	62 7/16	2 1/4	GARDNER DENVER	DETROIT DIESEL ENGINE HVY T/BTM HDRS	T	C	3	9	BH BH	7 7	67 67	C C	76 76	A A	CC	223311
GENERAL ELECTRIC																
40 3/4	36 1/4	4 7/16	GENERAL ELECTRIC	80 TON LOCOMOTIVE BRASS FINS	Z	B	6	7	BL BL	6 7/8 6 7/8	38 3/4 38 3/4	C C	34 34	A A	C	287991
40 3/4	36 9/16	3 3/4	GENERAL ELECTRIC	80 TON LOCOMOTIVE HVY BTM HDR	T	C	5	8	BL BH	6 7/8 6 7/8	38 3/4 38 3/4	C C	34 34	A A	C	276785
GILLIG BUS																
28 15/16	35	2 7/8	GILLIG BUS		R	C	5	11	BL BL	6 5/8 6 5/8	37 7/8 37 7/8	C C	46 46	A A	C	226325
31 5/8	21 7/8	3 15/16	GILLIG BUS	OE 82-17447-009	S	C	7	10	BL BL	7 5/8 7 5/8	24 24	C C	34 34	A A	C	223630
31 3/4	38 3/4	3 15/16	GILLIG BUS	DIMPLED TUBE	R	C	7	9	BL BL	6 9/16 6 9/16	41 3/4 41 3/4	C C	50 50	A A	C	226869
GENERAL MOTORS / CHEVY TRUCKS																
12	11 9/16	2	GM		VT	C	3	12	GR GR	2 3/4 2 1/4	13 3/16 13 1/4	C C		A A	N	124608
12	14 7/8	2	GM		VT	C	3	12	GR GR	2 3/4 2 3/4	16 1/2 16 1/2	C C		A A	N	124786
12 1/4	23 1/8	1 1/4	GM		VT	C	2	12	GR GR	2 1/2 2	23 1/2 23 1/2	3/8 C		A A	N	122299
12 1/4	25 5/16	2	GM		VT	C	3	12	GR GR	2 3/4 2 3/4	25 7/16 25 7/16	C C		A A	N	122362
12 5/8	18 11/16	2	GM		VT	C	3	12	GR GR	2 1/4 2 1/4	18 1/2 18 1/2	C C		A A	N	122417
13 1/2	17 1/16	2	GM		VT	C	3	12	GR GR	2 5/8 2 1/8	16 7/8 16 3/4	C C		A A	N	128475
13 5/8	20 7/8	1 1/4	GM		VT	C	2	16	GR GR	1 7/8 1 7/8	21 21	C C		A A	N	128278
14 5/16	25 5/16	1 1/4	GM		VT	C	2	12	GR GR	2 3/4 2 3/4	25 7/16 25 7/16	3/8 3/8		A A	N	122444
14 5/16	25 5/16	2	GM		VT	C	3	12	GR GR	2 3/4 2 3/4	25 7/16 25 7/16	C C		A A	N	122446
14 5/16	25 5/16	2 5/8	GM		VT	C	4	12	GR GR	3 3/8 3 3/8	25 7/16 25 7/16	C C		A A	N	122448
15 1/2	18 11/16	2	GM		VT	C	3	12	GR GR	2 1/4 2 1/4	18 1/2 18 1/2	C C		0 A	N	122490
15 1/2	23 1/8	1 1/4	GM		VT	C	2	12	GR GR	2 2	23 1/2 23 1/2	C C		A A	N	122345
15 1/2	23 1/8	1 1/4	GM		VT	C	2	12	GR GR	2 1/2 2	23 1/2 23 1/2	1/4 C		A A	N	122358
15 1/2	23 1/8	2	GM		VT	C	3	12	FR FR	2 1/16 2 1/16	23 1/2 23 1/2	C C		0 0	N	122606
15 1/2	23 1/8	2	GM		VT	C	3	12	GR GR	2 1/2 2 1/4	23 1/2 23 1/2	C C		A A	N	122303
15 1/2	23 5/8	2	GM		VT	C	3	12	GR GR	2 1/2 2 1/8	23 1/2 23 1/2	C C		A A	N	128609
15 1/2	23 5/8	2 5/8	GM		VT	C	4	12	GR GR	2 3/4 2 3/4	23 1/2 23 1/2	C C		A A	N	128404
15 1/2	25 5/16	2 5/8	GM		VT	C	4	12	GR GR	2 3/4 2 3/4	25 7/16 25 7/16	C C		A A	N	128354
15 1/2	25 5/16	2 5/8	GM		VT	C	4	12	GR GR	3 2 3/4	25 7/16 25 7/16	C C		A A	N	128353

Vista-Pro Automotive - Core Catalog

(Cores Sorted by Application)

Height	Width	Depth	Application	Description	Fin Type	Fin Matl	Rows	FPI	BH/TH Type	BH/TH Width	BH/TH Length	BH/TH OHF	BH/TH Bolts	BH/TH Shape	Hdr Support	Part #
GENERAL MOTORS / CHEVY TRUCKS (Cont)																
16	16 1/2	1 1/4	GM		VT	C	2	12	GR	2 3/4	17	C		A	N	128110
									GR	2	17	C		A		
16	25 5/16	1 1/4	GM		VT	C	2	12	GR	2 1/2	25 7/16	C		A	N	128643
									GR	2 1/2	25 7/16	C		A		
16	25 5/16	2	GM		VT	C	3	12	GR	2 1/2	25 7/16	C		A	N	122517
									GR	2 1/2	25 7/16	C		A		
16 1/8	14 1/16	1	GM	VE-8547 CORE	VE	C	2	14	GR	1 13/16	14 9/16	C		A	N	128547
									GR	1 13/16	14 9/16	C		A		
16 3/4	11 9/16	1 1/4	GM		VT	C	2	12	GR	2 3/4	13 3/16	C		A	N	124790
									GR	2	13 3/16	C		A		
16 3/4	21 7/16	1 1/4	GM		VT	C	2	14	BX	2	21 1/2	C		A	N	128307
									BX	2	21 1/2	C		A		
16 3/4	23 1/8	1 1/4	GM		VT	C	2	14	BX	2	23	C		A	N	128308
									BX	2	23	C		A		
16 7/8	14 7/8	1 1/4	GM		VT	C	2	14	GR	2 3/8	16 1/2	3/8		A	N	124987
									GR	2 3/8	16 1/2	3/8		A		
16 7/8	14 7/8	2	GM		VT	C	3	14	GR	2 3/8	16 1/2	C		A	N	128194
									GR	2 3/8	16 1/2	C		A		
16 7/8	15 1/4	1 9/16	GM	J CAR	VE	C	3	14	GR	2 3/8	16 1/2	C		A	N	128133
									GR	2 3/8	16 1/2	C		A		
16 7/8	16 15/16	1 9/16	GM		VE	C	3	14	GR	2 3/8	18 5/8	C		A	N	122326
									GR	2 3/8	18 5/8	C		A		
16 7/8	17 1/16	2	GM		VT	C	3	12	GR	2 3/8	18 5/8	C		A	N	128197
									GR	2 3/8	18 5/8	C		A		
17	23 1/8	2	GM		VT	C	3	12	GR	2 1/2	23 1/2	C		A	N	122486
									GR	2 1/4	23 1/2	C		A		
17	25 5/16	2 5/8	GM		VT	C	4	12	GR	2 3/4	25 7/16	C		A	N	128403
									GR	2 3/4	25 7/16	C		A		
17 3/8	23 1/8	2	GM		VT	C	3	12	GR	2 1/2	23 1/2	C		A	N	122594
									GR	2 1/4	23 1/2	C		A		
17 3/8	25 5/16	2	GM	Reg. plant model	VT	C	3	12	GR	3	25 7/16	3/8		A	N	122356
									GR	2 3/4	25 7/16	C		A		
17 3/8	25 5/16	2	GM		VT	C	3	12	GR	2 3/4	25 7/16	C		A	N	122405
									GR	2 3/4	25 7/16	C		A		
17 3/8	25 5/16	2	GM		VT	C	3	12	GR	3	25 7/16	3/8		A	N	128207
									GR	2 1/2	25 7/16	C		A		
17 3/8	25 5/16	2 5/8	GM		VT	C	4	12	GR	3	25 7/16	C		A	N	122378
									GR	2 7/8	25 7/16	C		A		
17 3/8	25 5/16	2 5/8	GM		VT	C	4	12	GR	2 3/4	25 7/16	C		A	N	128333
									GR	2 3/4	25 7/16	C		A		
17 5/8	25 5/16	2	GM		VT	C	3	12	GR	2 3/4	25 7/16	C		A	N	122286
									GR	2 3/4	25 7/16	C		A		
17 3/4	22	2	GM		VT	C	3	12	BU	3 1/2	22 1/8	C		A	N	122229
									GR	2 1/2	22 1/8	C		A		
17 3/4	23 1/8	1 1/4	GM		VT	C	2	14	BX	2	23	C		A	N	128305
									BX	2	23	C		A		
17 3/4	25 5/16	1 1/4	GM		VT	C	2	12	GR	3	25 7/16	C		A	N	122247
									GR	2 3/4	25 7/16	C		A		
17 3/4	25 5/16	2	GM		VT	C	3	12	GR	3	25 7/16	C		A	N	122336
									GR	2 3/4	25 7/16	C		A		
18	19 1/4	2	GM		VT	C	3	12	BU	3 11/16	19 1/2	C		A	N	122255
									GR	2 1/2	19 3/8	C		A		
18 1/4	19 13/16	2	GM		VT	C	3	12	BU	3 3/4	19 7/8	C		A	N	122200
									GR	2 1/4	19 3/4	C		A		

Vista-Pro Automotive - Core Catalog

(Cores Sorted by Application)

Height	Width	Depth	Application	Description	Fin Type	Fin Matl	Rows	FPI	BH/TH Type	BH/TH Width	BH/TH Length	BH/TH OHF	BH/TH Bolts	BH/TH Shape	Hdr Support	Part #
GENERAL MOTORS / CHEVY TRUCKS (Cont)																
18 5/16	23 5/8	2	GM		VT	C	3	12	BU GR	3 11/16 2 1/2	23 3/4 23 3/4	C C		A A	N	122292
18 7/16	22	2	GM		VT	C	3	12	BU GR	3 3/4 2 3/4	22 1/8 22 1/8	C C		A A	N	122232
18 1/2	17 1/16	2 5/8	GM		VT	C	4	12	GR GR	3 3	18 1/2 18 1/2	C C		A A	N	128357
18 1/2	17 1/16	2 5/8	GM		VT	C	4	12	GR GR	3 3	18 1/2 18 1/2	C C		A A	N	128365
18 5/8	25 5/16	2	GM		VT	C	3	12	GR GR	3 2 3/4	25 7/16 25 7/16	C C		A A	N	122290
18 5/8	25 5/16	2 5/8	GM		VT	C	4	12	GR GR	3 3/8 3 3/8	25 7/16 25 7/16	C C		A A	N	122388
18 11/16	19 13/16	2	GM		VT	C	3	12	BX BX	2 2	19 11/16 19 11/16	C C		A A	N	128480
18 7/8	19 13/16	1 1/4	GM		VT	C	2	14	BX BX	2 2	19 3/4 19 3/4	C C		A A	N	128303
18 7/8	21 7/16	1 1/4	GM		VT	C	2	14	BX BX	2 2	21 1/4 21 1/4	C C		A A	N	128464
18 7/8	21 7/16	2	GM		VT	C	3	12	BX BX	2 2	21 3/8 21 3/8	C C		A A	N	128479
19	19 11/16	2 1/4	CHEV/GMC	1 1/2 - 2 TON CELLULAR REPLACEMENT	T	C	3	8	BX BX	2 1/2 2 1/2	19 3/4 19 3/4	C C		A A	N	260644
19 5/8	14 7/8	2	GM		VT	C	3	14	GR GR	2 3/8 2 3/8	16 1/2 16 1/2	3/8 3/8		A A	N	128195
19 5/8	15 1/4	1	GMC TRUCK		VE	C	2	14	GR GR	2 3/8 2 3/8	16 1/2 16 1/2	1 1		A A	N	128157
19 5/8	15 1/4	1 9/16	GM		VE	C	3	14	GR GR	2 3/8 2 3/8	16 1/2 16 1/2	C C		A A	N	128158
19 3/4	22	2	GM		VT	C	3	12	BU GR	3 1/2 2 1/2	22 1/8 22 1/8	C C		A A	N	122263
19 13/16	19 1/4	2	GM		VT	C	3	12	BU GR	3 11/16 2 1/2	19 1/2 19 3/8	C C		A A	N	122257
19 7/8	21 1/4	1 3/4	CHEV/GMC	CELLULAR REPLACEMENT	R	C	3	9	BX BX	2 2	21 3/8 21 3/8	C C		A A	N	226321
19 7/8	21 7/16	2	GM		VT	C	3	12	BX BX	2 2	21 3/8 21 3/8	C C		A A	N	121021
19 7/8	23 1/8	1 3/4	CHEV/GMC	P 50-60 CELLULAR REPLACEMENT	R	C	3	8	BX BX	2 2	23 3/8 23 3/8	C C		A A	N	226336
19 7/8	23 1/8	2 3/8	CHEV/GMC	P 50-60 CELLULAR REPLACEMENT	R	C	4	9	BX BX	2 1/2 2 1/2	23 3/8 23 3/8	C C		A A	N	226337
19 7/8	23 5/8	2 1/4	CHEV/GMC	CELLULAR REPLACEMENT	T	C	3	8	BX BX	2 1/2 2 1/2	23 3/8 23 3/8	C C		A A	N	261022
19 7/8	23 5/8	2	GM		VT	C	3	12	BX BX	2 2	23 5/8 23 5/8	C C		A A	N	121026
19 7/8	23 5/8	2 5/8	GM		VT	C	4	12	BX BX	3 3	23 3/8 23 3/8	C C		A A	N	121027
20	21 7/16	2	GM		VT	C	3	12	BX BX	2 1/4 2 1/4	21 3/8 21 3/8	C C		A A	N	128482
20	23 1/8	2	GM		VT	C	3	12	BX BX	2 1/2 2 1/2	23 1/2 23 1/2	C C		A A	N	128316
20	23 5/8	2 5/8	GM		VT	C	4	12	BX BX	2 5/8 2 5/8	23 5/8 23 5/8	C C		A A	N	128478
20 1/16	25 5/16	2	GM		VT	C	3	12	GR GR	3 2 3/4	25 7/16 25 7/16	C C		A A	N	122271

Vista-Pro Automotive - Core Catalog

(Cores Sorted by Application)

Height	Width	Depth	Application	Description	Fin Type	Fin Matl	Rows	FPI	BH/TH Type	BH/TH Width	BH/TH Length	BH/TH OHF	BH/TH Bolts	BH/TH Shape	Hdr Support	Part #
GENERAL MOTORS / CHEVY TRUCKS (Cont)																
20 3/8	14 7/8	2 5/8	GM		VT	C	4	16	GR	2 7/8	16 1/2	C		A	N	128460
									GR	2 7/8	16 1/2	C		A		
20 3/8	23 1/8	2	GM		VT	C	3	12	BU	3 11/16	23 3/4	C		A	N	122238
									GR	2 1/2	23 3/4	C		A		
20 3/8	23 5/8	2	GM		VT	C	3	12	BU	3 11/16	23 3/4	C		A	N	122227
									GR	2 1/2	23 3/4	C		A		
20 3/8	25 5/16	2	GM		VT	C	3	12	BU	3 3/4	25 1/2	C		A	N	122272
									GR	2 1/2	25 7/16	C		A		
20 1/2	23 1/8	1 1/4	GM		VT	C	2	14	BX	2	23 1/2	C		A	N	128311
									BX	2	23 1/2	C		A		
20 5/8	19 3/8	2 3/8	CHEV/GMC	P 50-60 CELLULAR REPLACEMENT	R	C	4	7	BX	3	19 3/4	C		A	N	226338
									BX	3	19 3/4	C		A		
20 5/8	19 11/16	3	CHEV/GMC	1 1/2 - 2 TON CELLULAR REPLACEMENT	T	C	4	9	BX	3	19 5/8	C		A	N	223075
									BX	3	19 5/8	C		A		
20 5/8	20	1 3/4	CHEV/GMC	P 50-60 CELLULAR REPLACEMENT	R	C	3	7	BX	2	19 3/4	C		A	N	226339
									BX	2	19 3/4	C		A		
20 11/16	19 13/16	2	GM		VT	C	3	12	BX	2	19 11/16	C		A	N	122028
									BX	2	19 11/16	C		A		
20 11/16	19 13/16	2	GM		VT	C	3	12	BX	2	19 11/16	C		A	N	128667
									BX	2	19 11/16	C		A		
20 11/16	19 13/16	2 5/8	GM		VT	C	4	12	BX	2 5/8	19 11/16	C		A	N	128477
									BX	2 5/8	19 11/16	C		A		
20 11/16	19 13/16	1 1/4	GM		VT	C	2	14	GR	2	19 11/16	C		A	N	128302
									GR	2	19 11/16	C		A		
20 11/16	19 13/16	2 5/8	GM		VT	C	4	12	BX	3	19 11/16	C		A	N	122029
									BX	3	19 11/16	C		A		
20 3/4	11 9/16	2	GM		VT	C	3	12	GR	2 3/4	13 1/4	C		A	N	122313
									FR	2	13 1/4	C		A		
20 3/4	11 9/16	2 5/8	GM		VT	C	4	12	GR	2 3/4	13 3/16	C		A	N	122613
									GR	2 3/4	13 3/16	C		A		
20 3/4	15 3/8	2 5/8	GM		VT	C	4	12	GR	3 5/16	16 11/16	1/4		A	N	122438
									GR	3 5/16	16 11/16	1/4		A		
20 3/4	16 15/16	1 9/16	GM		VE	C	3	14	GR	2 3/4	18 5/8	C		A	N	128731
									GR	2 3/4	18 5/8	C		A		
20 3/4	17 1/16	2	GM		VT	C	3	12	GR	2 1/16	18 5/8	C		A	N	128619
									GR	2 3/4	18 5/8	C		A		
20 3/4	17 1/16	2	GM		VT	C	3	12	GR	3 1/2	18 5/8	C		A	N	122479
									GR	3 1/2	18 5/8	C		A		
20 3/4	17 1/16	2 5/8	GM		VT	C	4	12	GR	2 3/4	18 5/8	C		A	N	122604
									GR	2 3/4	18 5/8	C		A		
20 3/4	17 3/8	1 9/16	GM		VE	C	3	16	GR	2 1/16	18 5/8	3/8		A	N	128707
									GR	2 3/4	18 5/8	3/8		A		
20 3/4	19 3/8	3 3/4	GM		X	C	5	9	CR	4 9/16	19 1/16	3/8		A	N	265920
									CR	3 13/16	19 1/16	C		A		
20 3/4	22	2	GM		VT	C	3	12	BU	3 13/16	22	C		A	N	122230
									GR	2 9/16	22	C		A		
21 1/8	23 1/8	1 1/4	GM		VT	C	2	14	BX	2	23 1/2	C		A	N	128310
									BX	2	23 1/2	C		A		
22	17 1/16	2	GM		VT	C	3	12	GR	3 1/2	18 5/8	3/8		A	N	122576
									GR	3 1/2	18 5/8	3/8		A		
22	17 1/16	2 5/8	CHEV/GMC	CHEV TRK	VT	C	4	12	GR	3 1/2	18 5/8	C		A	N	122584
									GR	3 1/2	18 5/8	C		A		
22	28 1/16	2	GM		VT	C	3	14	GR	3 1/2	28 3/4	3/8		A	N	128655
									GR	3 1/2	28 3/4	3/8		A		

Vista-Pro Automotive - Core Catalog

(Cores Sorted by Application)

Height	Width	Depth	Application	Description	Fin Type	Fin Matl	Rows	FPI	BH/TH Type	BH/TH Width	BH/TH Length	BH/TH OHF	BH/TH Bolts	BH/TH Shape	Hdr Support	Part #
22	28 11/16	3	CHEV/GMC		T	C	4	9	GR GR	3 1/2 3 1/2	28 3/4 28 3/4	C C		A A	N	223076
22 1/8	21 7/16	2	GM		VT	C	3	12	BU GR	3 13/16 2 9/16	22 22	C C		A A	N	122213
22 1/8	22	1 1/4	GM		VT	C	2	14	BX BX	2 2	21 7/8 21 7/8	C C		A A	N	128306
22 1/8	22	2	GM		VT	C	3	12	BX BX	2 1/2 2 1/2	21 7/8 21 7/8	C C		A A	N	128304
22 1/2	17 1/16	2 5/8	GM		VT	C	4	16	GR GR	3 1/2 3 1/2	18 5/8 18 5/8	C C		A A	N	128776
22 1/2	18 1/8	2 5/8	GM		VT	C	4	12	BX BX	3 3	18 18	C C		A A	N	121442
22 1/2	23 5/8	2 1/4	CHEV/GMC	CELLULAR REPLACEMENT	T	C	3	8	BX BX	2 1/2 2 1/2	23 5/8 23 5/8	C C		A A	N	261137
23	17 1/16	2	GM		VT	C	3	12	GR GR	3 1/2 3 1/2	18 5/8 18 5/8	C C		A A	N	122555
23	17 1/16	2 5/8	GM		VT	C	4	12	GR GR	2 3/4 2 3/4	18 5/8 18 5/8	C C		A A	N	122607
23 5/8	14 7/8	2	GM		VT	C	3	14	GR GR	2 3/8 2 3/8	16 1/2 16 1/2	C C		A A	N	128196
23 5/8	15 1/4	1 9/16	GM	VE CORE;3R-14 FPI	VE	C	3	14	GR GR	2 3/8 2 3/8	16 1/2 16 1/2	C C		A A	N	128107
24	28 11/16	2 1/4	CHEV/GMC	T 70-80 COE	T	C	3	9	GR GR	3 1/2 3 1/2	28 3/4 28 3/4	C C		A A	C	223078
24	28 3/4	2 3/8	CHEV/GMC	T 70-80	R	C	4	7	GR GR	3 1/2 3 1/2	28 3/4 28 3/4	13/16 13/16		A A	C	226342
24 5/8	23 5/8	2	GM		VT	C	3	12	BU GR	4 3/8 3 3/8	23 3/4 23 3/4	C C		A A	N	122236
24 5/8	23 5/8	2 5/8	GM		VT	C	4	12	BU BU	4 3/8 3 3/8	23 3/4 23 3/4	C C		A A	N	122414
24 3/4	23 1/8	1 1/4	CHEV/GMC	CHEV TRK	VT	C	2	12	GR GR	2 3/4 2 3/4	25 7/16 25 7/16	3/8 3/8		A A	N	122513
24 3/4	23 1/8	2	GM		VT	C	3	12	GR GR	3 3	25 7/16 25 7/16	C C		A A	N	128468
24 3/4	23 1/8	2 5/8	GM		VT	C	4	12	GR GR	3 2 3/4	25 7/16 25 7/16	C C		A A	N	128485
24 3/4	23 3/4	1 3/4	CHEV/GMC	C 50-60 CELLULAR REPLACEMENT	R	C	3	8	BX BX	2 2	23 5/8 23 5/8	C C		A A	C	226343
25 1/2	28 3/4	2 3/8	CHEV/GMC	T 6000	R	C	4	11	GR GR	3 1/2 3 1/2	28 7/8 28 7/8	C C		A A	C	226111
26 3/8	16 15/16	1	GM	VE CORE;2R-17 FPI	VE	C	2	17	GR GR	2 3/8 2 3/8	18 5/8 18 5/8	C C		A A	N	128182
26 3/8	16 15/16	1 9/16	GM		VE	C	3	14	GR GR	2 3/4 2 3/4	18 5/8 18 5/8	7/16 7/16		A A	N	128211
26 3/8	16 15/16	1 9/16	GM	VE CORE;3R-17 FPI	VE	C	3	17	GR GR	2 3/8 2 3/8	18 5/8 18 5/8	C C		A A	N	128183
26 3/8	16 15/16	1 9/16	GM		VE	C	3	14	GR GR	2 3/4 2 1/16	18 5/8 18 5/8	3/8 C		A A	N	122332
26 3/8	17 1/16	1 1/4	GM		VT	C	2	16	GR GR	2 3/4 2 3/4	18 5/8 18 5/8	C C		A A	N	128779
26 3/8	17 1/16	1 1/4	GM		VT	C	2	12	GR GR	3 1/2 2 3/4	18 5/8 18 5/8	C C		A A	N	122441
26 3/8	17 1/16	1 1/4	GM		VT	C	2	12	GR GR	3 1/2 2 3/4	18 5/8 18 5/8	C 3/8		A A	N	124501

Vista-Pro Automotive - Core Catalog

(Cores Sorted by Application)

Height	Width	Depth	Application	Description	Fin Type	Fin Matl	Rows	FPI	BH/TH Type	BH/TH Width	BH/TH Length	BH/TH OHF	BH/TH Bolts	BH/TH Shape	Hdr Support	Part #
GENERAL MOTORS / CHEVY TRUCKS (Cont)																
26 3/8	17 1/16	1 1/4	GM		VT	C	2	14	GR	2 3/8	18 5/8	7/16		A	N	128149
									GR	2 3/8	18 5/8	7/16		A		
26 3/8	17 1/16	2	GM	Reg. plant model	VT	C	3	12	GR	2 3/4	18 5/8	C		A	N	122521
									GR	2 3/4	18 5/8	C		A		
26 3/8	17 1/16	2	GM		VT	C	3	12	GR	2 1/16	18 5/8	C		A	N	122633
									GR	2 3/4	18 5/8	C		A		
26 3/8	17 1/16	2	GM		VT	C	3	14	GR	2 3/8	18 5/8	C		A	N	128198
									GR	2 3/8	18 5/8	C		A		
26 3/8	17 1/16	2 5/8	GM		VT	C	4	16	GR	2 3/4	18 5/8	C		A	N	128355
									GR	2 3/4	18 5/8	C		A		
26 3/8	17 1/16	2 5/8	GM		VT	C	4	14	GR	3 3/4	18 5/8	C		A	N	128459
									GR	3 3/4	18 5/8	C		A		
26 3/8	17 1/16	2 5/8	GM		VT	C	4	12	GR	2 3/4	18 5/8	C		A	N	128732
									GR	2 3/4	18 5/8	C		A		
26 3/8	19 1/4	2 5/8	GM		VT	C	4	12	GR	3 1/2	20 7/8	C		A	N	124879
									GR	3 1/2	20 7/8	C		A		
26 3/8	24 3/16	1 1/4	CHEV/GMC	CHEV TRK	VT	C	2	12	GR	2 3/4	25 3/4	3/8		A	N	122527
									GR	2 3/4	25 3/4	3/8		A		
26 3/8	24 3/16	2	CHEV/GMC	CHEV TRK	VT	C	3	12	GR	2 3/4	25 3/4	C		A	N	122550
									GR	2 3/4	25 3/4	C		A		
27 1/2	16 15/16	1 9/16	GM		VE	C	3	16	GR	2 3/4	18 5/8	C		A	N	128782
									GR	2 3/4	18 5/8	C		A		
27 1/2	17 1/16	2	GM		VT	C	3	12	GR	3 1/2	18 5/8	C		A	N	128385
									GR	3 1/2	18 5/8	C		A		
27 1/2	17 1/16	2	GM		VT	C	3	16	GR	2 3/4	18 5/8	C		A	N	128680
									GR	2 3/4	18 5/8	C		A		
27 1/2	17 1/16	2 5/8	GM	Reg. plant model	VT	C	4	12	GR	3 1/2	18 5/8	C		A	N	124504
									GR	3 1/2	18 5/8	C		A		
27 1/2	17 1/16	2 5/8	GM		VT	C	4	12	GR	2 3/4	18 5/8	C		A	N	122625
									GR	2 3/4	18 5/8	C		A		
28 1/8	28 3/4	3 7/16	CHEV/GMC	BUS 797246	R	C	6	8	BL	6 1/4	30 7/8	C	38	F	C	226260
									BL	6 1/4	30 7/8	C	38	F		
28 1/4	16 15/16	1	CHEV/GMC	CHEV TRK	VE	C	2	17	GR	2 3/8	18 5/8	1		A	N	128184
									GR	2 3/8	18 5/8	1		A		
28 1/4	16 15/16	1 9/16	GM		VE	C	3	14	GR	2 3/4	18 5/8	C		A	N	122337
									GR	2 1/16	18 5/8	C		A		
28 1/4	16 15/16	1 9/16	GM	Reg. plant model	VE	C	3	17	GR	2 3/8	18 5/8	C		A	N	128185
									GR	2 3/8	18 5/8	C		A		
28 1/4	16 15/16	1 9/16	GM		VE	C	3	17	GR	3 1/2	18 5/8	C		A	N	128552
									GR	3 1/2	18 5/8	C		A		
28 1/4	16 15/16	1 9/16	GM		VE	C	3	14	GR	2 3/4	18 5/8	C		A	N	128218
									GR	2 3/4	18 5/8	C		A		
28 1/4	16 15/16	2 1/4	GM		VE	C	4	14	GR	2 3/4	18 5/8	C		A	N	128756
									GR	2 3/4	18 5/8	C		A		
28 1/4	17 1/16	1 1/4	GM		VT	C	2	12	GR	2 3/4	18 5/8	C		A	N	122575
									GR	3 1/2	18 5/8	C		A		
28 1/4	17 1/16	1 1/4	GM		VT	C	2	14	GR	2 3/8	18 5/8	7/16		A	N	128150
									GR	2 3/8	18 5/8	7/16		A		
28 1/4	17 1/16	2	CHEV/GMC	CHEV TRK	VT	C	3	12	GR	3 1/2	18 5/8	3/8		A	N	124565
									GR	3 1/2	18 5/8	3/8		A		
28 1/4	17 1/16	2	GM	Reg. plant model	VT	C	3	12	GR	2 3/4	18 5/8	C		A	N	122505
									GR	2 3/4	18 5/8	C		A		
28 1/4	17 1/16	2	GM		VT	C	3	16	GR	2 3/4	18 5/8	C		A	N	128639
									GR	2 3/4	18 5/8	C		A		

Vista-Pro Automotive - Core Catalog

(Cores Sorted by Application)

Height	Width	Depth	Application	Description	Fin Type	Fin Matl	Rows	FPI	BH / TH Type	BH / TH Width	BH / TH Length	BH / TH OHF	BH / TH Bolts	BH / TH Shape	Hdr Support	Part #
GENERAL MOTORS / CHEVY TRUCKS (Cont)																
28 1/4	17 1/16	2	GM		VT	C	3	14	GR	2 3/8	18 5/8	C		A	N	128199
									GR	2 3/8	18 5/8	C		A	N	128199
28 1/4	17 1/16	2	GM		VT	C	3	16	GR	3 7/16	18 5/8	3/8		A	N	128638
									GR	2 3/4	18 5/8	C		A	N	128638
28 1/4	17 1/16	2	GM		VT	C	3	16	GR	3 1/2	18 5/8	3/8		A	N	128640
									GR	3 1/2	18 5/8	3/8		A	N	128640
28 1/4	17 1/16	2 5/8	GMC		VT	C	4	15	GR	3 1/2	18 5/8	C		A	N	124034
									GR	3 1/2	18 5/8	C		A	N	124034
28 1/4	17 1/16	2 5/8	GM	Reg. plant model	VT	C	4	12	GR	3 1/2	18 5/8	C		A	N	122548
									GR	3 1/2	18 5/8	C		A	N	122548
28 1/4	17 1/16	2 5/8	GM		VT	C	4	12	GR	2 3/4	18 5/8	C		A	N	128733
									GR	2 3/4	18 5/8	C		A	N	128733
28 1/4	17 1/16	2 5/8	GM		VT	C	4	12	GR	3 1/2	18 5/8	C		A	N	122603
									GR	2 3/4	18 5/8	C		A	N	122603
28 1/4	19	1 9/16	GM	VE CORE;3R-17 FPI	VE	C	3	17	GR	2 3/8	20 5/8	C		A	N	128187
									GR	2 3/8	20 5/8	C		A	N	128187
28 1/4	19	2 1/4	GM		VE	C	4	18	GR	2 3/4	20 7/8	C		A	N	128804
									GR	2 3/4	20 7/8	C		A	N	128804
28 1/4	19	2 1/4	GM	VE CORE;4R-12 FPI	VE	C	4	14	GR	3 1/2	20 7/8	3/8		A	N	128579
									GR	3 1/2	20 7/8	3/8		A	N	128579
28 1/4	19	2 3/4	GM		VE	C	5	14	GR	3 7/16	20 7/8	C		A	N	128806
									GR	3 7/16	20 7/8	C		A	N	128806
28 1/4	19 1/4	2	CHEV/GMC	CHEV TRK	VT	C	3	15	GR	3 1/2	20 7/8	3/8		A	N	124716
									GR	3 7/16	20 7/8	3/8		A	N	124716
28 1/4	19 1/4	2	GMC		VT	C	3	13	GR	2 3/4	20 7/8	C		A	N	124922
									GR	2 3/4	20 7/8	C		A	N	124922
28 1/4	19 1/4	2 5/8	GM	Reg. plant model	VT	C	4	15	GR	3 1/2	20 7/8	C		A	N	124672
									GR	3 1/2	20 7/8	C		A	N	124672
28 1/4	19 1/4	2 5/8	GM		VT	C	4	12	GR	2 3/4	20 7/8	C		A	N	128663
									GR	2 3/4	20 7/8	C		A	N	128663
28 1/4	19 7/16	1 9/16	GM		VE	C	3	16	GR	3 1/2	20 7/8	C		A	N	128805
									GR	3 1/2	20 7/8	C		A	N	128805
28 1/4	19 7/16	1 9/16	GM		VE	C	3	16	GR	2 3/4	20 7/8	C		A	N	128767
									GR	2 3/4	20 7/8	C		A	N	128767
28 1/4	19 7/16	2 1/4	GM		VE	C	4	14	GR	2 3/4	20 7/8	C		A	N	128803
									GR	2 3/4	20 7/8	C		A	N	128803
28 1/4	20 5/8	2 7/8	GMC		R	C	5	11	GR	3 1/2	20 7/8	C		A	C	281581
									GR	3 1/2	20 7/8	C		A	C	281581
28 1/4	24	3	CHEV/GMC	C/FLO W/SIDE RAILS	B	C	4	7	GR	3 1/2	25 3/4	C		A	C	229570
									GR	3 1/2	25 3/4	C		A	C	229570
28 1/4	24 3/16	3	CHEV/GMC	C 40-80 C/FLO W/SIDE RAILS	T	C	4	10	GR	3 1/2	25 3/4	C		A	C	223081
									GR	3 1/2	25 3/4	C		A	C	223081
28 1/4	24 3/16	1 1/4	GMC TRUCK		VT	C	2	12	GR	3 1/2	25 3/4	C		A	N	124596
									GR	3 1/2	25 3/4	C		A	N	124596
28 1/4	24 3/16	2	GM		VT	C	3	12	GR	3 1/2	25 3/4	1/4		A	N	128750
									GR	3 1/2	25 3/4	1/4		A	N	128750
28 1/4	24 3/16	2 5/8	GMC TRUCK	Reg. plant model	VT	C	4	13	GR	3 1/2	25 3/4	C		A	N	122585
									GR	3 1/2	25 3/4	C		A	N	122585
28 1/4	24 3/16	2 5/8	GM		VT	C	4	12	GR	3 1/2	25 3/4	C		A	N	128751
									GR	3 1/2	25 3/4	C		A	N	128751
28 1/4	26 1/4	2 3/8	CHEV/GMC	TOP KICK C/FLO W/SIDE RAILS	R	C	4	10	GR	3 7/16	28	3/8		A	C	226349
									GR	3 7/16	28	3/8		A	C	226349
28 1/4	26 3/8	2 5/8	GMC TRUCK	Reg. plant model	VT	C	4	12	GR	3 1/2	28	C		A	N	128290
									GR	3 1/2	28	C		A	N	128290

Vista-Pro Automotive - Core Catalog

(Cores Sorted by Application)

Height	Width	Depth	Application	Description	Fin Type	Fin Matl	Rows	FPI	BH/TH Type	BH/TH Width	BH/TH Length	BH/TH OHF	BH/TH Bolts	BH/TH Shape	Hdr Support	Part #
GENERAL MOTORS / CHEVY TRUCKS (Cont)																
28 1/4	26 3/8	2 5/8	GM		VT	C	4	16	GR GR	3 1/2 3 1/2	28 28	C C		A A	N	128526
28 1/4	27 1/2	1 3/4	CHEV/GMC	ASTRO 7500	R	C	3	10	BL BL	7 1/8 5 3/8	30 1/2 30 1/2	2 7/8 2	42 42	A A	C	226350
28 1/4	27 1/2	2 3/8	CHEV/GMC	ASTRO 7500	R	C	4	10	BL BL	7 1/8 5 3/8	30 1/2 30 1/2	C C	46 42	A A	C	226351
28 1/4	27 1/2	2 5/8	GM		VT	C	4	14	GR GR	3 1/2 3 1/2	28 13/16 28 13/16	C C		A A	N	128531
28 1/4	24 1/4	2	GMC TRUCK		VT	C	3	13	GR GR	3 1/2 3 1/2	25 3/4 25 3/4	1/4 1/4		A A	N	122523
28 3/8	19 3/8	2 1/4	GM		VE	C	4	16	GR GR	3 1/2 3 1/2	20 7/8 20 7/8	C C		A A	N	122113
28 3/8	25 5/16	2 1/4	CHEV/GMC	C/FLO	T	C	3	10	GR GR	3 1/2 3 1/2	25 3/4 25 3/4	C C		A A	C	265206
28 3/8	25 5/16	3	CHEV/GMC	V-8 350-400 C/FLO	T	C	4	10	GR GR	3 1/2 3 1/2	25 3/4 25 3/4	C C		A A	C	265205
28 3/8	28 1/8	1 3/4	CHEV/GMC	ASTRO 7500	R	C	3	11	BL BL	7 1/8 5 1/4	30 1/2 30 1/2	2 1/4 1 3/8	46 42	A A	C	226352
28 3/8	28 1/8	2 1/4	CHEV/GMC	7500	T	C	3	9	BL BL	7 1/8 5 1/4	30 1/2 30 1/2	2 1/4 1 1/4	46 42	A A	C	263962
28 3/8	28 1/8	2 7/8	CHEV/GMC	9500	R	C	5	10	BL BL	7 1/8 5 1/4	30 1/2 30 1/2	C C	46 42	A A	C	226113
28 3/8	28 1/8	3	CHEV/GMC	7500 V6 DIESEL	T	C	4	9	BL BL	7 1/8 5 1/4	30 1/2 30 1/2	C C	46 42	A A	C	265508
29	23 5/8	2	GMC TRUCK		VT	C	3	12	BU BU	5 3/8 3 3/8	23 3/4 23 3/4	C C		A A	N	122416
29	23 5/8	2	GM		VT	C	3	12	BU BU	4 3/8 3 3/8	23 3/4 23 3/4	C C		A A	N	122432
29	23 5/8	2 5/8	GM		VT	C	4	12	BU BU	4 3/8 3 3/8	23 3/4 23 3/4	C C		A A	N	122418
29 3/4	23 5/8	2	GM		VT	C	3	12	BU GR	4 3/8 3 3/8	23 3/4 23 3/4	C C		A A	N	124722
29 3/4	23 5/8	2 5/8	GM		VT	C	4	12	BU GR	4 3/8 3 3/8	23 3/4 23 3/4	C C		A A	N	124723
30	28 11/16	3 3/4	CHEV/GMC	PD4104	T	C	5	9	BL BL	6 1/4 6 1/4	30 3/4 30 3/4	C C	36 36	F F	C	270355
30	28 3/4	2 7/8	CHEV/GMC	PD4104	R	C	5	11	BL BL	6 1/4 6 1/4	30 3/4 30 3/4	1 3/4 1 3/4	36 36	F F	C	226358
30	29 1/4	3 3/4	CHEV/GMC	PD4104	T	C	5	8	BL BL	6 1/4 6 1/4	30 3/4 30 3/4	C C	36 36	F F	C	260355
30	29 3/8	3 3/4	CHEV/GMC	4104 BUS HVY T/BTM HDRS	X	C	5	9	BH BH	6 1/4 6 1/4	30 3/4 30 3/4	C C	36 36	F F	C	266051
30	29 11/16	2 5/8	CHEV/GMC		VT	C	4	14	GR GR	3 3/8 3 3/8	31 7/8 31 7/8	C C		A A	N	128888
30	43 1/8	2 3/8	CHEV/GMC	GENERAL 15601472 LOW FLOW CAN USE 284772 DIMPLED TUBE	R	C	4	11	BL BL	7 7	45 1/4 45 1/4	1 5/8 1 5/8	60 60	B B	CC	226001
30	43 1/8	2 7/8	CHEV/GMC	GENERAL	R	C	5	11	BL BL	7 7	45 1/4 45 1/4	1 5/8 1 5/8	60 60	B B	CC	226114
30 1/2	16 15/16	1	GM		VE	C	2	16	GR GR	2 3/8 2 3/8	18 5/8 18 5/8	3/8 3/8		A A	N	128577
30 1/2	16 15/16	1 9/16	GM	VE CORE;3R-14 FPI	VE	C	3	14	GR GR	2 3/8 2 3/8	18 5/8 18 5/8	C C		A A	N	128772
30 1/2	16 15/16	1 9/16	GM		VE	C	3	14	GR GR	2 3/4 2 3/4	18 5/8 18 5/8	3/8 3/8		A A	N	128296

Vista-Pro Automotive - Core Catalog

(Cores Sorted by Application)

Height	Width	Depth	Application	Description	Fin Type	Fin Matl	Rows	FPI	BH/TH Type	BH/TH Width	BH/TH Length	BH/TH OHF	BH/TH Bolts	BH/TH Shape	Hdr Support	Part #	
GENERAL MOTORS / CHEVY TRUCKS (Cont)																	
30	1/2	17 1/16	2 5/8	GM		VT	C	4	12	GR	2 7/8	18 5/8	C		A	N	128741
										GR	2 7/8	18 5/8	C		A		
30	1/2	17 3/8	2 1/4	GM		VE	C	4	16	GR	3 1/2	18 5/8	5/8		A	N	128763
										GR	3 1/2	18 5/8	5/8		A		
31		25 5/16	2 5/8	CHEV/GMC		VT	C	4	12	GR	3 1/2	25 3/4	C		A	N	128863
										GR	3 1/2	25 3/4	C		A		
32		25 5/16	2 5/8	CHEV/GMC		VT	C	4	13	GR	3 1/2	25 3/4	C		A	N	122673
										GR	3 1/2	25 3/4	C		A		
32	1/2	17 1/16	2	GM		VT	C	3	16	GR	2 3/4	18 5/8	C		A	N	128651
										GR	2 3/4	18 5/8	C		A		
32	1/2	17 1/16	2 5/8	GM		VT	C	4	12	GR	2 3/4	18 5/8	C		A	N	122624
										GR	2 3/4	18 5/8	C		A		
32	1/2	27 1/2	2 3/8	CHEV/GMC	ASTRO 684230, 2005701 TEMPLATE #8	R	C	4	10	BL	10 3/8	29 5/8	1 1/2	44	A	C	226364
										BL	6 1/4	29 5/8	1 1/4	40	A		
32	1/2	27 1/2	2 3/8	CHEV/GMC	ASTRO TEMPLATE #10	R	C	4	11	BL	10 3/8	29 5/8	1 5/8	44	A	C	226365
										BL	6 1/4	29 5/8	1 3/8	40	A		
32	1/2	27 1/2	2 7/8	CHEV/GMC	ASTRO	R	C	5	10	BL	6 1/8	29 7/16	1 7/16	38	A	C	226366
										BL	6 1/8	29 7/16	1 7/16	40	A		
32	1/2	27 1/2	2 7/8	CHEV/GMC	ASTRO 9500 TEMPLATE #10	R	C	5	8	BL	10 3/8	29 5/8	1 1/4	44	A	C	226369
										BL	6 1/4	29 5/8	1 1/4	40	A		
32	1/2	27 1/2	2 7/8	CHEV/GMC	ASTRO 9500 TEMPLATE #8	R	C	5	10	BL	10 3/8	29 5/8	1 1/2	44	A	C	226370
										BL	6 1/4	29 5/8	1 1/4	40	A		
32	1/2	28 1/8	2 1/4	CHEV/GMC	9000	T	C	3	9	BL	7	30 1/2	2 7/8	46	A	C	263878
										BL	5 1/2	30 1/2	2	42	A		
32	1/2	28 1/8	2 7/8	CHEV/GMC	ASTRO 9500	R	C	5	10	BL	7	30 1/2	C	46	A	C	226330
										BL	5 1/2	30 1/2	C	42	A		
32	3/4	42 3/16	3	CHEV/GMC	GENERAL HVY BTM HDR	T	C	4	11	BL	7	45 1/4	1 3/4	60	B	CC	223125
										BH	7	45 1/4	1 3/4	60	B		
32	3/4	42 1/2	2 1/4	GMC TRUCK	GENERAL LOW FLOW CAN USE 284021 DIMPLED TUBE	VH	C	3	15	BL	7	45 1/4	1 5/8	60	B	N	251022
										BL	7	45 1/4	1 5/8	60	B		
32	3/4	42 1/2	2 3/8	CHEV/GMC	GENERAL LOW FLOW CAN USE 284021 DIMPLED TUBE	R	C	4	11	BL	7	45 1/4	1 5/8	60	B	CC	226015
										BL	7	45 1/4	1 5/8	60	B		
32	3/4	42 1/2	2 7/8	CHEV/GMC	GENERAL LOW FLOW CAN USE 284025 DIMPLED TUBE	R	C	5	11	BL	7	45 1/4	1 5/8	60	B	CC	226016
										BL	7	45 1/4	1 5/8	60	B		
32	3/4	42 1/2	2 7/8	CHEV/GMC	GENERAL	R	C	5	11	BL	7	45 1/4	1 5/8	60	B	CC	226116
										BL	7	45 1/4	1 5/8	60	B		
32	3/4	42 1/2	2 7/8	CHEV/GMC	GENERAL LOW FLOW HDRS CTRDR PER CHAS BRASWELL DIMPLED TUBE	R	C	5	11	BL	7	45 1/4	1 5/8	60	B	CC	226043
										BL	7	45 1/4	1 5/8	60	B		
32	3/4	42 1/2	3	GMC TRUCK	GENERAL LOW FLOW CAN USE 284025 DIMPLED TUBE	VH	C	4	15	BL	7	45 1/4	1 5/8	60	B	N	251023
										BL	7	45 1/4	1 5/8	60	B		
32	3/4	42 3/4	2 1/4	CHEV/GMC	GENERAL ULTRA-FUSED LOW FLOW CAN USE 251022 DIMPLED TUBE	VH	C	3	13	BL	7	45 1/4	1 5/8	60	B	N	284021
										BL	7	45 1/4	1 5/8	60	B		
33	1/4	31 7/8	2 7/8	CHEV/GMC	BUS PD4106	R	C	5	10	BL	6 1/4	33 7/8	C	42	A	C	226377
										BL	6 1/4	33 7/8	C	42	A		
33	1/4	31 7/8	3 7/16	CHEV/GMC	BUS 4106 HVY T/BTM HDRS	S	C	6	8	BH	6 1/4	33 7/8	C	42	A	C	266143
										BH	6 1/4	33 7/8	C	42	A		
33	1/4	31 7/8	3 3/4	CHEV/GMC	BUS 4106	X	C	5	9	BL	6 1/4	33 7/8	C	42	A	C	281614
										BL	6 1/4	33 7/8	C	42	A		
34		16 15/16	2 1/4	GM		VE	C	4	14	GR	3 1/2	18 5/8	3/8		A	N	128175
										GR	3 1/2	18 5/8	3/8		A		
34		16 15/16	2 1/4	GM	VE CORE;4R-14 FPI	VE	C	4	14	GR	3 7/16	18 5/8	C		A	N	128585
										GR	3 7/16	18 5/8	C		A		
34		16 15/16	2 3/4	GM		VE	C	5	14	GR	3 7/16	18 5/8	FF		A	N	128817
										GR	3 7/16	18 5/8	FF		A		

Vista-Pro Automotive - Core Catalog

(Cores Sorted by Application)

Height	Width	Depth	Application	Description	Fln Type	Fln Matl	Rows	FPI	BH/TH Type	BH/TH Width	BH/TH Length	BH/TH OHF	BH/TH Bolts	BH/TH Shape	Hdr Support	Part #
GENERAL MOTORS / CHEVY TRUCKS (Cont)																
34	17 1/16	2 5/8	GM		VT	C	4	12	GR	2 3/4	18 5/8	C		A	N	122612
									GR	3 1/2	18 5/8	C		A	N	122623
34	17 1/16	2 5/8	GM		VT	C	4	12	GR	2 3/4	18 5/8	C		A	N	122623
									GR	2 3/4	18 5/8	C		A	N	124931
34	17 1/16	2 5/8	GM		VT	C	4	15	GR	3 1/2	18 5/8	C		A	N	124931
									GR	3 1/2	18 5/8	C		A	N	128586
34	17 3/8	1 9/16	GM		VE	C	3	14	GR	3 7/16	18 5/8	7/16		A	N	128586
									GR	3 7/16	18 5/8	7/16		A	N	128299
34	19	1 9/16	CHEV/GMC		VE	C	3	14	GR	3 1/2	20 7/8	C		A	N	128299
									GR	3 1/2	20 7/8	C		A	N	128758
34	19	1 9/16	GM		VE	C	3	16	GR	2 3/8	20 5/8	C		A	N	128758
									GR	2 3/8	20 5/8	C		A	N	128280
34	19	2 1/4	GM	VE CORE;4R-14 FPI	VE	C	4	14	GR	3 1/2	20 7/8	7/16		A	N	128280
									GR	3 1/2	20 7/8	7/16		A	N	128818
34	19	2 3/4	GM		VE	C	5	14	GR	3 1/2	20 7/8	3/8		A	N	128818
									GR	3 1/2	20 7/8	3/8		A	N	128816
34	19 1/4	2	CHEV/GMC		VT	C	3	12	GR	3 1/2	20 7/8	3/8		A	N	128816
									GR	3 1/2	20 7/8	3/8		A	N	128148
34	19 1/4	2 5/8	GM	TRUCK	VT	C	4	12	GR	3 1/2	20 7/8	C		A	N	128148
									GR	3 7/16	20 7/8	C		A	N	124556
34	24 3/16	2	CHEV/GMC	CHEV TRK	VT	C	3	12	GR	3 1/2	25 3/4	1/4		A	N	124556
									GR	3 1/2	25 3/4	1/4		A	N	124557
34	24 3/16	2 5/8	CHEV/GMC	CHEV TRK	VT	C	4	12	GR	3 1/2	25 3/4	1/2		A	N	124557
									GR	3 1/2	25 3/4	1/2		A	N	128753
34	24 3/16	2 5/8	GM		VT	C	4	12	GR	3 1/2	25 3/4	C		A	N	128753
									GR	3 1/2	25 3/4	C		A	N	226379
36 1/4	33 1/8	2 7/8	CHEV/GMC	RTS BUS	R	C	5	9	BL	7	35	C	44	A	C	226379
									BL	7	35	C	44	A	C	226130
36 1/4	33 1/8	3 7/16	CHEV/GMC	RTS BUS CAN USE 282765	R	C	6	9	BL	7	35	C	44	A	C	226130
									BL	7	35	C	44	A	C	281925
36 1/4	33 1/8	3 3/4	CHEV/GMC	BUS 2016781	X	C	5	10	BL	7	35	C	44	A	C	281925
									BL	7	35	C	44	A	C	226380
36 1/4	33 1/8	3 15/16	CHEV/GMC	RTS BUS 1056463-00	R	C	7	11	BL	7	35	C	44	A	C	226380
									BL	7	35	C	44	A	C	229207
36 1/4	33 1/8	4 7/16	GMC TRUCK	DETROIT DIESEL 3S41609	S	C	8	11	BL	7	35	C	44	A	C	229207
									BL	7	35	C	44	A	C	124956
37 1/4	24 3/16	2	GM		VT	C	3	12	GR	3 1/2	25 3/4	1/4		A	N	124956
									GR	3 1/2	25 3/4	1/4		A	N	124957
37 1/4	24 3/16	2 5/8	GM		VT	C	4	12	GR	3 1/2	25 3/4	C		A	N	124957
									GR	3 1/2	25 3/4	C		A	N	226381
37 1/4	25 5/8	1 3/4	CHEV/GMC	BRUIN, KODIAK C/FLO	R	C	3	11	GR	3 1/2	25 3/4	7/16		A	C	226381
									GR	3 1/2	25 3/4	7/16		A	C	226118
37 1/4	25 5/8	2 3/8	CHEV/GMC	BRUIN C/FLO	R	C	4	11	GR	3 1/2	25 3/4	3/16		A	C	226118
									GR	3 1/2	25 3/4	3/16		A	C	226121
39 1/2	27 1/2	2 3/8	CHEV/GMC	ASTRO HVY BTM HDR	R	C	4	11	BL	7 1/8	30 1/2	C	46	A	C	226121
									BH	5 3/8	30 1/2	C	42	A	C	226382
39 1/2	27 1/2	2 3/8	CHEV/GMC	ASTRO TEMPLATE # 7	R	C	4	11	BL	10 3/8	29 5/8	1 5/8	44	A	C	226382
									BL	6 1/4	29 5/8	1 3/8	40	A	C	226120
39 1/2	27 1/2	2 7/8	CHEV/GMC	ASTRO 9500 TEMPLATE # 8	R	C	5	10	BL	10 3/8	29 5/8	1 1/2	44	A	C	226120
									BL	6 1/4	29 5/8	1 1/2	40	A	C	226331
39 1/2	27 1/2	2 7/8	CHEV/GMC	ASTRO TEMPLATE #10	R	C	5	10	BL	10 3/8	29 5/8	1 1/2	44	A	C	226331
									BL	6 1/4	29 5/8	1 1/2	40	A	C	226383
39 1/2	27 1/2	2 7/8	CHEV/GMC	ASTRO TEMPLATE #7	R	C	5	11	BL	10 3/8	29 5/8	1 5/8	44	A	C	226383
									BL	6 1/4	29 5/8	1 3/8	40	A	C	

Vista-Pro Automotive - Core Catalog

(Cores Sorted by Application)

Height	Width	Depth	Application	Description	Fin Type	Fin Matl	Rows	FPI	BH / TH Type	BH / TH Width	BH / TH Length	BH / TH OHF	BH / TH Bolts	BH / TH Shape	Hdr Support	Part #
GENERAL MOTORS / CHEVY TRUCKS (Cont)																
39 1/2	27 9/16	3	CHEV/GMC	ASTRO 9500 TEMPLATE #8	T	C	4	10	BL BL	10 3/8 6 1/4	29 5/8 29 5/8	1 1/2 1 1/2	44 40	A A	C	265192
42	19 3/8	4 7/16	CHEV/GMC	BUS; RTS 06	R	C	8	11	BL BL	8 8	22 1/4 22 1/4	C C	38 38	A A	C	225705
44	26 7/8	2 7/8	CHEV/GMC	BRIGADIER	R	C	5	11	BL BL	6 1/8 6 1/8	29 1/2 29 1/2	1 7/8 1 7/8	40 40	A A	C	226386
44	27 3/8	3	CHEV/GMC	BRIGADIER ULTRA-FUSED LOW FLOW CAN USE 226025 DIMPLED TUBE	VH	C	4	14	BL BL	7 6 3/8	29 7/8 29 7/8	1 9/16 1 5/16	42 42	XX XX	N	284709
44	27 1/2	2 7/8	CHEV/GMC	BRIGADIER LOW FLOW CAN USE 284709 DIMPLED TUBE	R	C	5	11	BL BL	7 6 3/8	29 7/8 29 7/8	1 9/16 1 5/16	42 42	A A	C	226025
44	27 1/2	2 7/8	CHEV/GMC	ASTRO TEMPLATE #8	R	C	5	11	BL BL	10 3/8 6 1/4	29 5/8 29 5/8	1 1/2 1 1/2	44 40	A A	C	226122
44	27 1/2	2 7/8	CHEV/GMC	BRIGADIER 15511855	R	C	5	11	BL BL	7 6 3/8	29 7/8 29 7/8	1 3/4 1 3/8	42 42	A A	C	226248
44	27 1/2	2 7/8	CHEV/GMC	ASTRO TEMPLATE #10	R	C	5	10	BL BL	10 3/8 6 1/4	29 5/8 29 5/8	1 1/2 1 1/2	44 40	A A	C	226332
44	27 1/2	2 7/8	CHEV/GMC	BRIGADIER	R	C	5	10	BL BL	6 3/8 6 3/8	29 7/8 29 7/8	1 3/8 1 3/8	42 42	A A	C	226388
44	27 1/2	2 7/8	CHEV/GMC	BRIGADIER	R	C	5	11	BL BL	7 7	29 7/8 29 7/8	1 5/8 1 5/8	42 42	A A	C	226389
44	27 1/2	2 7/8	CHEV/GMC	ASTRO 9500 TEMPLATE #10	R	C	5	10	BL BL	10 3/8 6 1/4	29 5/8 29 5/8	1 5/8 1 3/8	44 40	A A	C	226390
44	27 1/2	2 7/8	CHEV/GMC	ASTRO TEMPLATE #7	R	C	5	10	BL BL	10 3/8 6 1/4	29 5/8 29 5/8	1 5/8 1 3/8	44 40	A A	C	226391
44	27 1/2	3	GMC TRUCK	BRIGADIER LOW FLOW CAN USE 284709 DIMPLED TUBE	VH	C	4	15	BL BL	7 6 3/8	29 7/8 29 7/8	1 3/4 1 3/8	42 42	A A	N	251030
44	27 1/2	3	GMC TRUCK	BRIGADIER CAN USE 226248	VH	C	4	14	BL BL	7 6 3/8	29 7/8 29 7/8	1 3/4 1 3/8	42 42	A A	N	251100
44	27 1/2	3 7/16	CHEV/GMC	BRIGADIER	R	C	6	11	BL BL	7 6 3/8	29 7/8 29 7/8	1 3/4 1 3/8	42 42	A A	C	226392
44	27 1/2	3 7/16	CHEV/GMC	ASTRO TEMPLATE #7	R	C	6	10	BL BL	10 3/8 6 1/4	29 5/8 29 5/8	1 5/8 1 3/8	44 40	A A	C	226393
44	27 9/16	3	CHEV/GMC	BRIGADIER	T	C	4	10	BL BL	7 6 3/8	29 7/8 29 7/8	1 5/8 1 5/8	42 42	A A	C	265569
44	28 1/8	2 7/8	CHEV/GMC	BRIGADIER	R	C	5	11	BL BL	7 6 3/8	29 7/8 29 7/8	1 5/8 1 3/8	42 42	B B	C	226395
44	31 7/8	2 7/8	CHEV/GMC	BRIGADIER	R	C	5	11	BL BL	7 6 5/8	33 33	1 5/8 1 5/8	42 42	A A	C	226396
46	28 11/16	3	CHEV/GMC	ASTRO TEMPLATE #9	T	C	4	10	BL BL	10 3/8 6 7/8	31 1/4 31 1/4	1 1/2 1 1/2	46 42	A A	C	265401
46	28 3/4	2 7/8	CHEV/GMC	ASTRO HVY BTM HDR TEMPLATE #9	R	C	5	10	BL BH	10 3/8 6 7/8	31 1/4 31 1/4	1 1/2 1 1/2	46 42	A A	C	226333
GRADALL																
29 3/8	26 1/4	2 15/16	GRADALL	1100 CAT ENG	Z	C	4	9	GR GR	4 4	26 7/8 26 7/8	3/16 3/16		A A	C	289981
29 3/8	26 7/16	3	GRADALL	1100 CAT ENGINE	T	C	4	8	GR GR	4 4	26 7/8 26 7/8	3/16 3/16		A A	C	279250
GREMLIN																
16 7/8	24 3/16	2	GREMLIN		VT	C	3	12	GR GR	2 1/4 2 1/4	24 24	C C		A A	N	124698
GROVE WORLDWIDE																
26 7/16	29 1/4	4 1/2	GROVE WORLDWIDE		T	C	6	9	GR GR	5 3/8 5 3/8	29 7/8 29 7/8	1/8 1/8		A A	C	223243

Vista-Pro Automotive - Core Catalog

(Cores Sorted by Application)

Height	Width	Depth	Application	Description	Fin Type	Fin Matl	Rows	FPI	BH/TH Type	BH/TH Width	BH/TH Length	BH/TH OHF	BH/TH Bolts	BH/TH Shape	Hdr Support	Part #	
GROVE WORLDWIDE (Cont)																	
26	7/8	28 3/4	4 7/16	GROVE WORLDWIDE	BRASS FINS	Z	B	6	9	GR	5 3/8	29 5/8	5/16		A	C	286568
										GR	5 3/8	29 5/8	5/16		A	C	
27	1/8	28 1/8	3 3/4	GROVE WORLDWIDE		X	C	5	11	GR	4 7/8	28 1/4	1/4		A	C	289813
										GR	4 7/8	28 1/4	1/4		A	C	
27	7/8	28 1/8	3 3/4	GROVE WORLDWIDE	5.22773E+12	X	C	5	9	GR	6 1/2	28 3/8	11/16		A	C	286758
										GR	4 7/8	28 3/8	11/16		A	C	
28	1/2	27 1/2	4 7/16	GROVE WORLDWIDE	CRANE BRASS FINS	Z	B	6	9		5	27 3/4	C		0	C	286569
											5	27 3/4	C		0	C	
33	15/16	33 3/16	4 1/2	GROVE WORLDWIDE	CRANE	T	C	6	8	BL	7 1/4	36	C	48	A	C	223228
										BL	7 1/4	36	C	48	A	C	
35		35	2 7/8	GROVE WORLDWIDE	800 CRANE W/CUMMINS ENGINE HVY BTM HDR	S	C	5	9	BL	7 3/4	36	1 5/8	48	A	C	272879
										BH	7 3/4	36	1 5/8	48	A	C	
HAHN																	
35	1/2	26 1/4	3 7/16	HAHN	FIRE TRUCK HVY BTM HDR	R	C	6	11	BL	7	28 7/8	C	40	A	C	226509
										BH	7	28 7/8	C	40	A	C	
HALLIBURTON																	
28	3/8	25 7/8	3	HALLIBURTON	3-53 DETROIT HVY T/BTM HDR	T	C	4	9	BL	6 1/2	28 1/2	C	38	A	C	272677
										BH	6 1/2	28 1/2	C	38	A	C	
43		38 1/4	5 1/4	HALLIBURTON	HVY T/BTM HDRS	T	C	7	9	BH	8 1/4	41 1/4	C	50	A	C	272880
										BH	8 1/4	41 1/4	C	50	A	C	
43		38 13/16	5 1/4	HALLIBURTON	HVY T/BTM HDRS	T	C	7	8	BH	8 1/4	41 1/4	C	50	A	C	272683
										BH	8 1/4	41 1/4	C	50	A	C	
43		42 3/16	3 3/4	HALLIBURTON	HVY T/BTM HDRS	T	C	5	9	BH	8	45 1/2	C	54	A	CC	272684
										BH	8	45 1/2	C	54	A	CC	
60		43 5/16	5 1/4	HALLIBURTON	HVY T/BTM HDRS	T	C	7	8	BH	8 3/4	45 1/2	C	54	A	CC	272687
										BH	8 3/4	45 1/2	C	54	A	CC	
HAPPY YOUNG																	
35		34 7/8	3 3/4	HAPPY YOUNG	36-42 HVY T/BTM HDRS	T	C	5	7	BH	6 1/2	37 5/8	C	38	A	C	270207
										BH	6 1/2	37 5/8	C	38	A	C	
37		37 1/2	5 3/16	HAPPY YOUNG	HVY BTM HDR BRASS FINS 4 CORES PER RAD	Z	B	7	10	BL	8 3/4	39 7/8	C	50	A	C	288259
										BH	8 3/4	39 7/8	C	50	A	C	
60		59 5/8	3	HAPPY YOUNG	HVY T/BTM HDRS	T	C	4	8	BH	6 1/2	63 1/4	C	58	A	CC	264320
										BH	6 1/2	63 1/4	C	58	A	CC	
HENDRICKSON TRUCK																	
36	7/8	30 3/8	4 1/2	HENDRICKSON TRUCK		T	C	6	10	BL	7 3/4	32	1 5/8	46	A	C	265557
										BL	7 3/4	32	1 5/8	46	A	C	
HERCULES ENGINE																	
14	1/2	15 3/4	2 1/4	HERCULES ENGINE		T	C	3	6	GR	6	15 5/8	1/4		A	N	261007
										GR	2 1/2	15 5/8	1/4		A	N	
18	1/8	19 1/8	3 3/4	HERCULES ENGINE		T	C	5	10	GR	4	20	C		A	N	279259
										GR	4	20	C		A	N	
34		25	3 15/16	HERCULES ENGINE	4800 40-3902003	S	C	7	10	GR	4 5/16	25 3/4	C		A	C	229077
										GR	4 5/16	25 3/4	C		A	C	
HESTON																	
24		25 5/8	2 7/8	HESTON	WIND ROVER	S	C	5	6	GR	3 3/8	25 3/4	C		A	C	265994
										GR	3 3/8	25 3/4	C		A	C	
HOBART WELDER																	
20		19 3/8	2 3/16	HOBART WELDER		Z	C	3	9	GR	4	19 7/8	3/16		A	N	289533
										GR	4	19 7/8	3/16		A	N	
20		20	2 1/4	HOBART WELDER		X	C	3	8	BL	6 1/4	23	1 1/4	30	F	C	280445
										BL	6 1/4	23	1 1/4	30	F	C	
20		20 1/4	2 1/4	HOBART WELDER		T	C	3	8	BL	6 1/4	23	C	30	F	C	223269
										BL	6 1/4	23	C	30	F	C	

Vista-Pro Automotive - Core Catalog

(Cores Sorted by Application)

Height	Width	Depth	Application	Description	Fin Type	Fin Matl	Rows	FPI	BH / TH Type	BH / TH Width	BH / TH Length	BH / TH OHF	BH / TH Bolts	BH / TH Shape	Hdr Support	Part #
HOBART WELDER (Cont)																
20	20 1/4	3	HOBART WELDER		T	C	4	8	BL BL	6 1/4 6 1/4	23 23	C C	30 30	F F	C	223270
HONDA																
8 3/4	8 13/16	2	HONDA		VT	C	3	12	GR GR	2 3/8 2 3/8	9 3/8 9 3/8	C C		A A	N	128495
11	9 7/8	2	HONDA		VT	C	3	12	GR GR	2 1/2 2 1/2	10 1/2 10 1/2	C C		A A	N	124846
11 7/8	15 1/4	1 9/16	HONDA		VE	C	3	17	GR GR	2 1/2 2 1/2	15 3/8 15 3/8	C C		A A	N	128228
11 7/8	15 3/8	1 1/4	HONDA		VT	C	2	13	GR GR	1 13/16 1 13/16	15 5/16 15 5/16	C C		A A	N	124707
11 7/8	15 3/8	2	HONDA		VT	C	3	14	GR GR	2 1/2 2 1/2	15 3/8 15 3/8	C C		A A	N	124847
12 7/8	20 7/8	1 1/4	HONDA		VT	C	2	14	GR GR	1 3/4 1 3/4	21 21	C C		A A	N	124849
13 3/4	19 1/4	1 1/4	HONDA		VT	C	2	12	GR GR	2 1/2 2	19 1/4 19 1/4	C C		A A	N	124834
14 3/4	19 1/4	1 1/4	HONDA		VT	C	2	14	GR GR	1 3/4 1 3/4	19 5/8 19 5/8	C C		A A	N	124967
15 3/4	12 5/8	1 1/4	HONDA		VT	C	2	12	GR GR	1 3/4 1 3/4	12 7/16 12 7/16	C C		A A	N	128119
20 1/2	12 5/8	1 1/4	HONDA		VT	C	2	12	GR GR	1 3/4 1 3/4	12 7/16 12 7/16	C C		A A	N	124973
HUBER																
17 1/4	19 11/16	3	HUBER		T	C	4	6	GR GR	5 3 3/8	20 20	3/16 3/16		A A	N	261102
HYUNDAI																
12 3/4	16 1/2	2	HYUNDAI		VT	C	3	14	GR GR	2 1/2 2 1/2	16 13/16 16 13/16	C C		A A	N	128587
IMPERIAL																
18 1/8	27 1/2	2	IMPERIAL		VT	C	3	12	GR GR	3 2 11/16	27 1/4 27 1/4	C C		A A	N	122560
19 3/4	27 1/2	2	IMPERIAL		VT	C	3	14	GR GR	2 11/16 2 11/16	27 1/4 27 1/4	C C		A A	N	124798
INGERSOLL RAND																
20 5/8	21 1/4	1 3/4	INGERSOLL-RAND	SD40 59878819	S	C	3	8	GR GR	3 7/16 3 7/16	21 15/16 21 15/16	1/8 1/8		A A	N	229080
23 1/8	22 9/16	1 1/4	INGERSOLL-RAND		VT	C	2	12	GR GR	3 1/2 3 1/2	23 3/4 23 3/4	C C		A A	N	122664
23 1/8	22 9/16	2	INGERSOLL-RAND		VT	C	3	12	GR GR	3 1/2 3 1/2	23 3/4 23 3/4	C C		A A	N	122663
23 1/8	23 1/8	1 3/4	INGERSOLL-RAND	100-175 COMPRESSOR 35312156	S	C	3	9	GR GR	3 7/16 3 7/16	23 3/4 23 3/4	C C		A A	N	229081
25 3/4	25 5/16	3	INGERSOLL-RAND		T	C	4	10	GR GR	3 7/16 3 7/16	25 3/4 25 3/4	C C		A A	C	279282
25 3/4	25 5/8	2 3/8	INGERSOLL-RAND	59695692	S	C	4	9	GR GR	3 7/16 3 7/16	25 3/4 25 3/4	1/4 1/4		A A	C	229082
25 3/4	25 5/8	2 7/8	INGERSOLL-RAND	175-250 59624320, 59970954	S	C	5	10	GR GR	3 7/16 3 7/16	25 3/4 25 3/4	C C		A A	C	229083
26 1/8	22 1/2	1 1/4	INGERSOLL-RAND		R	C	2	10	GR GR	3 5/8 3 5/8	24 1/4 24 1/4	1/4 1/4		A A	C	226514
27	29 13/16	2 1/4	INGERSOLL-RAND	DR-250	T	C	3	9	GR GR	4 5/8 4 5/8	31 1/8 31 1/8	3/16 3/16		A A	C	261155

Vista-Pro Automotive - Core Catalog

(Cores Sorted by Application)

Height	Width	Depth	Application	Description	Fin Type	Fin Matl	Rows	FPI	BH/TH Type	BH/TH Width	BH/TH Length	BH/TH OHF	BH/TH Bolts	BH/TH Shape	Hdr Support	Part #
INGERSOLL RAND (Cont)																
39 3/8	38 3/4	2 3/8	INGERSOLL-RAND	HVY BTM HDR	R	C	4	8	BL BH	6 6	41 41	C C	48 48	A A	C	226516
40	6 3/16	2 1/4	INGERSOLL-RAND	R-600 SECTIONAL	T	C	3	9	GR GR	2 3/4 2 3/4	6 6	3/16 3/16		A A	C	261157
42	52 1/2	3 7/16	INGERSOLL-RAND	HVY BTM HDR	R	C	6	9	BL BH	6 6	53 7/8 53 7/8	C C	66 66	A A	CC	226518
44 1/2	25	3 7/16	INGERSOLL-RAND	A-900 CFM 36732873 HVY T/BTM HDRS	R	C	6	11	BH BH	6 7/8 6 7/8	27 1/4 27 1/4	C C	34 34	A A	C	226519
45	45	3 11/16	INGERSOLL-RAND	75-D WAUKESHA	Z	C	5	11	BL BL	7 1/4 7 1/4	47 1/2 47 1/2	2 1/8 2 1/8	54 54	A A	CC	281833
46	47 1/2	2 3/8	INGERSOLL-RAND	HVY BTM HDR	R	C	4	8	BL BH	6 6	49 7/8 49 7/8	C C	62 62	A A	CC	226520
48	27 1/2	2 7/8	INGERSOLL-RAND	COMPRESSOR 5 STIFFENING HOLES T/HDR	R	C	5	9	BL BL	10 1/4 6 1/8	29 7/16 29 7/16	1 13/16 1 1/2	44 40	A A	C	226521
50	52 1/2	3 7/16	INGERSOLL-RAND	1200 CFM HVY T/BTM HDRS	R	C	6	11	BH BH	6 6	53 7/8 53 7/8	C C	66 66	A A	CC	226523
54 1/2	54 3/8	4 7/16	INGERSOLL-RAND	DM30 ROCK DRILL HVY T/BTM HDRS BRASS FINS	Z	B	6	9	BH BH	7 1/8 7 1/8	57 57	C C	64 64	A A	CC	285209
60	65	2 3/8	INGERSOLL-RAND	HVY T/BTM HDRS	R	C	4	8	BH BH	7 7	67 3/8 67 3/8	C C	76 76	A A	CC	226524
INTERNATIONAL																
15 5/8	17 1/16	1 1/4	INTERNATIONAL		VT	C	2	12	GR GR	3 3	16 3/4 16 3/4	C C		A A	N	128523
16 1/8	16 1/2	2	INTERNATIONAL		VT	C	3	12	GR GR	3 3	16 1/4 16 1/4	1/4 1/4		A A	N	122381
16 1/2	17 1/16	2	INTERNATIONAL		VT	C	3	12	GR GR	2 1/4 2 1/4	17 1/2 17 1/2	C C		A A	N	122646
17	22	1 1/4	INTERNATIONAL		VT	C	2	12	GR GR	2 1/4 2 1/4	21 7/8 21 7/8	C C		A A	N	128522
17 1/2	17 1/16	2	INTERNATIONAL		VT	C	3	12	GR GR	2 3/4 2 3/4	16 5/8 16 5/8	C C		A A	N	122586
17 1/2	28 1/16	1 1/4	INTERNATIONAL		VT	C	2	12	GR GR	2 1/2 2 1/2	28 1/8 28 1/8	1/4 1/4		A A	N	124600
17 1/2	28 1/16	1 1/4	INTERNATIONAL		VT	C	2	12	GR GR	2 1/2 2 1/2	28 1/8 28 1/8	C C		A A	N	124599
17 1/2	28 1/16	2	INTERNATIONAL		VT	C	3	12	GR GR	2 1/2 2 1/2	28 1/8 28 1/8	1/4 1/4		A A	N	124888
17 5/8	17 1/16	1 1/4	INTERNATIONAL		VT	C	2	14	GR GR	2 3/4 2 3/4	16 3/4 16 3/4	1/4 1/4		A A	N	122473
17 5/8	17 1/16	1 1/4	INTERNATIONAL		VT	C	2	12	GR GR	2 7/8 2 7/8	16 3/4 17	1/4 1/4		A A	N	124598
17 5/8	17 1/16	2	INTERNATIONAL		VT	C	3	12	GR GR	2 7/8 2 7/8	16 3/4 16 3/4	C C		A A	N	128815
17 5/8	21 15/16	2 1/4	INTERNATIONAL		T	C	3	8	GR GR	3 1/2 2 1/2	22 3/8 22 3/8	1/4 1/4		A A	N	260860
17 5/8	24 3/16	1 1/4	INTERNATIONAL		VT	C	2	12	GR GR	2 13/16 1 3/4	24 5/8 24	5/16 C		A A	N	124601
17 5/8	24 3/16	2	INTERNATIONAL		VT	C	3	12	GR GR	2 3/4 2 1/4	24 3/4 24	C C		A A	N	124656
17 7/8	22 1/2	2 1/4	INTERNATIONAL		T	C	3	8	GR GR	3 1/2 2 1/2	22 3/8 22 3/8	1/8 1/8		A A	N	270860
17 7/8	22 1/2	3	INTERNATIONAL		T	C	4	9	GR GR	3 1/4 3 1/4	22 7/16 22 7/16	C C		A A	N	270298
18	19 11/16	2 1/4	INTERNATIONAL		T	C	3	9	GR GR	3 1/4 2 3/8	19 3/4 19 3/4	1/8 C		A A	N	271945

Vista-Pro Automotive - Core Catalog

(Cores Sorted by Application)

Height	Width	Depth	Application	Description	Fln Type	Fln Matl	Rows	FPI	BH/TH Type	BH/TH Width	BH/TH Length	BH/TH OHF	BH/TH Bolts	BH/TH Shape	Hdr Support	Part #
INTERNATIONAL (Cont)																
18	19 11/16	3	INTERNATIONAL		T	C	4	8	GR GR	3 1/8 3 1/8	19 7/8 19 7/8	C C		A A	N	261956
18	22 1/2	2 1/4	INTERNATIONAL		T	C	3	6	GR GR	3 1/4 2 1/4	22 1/2 22 1/2	1/4 C		A A	N	260381
21 5/8	22	1 1/4	INTERNATIONAL		VT	C	2	12	GR GR	2 3/4 2 3/4	22 22	1/4 1/4		A A	N	124657
21 5/8	22	2	INTERNATIONAL		VT	C	3	12	GR GR	2 3/4 2 3/4	22 22	C C		A A	N	124764
22	19 1/4	1 1/4	INTERNATIONAL		VT	C	2	12	GR GR	2 1/2 2 1/2	19 3/8 19 3/8	C C		A A	N	124655
22 3/16	19 1/4	2	INTERNATIONAL		VT	C	3	12	GR GR	2 1/2 2 1/2	19 3/8 19 3/8	C C		A A	N	124597
23 5/8	14 7/8	1 1/4	INTERNATIONAL		VT	C	2	14	GR GR	2 3/8 2 3/8	16 1/2 16 1/2	C C		A A	N	124989
24 1/4	25 5/16	2 5/8	INTERNATIONAL	BUS	VT	C	4	12	GR GR	3 1/2 3 1/2	25 3/4 25 3/4	C C		A A	N	128143
24 1/4	26 3/8	2 5/8	INTERNATIONAL		VT	C	4	13	GR GR	4 4	26 3/4 26 3/4	3/16 3/16		A A	N	122674
24 1/2	22	2 5/8	INTERNATIONAL		VT	C	4	12	GR GR	2 3/4 2 3/4	22 1/16 22 1/16	C C		A A	N	128530
24 5/8	22	1 1/4	INTERNATIONAL		VT	C	2	12	GR GR	2 3/4 2 3/4	22 22	1 1/4 1 1/4		A A	N	124664
24 5/8	22	2	INTERNATIONAL		VT	C	3	12	GR GR	2 11/16 2 11/16	22 1/4 22 1/4	3/16 3/16		A A	N	122694
24 5/8	22	2	INTERNATIONAL		VT	C	3	12	GR GR	2 3/4 2 3/4	22 22	C C		A A	N	124549
24 3/4	23 5/8	2 5/8	INTERNATIONAL		VT	C	4	12	GR GR	3 1/8 3 1/8	24 24	C C		A A	N	122335
24 7/8	22	2	INTERNATIONAL		VT	C	3	12	GR GR	2 1/4 2 1/4	21 9/16 21 9/16	C C		A A	N	124661
25	22	2	INTERNATIONAL		VT	C	3	12	GR GR	2 1/2 2 1/2	21 11/16 21 11/16	C C		A A	N	128656
26 1/4	25 7/8	2 5/8	INTERNATIONAL		VT	C	4	14	GR GR	4 4	26 3/4 26 3/4	1/4 1/4		A A	N	128481
26 1/2	25 5/16	2 5/8	INTERNATIONAL		VT	C	4	12	GR GR	3 1/2 3 1/2	25 3/4 25 3/4	C C		A A	N	128524
26 1/2	25 7/8	2	INTERNATIONAL		VT	C	3	12	GR GR	3 1/8 3 1/8	26 26	5/8 5/8		A A	N	122222
26 1/2	25 7/8	2	INTERNATIONAL		VT	C	3	12	GR GR	2 1/4 2 1/4	25 3/4 25 3/4	3/16 3/16		A A	N	124404
26 1/2	25 7/8	2	INTERNATIONAL		VT	C	3	12	GR GR	2 1/2 2 1/2	26 3/8 26 3/8	1/4 1/4		A A	N	124928
26 1/2	26 3/8	1 1/4	INTERNATIONAL		VT	C	2	12	GR GR	2 1/2 2 1/2	26 3/8 26 3/8	3/16 3/16		A A	N	128103
26 5/8	25 5/16	2	INTERNATIONAL		VT	C	3	12	GR GR	2 3/8 2 3/8	25 3/4 25 3/4	C C		A A	N	124929
26 3/4	25 7/8	2 5/8	INTERNATIONAL		VT	C	4	12	GR GR	3 1/8 3 1/8	26 1/8 26 1/8	C C		A A	N	128679
28 1/2	25 7/8	2	INTERNATIONAL		VT	C	3	12	GR GR	3 3	26 1/4 26 1/4	9/16 9/16		A A	N	122657
28 1/2	25 7/8	2	INTERNATIONAL		VT	C	3	12	GR GR	3 3	26 26	C C		A A	N	124930
28 7/8	27 1/2	2	INTERNATIONAL		VT	C	3	12	GR GR	2 7/8 2 7/8	28 28	C C		A A	N	122650

Vista-Pro Automotive - Core Catalog

(Cores Sorted by Application)

Height	Width	Depth	Application	Description	Fin Type	Fin Matl	Rows	FPI	BH / TH Type	BH / TH Width	BH / TH Length	BH / TH OHF	BH / TH Bolts	BH / TH Shape	Hdr Support	Part #
INTERNATIONAL (Cont)																
29 3/4	25 13/16	2	INTERNATIONAL	6 x 6 CRANK BOX	VT	C	3	14	GR GR	2 7/8 2 7/8	26 3/8 26 3/8	C C		A A	N	128003
29 3/4	25 7/8	1 1/4	INTERNATIONAL		VT	C	2	14	GR GR	3 3	26 13/16 26 13/16	C C		A A	N	128713
29 3/4	25 7/8	2	INTERNATIONAL		VT	C	3	12	GR GR	3 1/16 3 1/16	26 26	C C		A A	N	122670
29 3/4	25 7/8	2	INTERNATIONAL		VT	C	3	14	GR GR	3 1/8 3 1/8	26 5/8 26 5/8	C C		A A	N	128854
29 3/4	25 7/8	2	INTERNATIONAL		VT	C	3	12	GR GR	3 1/8 3 1/8	26 1/4 26 1/4	C C		A A	N	124986
29 3/4	25 7/8	2 5/8	INTERNATIONAL		VT	C	4	12	GR GR	3 1/8 3 1/8	26 1/4 26 1/4	C C		A A	N	124984
31	12 5/8	2	INTERNATIONAL		VT	C	3	16	GR GR	3 1/8 3 1/8	26 5/8 26 5/8	C C		A A	N	128890
31	25 7/8	1 1/4	INTERNATIONAL		VT	C	2	14	GR GR	3 3	26 13/16 26 13/16	C C		A A	N	128712
31	25 7/8	2	INTERNATIONAL		VT	C	3	12	GR GR	2 7/8 2 7/8	26 1/4 26 1/4	C C		A A	N	124051
31	25 7/8	2	INTERNATIONAL		VT	C	3	16	GR GR	3 1/8 3 1/8	26 1/4 26 1/4	5/8 5/8		A A	N	128709
31	25 7/8	2	INTERNATIONAL		VT	C	3	12	GR GR	3 3	26 26	C C		A A	N	124970
31	26 3/8	2	INTERNATIONAL		VT	C	3	12	GR GR	3 1/8 3 1/8	26 5/8 26 5/8	3/8 3/8		A A	N	122672
31 1/16	11 7/8	2 3/8	INTERNATIONAL	CAC MOUNTS UNDER HDR 3/8" OFFSET SIDE	R	C	4	11	GR GR	3 3	26 26	C C		A A	C	226849
39 15/16	28 1/8	2 3/8	INTERNATIONAL	9370, 9670 CAN USE 284693	R	C	4	11	BL BL	6 6	30 3/4 30 3/4	1 1/2 1 1/2	40 40	A A	C	226893
INTERNATIONAL HARVESTER																
13 3/4	11 13/16	2 1/4	INT'L HARVESTER	FARMALL CUB 352903 R92	T	C	3	7	GR BL	3 1/4 4	12 14 1/4	C C		A A	N	223173
13 3/4	11 7/8	2 3/16	INT'L HARVESTER	FARMALL CUB	Z	C	3	9	GR BL	3 1/4 4	12 14 1/4	9/16 9/16	18	A A	N	225444
13 3/4	11 7/8	2 3/8	INT'L HARVESTER	FARMALL CUB 351878-R93	S	C	4	8	GR BL	3 1/4 4	12 14 1/4	C C	18	A A	N	229088
15	13 1/2	2 1/4	INT'L HARVESTER	CUB CADET JTL SERIES	T	C	3	6	GR GR	3 1/4 3 1/4	14 3/8 14 3/8	C C		A A	N	223175
15	13 3/4	2 3/16	INT'L HARVESTER	CUB CADET LAWNMOWER	Z	C	3	7	GR GR	3 1/4 3 1/4	14 3/8 14 3/8	C C		A A	N	225436
15	13 3/4	2 3/8	INT'L HARVESTER	CUB CADET JTL SERIES 404547-R3	S	C	4	7	GR GR	3 1/4 3 1/4	14 3/8 14 3/8	C C		A A	N	229089
15	16 1/4	3	INT'L HARVESTER	444 BKT T/HDR RD INL 4 1/2" RT	X	C	4	8	BU GR	5 7/8 3 3/8	17 16 5/8	7/16 7/16		A A	N	289375
15	16 5/16	3	INT'L HARVESTER	BKT T/HDR RD INL 4 1/2" RT	T	C	4	7	BU GR	5 7/8 3 5/16	17 16 1/2	1/4 C		A A	N	276742
15 3/4	15 5/8	2 1/4	INT'L HARVESTER		X	C	3	8	GR GR	3 3	16 1/4 16 1/4	C C		A A	N	281655
16 1/8	15 5/8	2 3/16	INT'L HARVESTER	140	Z	C	3	7	GR GR	6 3/8 3 1/16	16 1/4 16 1/4	1/2 1/2		A A	N	225449
16 1/8	15 5/8	2 1/4	INT'L HARVESTER	FARMALL SUPER C	X	C	3	8	GR GR	6 3	16 1/4 16 1/4	1/4 1/4		A A	N	288183
16 1/8	15 3/4	2 1/4	INT'L HARVESTER	140	T	C	3	9	GR GR	6 3/8 3 1/16	16 1/4 16 1/4	1/2 1/2		A A	N	223191

Vista-Pro Automotive - Core Catalog

(Cores Sorted by Application)

Height	Width	Depth	Application	Description	Fln Type	Fln Matl	Rows	FPI	BH/TH Type	BH/TH Width	BH/TH Length	BH/TH OHF	BH/TH Bolts	BH/TH Shape	Hdr Support	Part #
INTERNATIONAL HARVESTER (Cont)																
16 1/4	16 1/4	2 1/4	INT'L HARVESTER	B-275 DIESEL	X	C	3	7	GR GR	5 1/2 3 1/4	17 17	C C		A A	N	221275
16 1/4	16 1/4	2 1/4	INT'L HARVESTER	B-275 DIESEL	X	C	3	7	SQ SQ	5 1/2 3 1/4	17 17	1/4 1/4		A A	N	287530
16 1/4	16 1/4	2 3/8	INT'L HARVESTER	FARMALL 358103-R94	S	C	4	7	GR GR	6 3/8 3 1/16	16 1/4 16 1/4	1/8 1/8		A A	N	229090
16 1/4	16 1/4	2 15/16	INT'L HARVESTER	FARMALL C	Z	C	4	9	GR GR	6 3/8 3 1/16	16 1/4 16 1/4	3/16 C		A A	N	225450
16 1/4	16 5/16	2 1/4	INT'L HARVESTER	140	T	C	3	6	GR GR	6 3/8 3 1/8	16 1/4 16 1/4	1/8 1/8		A A	N	223176
16 1/4	16 5/16	3	INT'L HARVESTER	FARMALL C	T	C	4	7	GR GR	6 3/8 3 1/16	16 1/4 16 1/4	3/16 C		A A	N	223180
16 1/2	16 1/4	2 3/16	INT'L HARVESTER	B SERIES	Z	C	3	9	CR CR	6 5/8 2 7/8	17 17 1/4	5/16 5/16		A A	N	225452
16 1/2	16 5/16	2 1/4	INT'L HARVESTER	FARMALL B, SUPER A	T	C	3	7	CR CR	6 5/8 2 7/8	17 17 1/4	3/8 3/8		A A	N	223177
16 11/16	18 1/8	2 3/8	INT'L HARVESTER	539563-R2, 539562-R2	S	C	4	9	FR FR	2 1/2 2 1/2	18 11/16 18 11/16	C C		0 0	N	229091
16 3/4	17 7/16	3	INT'L HARVESTER	3414 DIESEL	T	C	4	6	GR GR	5 1/2 3 1/4	18 3/8 18 3/8	1/8 1/8		A A	N	279297
16 3/4	17 1/2	2 15/16	INT'L HARVESTER	BRITISH	Z	C	4	9	GR GR	5 1/2 3 1/4	18 1/4 18 1/2	1/4 1/4		A A	N	289176
17	17 7/16	3	INT'L HARVESTER		T	C	4	6	GR GR	5 3/8 3 3/4	18 3/8 18 1/4	1/8 1/8		A A	N	279298
17	17 1/2	3	INT'L HARVESTER		X	C	4	11	GR GR	5 3/8 3 3/4	18 3/8 18 1/4	3/16 3/16		A A	N	286597
17 1/2	16 1/4	3	INT'L HARVESTER	424 DIESEL	X	C	4	9	GR GR	6 1/4 3 1/4	16 1/4 16 1/4	1/4 C		A A	N	266242
17 1/2	16 1/4	3	INT'L HARVESTER	2424	X	C	4	11	GR GR	6 3/8 3 1/4	16 3/8 16 3/8	3/16 3/16		A A	N	289376
17 1/2	16 5/16	2 1/4	INT'L HARVESTER		T	C	3	10	GR GR	6 3 1/4	16 1/2 16 1/2	3/16 3/16		A A	N	279299
17 1/2	16 5/16	3	INT'L HARVESTER	424 DIESEL	T	C	4	7	GR GR	6 3/8 3 3/8	16 1/4 16 1/4	3/16 3/16		A A	N	276741
17 5/8	17 1/16	1 1/4	INT HARV TRK		VT	C	2	12	GR GR	2 13/16 2 13/16	16 3/4 16 3/4	1/4 1/4		A A	N	122649
18	16 1/4	2 3/16	INT'L HARVESTER	FARMALL H	Z	C	3	7	CR CR	7 1/4 4 1/4	17 3/4 17 3/4	3/8 3/8		A A	N	225526
18	16 1/4	2 3/16	INT'L HARVESTER	MODEL 340	Z	C	3	9	CR CR	7 1/4 4	17 3/4 15 3/4	3/8 7/8		A A	N	225541
18	16 1/4	3	INT'L HARVESTER	FARMALL H, SUPER H T/HDR RD REAR	X	C	4	7	CR CR	7 1/4 4 1/4	17 3/4 17 3/4	1/2 1/2		A A	N	221826
18	16 5/16	2 1/4	INT'L HARVESTER	340	T	C	3	6	CR CR	7 1/4 4 1/4	17 3/4 17 3/4	1/2 1/2		A A	N	223170
18	16 5/16	3	INT'L HARVESTER	FARMALL	T	C	4	7	CR CR	7 1/4 4 3/16	17 3/4 17 3/4	3/8 9/16		A A	N	270246
18 1/8	15 3/4	3	INT'L HARVESTER	300-350	T	C	4	6	GR GR	7 3 3/4	17 1/2 15 1/2	1/2 1/2		A A	N	261224
18 1/8	16 1/4	2 15/16	INT'L HARVESTER	FARMALL 300-350	Z	C	4	7	SQ GR	7 3 3/4	17 1/2 15 1/2	3/8 3/8		A A	N	287520
18 1/4	15 3/4	2 1/4	INT'L HARVESTER	340	T	C	3	8	GR GR	7 3/4 3 7/8	17 1/2 15 5/8	7/8 C		A A	N	275109
18 3/8	18	2 1/4	INT'L HARVESTER		T	C	3	8	GR GR	2 1/2 2 1/2	18 3/4 18 3/4	C C		A A	N	223200

Vista-Pro Automotive - Core Catalog

(Cores Sorted by Application)

Height	Width	Depth	Application	Description	Fin Type	Fin Matl	Rows	FPI	BH/TH Type	BH/TH Width	BH/TH Length	BH/TH OHF	BH/TH Bolts	BH/TH Shape	Hdr Support	Part #
INTERNATIONAL HARVESTER (Cont)																
18 3/8	18 1/8	2 3/16	INT'L HARVESTER		Z	C	3	9	GR	2 1/2	18 3/4	C		A	N	225458
									GR	2 1/2	18 3/4	C		A		
18 3/8	18 3/4	2 3/8	INT'L HARVESTER	539566-R2, 66495-C2, 539561-R2	S	C	4	8	GR	2 1/2	18 3/4	C		A	N	229013
									GR	2 1/2	18 3/4	C		A		
18 5/8	18 1/8	2 3/16	INT'L HARVESTER		Z	C	3	9	GR	2 1/2	18 3/4	C		A	N	289638
									GR	2 1/2	18 3/4	C		A		
19	15	2 3/16	INT'L HARVESTER	W12	Z	C	3	7	BL	5 5/8	17 1/2	1 1/4	23	F	C	281462
									BL	5 5/8	17 1/2	1 1/4	23	F		
19	15 3/16	2 1/4	INT'L HARVESTER	FARMALL	T	C	3	6	BL	5 5/8	17 1/2	1 5/8	23	A	C	223233
									BL	5 5/8	17 1/2	1 5/8	23	A		
20 1/8	15 3/4	3 3/4	INT'L HARVESTER	606 DIESEL	T	C	5	10	GR	7 1/4	17 1/2	3/8		A	N	264031
									GR	4 1/4	17 1/2	3/8		A		
20 1/8	16 1/4	3	INT'L HARVESTER	606 DIESEL	X	C	4	9	GR	7 1/8	17 5/8	3/8		A	N	275011
									GR	3 7/8	15 5/8	3/8		A		
20 1/8	21 1/4	3	INT'L HARVESTER	U-6, D-6	X	C	4	7	BL	5 1/2	24 3/8	1 1/16	23	F	C	280613
									BL	5 1/2	24 3/8	1 1/16	23	F		
20 1/4	16 1/4	2 15/16	INT'L HARVESTER	340, 460	Z	C	4	10	GR	7 1/8	17 3/8	1/2		A	N	225459
									GR	3 3/4	15 5/8	5/8		A		
20 1/4	16 5/16	3 3/4	INT'L HARVESTER	340 CRAWLER	T	C	5	7	GR	7 1/8	17 1/2	3/8		A	N	279307
									GR	3 7/8	17 3/8	3/8		A		
20 1/4	19 3/8	3 3/4	INT'L HARVESTER	3616 BACK HOE	X	C	5	7	GR	4 1/4	19 1/2	C		A	N	221786
									GR	4 1/4	19 1/2	C		A		
20 3/8	15 5/8	2 7/8	INT'L HARVESTER	340D 377090-R92	S	C	5	7	GR	7 1/8	17 3/8	3/8		A	N	229092
									GR	3 3/4	15 3/4	C		A		
20 3/8	15 3/4	3	INT'L HARVESTER	460	T	C	4	7	GR	7 1/8	17 3/8	3/8		SP	N	223199
									GR	3 3/4	15 3/4	5/8		A		
20 3/8	15 3/4	3 3/4	INT'L HARVESTER	405, 606	T	C	5	10	GR	7 1/8	17 3/8	1/4		A	N	263213
									GR	3 3/4	15 3/4	C		A		
20 3/8	19 3/8	2 7/8	INT'L HARVESTER	TX47 400941-R1, 65426-C1	S	C	5	7	GR	4 1/4	19 5/8	C		A	N	229093
									GR	4 1/4	19 5/8	C		A		
20 3/8	19 3/8	2 15/16	INT'L HARVESTER	F20 P20 T20	Z	C	4	7	BL	5 1/4	22	1 1/8	28	F	C	280493
									BL	5 1/4	22	1 1/8	28	F		
20 3/8	19 3/8	3 7/16	INT'L HARVESTER	656 396352-R91, 391200-R91	S	C	6	9	GR	4 1/4	19 5/8	C		A	N	229094
									GR	4 1/4	19 5/8	C		A		
20 3/8	19 11/16	3 3/4	INT'L HARVESTER	706D	T	C	5	7	GR	4 1/4	19 3/4	C		A	N	223178
									GR	4 1/4	19 3/4	C		A		
20 1/2	19 3/8	3 3/4	INT'L HARVESTER	FARMALL 706	X	C	5	7	GR	4 1/4	19 3/4	C		A	N	221814
									GR	4 1/4	19 3/4	C		A		
20 3/4	29 1/4	4 1/2	INT'L HARVESTER	4WD TRACTOR	T	C	6	9	GR	4 3/4	29 3/4	C		A	N	272689
									GR	4 3/4	29 3/4	C		A		
22 7/16	19 1/8	3	INT'L HARVESTER	FARMALL 460	T	C	4	7	GR	4 1/4	19 3/4	C		A	N	223234
									GR	4 1/4	19 3/4	C		A		
22 7/16	19 1/8	3 3/4	INT'L HARVESTER		T	C	5	8	GR	4 1/4	19 3/4	C		A	N	263953
									GR	4 1/4	19 3/4	C		A		
22 7/16	19 3/8	2 15/16	INT'L HARVESTER	460	Z	C	4	8	GR	4 1/4	19 3/4	C		A	N	288641
									GR	4 1/4	19 3/4	C		A		
22 7/16	19 11/16	3 3/4	INT'L HARVESTER	FARMALL F-560 DIESEL	T	C	5	7	GR	4 1/4	19 7/8	C		A	N	274790
									GR	4 1/4	19 7/8	C		A		
22 5/8	18 9/16	2 1/4	INT'L HARVESTER	FARMALL A	T	C	3	7	GR	7	19 5/8	1/2		A	N	223235
									GR	3 1/2	19 5/8	1/2		A		
22 5/8	18 9/16	2 1/4	INT'L HARVESTER	SUPER M CRP/HDRS	T	C	3	6	CR	8 1/2	19 3/4	1/2		A	N	223236
									CR	4 1/4	19 3/4	1/2		A		
22 5/8	18 9/16	2 1/4	INT'L HARVESTER	FARMALL M	T	C	3	7	GR	8 1/4	19 5/8	1/2		A	N	260251
									GR	3 3/4	19 3/8	1/2		A		

Vista-Pro Automotive - Core Catalog

(Cores Sorted by Application)

Height	Width	Depth	Application	Description	Fln Type	Fln Matl	Rows	FPI	BH/TH Type	BH/TH Width	BH/TH Length	BH/TH OHF	BH/TH Bolts	BH/TH Shape	Hdr Support	Part #
INTERNATIONAL HARVESTER (Cont)																
22 5/8	18 9/16	2 1/4	INT'L HARVESTER	FARMALL M	T	C	3	7	GR	8 1/4	19 5/8	9/16		A	N	270920
									GR	3 3/4	19 5/8	9/16		A	N	262163
22 5/8	18 9/16	3 3/4	INT'L HARVESTER	M DIESEL CRP/HDRS	T	C	5	7	CR	7 1/4	17 3/4	3/8		A	N	262163
									CR	4 1/4	19 3/4	1/2		A	N	288223
22 5/8	18 3/4	2 1/4	INT'L HARVESTER	FARMALL M	X	C	3	6	CR	8 1/4	19 5/8	1/2		A	N	288223
									CR	3 3/4	19 5/8	1/2		A	N	265901
22 5/8	18 3/4	3	INT'L HARVESTER	SUPER M	X	C	4	7	CR	8 1/4	19 5/8	3/8		A	N	265901
									CR	3 3/4	19 5/8	3/8		A	N	265902
22 5/8	18 3/4	3	INT'L HARVESTER	M CRP/HDRS	X	C	4	6	CR	8 1/2	17 3/4	1/2		A	N	265902
									CR	4 1/4	19 3/4	1/2		A	N	274783
22 5/8	18 3/4	3	INT'L HARVESTER	FARMALL M CRP HDRS	X	C	4	7	CR	8 1/2	19 3/4	9/16		A	N	274783
									CR	4 1/4	19 3/4	9/16		A	N	229029
22 5/8	18 3/4	3 7/16	INT'L HARVESTER	FARMALL CRP/HDRS	S	C	6	10	CR	8 1/2	19 3/4	1/2		A	N	229029
									CR	4 1/4	19 3/4	1/2		A	N	229096
22 11/16	25	2 3/8	INT'L HARVESTER	UB220 265595-R93	S	C	4	6	GR	5 1/4	25 5/8	9/16		A	N	229096
									GR	4	25 5/8	1/2		A	N	229097
22 11/16	25	2 7/8	INT'L HARVESTER	UD236 304608-R93	S	C	5	8	GR	5 1/4	25 5/8	9/16		A	N	229097
									GR	4	25 5/8	C		A	N	229098
22 11/16	25	3 7/16	INT'L HARVESTER	UD282 610643-C91	S	C	6	9	GR	5 1/4	25 5/8	9/16		A	N	229098
									GR	4	25 5/8	C		A	N	223237
22 11/16	25 5/16	3	INT'L HARVESTER	UD236 304608-R93	T	C	4	8	GR	5 1/4	25 5/8	3/8		A	N	223237
									GR	4	25 5/8	3/8		A	N	221810
23	19 3/8	3 3/4	INT'L HARVESTER	1806	X	C	5	7	GR	4 3/8	19 3/4	C		A	N	221810
									GR	4 3/8	19 3/4	C		A	N	287721
23 1/4	18 3/4	3 11/16	INT'L HARVESTER	220A COTTON PICKER	Z	C	5	8	GR	4 1/2	19 1/2	C		A	N	287721
									GR	4 1/2	19 1/2	C		A	N	229100
23 1/4	19 3/8	3 7/16	INT'L HARVESTER	806 DIESEL 391931-R1, 386860-R1	S	C	6	9	GR	4 1/2	19 1/2	C		A	N	229100
									GR	4 1/2	19 1/2	C		A	N	221800
23 1/4	19 3/8	3 3/4	INT'L HARVESTER	1256 TRACTOR	X	C	5	8	GR	4 1/4	19 7/8	C		A	N	221800
									GR	4 1/4	19 7/8	C		A	N	280908
23 3/8	20	2 15/16	INT'L HARVESTER	103,15-30,16-35	Z	C	4	7	BL	6 1/8	24	1 1/4	28	F	C	280908
									BL	6 1/8	24	1 1/4	28	F	C	280494
23 1/2	20 5/8	2 15/16	INT'L HARVESTER	15-30	Z	C	4	7	BL	5 1/2	24	1 1/4	32	F	C	280494
									BL	5 1/2	24	1 1/4	32	F	C	279315
23 3/4	21	4 1/2	INT'L HARVESTER	C-100 FRONT END LOADER BRASS FINS FACE DIPPED	B	B	6	7		5 7/8	21 7/8	1/8		0	N	279315
										5 7/8	21 7/8	5/8		0	N	285097
24	20 5/8	4 7/16	INT'L HARVESTER	C-100 FRONT END LOADER BRASS FINS	Z	B	6	9	GR	5 7/8	21 7/8	3/16		A	C	285097
									GR	5 7/8	21 7/8	3/16		A	C	265755
24	20 13/16	4 1/2	INT'L HARVESTER	C-100 FRONT END LOADER	T	C	6	9	GR	5 7/8	21 7/8	1/4		A	C	265755
									GR	5 7/8	21 7/8	5/8		A	C	272691
24	21	4 1/2	INT'L HARVESTER	BRASS FINS FACE DIPPED	B	B	6	7	GR	5 7/8	21 7/8	1/8		A	C	272691
									GR	5 7/8	21 7/8	1/8		A	C	229101
24	22 1/2	2 3/8	INT'L HARVESTER	966, 104594-C2, 121723-C1	S	C	4	8	GR	4 1/4	22 7/8	C		A	C	229101
									GR	4 1/4	22 7/8	C		A	C	229102
24	22 1/2	2 7/8	INT'L HARVESTER	1066, 121724-C2, 71610-C1	S	C	5	9	GR	4 1/4	22 7/8	C		A	C	229102
									GR	4 1/4	22 7/8	C		A	C	221811
24	22 1/2	3	INT'L HARVESTER	966, 1066	X	C	4	8	GR	4 1/4	22 7/8	C		A	C	221811
									GR	4 1/4	22 7/8	C		A	C	223181
24	22 1/2	3	INT'L HARVESTER	966, 1066	T	C	4	7	GR	4 1/4	22 7/8	C		A	C	223181
									GR	4 1/4	22 7/8	C		A	C	229014
24	22 1/2	3 7/16	INT'L HARVESTER	966, 1066	S	C	6	9	GR	4 1/4	22 7/8	C		A	C	229014
									GR	4 1/4	22 7/8	C		A	C	225460
24	22 1/2	3 11/16	INT'L HARVESTER	1066	Z	C	5	10	GR	4 1/4	22 7/8	C		A	C	225460
									GR	4 1/4	22 7/8	C		A	C	

Vista-Pro Automotive - Core Catalog

(Cores Sorted by Application)

Height	Width	Depth	Application	Description	Fin Type	Fin Matl	Rows	FPI	BH/TH Type	BH/TH Width	BH/TH Length	BH/TH OHF	BH/TH Bolts	BH/TH Shape	Hdr Support	Part #
INTERNATIONAL HARVESTER (Cont)																
24	22 1/2	3 3/4	INT'L HARVESTER	966, 1066	X	C	5	7	GR	4 1/4	22 7/8	C		A	C	221505
									GR	4 1/4	22 7/8	C		A		
24	22 1/2	3 3/4	INT'L HARVESTER	533587 R2	X	C	5	9	GR	4 1/4	22 7/8	C		A	C	221812
									GR	4 1/4	22 7/8	C		A		
24	22 1/2	3 3/4	INT'L HARVESTER		T	C	5	8	GR	4 1/4	22 7/8	C		A	C	223184
									GR	4 1/4	22 7/8	C		A		
24	22 1/2	3 15/16	INT'L HARVESTER	1486, 1586 71611-C1	S	C	7	9	GR	4 1/4	22 7/8	C		A	C	229015
									GR	4 1/4	22 7/8	C		A		
25 1/8	19 3/8	3 3/4	INT'L HARVESTER	DIESEL 660 WHEATLAND	X	C	5	7	GR	4 1/4	19 3/4	C		A	C	288192
									GR	4 1/4	19 3/4	C		A		
27 1/8	25	3 7/16	INT'L HARVESTER	3388 121845-C3	S	C	6	9	GR	4 1/4	25 3/4	C		A	C	229103
									GR	4 1/4	25 3/4	C		A		
27 1/8	25	3 15/16	INT'L HARVESTER	3788 130814-C3	S	C	7	9	GR	4 1/4	25 3/4	C		A	C	229104
									GR	4 1/4	25 3/4	C		A		
27 13/16	20 1/2	4 1/2	INT'L HARVESTER	125 LOADER HVY T/BTM HDRS BRASS FINS FACE DIPPED 15/16" BTWN HOLES 1 & 2	B	B	6	7	BH	8	22 3/8	1 3/8	34	A	C	272694
									BH	7 3/8	22 3/8	1 3/8	34	A		
27 13/16	20 1/2	4 1/2	INT'L HARVESTER	125 LOADER HVY T/BTM HDRS BRASS FINS FACE DIPPED 1 3/8" BTWN HOLES 1 & 2	B	B	6	7	BH	8	22 1/4	1 3/8	34	A	C	272695
									BH	7 3/8	22 1/4	1 3/8	34	A		
27 13/16	25	2 7/8	INT'L HARVESTER	59954-C2	S	C	5	7	GR	5 7/8	25 7/8	C		A	C	229116
									GR	5 7/8	25 7/8	C		A		
27 15/16	25	2 15/16	INT'L HARVESTER	COTTON PICKER 401188-R3	Z	C	4	7	GR	5 7/8	25 7/8	C		A	C	225519
									GR	5 7/8	25 7/8	C		A		
27 15/16	25	3 7/16	INT'L HARVESTER	400734-R3	S	C	6	7	GR	5 7/8	25 7/8	C		A	C	229105
									GR	5 7/8	25 7/8	C		A		
27 15/16	25 5/8	2 7/8	INT'L HARVESTER	COTTON PICKER 782	S	C	5	6	GR	5 7/8	25 7/8	C		A	C	266250
									GR	5 7/8	25 7/8	C		A		
28 3/16	25	3 3/4	INT'L HARVESTER	COMBINE	B	C	5	6	GR	5 7/8	25 7/8	C		A	C	277396
									GR	5 7/8	25 7/8	C		A		
28 3/4	25 5/8	2 1/4	INT'L HARVESTER	U 372	X	C	3	8	GR	5 1/4	25 5/8	1 3/8		A	C	289273
									GR	4	25 5/8	1 3/8		A		
29 1/2	28	4 1/2	INT'L HARVESTER	530 LOADER BRASS FINS FACE DIPPED	B	B	6	7	GR	5 3/4	28 3/4	C		A	C	272696
									GR	5 3/4	28 3/4	C		A		
29 1/2	28 3/4	4 7/16	INT'L HARVESTER	530 LOADER BRASS FINS	Z	B	6	9	GR	5 3/4	28 5/8	C		A	C	285112
									GR	5 3/4	28 5/8	C		A		
30 1/2	26 1/4	2 3/8	INT'L HARVESTER	5088 146571-C2	S	C	4	9	GR	4 1/4	26 5/8	11/16		A	C	229107
									GR	4 1/4	26 5/8	11/16		A		
30 1/2	26 1/4	2 7/8	INT'L HARVESTER	5288, 146573-C1	S	C	5	9	GR	4 1/4	26 5/8	1/8		A	C	229108
									GR	4 1/4	26 5/8	1/8		A		
30 1/2	26 1/4	3 7/16	INT'L HARVESTER	5488 146572-C2	S	C	6	10	GR	4 1/4	26 5/8	11/16		A	C	229109
									GR	4 1/4	26 5/8	11/16		A		
30 1/2	26 1/4	3 15/16	INT'L HARVESTER	5488 146508-C1	S	C	7	10	GR	4 1/4	26 5/8	C		A	C	229110
									GR	4 1/4	26 5/8	C		A		
30 1/2	26 1/4	3 15/16	INT'L HARVESTER	5488 146508-C1	S	C	7	10	GR	4 1/4	26 5/8	C		A	C	229110
									GR	4 1/4	26 5/8	C		A		
30 1/2	26 1/4	3 15/16	INT'L HARVESTER	5488 146508-C1	S	C	7	10	GR	4 1/4	26 5/8	C		A	C	229110
									GR	4 1/4	26 5/8	C		A		
32 3/4	25	4 7/16	INT'L HARVESTER	1460, 1480 121722-C3, 130869-C2, 146529-C2	S	C	8	7	GR	5 7/8	25 3/4	3/4		A	C	229111
									GR	5 7/8	25 3/4	3/4		A		
32 3/4	25 5/16	4 1/2	INT'L HARVESTER	1486 COMBINE	T	C	6	7	GR	5 7/8	25 3/4	3/4		A	C	223182
									GR	5 7/8	25 3/4	3/4		A		

Vista-Pro Automotive - Core Catalog

(Cores Sorted by Application)

Height	Width	Depth	Application	Description	Fin Type	Fin Matl	Rows	FPI	BH / TH Type	BH / TH Width	BH / TH Length	BH / TH OHF	BH / TH Bolts	BH / TH Shape	Hdr Support	Part #
ISUZU																
15 1/4	21 7/16	1 1/4	ISUZU		VT	C	2	16	GR GR	1 7/8 1 7/8	21 7/8 21 7/8	C C		A A	N	128204
15 1/2	20 7/8	1 1/4	ISUZU		VT	C	2	16	GR GR	2 2	21 21	C C		A A	N	122440
16 3/8	23 1/8	2	ISUZU		VT	C	3	12	BU GR	4 1/4 2 1/4	25 3/4 23 5/8	1 7/8 C		A A	N	122341
16 1/2	22	1 1/4	ISUZU		VT	C	2	12	GR GR	1 7/8 1 7/8	21 7/8 21 7/8	C C		A A	N	128705
IVECO TRUCK																
19 1/2	17 1/2	2 3/8	IVECO TRUCK	220 Z	R	C	4	11	GR GR	2 3/4 2 3/4	18 18	C C		A A	N	226525
JAGUAR																
15 1/4	21 7/16	2	JAGUAR		VT	C	3	16	GR GR	3 3	21 3/4 21 3/4	C C		A A	N	128371
15 1/4	21 1/2	2 1/4	JAGUAR		VE	C	4	14	GR GR	3 3	21 3/4 21 3/4	C C		A A	N	122680
15 1/4	27 1/2	2 5/8	JAGUAR		VT	C	4	12	GR GR	3 1/16 3 1/16	27 3/4 27 3/4	C C		A A	N	124629
15 1/2	21 7/16	2 5/8	JAGUAR		VT	C	4	12	GR GR	3 1/4 3 1/4	21 3/4 21 3/4	C C		A A	N	128513
17	17 1/16	2 5/8	JAGUAR		VT	C	4	12	GR GR	3 1/4 3 1/4	17 17	C C		0 0	N	128361
17 1/4	17 5/8	2 5/8	JAGUAR		VT	C	4	12	GR GR	3 3	17 1/4 17 1/4	C C		A A	N	124182
17 1/4	19 1/8	3	JAGUAR		T	C	4	11		3 3	19 1/2 19 1/2	C C		0 0	N	263616
17 1/4	19 13/16	2 5/8	JAGUAR		VT	C	4	16	GR GR	3 1/8 3 1/8	19 3/8 19 3/8	C C		A A	N	128363
17 1/4	19 13/16	2 5/8	JAGUAR		VT	C	4	12	GR GR	3 3	19 1/2 19 1/2	C C		A A	N	128362
17 3/8	17 1/16	2 5/8	JAGUAR		VT	C	4	14	BX BX	2 5/8 2 5/8	16 7/8 16 7/8	C C		A A	N	128822
25 5/8	18 1/8	2 5/8	JAGUAR		VT	C	4	12	GR GR	3 1/4 3 1/4	18 1/4 18 1/4	C C		A A	N	128121
25 3/4	18 1/8	2	JAGUAR		VT	C	3	12	GR GR	3 1/8 3 1/8	18 18	C C		A A	N	124615
26	15 15/16	2 5/8	JAGUAR		VT	C	4	12	GR GR	3 1/16 3 1/16	16 16	C C		A A	N	128360
27 1/8	17 5/8	1 1/4	JAGUAR		VT	C	2	16	GR GR	1 3/4 1 3/4	17 5/8 17 5/8	C C		A A	N	124994
27 3/8	18 1/8	2 5/8	JAGUAR		VT	C	4	12	GR GR	3 3/16 3 3/16	18 3/16 18 3/16	C C		A A	N	124852
27 1/2	17 3/4	1 9/16	JAGUAR		VE	C	3	16	GR GR	2 2	17 3/4 17 3/4	C C		A A	N	122355
JEEP																
13 1/4	20	1 7/8	JEEP		X	C	2	8	GR GR	3 3/4 2 3/8	20 20	FF C		A A	N	263563
13 1/4	20	1 7/8	JEEP		X	C	2	10	GR FR	3 3/4 2	20 20	FF C		A A	N	264052
13 1/4	20	3	JEEP		X	C	4	9	GR GR	3 3/4 3	20 20	FF C		A A	N	262751
13 1/4	20 1/4	3	JEEP		T	C	4	8	GR GR	4 3	20 1/4 20 1/4	C C		A A	N	261386
13 1/2	19 13/16	1 1/4	JEEP		VT	C	2	12	GR GR	3 1/8 2 3/8	20 20	C C		A A	N	122353

Vista-Pro Automotive - Core Catalog

(Cores Sorted by Application)

Height	Width	Depth	Application	Description	Fin Type	Fin Matl	Rows	FPI	BH/TH Type	BH/TH Width	BH/TH Length	BH/TH OHF	BH/TH Bolts	BH/TH Shape	Hdr Support	Part #
JEEP (Cont)																
14 1/4	18 11/16	1 1/4	JEEP		VT	C	2	12	BU GR	4 1 3/4	19 1/4 18 1/2	C C		A A	N	122544
14 1/2	15 3/4	2 1/4	JEEP		T	C	3	10	GR GR	2 1/2 2 1/2	15 7/8 15 7/8	C C		A A	N	261204
15 1/8	17 1/16	1 1/4	JEEP		VT	C	2	12	BU GR	3 3/16 1 11/16	17 3/8 16 3/4	C C		A A	N	124975
15 3/16	17 5/8	1 1/4	JEEP		VT	C	2	14	BU GR	3 3/16 1 11/16	17 7/16 16 3/4	C C		A A	N	122265
15 3/16	17 5/8	1 1/4	JEEP		VT	C	2	12	BU GR	3 1/8 1 5/8	17 3/8 16 3/4	C C		A A	N	128596
15 3/4	17 1/16	2	JEEP		VT	C	3	14	GR GR	2 3/4 2 3/4	16 5/8 16 5/8	C C		A A	N	128448
15 3/4	25 7/8	2	JEEP		VT	C	3	14		3 2 1/16	25 5/8 25 5/8	C C		0 0	N	128405
15 7/8	25 7/8	2 5/8	JEEP		VT	C	4	12	GR GR	3 3	25 9/16 25 9/16	C C		A A	N	128634
16	24 3/16	2	JEEP		VT	C	3	12	GR GR	2 3/4 2 3/4	24 1/4 24 1/4	C C		A A	N	128457
16	26 3/8	2	JEEP		VT	C	3	12	GR GR	3 3	26 3/4 26 3/4	C C		A A	N	124835
16 1/8	19 13/16	2	JEEP		VT	C	3	12	GR GR	3 2 3/8	19 3/4 19 11/16	C C		A A	N	128358
16 1/4	19 1/8	2 1/4	JEEP		T	C	3	10	GR GR	3 2 1/2	19 1/4 19 1/4	C C		A A	N	263566
16 1/4	25 7/8	2 5/8	JEEP		VT	C	4	12	GR GR	3 3	25 9/16 25 9/16	C C		A A	N	128509
16 5/16	16 5/16	3	JEEP		T	C	4	10	GR GR	3 3/8 3 3/8	16 1/2 16 1/2	C C		A A	N	263182
16 3/8	17 1/16	2	JEEP		VT	C	3	12	GR GR	2 3/8 2 3/8	17 1/2 17 1/2	C C		A A	N	124806
16 3/8	19 1/4	2	JEEP		VT	C	3	14	GR GR	3 2 1/2	19 1/4 19 1/4	C C		A A	N	128344
16 1/2	16 7/8	2 1/4	JEEP		T	C	3	11		2 3/8 2 3/8	17 1/2 17 1/2	C C		0 0	N	260531
16 1/2	17 5/8	2	JEEP		VT	C	3	12	GR GR	2 3/8 2 3/8	17 1/2 17 1/2	C C		A A	N	122595
16 1/2	22	1 1/4	JEEP		VT	C	2	14	GR GR	2 1/2 1 13/16	21 1/2 21 1/2	C C		A A	N	128345
16 5/8	22	2	JEEP		VT	C	3	12		2 1/4 2 1/16	21 1/2 21 1/2	C C		0 0	N	128346
16 5/8	22	2	JEEP		VT	C	3	12	GR GR	2 1/2 2 1/4	21 1/2 21 1/2	C C		A A	N	128347
16 5/8	22	2	JEEP		VT	C	3	12	GR GR	2 1/2 2 1/2	21 5/8 21 5/8	C C		A A	N	128348
16 3/4	20 3/8	1 1/4	JEEP		VT	C	2	16	GR GR	2 3/8 2 3/8	20 20	C C		A A	N	128597
17	21 7/16	2	JEEP		VT	C	3	12		2 1/16 2 1/16	21 1/2 21 1/2	C C		0 0	N	128508
18	19 13/16	2	JEEP		VT	C	3	15	GR GR	2 1/4 2 1/4	20 20	C C		A A	N	128843
18 1/8	19 13/16	1 1/4	JEEP		VT	C	2	16	GR GR	2 1/4 2 1/4	20 20	C C		A A	N	128909
31	11 1/8	1 9/16	JEEP		VE	C	3	14	GR GR	2 3/8 2 3/8	11 5/16 11 5/16	C C		A A	N	128727

Vista-Pro Automotive - Core Catalog

(Cores Sorted by Application)

Height	Width	Depth	Application	Description	Fin Type	Fin Matl	Rows	FPI	BH/TH Type	BH/TH Width	BH/TH Length	BH/TH OHF	BH/TH Bolts	BH/TH Shape	Hdr Support	Part #
JOHN DEERE																
15	15	2 3/16	JOHN DEERE		Z	C	3	7	GR	6	15 5/8	3/16		A	N	281858
									GR	2 3/8	15 5/8	3/16		A		
15	15 3/16	2 1/4	JOHN DEERE		T	C	3	7	GR	6	15 5/8	1/8		A	N	223604
									GR	2 3/8	15 5/8	1/8		A		
15 1/2	14 3/8	2 1/4	JOHN DEERE	1010 DIESEL	X	C	3	8	GR	3 1/2	15 3/4	3/16		A	N	288562
									GR	3 1/2	15 3/4	3/16		A		
15 1/2	14 3/8	2 7/8	JOHN DEERE	1010 DIESEL AT13096	S	C	5	8	GR	3 7/16	15 3/4	C		A	N	229001
									GR	3 7/16	15 3/4	C		A		
15 1/2	14 3/8	3	JOHN DEERE	1010 DIESEL	X	C	4	8	GR	3 7/16	15 3/4	C		A	N	287948
									GR	3 7/16	15 3/4	C		A		
15 1/2	14 5/8	2 1/4	JOHN DEERE	1010 DIESEL	T	C	3	8	GR	3 7/16	15 3/4	1/8		A	N	278917
									GR	3 7/16	15 3/4	1/8		A		
15 3/4	14 5/8	2 1/4	JOHN DEERE		T	C	3	7	BL	5 3/4	15 3/4	C	16	A	C	270162
									BL	5 3/4	15 3/4	C	16	A		
16 1/2	14 1/16	2 1/4	JOHN DEERE		T	C	3	6	BL	5 3/4	16 3/4	1 3/8	20	A	C	223262
									BL	5 3/4	16 3/4	1 3/8	20	A		
16 1/2	14 3/8	2 15/16	JOHN DEERE	B	Z	C	4	7	BL	5 3/4	16 3/4	1 3/8	20	F	C	281563
									BL	5 3/4	16 3/4	1 3/8	20	F		
16 7/8	16 7/8	2 3/16	JOHN DEERE	COMBINE	Z	C	3	7	GR	3 1/2	17 3/4	3/16		A	N	281807
									GR	3 1/2	17 3/4	3/16		A		
17	13 1/2	3	JOHN DEERE	300 BACKHOE	T	C	4	8	GR	3 1/4	14	C		A	N	223185
									GR	3 1/4	14	C		A		
17	13 3/4	2 1/4	JOHN DEERE	300	X	C	3	7	GR	3 1/4	14	C		A	N	221240
									GR	3 1/4	14	C		A		
17	13 3/4	2 15/16	JOHN DEERE	300 BACKHOE	Z	C	4	9	GR	3 1/4	14	C		A	N	225507
									GR	3 1/4	14	C		A		
17	14 3/8	1 3/4	JOHN DEERE	AT10299	S	C	3	9	GR	6	15 3/4	1/8		A	N	229016
									GR	2 3/8	15 3/4	1/8		A		
17	14 3/8	2 1/4	JOHN DEERE	M, MC, MT 40	X	C	3	8	GR	6	15 3/4	1/4		A	N	266443
									FR	2 3/8	15 3/4	1/4		A		
17	14 5/8	2 1/4	JOHN DEERE	420	T	C	3	7	GR	6	15 3/4	1/4		A	N	223192
									FR	2 5/16	15 3/4	C		A		
17	15	2 1/4	JOHN DEERE		X	C	3	9	GR	6	15 3/4	3/16		A	N	287685
									GR	2 3/8	15 3/4	C		A		
17	15 3/16	2 1/4	JOHN DEERE		T	C	3	7	GR	6	15 3/4	1/8		A	N	223250
									GR	2 1/2	15 3/4	1/8		A		
17 1/8	13 1/2	2 1/4	JOHN DEERE		T	C	3	6	GR	3	13 3/4	C		A	N	278918
									GR	3	13 3/4	C		A		
17 1/8	13 3/4	2 7/8	JOHN DEERE	1530	S	C	5	8	GR	3 3/16	14	1/4		A	N	266210
									GR	3 3/16	14	1/4		A		
17 1/8	13 3/4	3	JOHN DEERE	CORE OFFSET FLUSH ONE END	X	C	4	10		3 1/8	14	C		0	N	266141
										3 1/8	14	C		0		
17 1/4	13 3/4	2 5/8	JOHN DEERE		VT	C	4	12	GR	3	13 3/4	C		A	N	124659
									GR	3	13 3/4	C		A		
17 1/4	18	2 1/4	JOHN DEERE	2010 DIESEL	T	C	3	7	GR	3 1/4	18 3/8	C		A	N	223193
									GR	3 1/4	18 3/8	C		A		
17 1/4	18	2 1/4	JOHN DEERE	1020	T	C	3	8	GR	3 1/4	18 3/8	C		A	N	264355
									GR	3 1/4	18 3/8	C		A		
17 1/4	18 1/8	2 3/16	JOHN DEERE	1020	Z	C	3	9	GR	3 1/4	18 3/8	C		A	N	225461
									GR	3 1/4	18 3/8	C		A		
17 1/4	18 1/8	2	JOHN DEERE		VT	C	3	12	GR	3 1/4	18 3/8	C		A	N	124883
									GR	3 1/4	18 3/8	C		A		
17 3/8	15 3/8	2 5/8	JOHN DEERE		VT	C	4	12	GR	3 1/8	15 3/16	C		A	N	122714
									GR	3 1/8	15 3/16	C		A		

Vista-Pro Automotive - Core Catalog

(Cores Sorted by Application)

Height	Width	Depth	Application	Description	Fin Type	Fin Matl	Rows	FPI	BH/TH Type	BH/TH Width	BH/TH Length	BH/TH OHF	BH/TH Bolts	BH/TH Shape	Hdr Support	Part #
JOHN DEERE (Cont)																
17 1/2	18 1/8	2 15/16	JOHN DEERE	10-20, 12-20	Z	C	4	9	BL BL	5 3/4 5 3/4	20 1/2 20 1/2	1 1/4 1 1/4	22 22	B B	C	281445
17 1/2	18 3/4	2 1/4	JOHN DEERE		X	C	3	7	BL BL	5 3/4 5 3/4	20 1/2 20 1/2	1 1/2 1 1/2	22 22	B B	C	260111
17 11/16	23 3/4	2 3/8	JOHN DEERE	210C BACKHOE AT118639	S	C	4	7	GR GR	4 1/2 4 1/2	23 15/16 23 15/16	C C		A A	N	229027
17 3/4	14 3/8	2 1/4	JOHN DEERE		X	C	3	8	BL BL	5 9/16 5 9/16	16 16	1 3/8 1 3/8	18 18	A A	C	280081
17 3/4	14 3/8	2 3/8	JOHN DEERE	B50 AB466R	S	C	4	7	BL BL	5 9/16 5 9/16	16 16	C C	18 18	A A	C	229006
17 3/4	14 3/8	2 15/16	JOHN DEERE	B50	Z	C	4	9	BL BL	5 9/16 5 9/16	16 16	1 3/8 1 3/8	18 18	A A	C	225463
17 3/4	14 3/8	3 7/16	JOHN DEERE	B50 AB3599	S	C	6	6	BL BL	5 9/16 5 9/16	16 16	1 1	18 18	A A	C	229036
18 1/2	15 5/8	2 15/16	JOHN DEERE	A	Z	C	4	9	BL BL	5 1/2 5 1/2	18 3/8 18 3/8	1 3/8 1 3/8	22 22	B B	C	280469
18 1/2	15 3/4	2 1/4	JOHN DEERE		T	C	3	6	BL BL	5 1/2 5 1/2	18 3/8 18 3/8	1 3/8 1 3/8	22 22	B B	C	261475
18 1/2	15 3/4	2 1/4	JOHN DEERE	A	T	C	3	7	BL BL	5 1/2 5 1/2	18 1/2 18 1/2	C C	22 22	B B	C	271475
18 1/2	15 3/4	3	JOHN DEERE		T	C	4	8	BL BL	5 1/2 5 1/2	18 3/8 18 3/8	C C	22 22	B B	C	278919
18 3/4	13 3/4	3	JOHN DEERE	2240	X	C	4	9		3 3	13 3/4 13 3/4	C C		0 0	N	260754
19 1/8	15	2 1/4	JOHN DEERE	2010 DIESEL	X	C	3	8	GR GR	3 3/8 3 3/8	15 3/4 15 3/4	3/16 3/16		A A	N	221813
19 1/8	15	3	JOHN DEERE	2010 DIESEL	X	C	4	9	GR GR	3 3/8 3 3/8	15 3/4 15 3/4	C C		A A	N	266113
19 1/8	15 3/16	2 1/4	JOHN DEERE	2010 DIESEL	T	C	3	7	GR GR	3 3/8 3 3/8	15 3/4 15 3/4	1/4 1/4		A A	N	265495
19 1/8	15 3/16	2 1/4	JOHN DEERE	2010 DIESEL	T	C	3	7	GR GR	3 3/8 3 3/8	15 3/4 15 3/4	1/8 1/8		A A	N	275112
19 1/8	18 1/8	2 1/4	JOHN DEERE	LOADER	X	C	3	8	GR GR	3 1/4 3 1/4	18 5/8 18 5/8	C C		A A	N	288093
19 1/8	18 9/16	2 1/4	JOHN DEERE	1010 DIESEL	T	C	3	8	GR GR	3 1/4 3 1/4	18 5/8 18 5/8	C C		A A	N	263224
19 1/8	18 9/16	2 1/4	JOHN DEERE	1010 DIESEL	T	C	3	7	GR GR	3 1/4 3 1/4	18 5/8 18 5/8	C C		A A	N	275113
19 3/4	20 1/4	2 1/4	JOHN DEERE	D15-27	T	C	3	6	BL BL	15 7/8 5 3/4	23 1/2 23 1/2	1 7/16 1 7/16	30 30	A A	C	278920
19 3/4	20 1/4	3	JOHN DEERE		T	C	4	6	BL BL	15 3/4 5 3/4	23 1/2 23 1/2	1 3/8 C	30 22	A A	C	278921
19 3/4	20 5/8	3	JOHN DEERE		X	C	4	8	BL BL	6 3/16 6 3/16	22 7/8 22 7/8	1 5/8 1 5/8	22 23	F F	C	280468
19 7/8	18	4 1/2	JOHN DEERE		T	C	6	7	GR GR	5 3/8 5 3/8	18 3/4 18 3/4	C C		A A	N	223253
19 7/8	18 1/8	4 7/16	JOHN DEERE	440A SKIDDER AT42555	S	C	8	8	GR GR	5 3/8 5 3/8	18 3/4 18 3/4	1/4 1/4		A A	N	229032
19 7/8	18 1/8	4 7/16	JOHN DEERE	440A BRASS FINS	Z	B	6	6	GR GR	5 3/8 5 3/8	18 3/4 18 3/4	1/4 1/4		A A	N	286642
20	16 7/8	2 1/4	JOHN DEERE	440A	X	C	3	7	BL BL	5 1/2 5 1/2	18 5/16 18 5/16	1 3/4 1 3/4	20 20	B B	C	281935
20	18 1/8	2 15/16	JOHN DEERE	440A	Z	C	4	8	GR GR	3 1/4 3 1/4	18 3/4 18 3/4	C C		A A	N	225464

Vista-Pro Automotive - Core Catalog

(Cores Sorted by Application)

Height	Width	Depth	Application	Description	Fin Type	Fin Matl	Rows	FPI	BH/TH Type	BH/TH Width	BH/TH Length	BH/TH OHF	BH/TH Bolts	BH/TH Shape	Hdr Support	Part #
JOHN DEERE (Cont)																
20	18 9/16	2 1/4	JOHN DEERE	440	T	C	3	7	GR	3 1/4	18 3/4	C		A	N	223194
									GR	3 1/4	18 3/4	C		A	N	223195
20	18 9/16	3	JOHN DEERE	440	T	C	4	7	GR	3 1/4	18 3/4	C		A	N	223195
									GR	3 1/4	18 3/4	C		A	N	289058
20	18 3/4	2 3/16	JOHN DEERE	440	Z	C	3	9	GR	3 1/4	18 3/4	C		A	N	289058
									GR	3 1/4	18 3/4	C		A	N	286641
20	18 3/4	3	JOHN DEERE	SKIDDER	X	C	4	8	GR	3 1/4	18 3/4	C		A	N	286641
									GR	3 1/4	18 3/4	C		A	N	221234
20 1/8	16 1/4	3	JOHN DEERE	450, 550	X	C	4	8	GR	4 1/2	16 1/2	C		A	N	221234
									GR	4 1/2	16 1/2	C		A	N	225466
20 1/8	16 1/4	4 7/16	JOHN DEERE	MODEL 450C AT39009 BRASS FINS	Z	B	6	8	GR	4 3/4	16 1/2	C		A	N	225466
									GR	4 3/4	16 1/2	C		A	N	229018
20 1/8	16 1/4	4 7/16	JOHN DEERE	450C CRAWLER AT116777	S	C	8	8	GR	4 3/4	16 1/2	C		A	N	229018
									GR	4 3/4	16 1/2	C		A	N	266437
20 1/8	16 1/4	4 5/8	JOHN DEERE		X	C	6	8		4 3/4	16 1/2	C		0	N	266437
										4 3/4	16 1/2	C		0	N	225467
20 1/8	19 3/8	2 3/16	JOHN DEERE	350	Z	C	3	7	GR	3 1/4	19 7/8	C		A	N	225467
									GR	3 1/4	19 7/8	C		A	N	225468
20 1/8	19 3/8	2 15/16	JOHN DEERE	350 RE20981	Z	C	4	7	GR	3 1/4	19 7/8	C		A	N	225468
									GR	3 1/4	19 7/8	C		A	N	266441
20 1/8	19 3/8	3	JOHN DEERE	880	X	C	4	6	GR	3 1/4	19 7/8	C		A	N	266441
									GR	3 1/4	19 7/8	C		A	N	124768
20 1/4	13 3/4	2 5/8	JOHN DEERE		VT	C	4	12	GR	3 1/4	14	C		A	N	124768
									GR	3 1/4	14	C		A	N	225465
20 1/4	13 3/4	2 15/16	JOHN DEERE	400 BACKHOE	Z	C	4	9	GR	3 1/4	14	C		A	N	225465
									GR	3 1/4	14	C		A	N	223196
20 1/4	14 1/16	3	JOHN DEERE	400-600	T	C	4	8	GR	3 1/4	14	C		A	N	223196
									GR	3 1/4	14	C		A	N	124724
20 1/4	14 5/16	2 5/8	JOHN DEERE		VT	C	4	12	GR	3 1/4	14	C		A	N	124724
									GR	3 1/4	14	C		A	N	225508
20 1/4	16 1/4	3 11/16	JOHN DEERE	450B CRAWLER	Z	C	5	7	GR	4 3/4	16 5/8	C		A	N	225508
									GR	4 3/4	16 5/8	C		A	N	221816
20 1/4	16 1/4	3 3/4	JOHN DEERE	450	X	C	5	8	GR	4 3/4	16 5/8	C		A	N	221816
									GR	4 3/4	16 5/8	C		A	N	273800
20 1/4	16 1/4	3 15/16	JOHN DEERE	450	S	C	7	7	GR	4 3/4	16 5/8	C		A	N	273800
									GR	4 3/4	16 5/8	C		A	N	273801
20 1/4	16 1/4	3 15/16	JOHN DEERE	450	S	C	7	7	GR	4 1/2	16 5/8	C		A	N	273801
									GR	4 1/2	16 5/8	C		A	N	225494
20 1/4	16 1/4	4 7/16	JOHN DEERE	450C CRAWLER BRASS FINS	Z	B	6	8	GR	4 3/4	16 5/8	C		A	N	225494
									GR	4 3/4	16 5/8	C		A	N	223613
20 1/4	16 5/16	4 1/2	JOHN DEERE	450	T	C	6	8	GR	4 3/4	16 5/8	C		A	N	223613
									GR	4 3/4	16 5/8	C		A	N	223197
20 1/4	19 11/16	2 1/4	JOHN DEERE	350	T	C	3	8	GR	3 1/4	19 7/8	C		A	N	223197
									GR	3 1/4	19 7/8	C		A	N	221519
20 1/2	18 1/8	3	JOHN DEERE	440	X	C	4	11	GR	3 1/4	18 3/4	C		A	N	221519
									GR	3 1/4	18 3/4	C		A	N	263719
20 1/2	18 9/16	2 1/4	JOHN DEERE	440	T	C	3	8	GR	3 1/4	18 3/4	C		A	N	263719
									GR	3 1/4	18 3/4	C		A	N	278925
20 1/2	18 9/16	3	JOHN DEERE		T	C	4	6	GR	3 1/4	18 3/4	C		A	N	278925
									GR	3 1/4	18 3/4	C		A	N	289769
20 1/2	18 3/4	3	JOHN DEERE	2510	X	C	4	6	GR	3 1/4	18 3/4	C		A	N	289769
									GR	3 1/4	18 3/4	C		A	N	266426
20 5/8	19 3/8	2 1/4	JOHN DEERE	350	X	C	3	6	GR	3 1/4	19 7/8	C		A	N	266426
									GR	3 1/4	19 7/8	C		A	N	

Vista-Pro Automotive - Core Catalog

(Cores Sorted by Application)

Height	Width	Depth	Application	Description	Fin Type	Fin Matl	Rows	FPI	BH/TH Type	BH/TH Width	BH/TH Length	BH/TH OHF	BH/TH Bolts	BH/TH Shape	Hdr Support	Part #
JOHN DEERE (Cont)																
21	16 7/8	2 1/4	JOHN DEERE		T	C	3	7	BL BL	5 1/2 5 1/2	18 3/8 18 3/8	C C	20 20	B B	C	278927
21	16 7/8	2 1/4	JOHN DEERE	A, 60, 620, 630 HDRS BEVELED	X	C	3	7	BL BL	5 1/2 5 1/2	18 3/8 18 3/8	1 3/8 1 3/8	20 20	B B	C	282061
21	16 7/8	2 15/16	JOHN DEERE	A, 60, 620, 630 HDRS BEVELED	Z	C	4	6	BL BL	5 1/2 5 1/2	18 3/8 18 3/8	1 3/8 1 3/8	20 20	B B	C	287561
21	16 7/8	3	JOHN DEERE	620, 630	X	C	4	6	BL BL	5 1/2 5 1/2	18 3/8 18 3/8	1 5/16 1 5/16	20 20	B B	C	221817
21 3/8	24 3/4	2 1/4	JOHN DEERE	COTTON PICKER	T	C	3	7	GR GR	6 3 1/2	25 3/4 25 3/4	1/8 1/8		A A	N	278929
21 1/2	13 3/4	2 15/16	JOHN DEERE	4110	Z	C	4	9	GR GR	3 1/4 3 1/4	14 14	C C		A A	N	225469
21 1/2	13 3/4	3	JOHN DEERE	410	X	C	4	9	GR GR	3 1/4 3 1/4	14 14	C C		A A	N	260761
21 1/2	18 9/16	2 1/4	JOHN DEERE	720	T	C	3	7	BL BL	5 9/16 5 9/16	21 1/2 21 1/2	1 1/4 1 1/4	20 20	C C	C	262050
21 1/2	18 3/4	2 1/4	JOHN DEERE	G-4251-12,999	X	C	3	7	BL BL	5 3/4 5 3/4	21 1/2 21 1/2	1 3/8 1 3/8	22 22	A A	C	280655
21 1/2	19 3/8	1 7/8	JOHN DEERE	720 DIESEL	X	C	2	7	BL BL	5 9/16 5 9/16	21 1/2 21 1/2	C C	20 20	C C	C	288305
21 1/2	19 3/8	2 1/4	JOHN DEERE	G-400	X	C	3	7	BL BL	5 5/8 5 5/8	21 1/2 21 1/2	1 1/4 1 1/4	21 21	C C	C	221818
21 1/2	19 11/16	2 1/4	JOHN DEERE		T	C	3	7	BL BL	5 9/16 5 9/16	21 1/2 21 1/2	1 5/16 1 5/16	20 20	C C	C	262855
21 1/2	19 11/16	2 1/4	JOHN DEERE	70 DIESEL	T	C	3	7	BL BL	5 5/8 5 5/8	21 1/2 21 1/2	1 1/2 1 1/2	22 22	A A	C	273413
21 1/2	20	3	JOHN DEERE	G-13000	X	C	4	7	BL BL	5 9/16 5 9/16	21 1/2 21 1/2	1 1/8 1 1/8	20 20	C C	C	287288
21 1/2	23 3/4	2 1/4	JOHN DEERE	COMBINE	X	C	3	6	GR GR	6 3 1/2	25 3/4 25 3/4	1/2 1/2		A A	N	288095
21 1/2	25	3 11/16	JOHN DEERE	699	Z	C	5	7	GR GR	4 1/4 4 1/4	25 3/4 25 3/4	C C		A A	N	289374
21 1/2	25	3 3/4	JOHN DEERE	699	X	C	5	6	GR GR	4 1/4 4 1/4	25 3/4 25 3/4	C C		A A	N	278933
21 1/2	25 5/8	4 5/8	JOHN DEERE	COMBINE	X	C	6	6	GR GR	5 7/8 5 7/8	25 3/4 25 3/4	C C		A A	N	266307
21 3/4	13 3/4	2 5/8	JOHN DEERE		VT	C	4	12	GR GR	3 1/4 3 1/4	14 14	C C		A A	N	124769
21 3/4	13 3/4	2 7/8	JOHN DEERE	410	S	C	5	9	GR GR	3 1/4 3 1/4	14 14	C C		A A	N	266431
21 3/4	13 3/4	2 15/16	JOHN DEERE		Z	C	4	10	GR GR	3 1/2 3 1/2	14 14	C C		A A	N	286640
22	18	3 3/4	JOHN DEERE	2010 DIESEL	T	C	5	8	GR GR	5 1/4 5 1/4	18 5/8 18 5/8	7/8 7/8		A A	N	275446
22 1/8	24 3/4	4 1/2	JOHN DEERE	540B SKIDDER	T	C	6	9	GR GR	5 7/8 5 7/8	25 7/8 25 7/8	C C		A A	N	223627
22 1/8	25	4 7/16	JOHN DEERE	540B SKIDDER BRASS FINS	Z	B	6	8	GR GR	5 7/8 5 7/8	25 7/8 25 7/8	3/16 3/16		A A	N	225615
22 1/8	25	4 7/16	JOHN DEERE	540B SKIDDER HVY STEEL FINS	Z	S	6	8	GR GR	5 7/8 5 7/8	25 7/8 25 7/8	3/16 3/16		A A	N	225945
22 1/4	18	2 1/4	JOHN DEERE	3010, 3020 AR46448, AR46019	T	C	3	7	GR GR	5 1/4 3 1/4	18 7/8 18 7/8	1 1		A A	N	223198
22 3/8	25	3 3/4	JOHN DEERE	95 COMBINE	X	C	5	6	GR GR	4 3/8 4 3/8	25 7/8 25 7/8	C C		A A	N	286659

Vista-Pro Automotive - Core Catalog

(Cores Sorted by Application)

Height	Width	Depth	Application	Description	Fin Type	Fin Matl	Rows	FPI	BH/TH Type	BH/TH Width	BH/TH Length	BH/TH OHF	BH/TH Bolts	BH/TH Shape	Hdr Support	Part #
JOHN DEERE (Cont)																
22 1/2	18 1/8	2 1/4	JOHN DEERE	3010 TRACTOR	X	C	3	6	GR	5 3/8	18 3/4	2 1/4		A	N	221819
									GR	3 3/8	18 3/4	3/16		A	N	221819
22 1/2	18 1/8	3	JOHN DEERE	2010 DIESEL	X	C	4	8	GR	3 1/4	18 3/4	C		A	N	288561
									GR	3 1/4	18 3/4	C		A	N	288561
22 1/2	18 1/8	3	JOHN DEERE	3020	X	C	4	8	GR	5 3/8	18 3/4	3/16		A	N	289130
									GR	3 3/8	18 3/4	3/16		A	N	289130
22 1/2	18 9/16	2 1/4	JOHN DEERE	3010 TRACTOR	T	C	3	8	GR	5 3/8	18 3/4	7/8		A	N	223203
									GR	3 3/8	18 3/4	7/8		A	N	223203
22 1/2	18 9/16	2 1/4	JOHN DEERE	3010 TRACTOR	T	C	3	6	GR	5 3/8	18 3/4	3/4		A	N	223204
									GR	3 3/8	18 3/4	3/4		A	N	223204
22 1/2	18 9/16	3	JOHN DEERE	3020	T	C	4	8	GR	5 3/8	18 3/4	3/16		A	N	223205
									GR	3 3/8	18 3/4	3/16		A	N	223205
22 1/2	18 9/16	3	JOHN DEERE	2010 DIESEL	T	C	4	7	GR	3 1/4	18 3/4	C		A	N	277161
									GR	3 1/4	18 3/4	C		A	N	277161
22 1/2	18 9/16	3 3/4	JOHN DEERE	2010 DIESEL	T	C	5	8	GR	5 3/8	18 3/4	1/4		A	N	263952
									GR	5 3/8	18 3/4	1/4		A	N	263952
22 1/2	18 3/4	2 7/8	JOHN DEERE	G-421	S	C	5	8	GR	5 3/8	18 3/4	1/8		A	N	221245
									GR	3 3/8	18 3/4	C		A	N	221245
22 1/2	19 1/8	4 1/2	JOHN DEERE	540 SKIDDER	T	C	6	6	GR	5 3/8	19 7/8	C		A	N	265469
									GR	5 3/8	19 7/8	C		A	N	265469
22 1/2	19 1/8	4 1/2	JOHN DEERE	540	T	C	6	8	GR	5 3/8	19 7/8	C		A	N	278942
									GR	5 3/8	19 7/8	C		A	N	278942
22 1/2	25	2 3/16	JOHN DEERE	SKIDDER	Z	C	3	7	GR	4	25 1/2	3/16		A	N	281862
									GR	4	25 1/2	3/16		A	N	281862
22 1/2	25	2 1/4	JOHN DEERE		X	C	3	7	GR	4	25 1/2	3/16		A	N	281647
									GR	4	25 1/2	3/16		A	N	281647
22 1/2	25	3	JOHN DEERE	690	X	C	4	7	GR	4 3/8	25 7/8	C		A	N	260770
									GR	4 3/8	25 7/8	C		A	N	260770
22 1/2	25	3	JOHN DEERE	690 EXPEDITER	X	C	4	8	GR	4 3/8	25 7/8	C		A	N	289565
									GR	4 3/8	25 7/8	C		A	N	289565
22 5/8	19 3/8	4 7/16	JOHN DEERE	540 BRASS FINS	Z	B	6	6	GR	5 3/8	19 7/8	C		A	N	289410
									GR	5 3/8	19 7/8	C		A	N	289410
23	18 9/16	2 1/4	JOHN DEERE		T	C	3	7	GR	5 3/8	18 3/4	C		A	N	223283
									GR	3 3/8	18 3/4	7/8		A	N	223283
23	27 1/2	4 7/16	JOHN DEERE	SKIDDER BRASS FINS	Z	B	6	9	GR	4 3/4	28 3/8	C		A	N	286756
									GR	4 3/4	28 3/8	C		A	N	286756
23 1/4	21 1/4	2 15/16	JOHN DEERE		Z	C	4	10	GR	3 1/2	21 7/8	C		A	N	282777
									GR	3 1/2	21 7/8	C		A	N	282777
23 7/8	20 5/8	3	JOHN DEERE	MOTOR GRADER	X	C	4	6	GR	3 3/8	21 7/8	C		A	N	289446
									GR	3 3/8	21 7/8	C		A	N	289446
23 7/8	20 13/16	3	JOHN DEERE	MOTOR GRADER	T	C	4	6	GR	3 3/8	21 7/8	1/8		A	N	278945
									GR	3 3/8	21 7/8	1/8		A	N	278945
24	36 7/8	3	JOHN DEERE	690A	X	C	4	9	GR	4 3/4	37 1/2	C		A	C	286524
									GR	4 3/4	37 1/2	C		A	C	286524
24	36 7/8	3 3/4	JOHN DEERE	690A	X	C	5	8	GR	4 3/4	37 1/2	C		A	C	289615
									GR	4 3/4	37 1/2	C		A	C	289615
24	37 1/8	3	JOHN DEERE	690A	T	C	4	9	GR	4 3/4	37 1/2	3/4		A	C	278947
									GR	4 3/4	37 1/2	3/4		A	C	278947
24	37 1/8	3 3/4	JOHN DEERE	690A	T	C	5	8	GR	4 3/4	37 1/2	C		A	C	278948
									GR	4 3/4	37 1/2	C		A	C	278948
24 3/8	19 3/8	2 1/4	JOHN DEERE	4010	X	C	3	8	GR	5 3/8	19 7/8	2 1/4		A	C	221506
									GR	3 1/4	19 7/8	1/4		A	C	221506
24 3/8	19 3/8	2 7/8	JOHN DEERE	4010, 4020	S	C	5	7	GR	5 3/8	19 7/8	1/8		A	C	229019
									GR	3 1/4	19 7/8	1/8		A	C	229019

Vista-Pro Automotive - Core Catalog

(Cores Sorted by Application)

Height	Width	Depth	Application	Description	Fin Type	Fin Matl	Rows	FPI	BH/TH Type	BH/TH Width	BH/TH Length	BH/TH OHF	BH/TH Bolts	BH/TH Shape	Hdr Support	Part #
JOHN DEERE (Cont)																
24 3/8	19 3/8	2 15/16	JOHN DEERE	4010, 4020	Z	C	4	7	GR	5 3/8	19 7/8	3/4		A	C	273617
									GR	3 1/4	19 7/8	1/4		A		
24 3/8	19 3/8	3	JOHN DEERE	4010, 4020 AR 46449	X	C	4	8	GR	5 3/8	19 7/8	2 1/4		A	C	221510
									GR	3 1/4	19 7/8	1/4		A		
24 3/8	19 3/8	3	JOHN DEERE	4020 TRACTOR AR 49455	X	C	4	8	GR	5 3/8	19 7/8	3/16		A	C	221820
									GR	3 1/4	19 7/8	3/16		A		
24 3/8	19 1/2	3	JOHN DEERE	4020	B	C	4	8	GR	5 3/8	19 7/8	1/8		A	C	229516
									GR	3 1/4	19 7/8	1/8		A		
24 3/8	19 11/16	2 1/4	JOHN DEERE	4010	T	C	3	8	GR	5 3/8	19 7/8	2 1/4		A	C	263240
									GR	3 1/4	19 7/8	1/4		A		
24 3/8	20	2 1/4	JOHN DEERE	4020 TRACTOR	X	C	3	8	GR	5 3/8	19 7/8	1/8		A	C	221246
									GR	3 1/4	19 7/8	1/8		A		
24 1/2	19 3/8	2 1/4	JOHN DEERE	4010	X	C	3	7	GR	5 3/8	19 7/8	7/8		A	C	221799
									GR	3 1/4	19 7/8	7/8		A		
24 1/2	19 3/8	2 15/16	JOHN DEERE	FEED LOT BRASS FINS	Z	B	4	7	GR	5 3/8	19 7/8	3/16		A	C	286463
									GR	3 1/4	19 7/8	3/16		A		
24 1/2	19 3/8	3	JOHN DEERE	4020	X	C	4	9	GR	5 3/8	19 7/8	3/16		A	C	221787
									GR	3 1/4	19 7/8	C		A		
24 1/2	19 11/16	2 1/4	JOHN DEERE	4010	T	C	3	8	GR	5 7/16	19 7/8	1		A	C	274953
									GR	3 1/4	19 7/8	3/4		A		
24 1/2	27	3	JOHN DEERE	GD544	T	C	4	7	GR	4 1/4	28 1/4	C		A	C	223614
									GR	4 1/4	28 1/4	C		A		
24 1/2	27 1/2	3	JOHN DEERE	GD544	X	C	4	6	GR	4 1/4	28 1/4	C		A	C	289517
									GR	4 1/4	28 1/4	C		A		
24 7/8	19 11/16	2 1/4	JOHN DEERE	4030	T	C	3	8	GR	5 1/2	20	1/8		A	C	277364
									GR	3 3/8	20	1/8		A		
25	21 1/4	3	JOHN DEERE	4320	X	C	4	9	GR	6	21 7/8	C		A	C	221788
									GR	3 1/2	21 7/8	C		A		
25	21 1/4	3	JOHN DEERE	4320	X	C	4	11	GR	6	21 7/8	5/16		A	C	260776
									GR	3 1/2	21 7/8	5/16		A		
25	21 1/4	3	JOHN DEERE	4320	X	C	4	9	GR	6	21 7/8	C		A	C	289420
									GR	3 1/2	21 7/8	C		A		
25	21 3/8	3	JOHN DEERE	4320	T	C	4	9	GR	6	21 7/8	C		A	C	223206
									GR	3 1/2	21 7/8	C		A		
25	21 1/2	3	JOHN DEERE		B	C	4	7	GR	6	21 7/8	C		A	C	277365
									GR	3 1/2	21 7/8	C		A		
25 1/2	19 3/8	3	JOHN DEERE	4010, 4020	X	C	4	10	GR	5 3/8	19 7/8	3/8		A	C	221507
									GR	3 1/4	19 7/8	C		A		
25 1/2	19 3/8	3	JOHN DEERE	4230 AT 60371	X	C	4	10	GR	5 3/8	20	3/16		A	C	221798
									GR	3 1/4	20	3/16		A		
25 1/2	19 3/8	3	JOHN DEERE		X	C	4	10	GR	5 3/8	20	1/4		A	C	266240
									GR	3 3/4	20	1/4		A		
25 1/2	19 3/8	3 7/16	JOHN DEERE		S	C	6	10	GR	5 3/8	20	1/4		A	C	266541
									GR	3 3/4	20	1/4		A		
25 1/2	19 3/8	3 7/16	JOHN DEERE	4230	S	C	6	10	GR	5	20	1/4		A	C	266542
									GR	3 3/4	20	1/4		A		
25 1/2	19 3/8	3 3/4	JOHN DEERE	4230	X	C	5	10	GR	5	20	1/4		A	C	221499
									FR	3 3/4	20	C		A		
25 1/2	19 3/8	3 3/4	JOHN DEERE	4230	X	C	5	9	GR	5	20	3/16		A	C	221797
									GR	3 3/4	20	C		A		
25 1/2	19 3/8	3 3/4	JOHN DEERE	CAN USE 221499	X	C	5	10	GR	4 7/8	20	1/4		A	C	266220
									GR	4	20	1/4		A		
25 1/2	19 11/16	3	JOHN DEERE	4230	T	C	4	9	GR	5	20	3/16		A	C	223207
									GR	3 3/4	20	3/16		A		

Vista-Pro Automotive - Core Catalog

(Cores Sorted by Application)

Height	Width	Depth	Application	Description	Fin Type	Fin Matl	Rows	FPI	BH/TH Type	BH/TH Width	BH/TH Length	BH/TH OHF	BH/TH Bolts	BH/TH Shape	Hdr Support	Part #
JOHN DEERE (Cont)																
25 1/2	19 11/16	3	JOHN DEERE	4230	T	C	4	10	GR	5 3/8	20	3/16		A	C	223212
									GR	3 1/4	20	C		A		
25 1/2	19 11/16	3 3/4	JOHN DEERE	4230	T	C	5	9	GR	5	20	3/16		A	C	223227
									GR	3 3/4	20	C		A		
25 3/4	27 1/2	3 11/16	JOHN DEERE	GD544	Z	C	5	6	GR	4 1/4	28 1/4	C		A	C	281920
									GR	4 1/4	28 1/4	C		A		
25 3/4	27 9/16	3 3/4	JOHN DEERE	GD544	T	C	5	6	GR	4 1/4	28 1/4	C		A	C	265678
									GR	4 1/4	28 1/4	C		A		
26	26 1/4	3	JOHN DEERE	SCRAPER	X	C	4	7	GR	4 1/8	27 1/4	1/4		A	C	266305
									GR	4 1/8	27 1/4	1/4		A		
26 1/2	20 5/8	2 1/4	JOHN DEERE	ROLLER RE33358	X	C	3	7	GR	3 1/2	22	C		A	C	221247
									GR	3 1/2	22	C		A		
26 1/2	20 5/8	2 15/16	JOHN DEERE		Z	C	4	7	GR	3 1/2	22	C		A	C	286544
									GR	3 1/2	22	C		A		
26 5/8	21 7/8	3 11/16	JOHN DEERE	4240	Z	C	5	9	GR	4 1/4	22	1/8		A	C	273629
									GR	4 1/4	22	1/8		A		
26 3/4	21 7/8	2 7/8	JOHN DEERE		S	C	5	8	GR	4 1/4	22	1/8		A	C	272900
									GR	4 1/4	22	1/8		A		
26 3/4	21 7/8	3	JOHN DEERE	4240	X	C	4	8	GR	4 1/4	22	C		A	C	282571
									GR	4 1/4	22	C		A		
26 3/4	21 7/8	3 7/16	JOHN DEERE	4240 RE21898	S	C	6	9	GR	4 1/4	22	3/16		A	C	229020
									GR	4 1/4	22	3/16		A		
27	21 1/4	3	JOHN DEERE	4430	X	C	4	9	GR	5 7/8	21 3/4	C		A	C	289524
									GR	4 1/4	21 3/4	C		A		
27	21 1/4	3 7/16	JOHN DEERE	4430	S	C	6	9	GR	5 7/8	21 3/4	C		A	C	229021
									GR	3 7/8	21 3/4	C		A		
27	21 3/8	3 3/4	JOHN DEERE	4430	T	C	5	10	GR	5 7/8	21 3/4	1 3/4		A	C	278955
									GR	3 7/8	21 3/4	C		A		
27	21 7/8	3 11/16	JOHN DEERE	4430	Z	C	5	10	GR	5 7/8	21 3/4	1 1/8		A	C	225534
									GR	3 7/8	21 3/4	C		A		
27 1/8	21 3/8	3	JOHN DEERE	4430	T	C	4	9	GR	5 7/8	21 3/4	C		A	C	223208
									GR	3 7/8	21 3/4	1/8		A		
27 1/8	21 3/8	3 3/4	JOHN DEERE	4430	T	C	5	9	GR	5 7/8	21 3/4	C		A	C	223214
									GR	3 7/8	21 3/4	C		A		
27 1/8	21 1/2	3 3/4	JOHN DEERE	4430	B	C	5	7	GR	5 7/8	21 3/4	C		A	C	272757
									GR	3 7/8	21 3/4	C		A		
27 1/8	21 7/8	2 7/8	JOHN DEERE	4460	S	C	5	9	GR	5 7/8	21 3/4	1 5/8		A	C	266547
									GR	3 7/8	21 3/4	1/8		A		
27 1/8	21 7/8	3 7/16	JOHN DEERE	4440, 4050 AR102736, AR95849	S	C	6	9	GR	4 1/4	21 15/16	3/8		A	C	229041
									GR	4 1/4	21 15/16	3/8		A		
27 1/8	21 7/8	3 7/16	JOHN DEERE	4430	S	C	6	9	GR	5 7/8	21 3/4	1 3/4		A	C	266546
									GR	3 7/8	21 3/4	1/4		A		
27 1/8	21 7/8	3 3/4	JOHN DEERE	4430	X	C	5	9	GR	5 7/8	21 3/4	C		A	C	265892
									GR	3 7/8	21 3/4	C		A		
27 1/8	21 15/16	3	JOHN DEERE	4430	T	C	4	9	GR	6	22	1 3/4		A	C	223209
									GR	3 7/8	22	1/4		A		
27 1/4	25	3 11/16	JOHN DEERE	BRASS FINS	Z	B	5	8	GR	4 1/4	25 7/8	C		A	C	282747
									GR	4 1/4	25 7/8	C		A		
27 1/2	21 1/4	3	JOHN DEERE	4430	X	C	4	9	GR	6	21 3/4	C		A	C	286402
									GR	3 7/8	21 3/4	C		A		
27 1/2	21 3/8	3	JOHN DEERE	4430	T	C	4	9	GR	6	21 3/4	C		A	C	278957
									GR	3 7/8	21 3/4	C		A		
27 3/4	21 1/4	3	JOHN DEERE	4520, 4620	X	C	4	9	GR	6	22	C		A	C	289170
									GR	3 1/2	22	C		A		

Vista-Pro Automotive - Core Catalog

(Cores Sorted by Application)

Height	Width	Depth	Application	Description	Fin Type	Fin Matl	Rows	FPI	BH/TH Type	BH/TH Width	BH/TH Length	BH/TH OHF	BH/TH Bolts	BH/TH Shape	Hdr Support	Part #
JOHN DEERE (Cont)																
27 3/4	21 1/2	3	JOHN DEERE	4520	B	C	4	7	GR	6	22	C		A	C	277366
									GR	3 1/2	22	C		A		
27 3/4	21 15/16	3	JOHN DEERE	4520	T	C	4	9	GR	6	22	C		A	C	265419
									GR	3 1/2	22	C		A		
27 3/4	27 9/16	3 3/4	JOHN DEERE	TRACTOR	T	C	5	9	GR	4 1/4	28 3/16	C		A	C	265893
									GR	4 1/4	28 3/16	C		A		
27 7/8	25 5/8	2 3/16	JOHN DEERE	5010	Z	C	3	9	GR	6	25 3/4	3/4		A	C	288642
									GR	3 1/4	25 3/4	C		A		
27 7/8	25 5/8	3	JOHN DEERE	5020, 7520	X	C	4	8	GR	6	25 3/4	3/16		A	C	289260
									GR	3 1/4	25 3/4	3/16		A		
27 7/8	27 1/2	4 7/16	JOHN DEERE	644A SKIDDER BRASS FINS	Z	B	6	8	GR	4 3/4	28 3/8	C		A	C	289500
									GR	4 3/4	28 3/8	C		A		
27 7/8	27 1/2	4 1/2	JOHN DEERE	644A SKIDDER BRASS FINS FACE DIPPED	B	B	6	6	GR	4 3/4	28 3/8	C		A	C	278960
									GR	4 3/4	28 3/8	C		A		
27 7/8	27 9/16	4 1/2	JOHN DEERE	644A SKIDDER	T	C	6	7		4 3/4	28 3/8	C		0	C	265910
										4 3/4	28 3/8	C		0		
28	20	4 7/16	JOHN DEERE	550 CRAWLER BRASS FINS HVY T/BTM HDRS	Z	B	6	8	BH	7 5/8	21 3/8	C	28	A	C	225214
									BH	7 5/8	21 3/8	C	28	A		
28	20	4 7/16	JOHN DEERE	550 CRAWLER HVY BTM HDR BRASS FINS	Z	B	6	9	BL	7 5/8	21 3/8	C	34	A	C	225645
									BH	7 5/8	21 3/8	C	34	A		
28	20	4 7/16	JOHN DEERE	550 CRAWLER HVY STEEL FINS	Z	S	6	8	BL	7 5/8	21 3/8	C	28	A	C	225943
									BL	7 5/8	21 3/8	C	28	A		
28	20	4 7/16	JOHN DEERE	550 CRAWLER HVY BTM HDR HVY STEEL FINS	Z	S	6	9	BL	7 5/8	21 3/8	C	34	A	C	225944
									BH	7 5/8	21 3/8	C	34	A		
28	20	4 1/2	JOHN DEERE	550 CRAWLER HVY T/BTM HDRS BRASS FINS FACE DIPPED	B	B	6	8	BH	7 5/8	21 3/8	C	34	A	C	272502
									BH	7 5/8	21 3/8	C	34	A		
28	20	4 1/2	JOHN DEERE	550 CRAWLER HVY T/BTM HDRS BRASS FINS FACE DIPPED	B	B	6	8	BH	7 5/8	21 3/8	C	28	A	C	272623
									BH	7 5/8	21 3/8	C	28	A		
28	25 5/8	3	JOHN DEERE	5010	X	C	4	9	GR	6	25 3/4	C		A	C	289617
									GR	3 1/4	25 3/4	C		A		
28	25 7/8	3	JOHN DEERE	5010, 5020	T	C	4	7	GR	6	25 3/4	1/8		A	C	277040
									GR	3 1/4	25 3/4	1/8		A		
28	26 7/8	3 11/16	JOHN DEERE	7700 COMBINE	Z	C	5	7	GR	4 1/4	28 3/8	C		A	C	225154
									GR	4 1/4	28 3/8	C		A		
28	26 7/8	3 11/16	JOHN DEERE	7700 COMBINE HVY STEEL FINS	Z	S	5	7	GR	4 1/4	28 3/8	C		A	C	225919
									GR	4 1/4	28 3/8	C		A		
28	27	3	JOHN DEERE	6000 COMBINE	B	C	4	7	GR	4 1/4	28 3/8	C		A	C	278961
									GR	4 1/4	28 3/8	C		A		
28	27	3 3/4	JOHN DEERE	6600 COMBINE AH 87820	B	C	5	6	GR	4 1/4	28 3/8	C		A	C	229517
									GR	4 1/4	28 3/8	C		A		
28	27	3 3/4	JOHN DEERE	4400 COMBINE	T	C	5	6	GR	4 1/4	28 3/8	C		A	C	265894
									GR	4 1/4	28 3/8	C		A		
28 1/4	21 1/4	3	JOHN DEERE	4020	X	C	4	10	GR	5 7/8	22	C		A	C	266193
									GR	3 3/8	22	C		A		
28 1/4	21 1/4	3	JOHN DEERE	4420	X	C	4	9	GR	5 7/8	22	C		A	C	289868
									GR	3 1/2	22	C		A		
28 1/4	21 15/16	3	JOHN DEERE	4420	T	C	4	9	GR	5 7/8	22	C		A	C	278964
									GR	3 1/2	22	C		A		
28 1/2	21 7/8	3 3/4	JOHN DEERE		X	C	5	9	GR	4 1/4	21 7/8	1/4		A	C	281631
									GR	4 1/4	21 7/8	1/4		A		
28 1/2	26 7/8	3	JOHN DEERE	6600	X	C	4	9	GR	4 1/4	28 1/4	C		A	C	260783
									GR	4 1/4	28 1/4	C		A		

Vista-Pro Automotive - Core Catalog

(Cores Sorted by Application)

Height	Width	Depth	Application	Description	Fin Type	Fin Matl	Rows	FPI	BH/TH Type	BH/TH Width	BH/TH Length	BH/TH OHF	BH/TH Bolts	BH/TH Shape	Hdr Support	Part #
JOHN DEERE (Cont)																
28 5/8	21 7/8	3 7/16	JOHN DEERE	4250, 4450 RE21893	S	C	6	9	GR	4 3/16	21 7/8	3/16		A	C	229022
									GR	4 3/16	21 7/8	3/16		A	C	
28 5/8	21 7/8	3 15/16	JOHN DEERE	4440	S	C	7	9	GR	4 1/4	21 7/8	C		A	C	273805
									GR	4 1/4	21 7/8	C		A	C	
28 3/4	21 7/8	3 3/4	JOHN DEERE	4460, 4480	X	C	5	10	GR	4 1/4	21 7/8	3/16		A	C	286982
									GR	4 1/4	21 7/8	3/16		A	C	
29	21 7/8	3	JOHN DEERE	4630	X	C	4	9	GR	6	21 7/8	2		A	C	289442
									GR	3 7/8	21 7/8	3/4		A	C	
29	21 7/8	3 7/16	JOHN DEERE	4250	S	C	6	10	GR	5	22 1/4	C		A	C	229023
									GR	4	22 1/4	C		A	C	
29	21 7/8	3 3/4	JOHN DEERE	4630	X	C	5	11	GR	6	21 7/8	11/16		A	C	289876
									GR	3 7/8	21 7/8	C		A	C	
29	21 15/16	3 3/4	JOHN DEERE	4630, 4640	T	C	5	10	GR	6	21 7/8	1/8		A	C	223210
									GR	3 7/8	21 7/8	C		A	C	
29	22	3 3/4	JOHN DEERE	4630	B	C	5	7	GR	6	21 7/8	5/8		A	C	272756
									GR	3 7/8	21 7/8	C		A	C	
29	26 1/4	3 7/16	JOHN DEERE	4850	S	C	6	8	GR	5	26 3/4	C		A	C	229176
									GR	4	26 3/4	C		A	C	
29 1/8	25 5/16	3 3/4	JOHN DEERE	4440	T	C	5	9	GR	4 3/8	25 3/4	3/16		A	C	223211
									GR	4 3/8	25 3/4	3/16		A	C	
29 1/8	25 5/8	3 7/16	JOHN DEERE	4440	S	C	6	9	GR	4 3/8	25 3/4	1/8		A	C	229177
									GR	4 3/8	25 3/4	1/8		A	C	
29 1/8	25 5/8	3 3/4	JOHN DEERE	4440	X	C	5	9	GR	4 3/8	25 3/4	C		A	C	286966
									GR	4 3/8	25 3/4	C		A	C	
29 1/4	21 1/4	3 3/4	JOHN DEERE	4440	X	C	5	11	GR	6	21 7/8	C		A	C	221789
									GR	3 7/8	21 7/8	C		A	C	
29 1/4	21 1/4	3 3/4	JOHN DEERE	3660	X	C	5	11	GR	6	21 7/8	1 3/4		A	C	289527
									GR	3 7/8	21 7/8	C		A	C	
29 1/4	21 7/8	3 7/16	JOHN DEERE	4630, 4030	S	C	6	9	GR	6	21 7/8	3/4		A	C	266544
									GR	3 7/8	21 7/8	C		A	C	
29 1/4	21 7/8	3 3/4	JOHN DEERE	4640	X	C	5	9	GR	6	21 7/8	3/4		A	C	221515
									GR	3 7/8	21 7/8	C		A	C	
29 1/4	21 7/8	3 3/4	JOHN DEERE	4450	X	C	5	11	GR	5	22 1/4	C		A	C	221795
									GR	4	22 1/4	C		A	C	
29 1/4	21 15/16	3 3/4	JOHN DEERE	4460	T	C	5	10	GR	6	21 7/8	3/4		A	C	223220
									GR	3 7/8	21 7/8	C		A	C	
29 1/4	21 15/16	3 3/4	JOHN DEERE	4440, 4640	T	C	5	10	GR	6	21 7/8	C		A	C	223238
									GR	3 7/8	21 7/8	C		A	C	
29 1/4	22	3 3/4	JOHN DEERE	4630	B	C	5	7	GR	6	21 7/8	3/4		A	C	272755
									GR	3 7/8	21 7/8	C		A	C	
29 1/4	25 5/16	3 3/4	JOHN DEERE	4640, 9940 RE21896, AN190887	T	C	5	10	GR	4 3/8	25 3/4	C		A	C	223224
									GR	4 3/8	25 3/4	C		A	C	
29 3/8	21 7/8	3 7/16	JOHN DEERE	4630	S	C	6	7	GR	6	21 7/8	C		A	C	273806
									GR	3 7/8	21 7/8	C		A	C	
29 5/8	25	2 15/16	JOHN DEERE	678 LOADER	Z	C	4	9	GR	4 3/8	25 7/8	3/16		A	C	282716
									GR	4 3/8	25 7/8	3/16		A	C	
29 5/8	25 5/16	3	JOHN DEERE	670A AT71241	T	C	4	9	GR	4 3/8	25 7/8	1/8		A	C	272516
									GR	4 3/8	25 7/8	1/8		A	C	
29 3/4	30 3/8	3 3/4	JOHN DEERE	860	T	C	5	10	GR	4 1/4	31	C		A	C	278968
									GR	4 1/4	31	C		A	C	
29 3/4	30 5/8	3 3/4	JOHN DEERE	740, 750	X	C	5	6	GR	4 1/4	31	C		A	C	266304
									GR	4 1/4	31	C		A	C	
29 3/4	30 5/8	3 3/4	JOHN DEERE	860 SCRAPER	X	C	5	9	GR	4 1/4	31	C		A	C	289651
									GR	4 1/4	31	C		A	C	

Vista-Pro Automotive - Core Catalog

(Cores Sorted by Application)

Height	Width	Depth	Application	Description	Fin Type	Fin Matl	Rows	FPI	BH/TH Type	BH/TH Width	BH/TH Length	BH/TH OHF	BH/TH Bolts	BH/TH Shape	Hdr Support	Part #
JOHN DEERE (Cont)																
29 7/8	26 1/4	3 7/16	JOHN DEERE	4840	S	C	6	11	GR	6 3/8	26 3/4	C		A	C	266540
									GR	4	26 3/4	C		A		
29 7/8	26 1/4	3 3/4	JOHN DEERE	4840	X	C	5	10	GR	6 3/8	26 3/4	1 1/4		A	C	221790
									GR	4	26 3/4	C		A		
30	29 1/4	5 1/4	JOHN DEERE	FORKLIFT	T	C	7	9	GR	5 3/4	29 1/2	C		A	C	223615
									GR	5 3/4	29 1/2	C		A		
30	29 3/8	5 3/16	JOHN DEERE	644B SCRAPER BRASS FINS	Z	B	7	9	GR	5 3/4	29 1/2	C		A	C	225617
									GR	5 3/4	29 1/2	C		A		
30	29 13/16	3 3/4	JOHN DEERE	740 AT78645	T	C	5	6	GR	4 1/2	31 1/4	C		A	C	265499
									GR	4 1/2	31 1/4	C		A		
30 1/8	26 1/4	3 7/16	JOHN DEERE	4640	S	C	6	9	GR	6 7/16	26 3/4	1 1/2		A	C	229024
									GR	4	26 3/4	C		A		
30 1/8	26 1/4	3 3/4	JOHN DEERE	4840	X	C	5	9	GR	6 1/2	26 3/4	C		A	C	221861
									GR	4	26 3/4	C		A		
30 1/8	26 1/4	3 3/4	JOHN DEERE	4640	X	C	5	9	GR	6 1/2	26 3/4	1 1/2		A	C	265914
									GR	4	26 3/4	1/4		A		
30 1/8	26 1/4	3 15/16	JOHN DEERE	4840	S	C	7	9	GR	6 7/16	26 3/4	C		A	C	229009
									FR	4	26 3/4	C		A		
30 1/2	16 5/16	4 1/2	JOHN DEERE		T	C	6	9	BL	7 1/2	19 1/4	C	30	A	C	272903
									BL	7 1/2	19 1/4	C	30	A		
31	27 9/16	3	JOHN DEERE	770A GRADER AT64734	T	C	4	9	GR	4 1/4	28 1/4	1/8		A	C	272506
									GR	4 1/4	28 1/4	1/8		A		
32 3/16	28 3/4	5 3/16	JOHN DEERE	644D HVY STEEL FINS	Z	S	7	9	GR	5 3/4	29 7/16	C		A	C	225931
									GR	5 3/4	29 7/16	C		A		
32 1/2	29	5 1/4	JOHN DEERE	LOADER BRASS FINS FACE DIPPED	B	B	7	7	GR	5 3/4	29 5/8	C		A	C	272507
									GR	5 3/4	29 5/8	C		A		
32 5/8	26 7/8	3 11/16	JOHN DEERE	6600 COMBINE AH85641	Z	C	5	7	GR	4 1/4	28 1/4	C		A	C	225472
									GR	4 1/4	28 1/4	C		A		
32 5/8	27	3 3/4	JOHN DEERE	7700 COMBINE AH124728	T	C	5	6	GR	4 1/4	28 1/4	1/8		A	C	223215
									GR	4 1/4	28 1/4	1/8		A		
32 3/4	20 1/2	6	JOHN DEERE	850 AT80348 HVY T/BTM HDRS BRASS FINS FACE DIPPED	B	B	8	7	BH	9 1/8	22 1/2	C	40	A	C	272508
									BH	9 1/8	22 1/2	C	40	A		
32 7/8	20	5 3/16	JOHN DEERE	HVY BTM HDR BRASS FINS	Z	B	7	6	BL	9 1/8	22 1/2	C	40	A	C	225631
									BH	9 1/8	22 1/2	C	40	A		
32 7/8	20	5 3/16	JOHN DEERE	HVY BTM HDR HVY STEEL FINS	Z	S	7	6	BL	9 1/8	22 1/2	C	40	A	C	225942
									BH	9 1/8	22 1/2	C	40	A		
32 7/8	20 5/8	6	JOHN DEERE	HVY BTM HDR BRASS FINS	Z	B	8	9	BL	9 1/8	22 1/2	C	40	A	C	225632
									BH	9 1/8	22 1/2	C	40	A		
32 7/8	20 5/8	6	JOHN DEERE	HVY BTM HDR HVY STEEL FINS	Z	S	8	9	BL	9 1/8	22 1/2	C	40	A	C	225941
									BH	9 1/8	22 1/2	C	40	A		
32 7/8	20 13/16	6	JOHN DEERE	AT80348 HVY T/BTM HDRS	T	C	8	9	BH	9 1/8	22 1/2	C	40	A	C	266565
									BH	9 1/8	22 1/2	C	40	A		
33	21 1/4	3	JOHN DEERE		X	C	4	9	GR	6	22	5/16		A	C	260784
									GR	3 1/2	22	5/16		A		
34	15 5/8	5 3/16	JOHN DEERE	750 CRAWLER BRASS FINS	Z	B	7	9	BL	8	17	C	24	A	C	225428
									BL	8	17	C	24	A		
34	16 5/16	5 1/4	JOHN DEERE	750 CRAWLER AT52689 HVY BTM HDR	T	C	7	8	BL	8	17	C	24	A	C	223616
									BH	8	17	C	24	A		
34	16 5/16	5 1/4	JOHN DEERE	750 CRAWLER AT52689 HVY BTM HDR BRASS FINS FACE DIPPED	T	B	7	8	BL	8	17	C	24	A	C	223622
									BH	8	17	C	24	A		
34	16 1/2	5 1/4	JOHN DEERE	HVY T/BTM HDRS BRASS FINS FACE DIPPED	B	B	7	7	BH	8	17	C	24	A	C	272896
									BH	8	17	C	24	A		

Vista-Pro Automotive - Core Catalog

(Cores Sorted by Application)

Height	Width	Depth	Application	Description	Fin Type	Fin Matl	Rows	FPI	BH / TH Type	BH / TH Width	BH / TH Length	BH / TH OHF	BH / TH Bolts	BH / TH Shape	Hdr Support	Part #	
JOHN DEERE (Cont)																	
34	17 1/2	5 3/16	JOHN DEERE	HVY STEEL FINS 4 CRNRS OF CORE NOTCHED	Z	S	7	8	BL BL	8 1/8 8 1/8	18 9/16 18 9/16	C C	32 32	A A	C C	225920	
34	31 1/2	4 1/2	JOHN DEERE	5400	B	C	6	7	GR GR	6 6	32 1/2 32 1/2	C C		A A	C C	272898	
34 1/4	27 1/2	3 11/16	JOHN DEERE	8630	Z	C	5	11	SQ SQ	4 1/4 4 1/4	28 28	C C		A A	C C	286895	
34 1/4	27 1/2	3 3/4	JOHN DEERE	8430, 8630	X	C	5	9	GR GR	4 1/4 4 1/4	28 28	C C		A A	C C	221514	
34 1/4	27 1/2	3 15/16	JOHN DEERE	8630 AR76840	S	C	7	9	GR GR	4 1/4 4 1/4	28 28	C C		A A	C C	229025	
34 1/4	27 9/16	3 3/4	JOHN DEERE	8430, 8630	T	C	5	9	GR GR	4 1/4 4 1/4	28 28	C C		A A	C C	272509	
34 1/2	19 3/8	3	JOHN DEERE	554-E	X	C	4	7	GR GR	4 3/4 4 3/4	20 20		3/16 3/16	A A	C C	282769	
35	46	6	JOHN DEERE	862 SCRAPER HVY T/BTM HDRS BRASS FINS	B	B	8	8	BH BH	8 7/8 8 7/8	48 5/8 48 5/8	C C	58 58	A A	CC CC	272510	
35	46 1/4	6	JOHN DEERE	SCRAPER HVY T/BTM HDRS BRASS FINS	Z	B	8	10	BH BH	8 7/8 8 7/8	48 5/8 48 5/8	C C	58 58	A A	CC CC	285190	
38	16 1/4	5 3/16	JOHN DEERE	755 LOADER HVY T/BTM HDRS BRASS FINS END HOLES 2"	Z	B	7	9	BH BH	8 1/8 8 1/8	18 1/2 18 1/2	C C	32 32	A A	C C	225633	
38	16 1/4	5 3/16	JOHN DEERE	755 LOADER HVY T/BTM HDRS HVY STEEL FINS END HOLES 1 13/16"	Z	S	7	9	BH BH	8 1/8 8 1/8	18 1/2 18 1/2	C C	32 32	A A	C C	225932	
38	16 1/4	5 3/16	JOHN DEERE	755 LOADER HVY T/BTM HDRS HVY STEEL FINS END HOLES 2"	Z	S	7	9	BH BH	8 1/8 8 1/8	18 1/2 18 1/2	C C	32 32	A A	C C	225940	
38	16 5/16	5 1/4	JOHN DEERE	755 LOADER AT52690 HVY T/BTM HDRS BRASS FINS FACE DIPPED	T	B	7	7	BH BH	8 1/4 8 1/4	17 17	C C	24 24	A A	C C	272511	
38	16 1/2	5 1/4	JOHN DEERE	655, 755 AT104825 HVY T/BTM HDRS BRASS FINS FACE DIPPED	B	B	7	8	BH BH	8 1/8 8 1/8	18 1/2 18 1/2	C C	32 32	A A	C C	272512	
41 1/2	20	6	JOHN DEERE	855 AT54889 HVY T/BTM HDRS BRASS FINS	Z	B	8	8	BH BH	9 1/8 9 1/8	22 1/2 22 1/2	C C	40 40	A A	C C	282564	
41 1/2	26 7/8	3 15/16	JOHN DEERE	8640 HVY T/BTM HDRS	S	C	7	10	BH BH	6 1/8 7 1/8	28 5/8 28 5/8	C C	36 38	A A	C C	229202	
41 1/2	26 7/8	3 15/16	JOHN DEERE	8640 HVY T/BTM HDRS	S	C	7	9	BH BH	6 1/8 6 1/8	28 5/8 28 5/8	C C	40 40	A A	C C	272902	
48 3/4	38 1/8	5 3/16	JOHN DEERE	AT103580 HVY T/BTM HDRS HVY STEEL FINS 4 CRNRS OF CORE NOTCHED	Z	S	7	9	BH BH	8 1/8 8 1/8	40 40	C C	46 46	A A	C C	225933	
49 3/4	33 3/4	3 3/4	JOHN DEERE	8850 AT10345 HVY T/BTM HDRS	T	C	5	8	BH BH	7 1/2 7 1/2	35 35	C C	44 44	A A	C C	272905	
JOY MANUFACTURING																	
23	23 5/8	2 1/4	JOY MANUFACTURING	COMPRESSOR	T	C	3	10	GR GR	3 1/8 3 1/8	24 24	C C		A A	N A	279437	
28 1/2	13 3/4	2 3/8	JOY MANUFACTURING	185 CFM COMPRESSOR 519294-10	R	C	4	10	GR GR	3 3/8 3 3/8	14 3/8 14 3/8	C C		A A	C C	226529	
32	31 1/4	2 7/8	JOY MANUFACTURING	519294-0011 HVY BTM HDR	R	C	5	10	BL BH	9 3/8 6 1/2	32 3/4 32 3/4		3 1/4 1 7/8	50 46	A A	C C	226530
37 1/2	46 1/8	2 1/4	JOY MANUFACTURING	RPS 600DB HVY T/BTM HDRS	T	C	3	8	BH BH	5 7/8 5 7/8	48 3/4 48 3/4	C C	56 56	A A	CC CC	223254	
46	46 1/4	2 7/8	JOY MANUFACTURING	HVY BTM HDR	R	C	5	10	BL BH	5 7/8 5 7/8	48 48	C C	56 56	A A	CC CC	226532	

Vista-Pro Automotive - Core Catalog

(Cores Sorted by Application)

Height	Width	Depth	Application	Description	Fin Type	Fin Matl	Rows	FPI	BH/TH Type	BH/TH Width	BH/TH Length	BH/TH OHF	BH/TH Bolts	BH/TH Shape	Hdr Support	Part #	
JOY MANUFACTURING (Cont)																	
51	51 3/16	3 3/4	JOY MANUFACTURING	HVY T/BTM HDRS	T	C	5	8	BH BH	7 1/4 7 1/4	54 54	C C	62 62	A A	CC	223312	
KENWORTH																	
31	3/4	39 15/16	4 1/2	KENWORTH	C500 HVY BTM HDR	T	C	6	10	BL BH	7 7/8 7 1/4	43 1/2 43 1/2	C C	40 40	A A	C	265572
31	3/4	40	3 7/16	KENWORTH	C500	R	C	6	11	BL BL	7 7/8 7 1/4	43 1/2 43 1/2	C C	40 40	A A	C	226537
31	3/4	40	4 7/16	KENWORTH	C500	R	C	8	10	BL BL	7 7/8 7 1/4	43 1/2 43 1/2	C C	40 40	A A	C	226536
31	3/4	41 1/4	3 7/16	KENWORTH	K94	R	C	6	11	BL BL	7 5/16 7 5/16	43 1/2 43 1/2	C C	52 52	A A	CC	226539
32	3/4	28 1/2	2 1/4	KENWORTH	T400 X-3806, E-2655	VH	C	3	14	BL BL	7 3/8 7 3/8	32 1/8 32 1/8	2 1/2 2 1/2	40 40	A A	N	251000
32	3/4	28 1/2	3	KENWORTH	LOW FLOW 2 PASS CAN USE 284808 DIMPLED TUBE	VH	C	4	15	BL BL	7 3/8 7 3/8	32 1/8 32 1/8	C C	40 40	A A	N	251015
32	3/4	28 5/8	2 1/4	KENWORTH	USE 251015 DIMPLED TUBE	VTH	C	3	16	BL BL	7 3/8 7 3/8	32 1/8 32 1/8	C C	40 40	A A	N	253015
32	3/4	28 5/8	3	KENWORTH	USE 251015 DIMPLED TUBE	VTH	C	4	15	BL BL	7 3/8 7 3/8	32 1/8 32 1/8	C C	40 40	A A	N	252015
32	3/4	28 5/8	1 1/2	KENWORTH	SEE 251000	VTH	C	2	16	BL BL	7 3/8 7 3/8	32 1/8 32 1/8	2 1/2 2 1/2	40 40	A A	N	253000
32	3/4	28 5/8	2 1/4	KENWORTH	SEE 251000	VTH	C	3	14	BL BL	7 3/8 7 3/8	32 1/8 32 1/8	2 1/2 2 1/2	40 40	A A	N	252000
32	3/4	28 3/4	2 3/8	KENWORTH	T400 X-3806, E-2655	R	C	4	11	BL BL	7 3/8 7 3/8	32 1/8 32 1/8	2 1/2 2 1/2	40 40	A A	C	226891
32	3/4	28 3/4	2 7/8	KENWORTH	LOW FLOW 2 PASS CAN USE 284808 DIMPLED TUBE	R	C	5	11	BL BL	7 3/8 7 3/8	32 1/8 32 1/8	C C	40 40	A A	C	226004
32	3/4	28 3/4	2 7/8	KENWORTH	W900S	R	C	5	11	BL BL	7 3/8 7 3/8	32 1/8 32 1/8	2 1/2 2 1/2	40 40	A A	C	226101
32	3/4	29 1/16	2 1/4	KENWORTH	T-400 X-3806 ULTRA-FUSED CAN USE 251000	VH	C	3	16	BL BL	7 3/8 7 3/8	32 1/8 32 1/8	2 1/2 2 1/2	40 40	A A	N	284095
32	3/4	29 1/16	3	KENWORTH	W900S ULTRA-FUSED CAN USE 226101	VH	C	4	11	BL BL	7 5/16 7 5/16	32 1/8 32 1/8	2 1/2 2 1/2	40 40	A A	N	284519
32	3/4	29 1/16	3	KENWORTH	ULTRA-FUSED LOW FLOW TWO PASS CAN USE 251015 DIMPLED TUBE	VH	C	4	13	BL BL	7 5/16 7 5/16	32 1/8 32 1/8	C C	40 40	A A	N	284808
35	39 15/16	3	KENWORTH	1400, D-2245 HVY BTM HDR	T	C	4	10	BL BH	7 7/8 7 1/4	43 1/2 43 1/2	1 3/4 1 3/8	40 40	A A	C	265353	
35	39 15/16	4 1/2	KENWORTH	1400 HVY BTM HDR	T	C	6	9	BL BH	7 7/8 7 1/4	43 1/2 43 1/2	C C	40 40	A A	C	223242	
35	39 15/16	4 1/2	KENWORTH	K94, C-9 HVY BTM HDR	T	C	6	9	BL BH	7 7/8 7 1/4	43 1/2 43 1/2	C C	40 40	A A	C	271032	
35	40	2 3/8	KENWORTH	W900	R	C	4	10	BL BL	7 7/8 7 1/4	43 1/2 43 1/2	2 1/8 2 1/8	40 40	A A	C	226546	
35	40	2 7/8	KENWORTH	W900 HVY T/BTM HDRS	R	C	5	10	BH BH	7 7/8 7 1/4	43 1/2 43 1/2	2 13/16 2 13/16	40 40	A A	C	226547	
35	40	3 7/16	KENWORTH	W900 CONVENTIONAL	R	C	6	11	BL BL	7 7/8 7 1/4	43 1/2 43 1/2	C C	40 40	A A	C	226199	
35	40	3 7/16	KENWORTH	W900	R	C	6	10	BL BL	7 7/8 7 7/8	43 1/2 43 1/2	2 13/16 2 13/16	40 40	A A	C	226544	
35	40	4 7/16	KENWORTH	K94	R	C	8	8	BL BL	7 7/8 7 1/4	43 1/2 43 1/2	C C	40 40	A A	C	226543	
35	41	2 1/4	KENWORTH	K194-1871 CAN USE 226545	VH	C	3	16	BL BL	7 5/16 7 5/16	43 1/2 43 1/2	C C	52 52	A A	N	251137	

Vista-Pro Automotive - Core Catalog

(Cores Sorted by Application)

Height	Width	Depth	Application	Description	Fin Type	Fin Matl	Rows	FPI	BH/TH Type	BH/TH Width	BH/TH Length	BH/TH OHF	BH/TH Bolts	BH/TH Shape	Hdr Support	Part #
KENWORTH (Cont)																
35	41	3	KENWORTH		VH	C	4	16	BL BL	7 5/16 7 5/16	43 1/2 43 1/2	C C	52 52	A A	N	251138
35	41 1/16	3	KENWORTH	W-900 CONVENTIONAL ULTRA-FUSED CAN USE 226200	VH	C	4	16	BL BL	7 5/16 7 5/16	43 1/2 43 1/2	C C	52 52	A A	N	284085
35	41 1/4	2 1/4	KENWORTH		X	C	3	11	BL BL	7 5/16 7 5/16	43 1/2 43 1/2	C C	52 52	A A	CC	266392
35	41 1/4	2 3/8	KENWORTH	W900 CONVENTIONAL HVY BTM HDR	R	C	4	11	BL BH	7 5/16 7 5/16	43 1/2 43 1/2	C C	52 52	A A	CC	226545
35	41 1/4	3 7/16	KENWORTH	W900 KO94-79	R	C	6	11	BL BH	7 5/16 7 5/16	43 1/2 43 1/2	C C	52 52	A A	CC	226200
35 1/4	28 1/8	3 7/16	KENWORTH	KCJ	R	C	6	10	BL BL	6 3/8 6 3/8	30 3/4 30 3/4	C C	42 42	A A	C	226550
35 1/4	28 1/8	3 15/16	KENWORTH		R	C	7	8	BL BL	7 5/16 7 5/16	30 5/8 30 5/8	C C	38 38	A A	C	226552
39 1/4	29 13/16	4 1/2	KENWORTH	HVY BTM HDR 1ST TO 3RD HOLE 2 3/8"	T	C	6	9	BL BH	7 5/16 7 5/16	32 1/8 32 1/8	C C	42 42	A A	C	223307
39 1/4	30	2 3/8	KENWORTH	K100 COE, W900 CONVENTIONAL	R	C	4	11	BL BL	7 3/8 7 3/8	32 1/8 32 1/8	2 2	42 42	A A	C	226555
39 1/4	30	2 7/8	KENWORTH	923, 1400	R	C	5	11	BL BL	7 3/8 7 3/8	32 1/8 32 1/8	1 1/2 1 1/2	42 42	A A	C	226201
39 1/4	30	3 7/16	KENWORTH	K100 COE, W900 CONVENTIONAL	R	C	6	11	BL BL	7 3/8 7 3/8	32 1/8 32 1/8	C C	42 42	A A	C	226553
39 1/4	30	3 15/16	KENWORTH	923	R	C	7	11	BL BL	7 3/8 7 3/8	32 1/8 32 1/8	C C	42 42	A A	C	226556
39 1/4	30	4 7/16	KENWORTH	K923, 1200	R	C	8	9	BL BL	7 3/8 7 3/8	32 1/8 32 1/8	C C	42 42	A A	C	226554
40	28 1/2	2 1/4	KENWORTH	K100 LOW FLOW CAN USE 284055 DIMPLED TUBE	VH	C	3	15	BL BL	7 5/16 7 5/16	32 1/8 32 1/8	C C	40 40	A A	N	251040
40	28 1/2	2 1/4	KENWORTH	K100 W-900 T-600 ULTRA-FUSED E-2651 CAN USE 226143 OR 251002	VH	C	3	14	BL BL	7 3/8 7 3/8	32 1/8 32 1/8	2 1/2 2 1/2	40 40	A A	N	284080
40	28 1/2	2 1/4	KENWORTH	T400 E-2651	VH	C	3	14	BL BL	7 3/8 7 3/8	32 1/8 32 1/8	2 1/2 2 1/2	40 40	A A	N	251002
40	28 1/2	3	KENWORTH	K100E W900B T600A ULTRA-FUSED LOW FLOW CAN USE 251010 DIMPLED TUBE	VH	C	4	13	BL BL	7 5/16 7 5/16	32 1/8 32 1/8	C C	40 40	A A	N	284626
40	28 1/2	3	KENWORTH	K100E LOW FLOW CAN USE 284626 DIMPLED TUBE	VH	C	4	15	BL BL	7 5/16 7 5/16	32 1/8 32 1/8	C C	40 40	A A	N	251010
40	28 1/2	3	KENWORTH	CAN USE 226100	VH	C	4	14	BL BL	7 3/8 7 3/8	32 1/8 32 1/8	2 1/2 2 1/2	40 40	A A	N	251103
40	28 5/8	1 1/2	KENWORTH	SEE 251002	VTH	C	2	16	BL BL	7 3/8 7 3/8	32 1/8 32 1/8	2 1/2 2 1/2	40 40	A A	N	253002
40	28 5/8	2 1/4	KENWORTH	SEE 251040 DIMPLED TUBE	VTH	C	3	15	BL BL	7 5/16 7 5/16	32 1/8 32 1/8	C C	40 40	A A	N	252040
40	28 5/8	2 1/4	KENWORTH	SEE 251002	VTH	C	3	14	BL BL	7 3/8 7 3/8	32 1/8 32 1/8	2 1/2 2 1/2	40 40	A A	N	252002
40	28 5/8	2 1/4	KENWORTH	SEE 251103	VTH	C	3	14	BL BL	7 3/8 7 3/8	32 1/8 32 1/8	2 1/2 2 1/2	40 40	A A	N	253103
40	28 5/8	3	KENWORTH	SEE 251103	VTH	C	4	14	BL BL	7 3/8 7 3/8	32 1/8 32 1/8	2 1/2 2 1/2	40 40	A A	N	252103
40	28 3/4	2 3/8	KENWORTH	K100 LOW FLOW CAN USE 284055 DIMPLED TUBE	R	C	4	11	BL BL	7 5/16 7 5/16	32 1/8 32 1/8	C C	40 40	A A	C	226040
40	28 3/4	2 3/8	KENWORTH	K100, W900, T600 E-2614, E-2651	R	C	4	11	BL BL	7 5/16 7 5/16	32 1/8 32 1/8	C C	40 40	A A	C	226143

Vista-Pro Automotive - Core Catalog

(Cores Sorted by Application)

Height	Width	Depth	Application	Description	Fin Type	Fin Matl	Rows	FPI	BH/TH Type	BH/TH Width	BH/TH Length	BH/TH OHF	BH/TH Bolts	BH/TH Shape	Hdr Support	Part #
KENWORTH (Cont)																
40	28 3/4	2 7/8	KENWORTH	K100E LOW FLOW CAN USE 284626 DIMPLED TUBE	R	C	5	11	BL BL	7 5/16 7 5/16	32 1/8 32 1/8	C C	40 40	A A	C	226032
40	28 3/4	2 7/8	KENWORTH	T600A	R	C	5	11	BL BL	7 3/8 7 3/8	32 1/8 32 1/8	C C	40 40	A A	C	226100
40	28 3/4	2 7/8	KENWORTH	LOW FLOW, SHORT CLIP DIMPLED TUBE	R	C	5	11	BL BL	7 5/16 7 5/16	32 1/8 32 1/8	C C	40 40	A A	C	266032
40	28 3/4	3 7/16	KENWORTH		R	C	6	10	BL BL	7 5/16 7 5/16	32 1/8 32 1/8	C C	40 40	A A	C	226814
40	29 1/16	2 1/4	KENWORTH	K100E, W900B ULTRA-FUSED LOW FLOW CAN USE 251040 DIMPLED TUBE	VH	C	3	13	BL BL	7 5/16 7 5/16	32 1/8 32 1/8	C C	40 40	A A	N	284055
40	29 1/16	3	KENWORTH	ULTRA-FUSED CAN USE 251103	VH	C	4	13	BL BL	7 5/16 7 5/16	32 1/8 32 1/8	2 1/2 2 1/2	40 40	A A	N	284653
40	30	3 7/16	KENWORTH	KO94-105	R	C	6	11	BL BL	7 5/16 7 5/16	32 1/8 32 1/8	C C	40 40	A A	C	226557
40	33 3/4	2 3/8	KENWORTH	K100 K194-1375-1	R	C	4	11	BL BL	7 3/8 7 3/8	36 1/8 36 1/8	C C	44 44	A A	C	226558
40	33 3/4	3 7/16	KENWORTH	K100 COE	R	C	6	11	BL BL	7 3/8 7 3/8	36 1/8 36 1/8	C C	44 44	A A	C	226203
40	33 3/4	4 7/16	KENWORTH	K100 COE	R	C	8	11	BL BL	7 3/8 7 3/8	36 1/8 36 1/8	C C	46 46	A A	C	226559
40	28 3/4	2 7/8	KENWORTH		R	C	5	11	BL BL	7 3/8 7 3/8	32 1/8 32 1/8	2 3/8 2 3/8	40 40	A A	C	266100
KOEHRING																
34	35	4 7/16	KOEHRING	CRANE BRASS FINIS	Z	B	6	9	BL BL	7 1/2 7 1/2	38 38	C C	48 48	A A	C	282679
42	36 1/4	4 7/16	KOEHRING	BRASS FINIS END HOLES 2 3/16"	Z	B	6	9	BL BL	7 1/2 7 1/2	39 1/2 39 1/2	C C	50 50	A A	C	282720
KOHLER ENGINES																
14	13 1/2	2 1/4	KOHLER ENGINES & GEN	LIGHT GENERATOR L- 654	T	C	3	11	GR GR	4 1/8 4 1/8	14 1/4 14 1/4	1/4 1/4		A A	N	265652
14	13 3/4	2 3/8	KOHLER ENGINES & GEN	9 KW A-241346	S	C	4	11	GR GR	4 1/8 4 1/8	14 1/4 14 1/4	1/8 1/8		A A	N	229120
19 1/8	19 1/8	2 1/4	KOHLER ENGINES & GEN	T/HDR RD FRONT	T	C	3	7	SH SH	5 7/8 3 1/2	21 3/8 19 3/4	1 3/16 7/16		SP SP	N	260712
19 1/8	19 1/8	3	KOHLER ENGINES & GEN	T/HDR RD FRONT BRASS FINIS	T	B	4	7	SH GR	5 7/8 3 1/2	21 1/4 19 7/8	1 3/16 7/16		SP A	N	263118
23	23 1/8	1 3/4	KOHLER ENGINES & GEN	50-60 KW A-273412	S	C	3	10	GR GR	4 1/2 4 1/2	23 15/16 23 15/16	C C		A A	N	229122
27 1/2	25	2 7/8	KOHLER ENGINES & GEN	80-100 KW A-273472	S	C	5	9	GR GR	4 5/16 4 5/16	25 3/4 25 3/4	C C		A A	C	229123
28	27 1/2	2 7/8	KOHLER ENGINES & GEN	125-180 KW A-273433	S	C	5	11	GR GR	4 3/4 4 3/4	28 1/4 28 1/4	C C		A A	C	229124
29 9/16	27 1/2	3 15/16	KOHLER ENGINES & GEN	A-254428	S	C	7	9	GR GR	4 3/4 4 3/4	28 1/4 28 1/4	C C		A A	C	229125
30 1/4	30 5/8	3 15/16	KOHLER ENGINES & GEN	180 KW A-273927	S	C	7	10	GR GR	4 7/16 4 7/16	31 1/16 31 1/16	C C		A A	C	229126
KOMATSU																
15 3/4	17 1/16	2 5/8	KOMATSU		VT	C	4	13	GR GR	3 1/8 3 1/8	17 1/4 17 1/4	C C		A A	N	128823
26 5/8	25	3 11/16	KOMATSU	HVY STEEL FINIS	Z	S	5	9	GR GR	4 1/4 4 1/4	25 25	C C		A A	C	225934
31 1/2	31 1/2	4 1/2	KOMATSU	HVY T/BTM HDRS	T	C	6	7	BH BH	6 7/8 6 7/8	35 3/4 35 3/4	C C	36 36	A A	C	265664

Vista-Pro Automotive - Core Catalog

(Cores Sorted by Application)

Height	Width	Depth	Application	Description	Fin Type	Fin Matl	Rows	FPI	BH / TH Type	BH / TH Width	BH / TH Length	BH / TH OHF	BH / TH Bolts	BH / TH Shape	Hdr Support	Part #
KOMATSU (Cont)																
31 1/2	31 1/2	4 1/2	KOMATSU	HVY T/BTM HDRS BRASS FINS FACE DIPPED	B	B	6	7	BH BH	6 7/8 6 7/8	35 3/4 35 3/4	C C	36 36	A A	C	272521
32 3/8	33	4 1/2	KOMATSU	HVY T/BTM HDRS	B	C	6	7	BH BH	6 7/8 6 7/8	35 7/8 35 7/8	C C	38 38	A A	C	229579
33 1/4	30	4 7/16	KOMATSU	HVY T/BTM HDRS BRASS FINS	Z	B	6	7	BH BH	6 7/8 6 7/8	32 5/8 32 5/8	C C	36 36	B B	C	225635
33 1/4	30	4 7/16	KOMATSU	HVY T/BTM HDRS HVY STEEL FINS	Z	S	6	7	BH BH	6 7/8 6 7/8	32 5/8 32 5/8	C C	36 36	B B	C	225937
34 5/8	34 3/8	4 7/16	KOMATSU	350 BRASS FINS	Z	B	6	7	GR GR	5 1/8 5 1/8	35 35	3/8 3/8		A A	C	282579
39	34 3/8	2 15/16	KOMATSU	AC300 HVY STEEL FINS	Z	S	4	9	GR GR	5 5	34 3/4 34 3/4	3/16 3/16		A A	C	225951
40	27 1/2	5 3/16	KOMATSU	HVY T/BTM HDRS BRASS FINS	Z	B	7	8	BH BH	7 5/8 7 5/8	30 1/4 30 1/4	C C	32 32	A A	C	285151
41 1/8	40 1/2	5 1/4	KOMATSU	D-85 HVY T/BTM HDRS BRASS FINS FACE DIPPED	B	B	7	7	BH BH	7 9/16 7 9/16	44 1/8 44 1/8	C C	48 48	A A	CC	272523
45	30 1/2	4 1/2	KOMATSU	HVY T/BTM HDRS CORE OFFSET FOR O/C	B	C	6	7	BH BH	6 7/8 6 7/8	36 36	C C	38 38	A A	C	272910
45	30 5/8	4 7/16	KOMATSU	D-75 HVY T/BTM HDRS BRASS FINS CORE OFFSET FOR O/C	Z	B	6	9	BH BH	6 7/8 6 7/8	36 36	C C	38 38	A A	C	285150
45	44 3/8	5 3/16	KOMATSU	LOADER HVY T/BTM HDRS BRASS FINS	Z	B	7	9	BH BH	8 1/2 8 1/2	46 46	C C	60 60	A A	CC	285224
47 1/4	43 3/4	5 3/16	KOMATSU	D-155A 175-03-32260 HVY T/BTM HDRS BRASS FINS	Z	B	7	9	BH BH	8 1/4 8 1/4	46 3/4 46 3/4	C C	52 52	A A	CC	225621
47 1/4	43 3/4	5 3/16	KOMATSU	D-155A 175-03-32260 HVY T/BTM HDRS HVY STEEL FINS	Z	S	7	9	BH BH	8 1/4 8 1/4	46 3/4 46 3/4	C C	52 52	A A	CC	225925
47 1/4	44	5 1/4	KOMATSU	D-155 HVY T/BTM HDRS	B	C	7	7	BH BH	8 1/4 8 1/4	46 3/4 46 3/4	C C	52 52	A A	CC	229574
50 3/8	47 1/2	5 1/4	KOMATSU	D-355 HVY T/BTM HDRS SGL CTR MTG BAR	B	C	7	7	BH BH	8 1/4 8 1/4	49 1/2 49 1/2	C C	52 52	F F	CC	229557
62 1/4	55 1/2	5 1/4	KOMATSU	D-475 HVY T/BTM HDRS SGL CTR MTG BAR BRASS FINS FACE DIPPED	B	B	7	7	BH BH	8 1/8 8 1/8	55 7/8 55 7/8	C C	58 58	A A	F	272916
KUBOTA TRACTOR																
14 7/8	16 7/8	1 7/8	KUBOTA TRACTOR		X	C	2	11	GR GR	2 2	17 17	C C		A A	N	282714
16 3/4	19 3/8	2 7/8	KUBOTA TRACTOR		R	C	5	10	GR GR	3 1/4 3 1/4	19 3/4 19 3/4	C C		A A	N	226560
LeROI																
20 1/4	19 1/8	2 1/4	LeROI		T	C	3	7		6 3 1/2	20 20	1/4 1/4		0 0	N	260260
24	20	1 7/8	LeROI	COMPRESSOR	X	C	2	9	GR GR	3 1/4 3 1/4	21 3/8 21 3/8	3/16 3/16		A A	C	289175
LeTOURNEAU																
32 7/8	36 1/4	4 7/16	LeTOURNEAU	8V-71 DETROIT DIESEL HVY BTM HDR BRASS FINS	Z	B	6	9	BL BH	8 8	39 39	C C	46 46	A A	C	285215
43 7/8	36	4 1/2	LeTOURNEAU	12V-71 DETROIT DIESEL HVY T/BTM HDRS	T	C	6	6	BH BH	7 1/2 7 1/2	39 39	C C	46 46	A A	C	275021
43 7/8	36 1/4	4 5/8	LeTOURNEAU	HVY T/BTM HDRS	X	C	6	9	BH BH	8 8	39 39	C C	46 46	A A	C	266122
43 7/8	36 1/4	5 3/16	LeTOURNEAU	12V-71 DETROIT DIESEL HVY BTM HDR BRASS FINS	Z	B	7	9	BL BH	8 8	39 39	C C	46 46	A A	C	288805

Vista-Pro Automotive - Core Catalog

(Cores Sorted by Application)

Height	Width	Depth	Application	Description	Fin Type	Fin Matl	Rows	FPI	BH / TH Type	BH / TH Width	BH / TH Length	BH / TH OHF	BH / TH Bolts	BH / TH Shape	Hdr Support	Part #
LIFT TRUCKS & LOADERS																
10 5/8	16 5/16	3	LIFT TRUCKS & LOADERS	BAKER	T	C	4	7	GR	3 1/4	16 1/2	C		A	N	279488
									GR	3 1/4	16 1/2	C		A	N	279488
11 1/2	19 1/8	2 1/4	LIFT TRUCKS & LOADERS	DATSUN FG-103-P3	T	C	3	9	GR	3 3/4	19 3/8	3/16		A	N	279489
									GR	3 1/4	19 3/8	3/16		A	N	279489
11 1/2	19 3/8	2 1/4	LIFT TRUCKS & LOADERS	DATSUN FG-103-P3	X	C	3	9	GR	3 3/4	19 3/8	C		A	N	286472
									GR	3 1/4	19 3/8	C		A	N	286472
12 3/4	19 3/8	2 3/16	LIFT TRUCKS & LOADERS	TOYOTA LIFT	Z	C	3	7	GR	3	19 7/8	C		A	N	286623
									GR	2 3/4	19 7/8	C		A	N	286623
12 3/4	19 11/16	2 1/4	LIFT TRUCKS & LOADERS	YALE 31140644	T	C	3	9	GR	3	19 7/8	C		A	N	265521
									GR	2 3/4	19 7/8	C		A	N	265521
12 3/4	19 11/16	2 1/4	LIFT TRUCKS & LOADERS	TOYOTA LIFT	T	C	3	7	GR	3	19 7/8	C		A	N	279493
									GR	2 3/4	19 7/8	C		A	N	279493
13	15	4 7/16	LIFT TRUCKS & LOADERS	HYSTER BRASS FINS	Z	B	6	9	GR	6	15 3/4	C		A	N	281541
									GR	6	15 3/4	C		A	N	281541
13	15	5 3/16	LIFT TRUCKS & LOADERS	HYSTER BRASS FINS	Z	B	7	6	GR	6	15 7/8	C		A	N	225473
									GR	6	15 7/8	C		A	N	225473
13	15	5 1/4	LIFT TRUCKS & LOADERS	HYSTER	X	C	7	8	GR	6	15 7/8	C		A	N	221498
									GR	6	15 7/8	C		A	N	221498
13 1/8	15 5/8	5 3/16	LIFT TRUCKS & LOADERS	HYSTER BRASS FINS	Z	B	7	6	GR	6	15 7/8	C		A	N	225570
									GR	6	15 7/8	C		A	N	225570
13 1/8	19 3/8	2 1/4	LIFT TRUCKS & LOADERS	DATSUN LIFT	X	C	3	8	GR	3 1/4	19 1/4	C		A	N	282733
									GR	3 1/4	19 1/4	C		A	N	282733
13 1/2	14 3/8	2 15/16	LIFT TRUCKS & LOADERS	HYSTER 520A	Z	C	4	8	GR	3 1/2	15 3/4	C		A	N	288495
									GR	3 1/2	15 3/4	C		A	N	288495
13 1/2	15 3/16	3	LIFT TRUCKS & LOADERS	HYSTER	T	C	4	8	GR	3 1/2	15 3/4	1/4		A	N	223218
									GR	3 1/2	15 3/4	1/4		A	N	223218
13 3/4	17 1/2	2 7/8	LIFT TRUCKS & LOADERS	HYSTER H25E	S	C	5	7	GR	3 1/2	17 3/4	C		A	N	266132
									GR	3 1/2	17 3/4	C		A	N	266132
13 3/4	19 3/8	2 1/4	LIFT TRUCKS & LOADERS	TOYOTA LIFT	X	C	3	9	GR	2 7/8	19 3/4	3/16		A	N	286376
									GR	2 5/8	19 3/4	3/16		A	N	286376
13 7/8	15	2 1/4	LIFT TRUCKS & LOADERS	TCM FORK LIFT	X	C	3	8	GR	2 3/4	15 3/4	1/2		A	N	282787
									GR	2 3/4	15 3/4	1/2		A	N	282787
13 7/8	15 3/8	2	TCM FORK LIFT		VT	C	3	12	GR	2 3/4	15 3/4	1/2		A	N	122669
									GR	2 3/4	15 3/4	1/2		A	N	122669
13 7/8	17 1/2	2 15/16	LIFT TRUCKS & LOADERS	HYSTER	Z	C	4	11	GR	3 1/4	18 3/8	C		A	N	225474
									GR	3 1/4	18 3/8	C		A	N	225474
13 7/8	17 1/2	3	LIFT TRUCKS & LOADERS	TOWMOTOR	X	C	4	6	SQ	4	18	3/16		A	N	286781
									SQ	4	18	3/16		A	N	286781
14	17 5/8	2 5/8	LIFT TRUCKS & LOADERS		VT	C	4	16	GR	3 1/4	18 1/2	C		A	N	128735
									GR	3 1/4	18 1/2	C		A	N	128735
14 1/4	19 1/2	3	TOYOTA LIFT TRUCK		B	C	4	9	GR	3 1/4	19 7/8	C		A	N	225688
									GR	3 1/4	19 7/8	C		A	N	225688
14 1/4	19 13/16	2	TOYOTA LIFT TRUCK		VT	C	3	12	GR	2 3/4	19 7/8	C		A	N	122668
									GR	2 3/4	19 7/8	C		A	N	122668
14 3/8	19 1/4	2 5/8	TOYOTA LIFT TRUCK		VT	C	4	12	GR	3	19 5/8	C		A	N	122666
									GR	3	19 5/8	C		A	N	122666
14 1/2	19 1/8	2 1/4	LIFT TRUCKS & LOADERS	DATSUN FORKLIFT	T	C	3	8	GR	3 1/8	19 3/8	C		A	N	279505
									GR	3 1/8	19 3/8	C		A	N	279505
14 1/2	19 3/8	2 1/4	LIFT TRUCKS & LOADERS	DATSUN	X	C	3	8	GR	3 1/4	19 3/8	C		A	N	221791
									GR	3 1/4	19 3/8	C		A	N	221791
14 1/2	19 3/8	2 1/4	LIFT TRUCKS & LOADERS	TOYOTA LIFT	X	C	3	9	GR	3	19 3/4	3/16		A	N	289327
									GR	2 5/8	19 3/4	3/16		A	N	289327
14 1/2	19 3/8	2 1/4	LIFT TRUCKS & LOADERS	TOYOTA LIFT	X	C	3	11	GR	3	20	3/16		A	N	289933
									GR	3	20	3/16		A	N	289933

Vista-Pro Automotive - Core Catalog

(Cores Sorted by Application)

Height	Width	Depth	Application	Description	Fln Type	Fln Matl	Rows	FPI	BH/TH Type	BH/TH Width	BH/TH Length	BH/TH OHF	BH/TH Bolts	BH/TH Shape	Hdr Support	Part #
LIFT TRUCKS & LOADERS (Cont)																
14 1/2	19 11/16	2 1/4	LIFT TRUCKS & LOADERS	TOYOTA LIFT	T	C	3	9	GR	3	19 7/8	3/16		A	N	223258
									GR	2 5/8	19 7/8	C		A	N	223258
14 5/8	19 1/8	2 1/4	LIFT TRUCKS & LOADERS	DATSUN FG-105 P5	T	C	3	9	GR	3 3/4	19 3/8	C		A	N	279508
									GR	3 1/4	19 3/8	C		A	N	279508
14 5/8	19 1/8	3	LIFT TRUCKS & LOADERS	DATSUN FORKLIFT	T	C	4	7	GR	3 3/8	19 1/2	C		A	N	223216
									GR	3 3/8	19 1/2	C		A	N	223216
14 5/8	19 3/8	2 1/4	LIFT TRUCKS & LOADERS	DATSUN FG-105-P5	X	C	3	9	GR	3 3/4	19 3/8	C		A	N	286471
									GR	3 1/4	19 3/8	C		A	N	286471
14 3/4	16 1/4	3 3/4	LIFT TRUCKS & LOADERS	CATERPILLAR LIFT	X	C	5	9	GR	4 3/8	16 1/2	C		A	N	282707
									GR	4 3/8	16 1/2	C		A	N	282707
14 3/4	19 1/8	2 1/4	LIFT TRUCKS & LOADERS	DATSUN	T	C	3	9	GR	3 1/4	19 3/8	C		A	N	223217
									GR	3 1/4	19 3/8	C		A	N	223217
14 3/4	19 1/8	3	LIFT TRUCKS & LOADERS	DATSUN	T	C	4	9	GR	3 1/2	19 7/8	1/8		A	N	279511
									GR	3 1/2	19 7/8	1/8		A	N	279511
14 3/4	19 3/8	2 15/16	LIFT TRUCKS & LOADERS	DATSUN	Z	C	4	10	GR	3 1/2	19 7/8	3/16		A	N	286549
									GR	3 1/2	19 7/8	3/16		A	N	286549
14 3/4	19 3/8	3	LIFT TRUCKS & LOADERS	CLARK CY40B, CY50	X	C	4	9	GR	3	19 5/8	C		0	N	266083
									GR	3	19 5/8	C		0	N	266083
14 7/8	18 3/4	2 7/8	LIFT TRUCKS & LOADERS	CLARK ANGLED CRNRS	S	C	5	7	SH	3 1/16	19 5/8	C		SP	N	273812
									SH	3 1/16	19 5/8	C		SP	N	273812
14 7/8	19 3/8	2 7/8	LIFT TRUCKS & LOADERS	HYSTER	S	C	5	10		3	19 3/4	C		0	N	266004
										3	19 3/4	C		0	N	266004
14 7/8	19 3/8	2 15/16	LIFT TRUCKS & LOADERS	CLARK CF-Y50, CFY40B ANGLED CRNRS	Z	C	4	8	SH	3 1/8	19 3/4	C		SP	N	288418
									SH	3 1/8	19 3/4	C		SP	N	288418
14 7/8	20	2 1/4	LIFT TRUCKS & LOADERS	CLARK CF-Y50,CFY40B	X	C	3	9	GR	3 1/8	19 3/4	C		A	N	265458
									GR	3 1/8	19 3/4	C		A	N	265458
15	16 5/16	3	LIFT TRUCKS & LOADERS	CLARK	T	C	4	9	GR	3 3/8	17 13/16	C		A	N	261521
									GR	3 3/8	17 13/16	C		A	N	261521
15	16 7/8	1 7/8	LIFT TRUCKS & LOADERS	CLARK G82	X	C	2	8	GR	2 3/8	17 1/2	C		A	N	289889
									GR	2 3/8	17 1/2	C		A	N	289889
15	16 7/8	3	LIFT TRUCKS & LOADERS	HYSTER LIFT MODEL 40	X	C	4	9	GR	3 1/2	17 3/4	C		A	N	221852
									GR	3 1/2	17 3/4	C		A	N	221852
15	16 7/8	3	LIFT TRUCKS & LOADERS	HYSTER	T	C	4	10	GR	3 1/2	17 3/4	C		A	N	261523
									GR	3 1/2	17 3/4	C		A	N	261523
15	19 1/8	2 1/4	LIFT TRUCKS & LOADERS	HYSTER S50	T	C	3	9	GR	3 1/4	19 3/4	3/16		A	N	279512
									GR	3 1/4	19 3/4	3/16		A	N	279512
15	19 3/8	3	LIFT TRUCKS & LOADERS	CLARK ANGLED CRNRS	X	C	4	9	SQ	3	19 3/4	C		A	N	289037
									SQ	3	19 3/4	C		A	N	289037
15 1/8	19 3/8	3	LIFT TRUCKS & LOADERS	CLARK	X	C	4	7	GR	3 1/2	19 7/8	C		A	N	266003
									GR	3 1/2	19 7/8	C		A	N	266003
15 1/4	16 1/4	1 7/8	LIFT TRUCKS & LOADERS	CLARK C-20B	X	C	2	9	GR	2 1/4	17 3/8	C		A	N	288827
									GR	2 1/4	17 3/8	C		A	N	288827
15 1/4	19 1/8	3	LIFT TRUCKS & LOADERS	MOBILE LIFT	T	C	4	9	GR	3 3/8	19 3/4	C		A	N	279514
									GR	3 3/8	19 3/4	C		A	N	279514
15 1/4	19 3/8	2 1/4	LIFT TRUCKS & LOADERS	TOYOTA LIFT	X	C	3	8	GR	2 3/4	19 3/4	3/16		A	N	286637
									GR	2 3/4	19 3/4	3/16		A	N	286637
15 1/4	19 3/8	2 15/16	LIFT TRUCKS & LOADERS	MOBILE LIFT	Z	C	4	7	GR	3 3/8	19 3/4	C		A	N	286334
									GR	3 3/8	19 3/4	C		A	N	286334
15 1/4	19 11/16	2 1/4	LIFT TRUCKS & LOADERS	TOYOTA LIFT	T	C	3	8	GR	2 3/4	19 3/4	C		A	N	279515
									GR	2 3/4	19 3/4	C		A	N	279515
15 3/8	18 9/16	3	LIFT TRUCKS & LOADERS	CLARK, HYSTER	T	C	4	8	GR	3 7/16	19 7/8	1/8		A	N	223605
									GR	3 7/16	19 7/8	1/8		A	N	223605
15 3/8	19	3	LIFT TRUCKS & LOADERS	TOYOTA LIFT	B	C	4	6		3	19 5/8	C		0	N	229500
										3	19 5/8	C		0	N	229500

Vista-Pro Automotive - Core Catalog

(Cores Sorted by Application)

Height	Width	Depth	Application	Description	Fln Type	Fln Matl	Rows	FPI	BH/TH Type	BH/TH Width	BH/TH Length	BH/TH OHF	BH/TH Bolts	BH/TH Shape	Hdr Support	Part #
LIFT TRUCKS & LOADERS (Cont)																
15 3/8	19 3/8	2 15/16	LIFT TRUCKS & LOADERS	TOYOTA LIFT	Z	C	4	8	SQ	3 1/16	19 1/2	C		A	N	282652
									SQ	3 1/16	19 1/2	C		A	N	282652
15 3/8	19 11/16	2 1/4	LIFT TRUCKS & LOADERS	TOYOTA LIFT	T	C	3	9	GR	2 3/4	19 3/4	C		A	N	265602
									GR	2 3/4	19 3/4	C		A	N	265602
15 1/2	16 7/8	2 1/4	LIFT TRUCKS & LOADERS	C-20, C-20B	T	C	3	8	GR	3 3/8	17 3/4	1/8		A	N	274630
									GR	2 1/4	17 3/4	1/8		A	N	274630
15 1/2	18 3/4	2 3/16	LIFT TRUCKS & LOADERS	HYSTER	Z	C	3	10	SQ	3 1/2	19 3/4	3/16		A	N	288032
									SQ	3 1/2	19 3/4	3/16		A	N	288032
15 1/2	18 3/4	2 15/16	LIFT TRUCKS & LOADERS	HYSTER, CLARK	Z	C	4	9	GR	3 1/2	19 3/4	C		A	N	288030
									GR	3 1/2	19 3/4	C		A	N	288030
15 1/2	19 3/8	2 7/8	LIFT TRUCKS & LOADERS	HYSTER	S	C	5	6	GR	3 1/2	19 3/4	C		A	N	266135
									GR	3 1/2	19 3/4	C		A	N	266135
15 1/2	19 11/16	3	LIFT TRUCKS & LOADERS	HYSTER	T	C	4	8	GR	3 1/2	20	1/4		A	N	261527
									GR	3 1/2	20	1/4		A	N	261527
15 5/8	16 7/8	2 1/4	LIFT TRUCKS & LOADERS	TOYOTA LIFT	X	C	3	9	GR	3	17 1/4	C		A	N	221792
									GR	3	17 1/4	C		A	N	221792
15 5/8	17	3	LIFT TRUCKS & LOADERS	TOYOTA LIFT	B	C	4	6	GR	3	17 1/4	C		0	N	229653
									GR	3	17 1/4	C		0	N	229653
15 3/4	14 3/8	2 3/16	LIFT TRUCKS & LOADERS	TOWMOTOR 420	Z	C	3	10	GR	4 1/4	15 1/8	1/4		A	N	280444
									GR	3 1/4	15 1/8	1/4		A	N	280444
15 3/4	14 5/8	2 1/4	LIFT TRUCKS & LOADERS	CLARK	T	C	3	8	GR	4 1/2	15 1/4	1/8		A	N	276882
									GR	3 1/2	15 1/4	1/8		A	N	276882
15 3/4	15	2 15/16	LIFT TRUCKS & LOADERS	TOWMOTOR	Z	C	4	9	GR	4 3/8	15	3/16		A	N	289760
									GR	3 1/4	15	3/16		A	N	289760
15 3/4	16 1/4	2 15/16	LIFT TRUCKS & LOADERS	TOWMOTOR	Z	C	4	9	GR	3 3/4	16 5/8	3/16		A	N	289529
									GR	3 1/4	16 5/8	3/16		A	N	289529
15 3/4	16 1/4	3 3/4	LIFT TRUCKS & LOADERS	TOWMOTOR	X	C	5	7	SQ	5 1/8	16 5/8	3/16		A	N	286636
									SQ	5 1/8	16 5/8	3/16		A	N	286636
15 3/4	16 5/16	3	LIFT TRUCKS & LOADERS	TOWMOTOR	T	C	4	6	GR	4	16 1/2	1/4		A	N	223240
									GR	3 1/4	16 1/2	1/4		A	N	223240
15 3/4	16 5/16	3 3/4	LIFT TRUCKS & LOADERS	TOWMOTOR	T	C	5	7	GR	5 1/8	16 5/8	3/16		A	N	279520
									GR	5 1/8	16 5/8	3/16		A	N	279520
15 3/4	16 1/2	3	LIFT TRUCKS & LOADERS	TOWMOTOR	B	C	4	7	GR	4	16 1/2	1/8		A	N	277422
									GR	3 1/4	16 1/2	C		A	N	277422
15 3/4	16 7/8	2 1/4	LIFT TRUCKS & LOADERS	KOMATSU	X	C	3	8	GR	3 1/8	17 1/4	C		A	N	282799
									GR	3 1/8	17 1/4	C		A	N	282799
15 3/4	16 7/8	2 1/4	LIFT TRUCKS & LOADERS	MAZDA	X	C	3	8	GR	3	17	C		A	N	286901
									GR	3	17	C		A	N	286901
15 3/4	16 7/8	2 7/8	LIFT TRUCKS & LOADERS	KOMATSU	S	C	5	8	GR	3 1/8	17 1/4	C		A	N	229201
									GR	3 1/8	17 1/4	C		A	N	229201
15 3/4	16 7/8	2 15/16	LIFT TRUCKS & LOADERS	MUSTANG SKID LOADER	Z	C	4	11	GR	3 1/8	17 1/4	C		A	N	225520
									GR	3 1/8	17 1/4	C		A	N	225520
15 3/4	17	3	LIFT TRUCKS & LOADERS	TOYOTA LIFT	B	C	4	8	GR	3 1/8	17 1/4	C		A	N	229518
									GR	3 1/8	17 1/4	C		A	N	229518
15 3/4	17	3	LIFT TRUCKS & LOADERS		B	B	4	6	GR	3	17 1/4	C		A	N	229668
									GR	3	17 1/4	C		A	N	229668
15 3/4	17 1/16	2 5/8	LIFT TRUCKS & LOADERS		VT	C	4	12	GR	3	17 3/16	C		A	N	124955
									GR	3	17 3/16	C		A	N	124955
15 3/4	17 7/16	3	LIFT TRUCKS & LOADERS	HYSTER	T	C	4	8	GR	3 1/2	17 3/4	1/8		A	N	279522
									GR	3 1/2	17 3/4	1/8		A	N	279522
15 3/4	17 1/2	2 15/16	LIFT TRUCKS & LOADERS	TOWMOTOR	Z	C	4	9	GR	4	18	3/16		A	N	286885
									GR	4	18	3/16		A	N	286885
15 3/4	17 1/2	3	LIFT TRUCKS & LOADERS	HYSTER	X	C	4	8	GR	3 1/2	17 3/4	C		A	N	289974
									GR	3 1/2	17 3/4	C		A	N	289974

Vista-Pro Automotive - Core Catalog

(Cores Sorted by Application)

Height	Width	Depth	Application	Description	Fin Type	Fin Matl	Rows	FPI	BH / TH Type	BH / TH Width	BH / TH Length	BH / TH OHF	BH / TH Bolts	BH / TH Shape	Hdr Support	Part #
LIFT TRUCKS & LOADERS (Cont)																
15 3/4	17 1/2	4 7/16	LIFT TRUCKS & LOADERS	HYSTER 344816	S	C	8	7	GR	5 3/4	17 7/8	C		A	N	229130
									GR	5 3/4	17 7/8	C		A	N	
15 3/4	18	3	LIFT TRUCKS & LOADERS	HYSTER	T	C	4	8	GR	3 3/4	17 7/8	1/8		A	N	279519
									GR	3 3/4	17 7/8	1/8		A	N	
15 3/4	18 9/16	3	LIFT TRUCKS & LOADERS	CLARK 1672280	T	C	4	10	GR	3 3/8	19 7/8	C		A	N	264095
									GR	3 3/8	19 7/8	C		A	N	
15 3/4	18 3/4	3	LIFT TRUCKS & LOADERS	CLARK	X	C	4	8	GR	3 1/2	19 7/8	3/16		A	N	289048
									GR	3 1/2	19 7/8	3/16		A	N	
15 3/4	19 1/8	2 1/4	LIFT TRUCKS & LOADERS	CLARK	T	C	3	9	GR	3 1/2	19 3/4	3/16		A	N	279525
									GR	3 1/2	19 3/4	3/16		A	N	
15 3/4	19 3/8	2 1/4	LIFT TRUCKS & LOADERS	CLARK	X	C	3	9	GR	3 1/2	19 3/4	1		A	N	266190
									GR	3 1/2	19 3/4	1		A	N	
15 3/4	19 3/8	2 1/4	LIFT TRUCKS & LOADERS	TOYOTA LIFT	X	C	3	11	GR	3 1/8	19 3/4	C		A	N	286380
									GR	2 3/4	19 3/4	1/2		A	N	
15 3/4	19 3/8	2 1/4	LIFT TRUCKS & LOADERS	CLARK	X	C	3	10	GR	3 1/2	19 3/4	3/16		A	N	289890
									GR	3 1/2	19 3/4	3/16		A	N	
15 3/4	19 11/16	2 1/4	LIFT TRUCKS & LOADERS	TOYOTA LIFT	T	C	3	11	GR	3 1/8	19 3/4	C		A	N	279524
									GR	2 3/4	19 3/4	C		A	N	
15 3/4	19 11/16	3	LIFT TRUCKS & LOADERS	TOYOTA LIFT	T	C	4	9	GR	3 3/8	19 5/8	C		A	N	223608
									GR	3 3/8	19 5/8	C		A	N	
15 7/8	14 5/8	2 1/4	LIFT TRUCKS & LOADERS	TOWMOTOR LT40	T	C	3	8	GR	4 1/4	15	3/16		A	N	223259
									GR	3 1/4	15	3/16		A	N	
15 7/8	14 5/8	3	LIFT TRUCKS & LOADERS	TOWMOTOR	T	C	4	8	GR	4 1/4	15	1/4		A	N	260957
									GR	3 1/4	15	1/4		A	N	
15 7/8	16 1/4	3	LIFT TRUCKS & LOADERS	TOWMOTOR	X	C	4	7	GR	4	16 5/8	3/16		A	N	289759
									GR	3 1/4	16 5/8	C		A	N	
15 7/8	17 1/2	2 7/8	LIFT TRUCKS & LOADERS	HYSTER 261190	S	C	5	7	GR	3 7/16	17 3/4	C		A	N	229131
									GR	3 7/16	17 3/4	C		A	N	
15 7/8	18 9/16	3	LIFT TRUCKS & LOADERS	620 CLARK	T	C	4	9	GR	3 7/16	19 3/4	C		A	N	277197
									GR	3 7/16	19 3/4	C		A	N	
16	14 3/8	2 1/4	LIFT TRUCKS & LOADERS	CASE	X	C	3	8	GR	2 7/8	15	C		A	N	286860
									GR	2 7/8	15	C		A	N	
16	14 5/8	3	LIFT TRUCKS & LOADERS	CLARK	T	C	4	8	GR	4	15	C		A	N	279540
									GR	3 1/8	15	C		A	N	
16	16 1/4	2 15/16	LIFT TRUCKS & LOADERS	TOWMOTOR	Z	C	4	7	GR	4 1/2	16 1/2	3/16		A	N	289162
									GR	3 1/4	16 1/2	C		A	N	
16	16 5/16	3	LIFT TRUCKS & LOADERS	TOWMOTOR	T	C	4	7	GR	4 1/2	16 1/2	1/8		A	N	279533
									GR	3 1/4	16 1/2	C		A	N	
16	16 5/16	3	LIFT TRUCKS & LOADERS	TOWMOTOR	T	C	4	7	GR	4	16 1/2	1/8		A	N	279534
									GR	3 1/4	16 1/2	1/8		A	N	
16	16 5/16	3 3/4	LIFT TRUCKS & LOADERS	TOWMOTOR	T	C	5	8	GR	5	16 1/2	3/4		A	N	279536
									GR	5	16 1/2	3/4		A	N	
16	16 7/8	2 3/16	LIFT TRUCKS & LOADERS	YALE	Z	C	3	9	GR	3 1/2	17 7/8	3/16		A	N	286383
									GR	3 1/2	17 7/8	3/16		A	N	
16	16 7/8	2 3/16	LIFT TRUCKS & LOADERS	TOWMOTOR	Z	C	3	9	SQ	5 3/4	17 7/8	3/16		A	N	288123
									SQ	3 1/2	17 7/8	3/16		A	N	
16	16 7/8	2 15/16	LIFT TRUCKS & LOADERS	TOYOTA LIFT	Z	C	4	10	SQ	3	17 1/4	C		A	N	286381
									SQ	3	17 1/4	C		A	N	
16	16 7/8	3	LIFT TRUCKS & LOADERS	TOYOTA LIFT	T	C	4	9		3	17 1/4	C		0	N	279539
										3	17 1/4	C		0	N	
16	17 7/16	2 1/4	LIFT TRUCKS & LOADERS	TOWMOTOR	T	C	3	8	GR	4 1/8	18	C		A	N	279538
									GR	2 7/8	18	C		A	N	
16	17 7/16	3	LIFT TRUCKS & LOADERS	HYSTER	T	C	4	9	GR	3 7/8	17 7/8	C		A	N	279535
									GR	3 7/8	17 7/8	C		A	N	

Vista-Pro Automotive - Core Catalog

(Cores Sorted by Application)

Height	Width	Depth	Application	Description	Fln Type	Fln Matl	Rows	FPI	BH/TH Type	BH/TH Width	BH/TH Length	BH/TH OHF	BH/TH Bolts	BH/TH Shape	Hdr Support	Part #
16	17 1/2	2 1/4	LIFT TRUCKS & LOADERS	TOWMOTOR	X	C	3	8	GR GR	4 1/8 2 7/8	18 18	3/8 1/2		A A	N	286382
16	17 1/2	2 15/16	LIFT TRUCKS & LOADERS	HYSTER	Z	C	4	9	GR GR	3 7/8 3 7/8	17 7/8 17 7/8	1/4 1/4		A A	N	286576
16	22 1/2	3	LIFT TRUCKS & LOADERS	CLARK	T	C	4	8	GR GR	3 1/2 3 1/2	23 3/4 23 3/4	C C		A A	N	260764
16 1/8	16 1/4	2 15/16	LIFT TRUCKS & LOADERS	YALE	Z	C	4	10	GR SQ	6 1/4 3 1/8	16 1/4 16 1/4	3/16 C		A A	N	288224
16 1/8	16 1/4	3	LIFT TRUCKS & LOADERS	TOYOTA LIFT	X	C	4	9	GR GR	4 4	16 3/8 16 3/8	C C		A A	N	221793
16 1/8	16 5/16	3	LIFT TRUCKS & LOADERS	YALE	T	C	4	9	GR GR	6 1/4 3	16 1/4 16 1/4	3 5/16 C		A A	N	261538
16 1/8	16 5/16	3	LIFT TRUCKS & LOADERS	TOWMOTOR	T	C	4	6	GR GR	4 3 1/4	16 1/2 16 1/2	1/4 C		A A	N	265444
16 1/8	19 1/8	2 1/4	LIFT TRUCKS & LOADERS	CLARK	T	C	3	6	GR GR	3 3/8 3 3/8	19 3/4 19 3/4	C C		A A	N	279541
16 1/8	19 1/8	3	LIFT TRUCKS & LOADERS	YALE	T	C	4	9	GR GR	3 3/8 3 3/8	19 3/4 19 3/4	1/4 1/4		A A	N	279542
16 1/8	19 3/8	2 3/16	LIFT TRUCKS & LOADERS	CLARK C-25T	Z	C	3	7	GR GR	3 3/8 3 3/8	19 3/4 19 3/4	1/4 1/4		A A	N	286531
16 1/8	19 3/8	2 15/16	LIFT TRUCKS & LOADERS	YALE	Z	C	4	10	GR GR	3 3/8 3 3/8	19 3/4 19 3/4	1/4 1/4		A A	N	289049
16 1/4	14 1/16	3	LIFT TRUCKS & LOADERS	BAKER	T	C	4	6	GR GR	4 4	14 1/4 14 1/4	1/4 1/4		A A	N	264002
16 1/4	15 3/4	2 1/4	LIFT TRUCKS & LOADERS	BAKER	T	C	3	9	GR GR	4 3/8 2 3/8	15 3/4 15 3/4	C C		A A	N	279545
16 1/4	16	3	LIFT TRUCKS & LOADERS	BAKER	B	C	4	7	GR GR	4 4	16 1/2 16 1/2	C C		A A	N	272773
16 1/4	16 7/8	3	LIFT TRUCKS & LOADERS	ALLIS CHALMERS	T	C	4	8	GR GR	3 3/8 3 3/8	17 7/8 17 7/8	C C		A A	N	261541
16 1/4	17 7/16	2 1/4	LIFT TRUCKS & LOADERS	YALE	T	C	3	9	GR GR	3 3/8 3 3/8	17 3/4 17 3/4	1/8 1/8		A A	N	223246
16 1/4	17 1/2	2 3/8	LIFT TRUCKS & LOADERS	ALLIS CHALMERS LIFT	S	C	4	7	GR GR	3 3/8 3 3/8	17 7/8 17 7/8	1/4 1/4		A A	N	266256
16 1/4	19 3/8	2 1/4	LIFT TRUCKS & LOADERS	CLARK	X	C	3	10	GR GR	3 3	19 1/2 19 1/2	3/8 3/8		A A	N	281536
16 1/4	19 3/8	2 1/4	LIFT TRUCKS & LOADERS	YALE	X	C	3	9	GR GR	3 1/2 3 1/2	20 20	3/16 3/16		A A	N	288307
16 1/4	19 3/8	2 7/8	LIFT TRUCKS & LOADERS	MOBILE LIFT	S	C	5	7	GR GR	3 1/2 3 1/2	20 20	C C		A A	N	266156
16 3/8	16 7/8	3	LIFT TRUCKS & LOADERS	CLARK	X	C	4	7	GR GR	3 1/2 3 1/2	17 7/8 17 7/8	1/8 1/8		A A	N	266089
16 1/2	17 7/16	3	LIFT TRUCKS & LOADERS	ALLIS CHALMERS	T	C	4	8	GR GR	3 3/8 3 3/8	17 7/8 17 7/8	C C		A A	N	278596
16 1/2	17 7/16	3 3/4	LIFT TRUCKS & LOADERS	TOWMOTOR V60	T	C	5	7		3 7/8 3 7/8	17 7/8 17 7/8	C C		0 0	N	279551
16 1/2	17 1/2	2 3/16	LIFT TRUCKS & LOADERS	MUSTANG	Z	C	3	10	GR GR	4 4	18 18	3/16 3/16		A A	N	286945
16 1/2	17 1/2	2 1/4	LIFT TRUCKS & LOADERS	INTERNATIONAL	X	C	3	9	GR GR	2 1/2 2 1/2	17 3/4 17 3/4	C C		A A	N	286786
16 1/2	17 1/2	3	LIFT TRUCKS & LOADERS	ALLIS CHALMERS	X	C	4	9	GR GR	3 3/8 3 3/8	17 7/8 17 7/8	5/16 5/16		A A	N	289882
16 1/2	18 9/16	2 1/4	LIFT TRUCKS & LOADERS	INTERNATIONAL 3440	T	C	3	9	GR GR	2 1/2 2 1/2	19 19	C C		A A	N	223119

Vista-Pro Automotive - Core Catalog

(Cores Sorted by Application)

Height	Width	Depth	Application	Description	Fln Type	Fln Matl	Rows	FPI	BH/TH Type	BH/TH Width	BH/TH Length	BH/TH OHF	BH/TH Bolts	BH/TH Shape	Hdr Support	Part #
LIFT TRUCKS & LOADERS (Cont)																
16 1/2	18 3/4	2 3/16	LIFT TRUCKS & LOADERS	INTERNATIONAL 3400 HI-LIFT	Z	C	3	10	GR	2 1/2	19	C		A	N	225402
									GR	2 1/2	19	C		A	N	
16 1/2	23 1/16	3	LIFT TRUCKS & LOADERS	HYSTER	T	C	4	9	GR	3 1/4	23 1/2	C		A	N	279553
									GR	3 1/4	23 1/2	C		A	N	
16 5/8	17	3	LIFT TRUCKS & LOADERS	TOYOTA LIFT	B	C	4	6		3	17 1/4	C		0	N	229654
										3	17 1/4	C		0	N	
16 5/8	19 1/8	2 1/4	LIFT TRUCKS & LOADERS	YALE	T	C	3	8	GR	3 1/8	19 5/8	C		A	N	279554
									GR	3 1/8	19 5/8	C		A	N	
16 5/8	19 3/8	2 3/16	LIFT TRUCKS & LOADERS	YALE	Z	C	3	9	GR	3 1/8	19 5/8	C		A	N	289050
									GR	3 1/8	19 5/8	C		A	N	
16 5/8	19 3/8	2 15/16	LIFT TRUCKS & LOADERS	YALE	Z	C	4	9	FR	3 1/8	19 5/8	C		A	N	281664
									FR	3 1/8	19 5/8	C		A	N	
16 3/4	18	3 3/4	LIFT TRUCKS & LOADERS	CLARK	T	C	5	8	GR	4	18 3/4	C		A	N	261284
									GR	4	18 3/4	C		A	N	
16 3/4	19 1/8	3	LIFT TRUCKS & LOADERS	ALLIS CHALMERS	T	C	4	8	GR	3 3/8	19 3/4	C		A	N	223121
									GR	3 3/8	19 3/4	C		A	N	
16 7/8	18 1/8	4 7/16	LIFT TRUCKS & LOADERS	TOWMOTOR BRASS FINS	Z	B	6	9	GR	5 1/4	18 3/4	C		A	N	282665
									GR	5 1/4	18 3/4	C		A	N	
16 7/8	19 1/8	3	LIFT TRUCKS & LOADERS	CLARK 40B	T	C	4	8		3 1/8	19 3/4	C		0	N	262968
										3 1/8	19 3/4	C		0	N	
16 7/8	19 3/8	2 3/16	LIFT TRUCKS & LOADERS	TOWMOTOR	Z	C	3	7	GR	4	19 3/4	3/16		A	N	286907
									GR	4	19 3/4	3/16		A	N	
17	17 7/16	2 1/4	LIFT TRUCKS & LOADERS	ALLIS CHALMERS FTB34FS	T	C	3	8	GR	3 7/8	17 7/8	3/8		A	N	223264
									GR	3 7/8	17 7/8	3/8		A	N	
17	18 9/16	3	LIFT TRUCKS & LOADERS	CLARK ANGLED CRNRS FRONT	T	C	4	8	SH	3 1/4	20	1/4		SP	N	261403
									SH	3 1/4	20	1/4		SP	N	
17	18 3/4	3	LIFT TRUCKS & LOADERS	TOWMOTOR	X	C	4	8		3	19 3/4	C		0	N	266096
										3	19 3/4	C		0	N	
17	19 1/8	3	LIFT TRUCKS & LOADERS	CLARK ANGLED CRNRS	T	C	4	8	SQ	3	19 3/4	C		SP	N	223221
									SQ	3	19 3/4	C		SP	N	
17	19 1/8	3	LIFT TRUCKS & LOADERS	CLARK C30, C50, CF30	T	C	4	8	GR	3 3/8	20	C		A	N	223251
									GR	3 3/8	20	C		A	N	
17	19 3/8	2 1/4	LIFT TRUCKS & LOADERS	CLARK LOADER	X	C	3	11		3 1/8	19 3/4	3/8		0	N	287356
										3 1/8	19 3/4	3/8		0	N	
17	19 3/8	2 15/16	LIFT TRUCKS & LOADERS	CLARK LOADER ANGLED CRNRS	Z	C	4	9	SH	3 1/16	19 3/4	C		SP	N	225477
									SH	3 1/16	19 3/4	C		SP	N	
17	20 5/8	2 7/8	LIFT TRUCKS & LOADERS		S	C	5	9	GR	3 3/8	21 13/16	C		A	N	266127
									GR	3 3/8	21 13/16	C		A	N	
17	24 3/16	3	LIFT TRUCKS & LOADERS	CLARK FVC60	T	C	4	8	GR	3 1/2	25 3/4	C		A	N	223222
									GR	3 1/2	25 3/4	C		A	N	
17	24 3/8	3	LIFT TRUCKS & LOADERS	CLARK	X	C	4	9	GR	3 1/2	25 3/4	C		A	N	289629
									GR	3 1/2	25 3/4	C		A	N	
17 1/8	18 3/4	4 7/16	LIFT TRUCKS & LOADERS	TOWMOTOR BRASS FINS	Z	B	6	9	GR	5 1/4	18 7/8	C		A	N	286768
									GR	5 1/4	18 7/8	C		A	N	
17 1/8	19 1/8	2 5/8	TOYOTA LIFT TRUCK		VT	C	4	12	GR	3	19 1/2	C		A	N	124874
									GR	3	19 1/2	C		A	N	
17 1/8	19 3/8	3	LIFT TRUCKS & LOADERS	BAKER	X	C	4	6	GR	3 3/8	19 13/16	C		A	N	266205
									GR	3 3/8	19 13/16	C		A	N	
17 1/8	22 1/2	2 15/16	LIFT TRUCKS & LOADERS	HYSTER	Z	C	4	10	GR	3 1/2	23 3/4	C		A	N	289039
									GR	3 1/2	23 3/4	C		A	N	
17 1/8	22 1/2	3	LIFT TRUCKS & LOADERS	HYSTER H100C	T	C	4	10	GR	3 1/2	23 3/4	C		A	N	265754
									GR	3 1/2	23 3/4	C		A	N	
17 1/8	22 1/2	3	LIFT TRUCKS & LOADERS	HYSTER	T	C	4	9	GR	4	23 3/4	C		A	N	279564
									GR	4	23 3/4	C		A	N	

Vista-Pro Automotive - Core Catalog

(Cores Sorted by Application)

Height	Width	Depth	Application	Description	Fln Type	Fln Matl	Rows	FPI	BH/TH Type	BH/TH Width	BH/TH Length	BH/TH OHF	BH/TH Bolts	BH/TH Shape	Hdr Support	Part #
LIFT TRUCKS & LOADERS (Cont)																
17 1/4	15 3/16	3	LIFT TRUCKS & LOADERS	HYSTER VT75	T	C	4	7	GR GR	7 3/4 3	15 15	1/4 1/4		A A	N	262150
17 1/4	17 7/16	2 1/4	LIFT TRUCKS & LOADERS	ALLIS CHALMERS	T	C	3	8	GR GR	3 7/8 3 7/8	17 7/8 17 7/8	3/8 1/4		A A	N	278599
17 1/4	18 9/16	3	LIFT TRUCKS & LOADERS	TOWMOTOR	T	C	4	8	GR GR	4 1/8 4 1/8	18 7/8 18 7/8	C C		A A	N	270667
17 1/4	22 1/2	3	LIFT TRUCKS & LOADERS	HYSTER	T	C	4	8	GR GR	3 1/2 3 1/2	23 3/4 23 3/4	C C		A A	N	276912
17 3/8	17 7/16	3	LIFT TRUCKS & LOADERS	CLARK	T	C	4	8	GR GR	3 1/4 3 1/4	17 7/8 17 7/8	C C		A A	N	279568
17 3/8	17 1/2	2 15/16	LIFT TRUCKS & LOADERS	CLARK	Z	C	4	9	GR GR	3 1/4 3 1/4	17 7/8 17 7/8	C C		A A	N	289896
17 1/2	16 5/16	3	LIFT TRUCKS & LOADERS	TOWMOTOR	T	C	4	6	GR GR	3 1/2 3 1/2	16 1/2 16 1/2	1/8 1/8		A A	N	279573
17 1/2	18	3 3/4	LIFT TRUCKS & LOADERS	HYSTER	T	C	5	8		3 7/8 3 7/8	18 1/4 18 1/4	C C		0 0	N	279569
17 1/2	18 1/8	3 3/4	LIFT TRUCKS & LOADERS	HYSTER	X	C	5	8	GR GR	3 7/8 3 7/8	18 1/4 18 1/4	C C		A A	N	286635
17 5/8	16 7/8	2 1/4	LIFT TRUCKS & LOADERS	TCM LIFT	X	C	3	11	GR GR	3 3	17 1/4 17 1/4	C C		A A	N	221794
17 5/8	16 7/8	2 3/8	TOYOTA LIFT TRUCK		R	C	4	10	GR GR	3 3	17 1/4 17 1/4	C C		A A	N	225689
17 5/8	17	3	LIFT TRUCKS & LOADERS	TOYOTA LIFT	B	B	4	6	FR FR	3 3	17 1/4 17 1/4	C C		0 0	N	229651
17 5/8	20 5/8	3	LIFT TRUCKS & LOADERS	TOYOTA LIFT	X	C	4	6	GR GR	4 1/8 4 1/8	21 21	C C		A A	N	281868
17 3/4	15 5/8	2 3/16	LIFT TRUCKS & LOADERS	MINNEAPOLIS MOLINE	Z	C	3	7	GR GR	6 2 1/2	15 7/8 15 7/8	3/16 3/16		A A	N	281426
17 3/4	15 3/4	2 1/4	LIFT TRUCKS & LOADERS	MINNEAPOLIS MOLINE	T	C	3	6	GR GR	6 2 1/2	15 7/8 15 7/8	C C		A A	N	279576
17 3/4	17	3	LIFT TRUCKS & LOADERS		B	B	4	6	GR GR	3 3	17 1/4 17 1/4	C C		A A	N	229667
17 3/4	18	5 1/4	LIFT TRUCKS & LOADERS	HYSTER	T	C	7	9	GR GR	6 6	18 18	C C		A A	N	279578
17 3/4	18 1/8	3	LIFT TRUCKS & LOADERS	HYSTER	X	C	4	8	GR GR	4 1/4 4 1/4	18 3/4 18 3/4	1 1		A A	N	282796
17 3/4	18 1/8	4 7/16	LIFT TRUCKS & LOADERS	HYSTER BRASS FINS	Z	B	6	10	GR GR	6 6	18 18	C C		A A	N	286499
17 3/4	19 1/8	2 1/4	LIFT TRUCKS & LOADERS	YALE	T	C	3	8	GR GR	3 3	19 5/8 19 5/8	C C		A A	N	279575
17 3/4	19 1/8	2 1/4	LIFT TRUCKS & LOADERS	WHITING TRACK MOBILE	T	C	3	9	GR GR	2 1/2 2 1/2	19 3/8 19 3/8	C C		A A	N	279577
17 3/4	19 1/8	3	LIFT TRUCKS & LOADERS	ALLIS CHALMERS	T	C	4	6	GR GR	6 3 1/2	19 7/8 19 7/8	2 7/8 C		A A	N	223163
17 3/4	19 1/8	3	LIFT TRUCKS & LOADERS	BAKER	T	C	4	8	GR GR	4 3 3/8	20 20	1/4 1/4		A A	N	261606
17 3/4	19 1/4	2	LIFT TRUCKS & LOADERS		VT	C	3	12	GR GR	2 1/2 2 1/2	19 3/8 19 3/8	1/4 1/4		A A	N	124954
17 3/4	19 3/8	2 3/16	LIFT TRUCKS & LOADERS	WHITING TRACK MOBILE	Z	C	3	8	GR GR	2 1/2 2 1/2	19 3/8 19 3/8	C C		A A	N	225525
17 3/4	19 3/8	2 1/4	LIFT TRUCKS & LOADERS	YALE	X	C	3	8	GR GR	3 3	19 5/8 19 5/8	C C		A A	N	286618
17 3/4	20 3/8	2 5/8	MERCURY LIFT TRUCK		VT	C	4	12	GR GR	3 3	20 1/8 20 1/8	C C		A A	N	122010

Vista-Pro Automotive - Core Catalog

(Cores Sorted by Application)

Height	Width	Depth	Application	Description	Fin Type	Fin Matl	Rows	FPI	BH/TH Type	BH/TH Width	BH/TH Length	BH/TH OHF	BH/TH Bolts	BH/TH Shape	Hdr Support	Part #
LIFT TRUCKS & LOADERS (Cont)																
17 7/8	18 9/16	2 1/4	LIFT TRUCKS & LOADERS	TOWMOTOR	T	C	3	6	GR	5	18 1/2	C		A	N	279580
									GR	2 5/8	18 1/2	C		A	N	
17 7/8	23 1/16	3	LIFT TRUCKS & LOADERS	HYSTER	T	C	4	10	GR	3 1/2	23 3/4	1/4		A	N	261615
									GR	3 1/2	23 3/4	1/4		A	N	
18	17 7/16	2 1/4	LIFT TRUCKS & LOADERS	HYSTER	T	C	3	10	GR	3 1/2	17 3/4	C		A	N	263458
									GR	3 1/2	17 3/4	C		A	N	
18	17 1/2	5 3/16	LIFT TRUCKS & LOADERS	HYSTER BRASS FINS	Z	B	7	10	GR	6	18	C		A	N	286911
									GR	3	18	C		A	N	
18	19 1/8	2 1/4	LIFT TRUCKS & LOADERS	YALE	T	C	3	8	GR	3	19 5/8	3/16		A	N	279584
									GR	3	19 5/8	3/16		A	N	
18	19 1/8	3	LIFT TRUCKS & LOADERS	YALE	T	C	4	8	GR	3 3/8	19 7/8	C		A	N	279581
									GR	3 3/8	19 7/8	C		A	N	
18	19 3/8	2 1/4	LIFT TRUCKS & LOADERS	YALE	X	C	3	8	GR	3	19 5/8	3/16		A	N	289423
									GR	3	19 5/8	3/16		A	N	
18	19 3/8	2 15/16	LIFT TRUCKS & LOADERS	YALE	Z	C	4	10	GR	3	19 5/8	C		A	N	286619
									GR	3	19 5/8	C		A	N	
18	19 3/8	2 15/16	LIFT TRUCKS & LOADERS	YALE	Z	C	4	9	GR	3 3/8	19 7/8	3/16		A	N	289825
									GR	3 3/8	19 7/8	3/16		A	N	
18	19 3/8	3	LIFT TRUCKS & LOADERS	YALE	X	C	4	9	GR	3 3/8	19 7/8	C		A	N	266133
									GR	3 3/8	19 7/8	C		A	N	
18	19 11/16	2 1/4	LIFT TRUCKS & LOADERS	HYSTER	T	C	3	8	GR	3 1/4	19 7/8	1/4		A	N	260379
									GR	2 3/8	19 7/8	C		A	N	
18	23 1/16	3	LIFT TRUCKS & LOADERS	HYSTER	T	C	4	8	GR	3 7/16	23 3/4	1/8		A	N	273439
									GR	3 7/16	23 3/4	1/8		A	N	
18 1/8	18	3 3/4	LIFT TRUCKS & LOADERS	HYSTER	T	C	5	8	GR	4 1/4	18 3/4	C		A	N	265445
									GR	4 1/4	18 3/4	C		A	N	
18 1/8	22 1/2	3	LIFT TRUCKS & LOADERS	HYSTER	X	C	4	9	GR	3 1/2	23 5/8	1/4		A	N	265999
									GR	4 1/2	23 5/8	1/4		A	N	
18 1/8	22 1/2	3	LIFT TRUCKS & LOADERS	HYSTER	T	C	4	9	GR	3 1/4	23 5/8	1/4		A	N	279586
									GR	4 1/2	23 5/8	1/4		A	N	
18 1/4	18	3 3/4	LIFT TRUCKS & LOADERS	HYSTER	T	C	5	9	GR	4 1/4	18 3/4	C		A	N	279587
									GR	4 1/4	18 3/4	C		A	N	
18 1/4	19 3/8	2 1/4	LIFT TRUCKS & LOADERS	HYSTER	X	C	3	9		3 1/4	19 3/4	5/8		0	N	287529
										3 1/4	19 3/4	5/8		0	N	
18 1/2	18 1/8	3 3/4	LIFT TRUCKS & LOADERS	HYSTER H60F	X	C	5	9	GR	4 1/4	18 3/4	C		A	N	289972
									GR	4 1/4	18 3/4	C		A	N	
18 1/2	18 9/16	3 3/4	LIFT TRUCKS & LOADERS	HYSTER H60F	T	C	5	10	GR	4 1/4	18 3/4	C		A	N	279592
									GR	4 1/4	18 3/4	C		A	N	
18 1/2	19 1/8	3	LIFT TRUCKS & LOADERS	HYSTER	T	C	4	9	GR	4	19 3/4	C		A	N	279591
									GR	4	19 3/4	C		A	N	
18 1/2	20	2 3/8	LIFT TRUCKS & LOADERS	WHITE OH OPPOSITE SIDE	S	C	4	9	GR	3 1/2	20	1		A	N	273813
									GR	3 1/2	20	1		A	N	
18 5/8	17 1/2	1 3/4	LIFT TRUCKS & LOADERS	CLARK LOADER C/FLO	R	C	3	8	GR	3 1/4	17 7/8	C		A	N	226562
									GR	3 1/4	17 7/8	C		A	N	
18 5/8	18 3/4	2 7/8	LIFT TRUCKS & LOADERS	BAKER	S	C	5	8	GR	3 1/4	19 3/4	C		A	N	266159
									GR	3 1/4	19 3/4	C		A	N	
18 5/8	21 1/4	3	LIFT TRUCKS & LOADERS	CLARK C60	X	C	4	9	GR	3 1/2	21 7/8	C		A	N	289653
									GR	3 1/2	21 7/8	C		A	N	
18 5/8	21 3/8	3	LIFT TRUCKS & LOADERS	CLARK C60	T	C	4	9	GR	3 1/2	21 7/8	C		A	N	279593
									GR	3 1/2	21 7/8	C		A	N	
18 5/8	23 1/8	2 7/8	LIFT TRUCKS & LOADERS	CLARK	S	C	5	9	GR	4 1/2	24	1/8		A	N	266105
									GR	4 1/2	24	1/8		A	N	
18 3/4	17 1/2	2 3/16	LIFT TRUCKS & LOADERS	COTTON PICKER	Z	C	3	6	GR	3 1/4	17 7/8	3/16		A	N	225491
									GR	3 1/4	17 7/8	3/16		A	N	

Vista-Pro Automotive - Core Catalog

(Cores Sorted by Application)

Height	Width	Depth	Application	Description	Fin Type	Fin Matl	Rows	FPI	BH/TH Type	BH/TH Width	BH/TH Length	BH/TH OHF	BH/TH Bolts	BH/TH Shape	Hdr Support	Part #
LIFT TRUCKS & LOADERS (Cont)																
18 3/4	18 1/8	1 3/4	LIFT TRUCKS & LOADERS	CLARK	S	C	3	6	GR GR	3 1/8 3 1/8	18 18	3/16 3/16		A A	N	229008
18 3/4	18 1/8	3	LIFT TRUCKS & LOADERS	BAKER, HYSTER	X	C	4	9	GR GR	3 1/2 3 1/2	19 3/4 19 3/4	C C		A A	N	289041
18 3/4	19 1/8	2 1/4	LIFT TRUCKS & LOADERS	MINNEAPOLIS MOLINE	T	C	3	8	GR GR	3 1/2 3 1/2	19 3/4 19 3/4	1/4 1/4		A A	N	261634
18 3/4	19 3/8	2 3/16	LIFT TRUCKS & LOADERS	MINNEAPOLIS MOLINE	Z	C	3	9	GR GR	3 1/2 3 1/2	19 3/4 19 3/4	7/8 3/16		A A	N	288732
18 3/4	20	3 11/16	LIFT TRUCKS & LOADERS	HYSTER	Z	C	5	9	BL BL	6 3/8 6 3/8	22 22	C C	34 34	A A	C	282740
18 3/4	21 7/8	2 3/16	LIFT TRUCKS & LOADERS	CLARK	Z	C	3	10	GR GR	2 3/4 2 3/4	22 1/8 22 1/8	C C		A A	N	289897
18 3/4	21 7/8	2 1/4	LIFT TRUCKS & LOADERS	CLARK C500	X	C	3	8	GR GR	2 3/4 2 3/4	22 22	C C		A A	N	266209
18 7/8	19	3	TOYOTA LIFT TRUCK		B	C	4	9	GR GR	3 1/8 3 1/8	19 9/16 19 9/16	C C		A A	N	225691
19	18	3 3/4	LIFT TRUCKS & LOADERS	BAKER CF-600	T	C	5	8	GR GR	3 3/4 3 3/4	17 7/8 17 7/8	C C		A A	N	279602
19	18 1/8	2 15/16	LIFT TRUCKS & LOADERS	HYSTER	Z	C	4	9	GR GR	3 1/2 3 1/2	19 3/4 19 3/4	7/16 7/16		A A	N	289552
19	18 9/16	3	LIFT TRUCKS & LOADERS	HYSTER	T	C	4	7	GR GR	3 3/8 3 3/8	19 11/16 19 11/16	C C		A A	N	265360
19	19 1/8	3	LIFT TRUCKS & LOADERS	HYSTER	T	C	4	8	GR GR	3 1/2 3 1/2	19 3/4 19 3/4	C C		A A	N	279600
19	22 1/2	3	LIFT TRUCKS & LOADERS	TOWMOTOR	T	C	4	9	GR GR	3 3/8 3 3/8	23 5/8 23 5/8	C C		0 A	N	279603
19 1/8	18	3	TOYOTA LIFT TRUCK		B	C	4	9	GR GR	3 1/4 3 1/4	17 3/4 17 3/4	C C		A A	N	225692
19 1/8	20 5/8	2 1/4	LIFT TRUCKS & LOADERS	HOUGH	X	C	3	9	CR CR	7 1/4 4 1/2	17 3/4 21	3/8 3/4		A A	N	281659
19 1/4	17 7/16	3 3/4	LIFT TRUCKS & LOADERS	BAKER LIFT TRUCK	T	C	5	8	GR GR	4 4	18 18	C C		A A	N	265399
19 1/4	17 1/2	3	LIFT TRUCKS & LOADERS	BAKER	X	C	4	8	GR GR	4 4	18 18	3/16 3/16		A A	N	289270
19 1/4	18 1/8	2 7/8	LIFT TRUCKS & LOADERS	CLARK	S	C	5	8	GR GR	3 7/16 3 7/16	19 13/16 19 13/16	1/8 1/8		A A	N	229026
19 1/4	20 5/8	3	LIFT TRUCKS & LOADERS	CLARK 500	X	C	4	9	GR GR	3 1/2 3 1/2	21 7/8 21 7/8	C C		A A	N	289898
19 1/4	20 13/16	3	LIFT TRUCKS & LOADERS	CLARK 500	T	C	4	9	GR GR	3 1/2 3 1/2	21 7/8 21 7/8	1/8 1/8		A A	N	279615
19 1/4	22 1/2	2 1/4	LIFT TRUCKS & LOADERS	HYSTER	X	C	3	9	GR GR	3 1/2 3 1/2	23 3/4 23 3/4	C C		A A	N	289042
19 1/4	22 1/2	3	LIFT TRUCKS & LOADERS	HYSTER	T	C	4	10	GR GR	3 1/2 3 1/2	23 3/4 23 3/4	C C		A A	N	223116
19 3/8	16 7/8	4 7/16	LIFT TRUCKS & LOADERS	HYSTER BRASS FINS	Z	B	6	9	GR GR	6 6	18 18	3/16 3/16		A A	N	286516
19 3/8	16 7/8	5 1/4	LIFT TRUCKS & LOADERS	TOWMOTOR V60-C	X	C	7	6	GR GR	6 6	18 18	1/4 1/4		A A	N	266047
19 3/8	16 7/8	5 1/4	LIFT TRUCKS & LOADERS	HYSTER	T	C	7	7	GR GR	6 6	18 18	C C		A A	N	279620
19 3/8	18	2 1/4	LIFT TRUCKS & LOADERS	CLARK	T	C	3	8	GR GR	3 1/4 3 1/4	17 3/4 17 3/4	3/16 3/16		A A	N	279617
19 3/8	18 1/8	2 3/16	LIFT TRUCKS & LOADERS	CLARK	Z	C	3	9	GR GR	3 1/4 3 1/4	17 3/4 17 3/4	3/16 3/16		A A	N	289899

Vista-Pro Automotive - Core Catalog

(Cores Sorted by Application)

Height	Width	Depth	Application	Description	Fln Type	Fln Matl	Rows	FPI	BH/TH Type	BH/TH Width	BH/TH Length	BH/TH OHF	BH/TH Bolts	BH/TH Shape	Hdr Support	Part #
LIFT TRUCKS & LOADERS (Cont)																
19 3/8	18 1/8	2 15/16	LIFT TRUCKS & LOADERS	HYSTER	Z	C	4	9	GR	3 1/2	19 7/8	3/16		A	N	288021
									GR	3 1/2	19 7/8	3/16		A	N	288021
19 3/8	18 3/4	3	LIFT TRUCKS & LOADERS	HYSTER	X	C	4	8	GR	3 1/2	20	C		A	N	289936
									GR	3 1/2	20	C		A	N	289936
19 3/8	19 1/8	3	LIFT TRUCKS & LOADERS	HYSTER	T	C	4	8	GR	3 1/2	20	C		A	N	279618
									GR	3 1/2	20	C		A	N	279618
19 3/8	19 3/8	3	LIFT TRUCKS & LOADERS	TOYOTA LIFT	X	C	4	8	GR	3 1/2	19 3/4	C		A	N	286912
									GR	3 1/2	19 3/4	C		A	N	286912
19 3/8	20	3	LIFT TRUCKS & LOADERS	CLARK	X	C	4	9	GR	3 1/2	21 3/4	C		A	N	266428
									GR	3 1/2	21 3/4	C		A	N	266428
19 1/2	17 1/16	2 5/8	TOYOTA LIFT TRUCK		VT	C	4	12	GR	3	17 1/8	C		A	N	122009
									GR	3	17 1/8	C		A	N	122009
19 1/2	18	3	LIFT TRUCKS & LOADERS	HYSTER	T	C	4	9	GR	3 1/2	20	C		A	N	223239
									GR	3 1/2	20	C		A	N	223239
19 1/2	18	3	LIFT TRUCKS & LOADERS	SA-60, AX-60	T	C	4	8	GR	6 5/16	18	1/8		A	N	273473
									GR	3	18	C		A	N	273473
19 1/2	18 1/8	3 3/4	LIFT TRUCKS & LOADERS	HYSTER H40F	X	C	5	8	GR	4 1/4	18 3/4	3/16		A	N	289043
									GR	4 1/4	18 3/4	3/16		A	N	289043
19 1/2	18 9/16	2 1/4	LIFT TRUCKS & LOADERS	TOWMOTOR	T	C	3	10	GR	6	19 3/4	1/4		A	N	263093
									GR	3 1/4	19 3/4	1/4		A	N	263093
19 1/2	25 5/16	3 3/4	LIFT TRUCKS & LOADERS	CLARK CHY-100, C-120	T	C	5	9	GR	4 1/4	25 3/4	C		A	N	279623
									GR	4 1/4	25 3/4	C		A	N	279623
19 1/2	25 5/8	3 3/4	LIFT TRUCKS & LOADERS	CLARK CHY-100 C120	X	C	5	9	GR	4 1/4	25 3/4	C		A	N	289055
									GR	4 1/4	25 3/4	C		A	N	289055
19 5/8	16 7/8	2 1/4	LIFT TRUCKS & LOADERS	TOYOTA LIFT	X	C	3	8	GR	3	17 1/4	C		A	N	221855
									GR	3	17 1/4	C		A	N	221855
19 5/8	16 7/8	2 3/8	TOYOTA LIFT TRUCK		R	C	4	11	GR	3 1/8	17 1/4	C		A	N	225693
									GR	3 1/8	17 1/4	C		A	N	225693
19 5/8	17	2 1/4	LIFT TRUCKS & LOADERS	TOYOTA LIFT BRASS FINS	B	B	3	8	GR	3	17 1/8	C		A	N	229650
									GR	3	17 1/8	C		A	N	229650
19 5/8	17	3	LIFT TRUCKS & LOADERS	TOYOTA LIFT	B	C	4	7	FR	3 1/8	17 1/4	C		A	N	229527
									FR	3 1/8	17 1/4	C		A	N	229527
19 5/8	17	3	LIFT TRUCKS & LOADERS	TOYOTA LIFT	B	C	4	6	FR	3	17 1/4	C		0	N	229656
									FR	3	17 1/4	C		0	N	229656
19 5/8	17 1/16	2 5/8	TOYOTA LIFT TRUCK		VT	C	4	12	GR	3 1/8	17 1/4	C		A	N	122712
									GR	3 1/8	17 1/4	FF		A	N	122712
19 5/8	17 1/2	3	LIFT TRUCKS & LOADERS	CLARK C500	X	C	4	6	GR	3 1/4	18	C		A	N	289169
									GR	3 1/4	18	C		A	N	289169
19 5/8	18	2 1/4	LIFT TRUCKS & LOADERS	CLARK C500 C/FLO	T	C	3	8	GR	3 1/4	18	C		A	N	223225
									GR	3 1/4	18	C		A	N	223225
19 5/8	18 1/8	2 3/16	LIFT TRUCKS & LOADERS	CLARK C500	Z	C	3	9	GR	3 1/4	18	3/16		A	N	225486
									GR	3 1/4	18	3/16		A	N	225486
19 5/8	19 1/8	2 1/4	LIFT TRUCKS & LOADERS	CLARK	T	C	3	9	GR	4 1/4	19 5/8	FF		A	N	279626
									GR	4 1/4	19 5/8	FF		A	N	279626
19 5/8	19 1/8	3	LIFT TRUCKS & LOADERS	CLARK A630B	T	C	4	8	FR	3 1/8	19 5/8	C		0	N	279625
									FR	3 1/8	19 5/8	C		0	N	279625
19 5/8	19 3/8	2 3/16	LIFT TRUCKS & LOADERS	CLARK	Z	C	3	10	GR	4 1/4	19 5/8	3/16		A	N	289269
									GR	4 1/4	19 5/8	3/16		A	N	289269
19 5/8	19 3/8	2 15/16	LIFT TRUCKS & LOADERS	CLARK A630B	Z	C	4	9	SQ	3 1/8	19 5/8	3/16		A	N	289054
									SQ	3 1/8	19 5/8	3/16		A	N	289054
19 5/8	20 5/8	2 1/4	LIFT TRUCKS & LOADERS	CASE LOADER 1842U	X	C	3	7	GR	4	21 3/4	1 1/2		A	N	289921
									GR	4	21 3/4	1 1/2		A	N	289921
19 3/4	18	3	LIFT TRUCKS & LOADERS	CLARK C500, C/FLO.	B	C	4	8	GR	3 3/8	17 7/8	1/8		A	N	277402
									GR	3 3/8	17 7/8	1/8		A	N	277402

Vista-Pro Automotive - Core Catalog

(Cores Sorted by Application)

Height	Width	Depth	Application	Description	Fln Type	Fln Matl	Rows	FPI	BH/TH Type	BH/TH Width	BH/TH Length	BH/TH OHF	BH/TH Bolts	BH/TH Shape	Hdr Support	Part #
LIFT TRUCKS & LOADERS (Cont)																
19 3/4	18 1/8	3 3/4	LIFT TRUCKS & LOADERS	HYSTER H60F	X	C	5	9	GR GR	4 1/4 4 1/4	18 3/4 18 3/4	C C		A A	N	265996
19 3/4	18 1/8	3 3/4	LIFT TRUCKS & LOADERS	CATERPILLAR LIFT	X	C	5	7	GR GR	5 1/4 5 1/4	18 3/4 18 3/4	C C		A A	N	282761
19 3/4	19 1/8	2 1/4	LIFT TRUCKS & LOADERS	HOUGH 25B LOADER	T	C	3	6	GR GR	4 4	19 3/4 19 3/4	FF FF		A A	N	279632
19 3/4	19 3/8	2 1/4	LIFT TRUCKS & LOADERS	HOUGH 25-B LOADER	X	C	3	6	GR GR	4 4	19 3/4 19 3/4	3/16 3/16		A A	N	221823
19 3/4	21 7/8	2 15/16	LIFT TRUCKS & LOADERS	YALE	Z	C	4	6	SQ SQ	3 3	22 22	C C		A A	N	282776
19 3/4	24 3/16	3 3/4	LIFT TRUCKS & LOADERS	TROJAN M134	T	C	5	9	GR GR	4 4	24 24	C C		A A	N	263229
19 7/8	19 3/8	3	LIFT TRUCKS & LOADERS	ROSS CARRIER	X	C	4	7	GR GR	3 3/8 3 3/8	19 3/4 19 3/4	1/4 1/4		A A	N	266246
20	13 1/2	3	LIFT TRUCKS & LOADERS	TOWMOTOR	T	C	4	9	GR GR	3 1/8 3 1/8	14 14	C C		A A	N	279634
20	13 3/4	2 15/16	LIFT TRUCKS & LOADERS	TOWMOTOR	Z	C	4	11	SQ SQ	3 1/8 3 1/8	14 14	C C		A A	N	286580
20	18	2 1/4	LIFT TRUCKS & LOADERS	CLARK	T	C	3	9	GR GR	5 7/8 3 1/2	19 3/4 19 3/4	1/4 1/4		A A	N	260119
20 1/8	19 11/16	3	LIFT TRUCKS & LOADERS	HYSTER	T	C	4	9	GR GR	4 4	19 7/8 19 7/8	C C		A A	N	279635
20 1/8	20	2 15/16	LIFT TRUCKS & LOADERS	HYSTER	Z	C	4	11	GR GR	4 4	19 7/8 19 7/8	3/16 3/16		A A	N	289937
20 1/8	22 1/2	2 7/8	LIFT TRUCKS & LOADERS	HYSTER	S	C	5	8	GR GR	3 3/8 4 1/4	23 3/4 23 3/4	C 1/4		A A	N	229007
20 1/4	26 1/4	4 7/16	LIFT TRUCKS & LOADERS	TAYLOR BRASS FINS	Z	B	6	10	GR GR	5 5	27 27	C C		A A	N	286948
20 3/8	18 3/4	2 1/4	LIFT TRUCKS & LOADERS	CLARK	X	C	3	8	GR GR	5 7/8 3 7/16	19 3/4 19 3/4	1/4 1/4		A A	N	266390
20 1/2	20 13/16	3	LIFT TRUCKS & LOADERS	CLARK 1500, C120	T	C	4	9	GR GR	6 3 1/2	22 22	1/4 1/4		A A	N	223223
20 3/4	20 1/4	3	LIFT TRUCKS & LOADERS	CLARK	T	C	4	9	GR GR	3 5/8 3 5/8	22 22	1/4 1/4		A A	N	261712
20 3/4	20 5/8	2 1/4	LIFT TRUCKS & LOADERS	ROSS CARRIER	X	C	3	11	SQ SQ	3 1/2 3 1/2	21 21	3/16 3/16		A A	N	287777
20 3/4	21 1/4	3	LIFT TRUCKS & LOADERS	INTERNATIONAL	X	C	4	10	GR GR	3 1/2 3 1/2	21 3/4 21 3/4	3/16 3/16		A A	N	286598
21	17 1/2	2 15/16	LIFT TRUCKS & LOADERS	ROSS CARRIER	Z	C	4	9	GR GR	3 1/2 3 1/2	17 7/8 17 7/8	1/4 1/4		A A	N	288538
21	19 1/8	3	LIFT TRUCKS & LOADERS	BOBCAT	T	C	4	8	GR GR	3 3/8 3 3/8	20 20	1/4 1/4		A A	N	261724
21	20 5/8	2 1/4	LIFT TRUCKS & LOADERS	PAYLOADER	X	C	3	11	GR GR	3 1/2 3 1/2	22 22	3/16 3/16		A A	N	288777
21	20 5/8	2 15/16	LIFT TRUCKS & LOADERS	PAYLOADER	Z	C	4	9	SQ SQ	3 1/2 3 1/2	22 22	3/16 3/16		A A	N	287702
21	21 1/4	2 15/16	LIFT TRUCKS & LOADERS	CLARK BL60	Z	C	4	10	GR GR	3 3/8 3 3/8	21 7/8 21 7/8	C C		A A	N	289904
21	21 1/4	3	LIFT TRUCKS & LOADERS	CLARK	X	C	4	9	GR GR	3 3/8 3 3/8	21 3/4 21 3/4	C C		A A	N	266183
21	21 3/8	3	LIFT TRUCKS & LOADERS	CLARK	T	C	4	9	GR GR	3 3/8 3 3/8	21 7/8 21 7/8	C C		A A	N	279649
21	23 1/8	3 11/16	LIFT TRUCKS & LOADERS	INTERNATIONAL	Z	C	5	10	GR GR	4 1/4 4 1/4	23 3/4 23 3/4	3/16 3/16		A A	N	286600

Vista-Pro Automotive - Core Catalog

(Cores Sorted by Application)

Height	Width	Depth	Application	Description	Fln Type	Fln Matl	Rows	FPI	BH/TH Type	BH/TH Width	BH/TH Length	BH/TH OHF	BH/TH Bolts	BH/TH Shape	Hdr Support	Part #
LIFT TRUCKS & LOADERS (Cont)																
21 1/8	19 3/8	3	LIFT TRUCKS & LOADERS	BOBCAT	X	C	4	8	GR	3 7/8	19 3/4	3/16		A	N	286727
									GR	3 7/8	19 3/4	3/16		A	N	286727
21 1/4	22 1/2	2 7/8	LIFT TRUCKS & LOADERS	HYSTER	S	C	5	9	GR	3 1/2	23 3/4	C		A	N	266223
									GR	3 1/2	23 3/4	C		A	N	266223
21 1/4	22 1/2	2 15/16	LIFT TRUCKS & LOADERS	HYSTER	Z	C	4	9	SQ	3 1/2	23 3/4	C		A	N	282744
									SQ	3 1/2	23 3/4	C		A	N	282744
21 1/4	24 3/16	3	LIFT TRUCKS & LOADERS	CASE W-14 LOADER	T	C	4	9	GR	4 3/4	25 3/8	3/16		A	N	265905
									GR	4 3/4	25 3/8	3/16		A	N	265905
21 3/4	18 1/8	2 15/16	LIFT TRUCKS & LOADERS	CLARK LOADER	Z	C	4	10	SQ	6	19 3/8	3/16		A	N	287494
									SQ	3 1/8	19 3/8	1/8		A	N	287494
21 3/4	19 3/8	2 1/4	LIFT TRUCKS & LOADERS	CLARK	X	C	3	8	GR	3 1/2	19 3/4	3/16		A	N	282455
									GR	3 1/2	19 3/4	3/16		A	N	282455
21 3/4	25	2 15/16	LIFT TRUCKS & LOADERS	CLARK 160B	Z	C	4	11	GR	4	26	3/16		A	N	289439
									GR	4	26	3/16		A	N	289439
21 3/4	26 1/4	2 15/16	LIFT TRUCKS & LOADERS	CLARK	Z	C	4	11	GR	4	26 7/8	3/16		A	N	282591
									GR	4	26 7/8	3/16		A	N	282591
21 7/8	19 3/8	3	LIFT TRUCKS & LOADERS	HYSTER	X	C	4	10	GR	4	19 3/4	C		A	N	266043
									GR	4	19 3/4	C		A	N	266043
21 7/8	19 3/8	3 3/4	LIFT TRUCKS & LOADERS	HYSTER	X	C	5	11	GR	4	19 3/4	C		A	N	266216
									GR	4	19 3/4	C		A	N	266216
22	19 11/16	3	LIFT TRUCKS & LOADERS	CONTINENTAL LIFT	T	C	4	9	GR	3 1/4	19 3/4	C		A	N	279657
									GR	3 1/4	19 3/4	C		A	N	279657
22 3/8	23 1/8	3	LIFT TRUCKS & LOADERS	CLARK	X	C	4	9	GR	3 1/2	23 3/4	3/16		A	N	286950
									GR	3 1/2	23 3/4	3/16		A	N	286950
22 1/2	23 5/8	3	LIFT TRUCKS & LOADERS	TROJAN	T	C	4	9	GR	4	24	1/4		A	N	261762
									GR	4	24	1/4		A	N	261762
23	19 11/16	3	LIFT TRUCKS & LOADERS	CLARK	T	C	4	8	GR	3 7/8	19 7/8	3/16		A	N	279663
									GR	3 7/8	19 7/8	3/16		A	N	279663
23	25	3 11/16	LIFT TRUCKS & LOADERS	CLARK	Z	C	5	9	GR	4 1/4	25 3/4	C		A	N	289122
									GR	4 1/4	25 3/4	C		A	N	289122
23	25	4 7/16	LIFT TRUCKS & LOADERS	SKIDDER BRASS FINS	Z	B	6	6		4 3/4	26	C	0	N	289906	
										4 3/4	26	C	0	N	289906	
23 1/2	20 5/8	2 15/16	LIFT TRUCKS & LOADERS	PAYLOADER	Z	C	4	9	SQ	4	21 3/4	3/16		A	N	288040
									SQ	4	21 3/4	3/16		A	N	288040
24	23 5/8	3 3/4	LIFT TRUCKS & LOADERS	TROJAN	T	C	5	8	GR	4	24	C		A	C	279675
									GR	4	24	C		A	C	279675
24	24 3/4	3	LIFT TRUCKS & LOADERS	HOUGH PAYLOADER	T	C	4	8	GR	4 3/4	25 1/2	1/8		A	C	279672
									GR	4 3/4	25 1/2	1/8		A	C	279672
24 1/4	24 3/4	3 3/4	LIFT TRUCKS & LOADERS	CLARK	T	C	5	9	GR	4 3/4	26	1/8		A	C	279676
									GR	4 1/4	26	1/8		A	C	279676
24 3/8	24 3/4	3 3/4	LIFT TRUCKS & LOADERS	LOADER	T	C	5	9	GR	4 3/4	25 1/2	C		A	C	279677
									GR	4 3/4	25 1/2	C		A	C	279677
24 3/4	11 1/4	3 11/16	LIFT TRUCKS & LOADERS	METRO BOB CAT	Z	C	5	6	GR	4 1/4	12	C		A	C	282667
									GR	4 1/4	12	C		A	C	282667
24 7/8	24 3/4	3 3/4	LIFT TRUCKS & LOADERS	BAKER	T	C	5	9	GR	4 5/8	25 1/2	C		A	C	261840
									GR	4 5/8	25 1/2	C		A	C	261840
25 1/8	25 5/16	2 1/4	LIFT TRUCKS & LOADERS	WAGNER	T	C	3	8	GR	3 7/8	25 3/4	1/8		A	C	279681
									GR	3 7/8	25 3/4	1/8		A	C	279681
25 1/4	25	2 15/16	LIFT TRUCKS & LOADERS	HUSKY LIFT	Z	C	4	10	GR	4	25 7/8	3/16		A	C	286871
									GR	4	25 7/8	3/16		A	C	286871
25 1/4	25 5/16	3	LIFT TRUCKS & LOADERS	HUSKY LIFT	T	C	4	10	GR	4	25 7/8	3/16		A	C	266382
									GR	4	25 7/8	3/16		A	C	266382
25 1/4	26 1/4	2 1/4	LIFT TRUCKS & LOADERS	TOWMOTOR	X	C	3	9	GR	4	27	C		A	C	286397
									GR	4	27	C		A	C	286397

Vista-Pro Automotive - Core Catalog

(Cores Sorted by Application)

Height	Width	Depth	Application	Description	Fin Type	Fin Matl	Rows	FPI	BH/TH Type	BH/TH Width	BH/TH Length	BH/TH OHF	BH/TH Bolts	BH/TH Shape	Hdr Support	Part #
LIFT TRUCKS & LOADERS (Cont)																
25 3/4	22 1/2	3 3/4	LIFT TRUCKS & LOADERS	MICHIGAN	T	C	5	9	GR	4 1/2	23 1/8	C		A	C	261857
									GR	4 1/2	23 1/8	C		A	C	288681
25 3/4	22 1/2	3 3/4	LIFT TRUCKS & LOADERS	MICHIGAN	X	C	5	8	GR	4 1/2	23 1/8	3/16		A	C	288681
									GR	4 1/2	23 1/8	3/16		A	C	288681
25 3/4	27 1/2	3 11/16	LIFT TRUCKS & LOADERS	YALE	Z	C	5	10	BL	7 3/8	30	1 7/8	40	A	C	281666
									BL	7 3/8	30	1 7/8	40	A	C	281666
26	24 3/8	3 11/16	LIFT TRUCKS & LOADERS	MICHIGAN 85A	Z	C	5	8	GR	6 1/8	25 1/4	3/16		A	C	282692
									GR	4 1/2	24 3/4	3/16		A	C	282692
26	28 1/8	2 1/4	LIFT TRUCKS & LOADERS	HOUGH	X	C	3	11	BL	6 3/8	31 1/8	1 5/16	36	F	C	289977
									BL	6 3/8	31 1/8	1 5/16	36	F	C	289977
26 1/8	23 1/8	4 7/16	LIFT TRUCKS & LOADERS	TROJAN BRASS FINS	Z	B	6	7	BL	7 5/8	26 1/8	1 3/4	36	A	C	289592
									BL	7 5/8	26 1/8	1 3/4	36	A	C	289592
26 1/4	23 1/8	4 7/16	LIFT TRUCKS & LOADERS	TROJAN TRACTOR BRASS FINS	Z	B	6	10	BL	7 5/8	26 1/4	C	40	A	C	282597
									BL	7 5/8	26 1/4	C	40	A	C	282597
26 3/8	22 1/2	2 1/4	LIFT TRUCKS & LOADERS	MICHIGAN	X	C	3	8	GR	4 1/2	23 1/4	1/4		A	C	287398
									GR	4 1/8	23 1/4	1/4		A	C	287398
27	35	3 3/4	LIFT TRUCKS & LOADERS	HYSTER	X	C	5	11	BL	7 1/2	37	C	48	A	C	281678
									BL	7 1/2	37	C	48	A	C	281678
27 3/8	24	6	LIFT TRUCKS & LOADERS	CLARK SKIDDER 1913288, 1923035 HVY T/BTM HDRS BRASS FINS FACE DIPPED	B	B	8	6	BH	8 7/8	26 7/8	C	40	A	C	279691
									BH	8 7/8	26 7/8	C	40	A	C	279691
27 5/8	25	2 15/16	LIFT TRUCKS & LOADERS	HOUGH	Z	C	4	9	SQ	4 5/8	26	1		A	C	286586
									SQ	4 5/8	26	1		A	C	286586
27 5/8	25	5 3/16	LIFT TRUCKS & LOADERS	CLARK SKIDDER BRASS FINS	Z	B	7	6	SQ	6	26 1/2	C		A	C	289910
									SQ	6	26 1/2	C		A	C	289910
28 3/8	26 1/4	4 7/16	LIFT TRUCKS & LOADERS	MICHIGAN BRASS FINS	Z	B	6	8	GR	6 1/8	27 1/2	1/2		A	C	282770
									GR	5 1/2	27 1/2	1/2		A	C	282770
28 3/4	25	3 3/4	LIFT TRUCKS & LOADERS	CLARK SKIDDER HVY T/BTM HDRS BRASS FINS FACE DIPPED	B	B	5	6	BH	6 3/4	26 3/4	C	32	A	C	272514
									BH	6 3/4	26 3/4	C	32	A	C	272514
29 1/2	28 1/8	4 7/16	LIFT TRUCKS & LOADERS	HOUGH H-65 BRASS FINS	Z	B	6	7	GR	5 7/8	28 3/4	C		A	C	289975
									GR	5 7/8	28 3/4	C		A	C	289975
29 1/2	28 1/8	4 1/2	LIFT TRUCKS & LOADERS	HOUGH H65	T	C	6	8	GR	5 7/8	28 3/4	C		A	C	279705
									GR	5 7/8	28 3/4	C		A	C	279705
29 1/2	29 3/8	5 3/16	LIFT TRUCKS & LOADERS	MICHIGAN BRASS FINS	Z	B	7	9	GR	6 1/8	30 3/4	C		A	C	286952
									GR	6 1/8	30 3/4	C		A	C	286952
29 3/4	29 13/16	3 3/4	LIFT TRUCKS & LOADERS	MICHIGAN HVY T/BTM HDRS BRASS FINS	T	B	5	9	BH	7	32	1 1/2	44	A	C	265610
									BH	7	32	1 1/2	44	A	C	265610
29 3/4	30	3 11/16	LIFT TRUCKS & LOADERS	CLARK HVY BTM HDR	Z	C	5	10	BL	7	32	1 1/2	44	A	C	286702
									BH	7	32	1 1/2	44	A	C	286702
30 1/4	11 1/2	3 3/4	LIFT TRUCKS & LOADERS	BOBCAT LOADER	B	C	5	7	GR	4 5/16	12 1/16	C		A	C	229519
									GR	4 5/16	12 1/16	C		A	C	229519
33	31 1/4	3 11/16	LIFT TRUCKS & LOADERS	HOUGH PAYLOADER	Z	C	5	10	BL	6 7/8	34	1 1/2	42	A	C	289006
									BL	6 7/8	34	1 1/2	42	A	C	289006
35 1/2	28	6	LIFT TRUCKS & LOADERS	CLARK HVY T/BTM HDRS BRASS FINS FACE DIPPED	B	B	8	6	BH	8 3/4	30 3/4	C	44	A	C	272474
									BH	8 3/4	30 3/4	C	44	A	C	272474
36 1/8	31 1/2	3 3/4	LIFT TRUCKS & LOADERS	HOUGH HVY BTM HDR	T	C	5	8	BL	8 5/8	34	C	44	A	C	279718
									BH	8 5/8	34	C	44	A	C	279718
37	34 5/16	4 1/2	LIFT TRUCKS & LOADERS	CLARK HVY BTM HDR	T	C	6	9	BL	8 1/4	36 1/2	C	46	A	C	272821
									BH	8 1/4	36 1/2	C	46	A	C	272821
37 1/2	37 11/16	5 1/4	LIFT TRUCKS & LOADERS	TROJAN HVY T/BTM HDRS	T	C	7	9	BH	8 1/4	40	C	50	A	C	279721
									BH	8 1/4	40	C	50	A	C	279721
39 1/4	22 1/2	6	LIFT TRUCKS & LOADERS	HOUGH 550 LOADER HVY BTM HDR	T	C	8	9	BL	9 1/4	22 7/8	C	36	A	C	223588
									BH	9 1/4	22 7/8	C	36	A	C	223588

Vista-Pro Automotive - Core Catalog

(Cores Sorted by Application)

Height	Width	Depth	Application	Description	Fin Type	Fin Matl	Rows	FPI	BH / TH Type	BH / TH Width	BH / TH Length	BH / TH OHF	BH / TH Bolts	BH / TH Shape	Hdr Support	Part #
LIFT TRUCKS & LOADERS (Cont)																
40	32 1/2	5 3/16	LIFT TRUCKS & LOADERS	MICHIGAN HVY T/BTM HDRS BRASS FINS	Z	B	7	8	BH BH	9 1/8 7 7/8	36 36	C C	48 48	A A	C	289777
40	32 5/8	4 1/2	LIFT TRUCKS & LOADERS	MICHIGAN 275A HVY T/BTM HDRS	T	C	6	8	BH BH	9 1/4 7 7/8	36 36	C C	48 48	A A	C	275234
41 1/2	36	5 1/4	LIFT TRUCKS & LOADERS	MICHIGAN HVY T/BTM HDRS	T	C	7	8	BH BH	9 1/4 8 1/4	40 40	C C	52 52	A A	C	279722
45 3/8	43 3/4	5 3/16	LIFT TRUCKS & LOADERS	HOUGH 560 E-2525 HVY T/BTM HDRS BRASS FINS	Z	B	7	9	BH BH	8 3/8 8 3/8	46 1/4 46 1/4	C C	58 58	A A	CC	282726
46	32 1/16	5 1/4	LIFT TRUCKS & LOADERS	MICHIGAN HVY T/BTM HDRS	T	C	7	9	BH BH	9 1/8 7 7/8	36 36	C C	48 48	A A	C	266584
48 1/2	36 7/8	5 3/16	LIFT TRUCKS & LOADERS	MICHIGAN HVY T/BTM HDRS BRASS FINS	Z	B	7	9	BH BH	9 1/4 8 1/4	40 40	C C	52 52	A A	CC	282709
59	55 5/8	5 3/16	LIFT TRUCKS & LOADERS	MICHIGAN HVY T/BTM HDRS BRASS FINS	Z	B	7	9	BH BH	10 1/4 10 1/4	58 3/4 58 3/4	C C	72 72	A A	CC	286342
LIMA CRANES																
27 3/8	28 3/4	3 3/4	LIMA	CRANE	X	C	5	9	BL BL	7 1/2 7 1/4	32 3/4 32 3/4	1 5/16 1 5/16	44 44	A A	C	289756
LINCOLN																
24 1/2	18 1/8	2	LINCOLN		VT	C	3	12	GR GR	3 7/16 2 7/8	18 7/8 18 7/8	3/4 3/4		A A	N	122579
25	19 1/4	2	LINCOLN		VT	C	3	14	GR GR	2 7/8 2 7/8	19 19	C C		A A	N	122512
25 3/4	17 5/8	2	LINCOLN		VT	C	3	12	GR GR	2 5/8 2 5/8	17 1/2 17 1/2	C C		A A	N	122406
LINCOLN ELECTRIC																
16 3/4	19 3/8	1 7/8	LINCOLN ELECTRIC		X	C	2	7	GR GR	3 2 1/4	19 5/8 19 5/8	1/4 1/4		A A	N	281530
16 3/4	19 11/16	1 1/2	LINCOLN ELECTRIC		T	C	2	8	GR GR	3 2 1/4	19 5/8 19 5/8	3/16 3/16		A A	N	272723
19	19 3/8	2 3/16	LINCOLN ELECTRIC	CONTINENTAL ENGINE	Z	C	3	10	GR FR	3 1/8 2 5/16	19 5/8 19 5/8	3/16 C		A A	N	287559
19	19 13/16	1 1/4	LINCOLN ELECTRIC		VT	C	2	12	GR GR	3 1/8 2 3/8	19 5/8 19 5/8	3/8 3/8		A A	N	124890
19	20	1 7/8	LINCOLN ELECTRIC	200 AMP	X	C	2	8	GR GR	3 3/8 2 3/8	19 5/8 19 5/8	3/8 1/4		A A	N	221271
19 3/4	19 11/16	2 1/4	LINCOLN ELECTRIC	S-6090	T	C	3	8	GR GR	6 3 1/2	19 3/4 19 3/4	1/8 1/8		A A	N	271140
19 7/8	19 1/8	2 1/4	LINCOLN ELECTRIC	LINCOLN WELDER	T	C	3	8	GR GR	4 4	19 3/4 19 3/4	1/4 1/4		A A	N	223172
20 1/4	19 3/8	2 1/4	LINCOLN ELECTRIC		X	C	3	9	GR FR	3 1/8 2 1/4	19 5/8 19 5/8	C C		A A	N	266044
20 1/2	18 9/16	2 1/4	LINCOLN ELECTRIC		T	C	3	8	GR GR	6 4 1/4	20 20	1/8 1/8		A A	N	279733
20 7/8	22 1/2	3	LINCOLN ELECTRIC	300	T	C	4	9	GR GR	6 4 1/4	23 3/4 23 3/4	1/8 1/8		A A	N	270594
21 3/8	19 3/8	2 3/16	LINCOLN ELECTRIC	DIX 40-250 AMP	Z	C	3	10	GR GR	3 1/8 2 3/8	19 3/4 19 3/4	3/16 3/16		A A	N	287742
21 3/8	19 11/16	2 1/4	LINCOLN ELECTRIC	250-300 AMP	T	C	3	9	GR FR	3 1/8 2 1/4	19 3/4 19 3/4	1/8 C		A A	N	274436
21 3/8	19 13/16	1 1/4	LINCOLN ELECTRIC	WELDER	VT	C	2	12	GR GR	3 3/8 2 3/8	19 5/8 19 5/8	3/8 C		A A	N	124958

Vista-Pro Automotive - Core Catalog

(Cores Sorted by Application)

Height	Width	Depth	Application	Description	Fin Type	Fin Matl	Rows	FPI	BH/TH Type	BH/TH Width	BH/TH Length	BH/TH OHF	BH/TH Bolts	BH/TH Shape	Hdr Support	Part #
LINK BELT																
35	29 3/8	4 7/16	LINK-BELT	BRASS FINS	Z	B	6	9	GR GR	4 7/8 4 7/8	29 3/4 29 3/4	C C		A A	C	282696
49 3/4	43 3/4	5 3/16	LINK-BELT	HVY T/BTM HDRS BRASS FINS	Z	B	7	10	BH BH	8 1/4 8 1/4	47 47	C C	58 58	A A	CC	282482
LORAIN SHOVEL																
29 3/4	28 11/16	3 3/4	LORAIN SHOVEL		T	C	5	9	BL BL	7 1/2 7 1/2	30 3/4 30 3/4	1 5/16 1 5/16	42 42	A A	C	272926
LUFKIN																
18 1/2	18 9/16	3	LUFKIN	HB333	T	C	4	8	GR GR	4 3/4 3	19 3/4 19 3/4	1/8 C		A A	N	275482
MACK TRUCKS																
25 1/4	21 7/8	2 7/8	MACK TRUCKS	MIDLINER MS-2000	R	C	5	11	GR GR	3 5/16 3 5/16	22 5/16 22 5/16	C C		A A	C	226565
25 1/4	22 5/16	2 1/4	MACK TRUCKS		VE	C	4	14	GR GR	3 5/16 3 5/16	22 5/16 22 5/16	C C		A A	N	128765
26 1/4	20 5/8	2 7/8	MACK TRUCKS		R	C	5	10	GR GR	8 3 15/16	21 1/8 21 1/8	13/16 13/16		A A	C	226566
26 1/2	21 3/8	3	MACK TRUCKS	B61	T	C	4	10	GR GR	6 3 3/8	21 3/4 21 3/4	1/4 1/4		A A	C	261291
26 3/4	20 5/8	2 3/8	MACK TRUCKS	MB-401	R	C	4	9	GR GR	8 3/8 3 5/8	21 1/2 21 1/2	3/8 3/8		A A	C	226567
27	20 5/8	2 3/8	MACK TRUCKS	B61	R	C	4	9	GR GR	8 3 5/8	21 1/8 21 1/8	3/16 3/16		A A	C	226569
27	20 5/8	2 3/8	MACK TRUCKS	B SERIES X-947-3E X-971-1E	R	C	4	9	GR GR	8 3/8 3 5/8	21 1/2 21 1/2	1/4 1/4		A A	C	226571
27	20 13/16	3	MACK TRUCKS	B61	T	C	4	9	GR GR	8 3/8 3 5/8	21 1/2 21 1/2	1/4 1/4		A A	C	261987
27	20 13/16	3	MACK TRUCKS		T	C	4	9	GR GR	6 7/8 3 5/8	21 3/4 21 3/4	3/8 C		A A	C	261994
27	21 1/4	2 7/8	MACK TRUCKS	B61	R	C	5	9	GR GR	8 3 5/8	21 1/4 21 1/4	3/16 3/16		A A	C	226206
27	21 1/4	2 7/8	MACK TRUCKS	B61	R	C	5	10	GR GR	8 3/8 3 5/8	21 1/2 21 1/2	1/8 1/8		A A	C	226570
28 1/2	23 3/4	2 3/8	MACK TRUCKS		R	C	4	11		6 7/8 3 5/8	24 1/4 24 1/4	1/4 1/4		0 0	C	226572
28 1/2	23 3/4	2 7/8	MACK TRUCKS	X-1631, X-1071-2	R	C	5	11	GR GR	6 7/8 3 5/8	24 1/4 24 1/4	3/8 3/8		A A	C	226574
28 7/8	23 5/8	3	MACK TRUCKS	B60	T	C	4	9	GR GR	6 7/8 3 5/8	24 1/4 24 1/4	1/4 1/4		A A	C	262004
28 7/8	23 3/4	2 3/8	MACK TRUCKS	B60 X-973-C, C1	R	C	4	9	GR GR	6 7/8 3 5/8	24 1/4 24 1/4	1/4 1/4		A A	C	226575
28 7/8	23 3/4	2 7/8	MACK TRUCKS		R	C	5	9	GR GR	6 7/8 3 5/8	24 1/4 24 1/4	1/4 1/4		A A	C	226576
28 7/8	24 3/16	3	MACK TRUCKS		T	C	4	11	GR GR	6 7/8 3 5/8	24 1/4 24 1/4	3/16 3/16		A A	C	275230
29	34 5/16	2 1/4	MACK TRUCKS	R MODEL HVY BTM HDR	T	C	3	10	BL BH	6 6	37 1/8 37 1/8	C C	44 44	A A	C	265657
29	34 5/16	3	MACK TRUCKS	R MODEL HVY BTM HDR	T	C	4	10	BL BH	6 6	37 1/8 37 1/8	C C	44 44	A A	C	223226
29	34 3/8	1 3/4	MACK TRUCKS	E-1919 E-2416	R	C	3	11	BL BL	6 1/4 6 1/4	36 3/8 36 3/8	2 2	46 46	A A	C	226163
29	34 3/8	2 3/8	MACK TRUCKS	R MODEL E-2416-1	R	C	4	11	BL BL	6 1/4 6 1/4	36 3/8 36 3/8	C C	46 46	A A	C	226154

Vista-Pro Automotive - Core Catalog

(Cores Sorted by Application)

Height	Width	Depth	Application	Description	Fin Type	Fin Matl	Rows	FPI	BH / TH Type	BH / TH Width	BH / TH Length	BH / TH OHF	BH / TH Bolts	BH / TH Shape	Hdr Support	Part #
29	34 3/8	2 3/8	MACK TRUCKS	R MODEL 3MF-5224AP1, E-1610-1, 3MF-5296APZ HVY BTM HDR	R	C	4	8	BL	6	37 1/8	1 1/2	44	A	C	226207
									BH	6	37 1/8	1 1/2	44	A		
29	34 3/8	2 3/8	MACK TRUCKS	E-1440-4 HVY BTM HDR	R	C	4	11	BL	6 7/8	37 1/8	C	44	A	C	226209
29	34 3/8	2 3/8	MACK TRUCKS	R MODEL E-1758-2, X-2339-6	R	C	4	11	BL	6 7/8	37 1/8	C	44	A	C	226579
									BL	6	37 1/8	C	44	A		
29	34 3/8	2 3/8	MACK TRUCKS	R MODEL ULTRA-FUSED CAN USE 226207	R	C	4	11	BL	6	37 1/8	1 1/2	44	A	C	281938
									BL	6	37 1/8	1 1/2	44	A		
29	34 3/8	2 7/8	MACK TRUCKS	E-2416-9	R	C	5	11	BL	6 1/4	36 3/8	C	46	A	C	226167
									BL	6 1/4	36 3/8	C	46	A		
29	34 3/8	2 7/8	MACK TRUCKS	R MODEL E-1322 HVY BTM HDR	R	C	5	9	BL	6	37 1/8	C	44	A	C	226210
									BH	6	37 1/8	C	44	A		
29	34 3/8	2 7/8	MACK TRUCKS	R MODEL E-1440-1, E1440-5 HVY BTM HDR	R	C	5	11	BL	6 7/8	37 1/8	C	44	A	C	226211
									BH	6 7/8	37 1/8	C	44	A		
29	34 3/8	3 7/16	MACK TRUCKS	R MODEL E-1611 HVY BTM HDR	R	C	6	11	BL	6	37 1/8	C	44	A	C	226212
									BH	6	37 1/8	C	44	A		
29	34 3/8	3 7/16	MACK TRUCKS	WESTERN HVY BTM HDR	R	C	6	11	BL	6 7/8	37 1/8	C	44	A	C	226580
									BH	6 7/8	37 1/8	C	44	A		
29	34 3/8	3 7/16	MACK TRUCKS		R	C	6	11	BL	6 7/8	37 1/8	C	44	A	C	226581
									BL	6	37 1/8	C	44	A		
29	34 1/2	2 1/4	MACK TRUCKS	E-2416-12	VH	C	3	16	BL	6 1/4	36 3/8	C	46	A	N	251141
									BL	6 1/4	36 3/8	C	46	A		
29	34 1/2	2 1/4	MACK TRUCKS	R MODEL	VH	C	3	14	BL	6	37 1/8	1 1/2	44	A	N	251110
									BL	6	37 1/8	1 1/2	44	A		
29	34 1/2	3	MACK TRUCKS	E-2416-1	VH	C	4	14	BL	6 1/4	36 3/8	C	46	A	N	251128
									BL	6 1/4	36 3/8	C	46	A		
29	34 1/2	1 1/2	MACK TRUCKS	SEE 251110	VTH	C	2	16	BL	6	37 1/8	1 1/2	44	A	N	253110
									BL	6	37 1/8	1 1/2	44	A		
29	34 1/2	1 1/2	MACK TRUCKS	SEE 251141	VTH	C	2	16	BL	6 1/4	36 3/8	C	46	A	N	253141
									BL	6 1/4	36 3/8	C	46	A		
29	34 1/2	2 1/4	MACK TRUCKS	SEE 251141	VTH	C	3	16	BL	6 1/4	36 3/8	C	46	A	N	252141
									BL	6 1/4	36 3/8	C	46	A		
29	34 1/2	2 1/4	MACK TRUCKS	SEE 251110	VTH	C	3	14	BL	6	37 1/8	1 1/2	44	A	N	252110
									BL	6	37 1/8	1 1/2	44	A		
29	34 1/2	2 1/4	MACK TRUCKS	SEE 251128	VTH	C	3	16	BL	6 1/4	36 3/8	C	46	A	N	252141
									BL	6 1/4	36 3/8	C	46	A		
29	34 1/2	3	MACK TRUCKS	SEE 251128	VTH	C	4	14	BL	6 1/4	36 3/8	C	46	A	N	252128
									BL	6 1/4	36 3/8	C	46	A		
29	34 3/4	2 1/4	MACK TRUCKS	ULTRA-FUSED E-2416-1 CAN USE 226154 OR 251141	VH	C	3	11	BL	6 1/4	36 3/8	C	46	A	N	284075
									BL	6 1/4	36 3/8	C	46	A		
29 5/16	39 7/8	1 1/2	MACK TRUCKS	MODEL CH ULTRA-FUSED CAN USE 226104	VH	C	2	11	BL	6 1/4	42	C	48	A	N	284841
									BL	6 1/4	42	C	48	A		
29 5/16	39 7/8	2 1/4	MACK TRUCKS	CH ULTRA-FUSED CAN USE 251126	VH	C	3	14	BL	6 1/4	42	C	48	A	N	284045
									BL	6 1/4	42	C	48	A		
29 5/16	39 7/8	3	MACK TRUCKS	CH ULTRA-FUSED CAN USE 226219 OR 251130	VH	C	4	14	BL	6 1/4	42	C	48	A	N	284050
									BL	6 1/4	42	C	48	A		
29 5/16	40	1 1/2	MACK TRUCKS	SEE 251126	VTH	C	2	16	BL	6 1/4	42	C	48	A	N	253126
									BL	6 1/4	42	C	48	A		
29 5/16	40	2 1/4	MACK TRUCKS	SEE 251126	VTH	C	3	14	BL	6 1/4	42	C	48	A	N	252126
									BL	6 1/4	42	C	48	A		
29 5/16	40	1 1/2	MACK TRUCKS	MODEL CH CAN USE 226104	VH	C	2	14	BL	6 1/4	42	C	48	A	N	251106
									BL	6 1/4	42	C	48	A		

Vista-Pro Automotive - Core Catalog

(Cores Sorted by Application)

Height	Width	Depth	Application	Description	Fin Type	Fin Matl	Rows	FPI	BH/TH Type	BH/TH Width	BH/TH Length	BH/TH OHF	BH/TH Bolts	BH/TH Shape	Hdr Support	Part #
MACK TRUCKS (Cont)																
29 5/16	40	1 3/4	MACK TRUCKS	MODEL CH	R	C	3	11	BL BL	6 1/4 6 1/4	42 42	C C	48 48	A A	C	226104
29 5/16	40	2 1/4	MACK TRUCKS	CH CAN USE 226262	VH	C	3	14	BL BL	6 1/4 6 1/4	42 42	C C	48 48	A A	N	251126
29 5/16	40	2 3/8	MACK TRUCKS	CH MODEL X-3780-1	R	C	4	11	BL BL	6 1/4 6 1/4	42 42	C C	48 48	A A	C	226262
29 5/16	40	2 7/8	MACK TRUCKS	CH MODEL X-3780	R	C	5	11	BL BL	6 1/4 6 1/4	42 42	C C	48 48	A A	C	226219
29 5/16	40	3	MACK TRUCKS	CH	VH	C	4	14	BL BL	6 1/4 6 1/4	42 42	C C	48 48	A A	N	251130
30 1/8	25 5/8	2 3/8	MACK TRUCKS	BABY 8	R	C	4	11	GR GR	3 7/16 3 7/16	26 1/8 26 1/8	C C		A A	C	226164
30 3/8	22 1/2	2 7/8	MACK TRUCKS	RENAULT	R	C	5	11	GR GR	3 3/8 3 3/8	22 1/2 22 1/2	C C		A A	C	226582
30 3/8	34 3/8	2 3/8	MACK TRUCKS		R	C	4	11	BL BL	6 1/4 6 1/4	36 3/8 36 3/8	C C	46 46	A A	C	226584
30 3/8	34 3/8	2 7/8	MACK TRUCKS		R	C	5	11	BL BL	6 1/4 6 1/4	36 3/8 36 3/8	C C	46 46	A A	C	226135
30 3/8	34 1/2	2 1/4	MACK TRUCKS	DM RD X-3571, X-3321 CAN USE 226584	VH	C	3	14	BL BL	6 1/4 6 1/4	36 3/8 36 3/8	C C	46 46	A A	N	251003
30 3/8	34 1/2	3	MACK TRUCKS	DM, RD CAN USE 284718 OR 226135	VH	C	4	16	BL BL	6 1/4 6 1/4	36 3/8 36 3/8	C C	46 46	A A	N	251136
30 3/8	34 1/2	1 1/2	MACK TRUCKS	SEE 251003	VTH	C	2	16	BL BL	6 1/4 6 1/4	36 3/8 36 3/8	C C	46 46	A A	N	253003
30 3/8	34 1/2	2 1/4	MACK TRUCKS	SEE 251003	VTH	C	3	14	BL BL	6 1/4 6 1/4	36 3/8 36 3/8	C C	46 46	A A	N	252003
30 3/8	34 1/2	2 1/4	MACK TRUCKS	SEE 251136	VTH	C	3	14	BL BL	6 1/4 6 1/4	36 3/8 36 3/8	C C	46 46	A A	N	253136
30 3/8	34 1/2	3	MACK TRUCKS	SEE 251136	VTH	C	4	16	BL BL	6 1/4 6 1/4	36 3/8 36 3/8	C C	46 46	A A	N	252136
30 3/8	34 3/4	2 1/4	MACK TRUCKS	DM, RD ULTRA FUSED CAN USE 226584 OR 251003	VH	C	3	14	BL BL	6 1/4 6 1/4	36 3/8 36 3/8	C C	46 46	A A	N	284020
30 3/8	34 3/4	3	MACK TRUCKS	ULTRA-FUSED J-3571-03 CAN USE 226135 OR 251136	VH	C	4	16	BL BL	6 1/4 6 1/4	36 3/8 36 3/8	C C	46 46	A A	N	284718
31 5/8	31 1/4	2 3/8	MACK TRUCKS	B73, B75 E-1109-3, X-832-C HVY BTM HDR	R	C	4	9	BL BH	5 3/8 6 3/4	36 3/8 34 1/8	1 7/16 1 3/8	30 30	C B	C	226586
33 1/2	23 3/4	2 7/8	MACK TRUCKS	2MF-5254, X-1962	R	C	5	9	GR GR	6 7/8 3 5/8	24 1/4 24 1/4	5/8 5/8		A A	C	226588
35 5/8	27 1/2	2 3/8	MACK TRUCKS	3MF-5275-P4	R	C	4	11	GR GR	6 1/2 4 7/8	28 1/4 28 1/4	2 1/2 1 3/8		A A	C	226216
35 5/8	27 1/2	2 3/8	MACK TRUCKS	MC, MR	R	C	4	11	GR GR	4 1/4 4 1/4	28 1/4 28 1/4	C C		A A	C	226591
35 5/8	27 1/2	2 7/8	MACK TRUCKS	MC, MR487	R	C	5	11	GR GR	6 1/2 4 7/8	28 1/4 28 1/4	2 1/2 1 3/8		A A	C	226217
35 5/8	27 1/2	2 7/8	MACK TRUCKS	MC, MR	R	C	5	11	GR GR	4 1/4 4 1/4	28 1/4 28 1/4	3/8 3/8		A A	C	226592
37	27 1/2	2 7/8	MACK TRUCKS	WESTERN E-1462-1	R	C	5	11	BL BL	10 1/8 6	29 1/2 29 1/2	1 9/16 1 9/16	42 40	A A	C	226224
37	27 1/2	3 7/16	MACK TRUCKS	WESTERN E-1462-4 HVY BTM HDR	R	C	6	11	BL BH	10 1/8 6	29 1/2 29 1/2	1 7/16 1 7/16	42 40	A A	C	226225
37	27 1/2	3 3/4	MACK TRUCKS	WESTERN	X	C	5	11	BL BL	10 1/8 6	29 1/2 29 1/2	1 1/4 1 1/4	42 40	A A	C	289199
37	27 9/16	3	MACK TRUCKS		T	C	4	9	BL BL	10 1/4 6	29 1/2 29 1/2	1 1/8 1 1/8	42 40	A A	C	264012

Vista-Pro Automotive - Core Catalog

(Cores Sorted by Application)

Height	Width	Depth	Application	Description	Fin Type	Fin Matl	Rows	FPI	BH/TH Type	BH/TH Width	BH/TH Length	BH/TH OHF	BH/TH Bolts	BH/TH Shape	Hdr Support	Part #
MACK TRUCKS (Cont)																
37	27 9/16	3 3/4	MACK TRUCKS	HVY BTM HDR	T	C	5	9	BL BH	10 1/4 6	29 1/2 29 1/2	1 1/4 C	42 40	A A	C	275361
37	30	2 7/8	MACK TRUCKS	MODEL F HVY BTM HDR	R	C	5	11	BL BH	7 3/8 7 3/8	32 1/4 32 1/4	C C	40 40	A A	C	226310
37 3/16	38 1/8	2 3/8	MACK TRUCKS	WESTERN X-1898-1	R	C	4	11	BL BL	6 1/2 6 1/2	40 40	C C	48 48	A A	C	226600
37 3/16	38 1/8	2 7/8	MACK TRUCKS	WESTERN X-1898-2	R	C	5	11	BL BL	6 1/2 6 1/2	40 40	C C	48 48	A A	C	226601
37 1/4	30 5/8	2 3/8	MACK TRUCKS		R	C	4	11	BL BL	6 3/8 6 3/8	33 33	C C	40 40	A A	C	226137
37 1/4	30 3/4	2 1/4	MACK TRUCKS	ULTRA-FUSED CAN USE 226137 OR 251108	VH	C	3	12	BL BL	6 3/8 6 3/8	33 33	C C	40 40	A A	N	284697
37 1/4	31	2 1/4	MACK TRUCKS	CAN USE 226137	VH	C	3	14	BL BL	6 3/8 6 3/8	33 33	C C	40 40	A A	N	251108
37 1/4	31 1/8	1 1/2	MACK TRUCKS	SEE 251108	VTH	C	2	16	BL BL	6 3/8 6 3/8	33 33	C C	40 40	A A	N	253108
37 1/4	31 1/8	2 1/4	MACK TRUCKS	SEE 251108	VTH	C	3	14	BL BL	6 3/8 6 3/8	33 33	C C	40 40	A A	N	252108
38 1/2	27 1/2	2 7/8	MACK TRUCKS	6 7/8" X 6 7/8" CRANK BOX	R	C	5	11	GR GR	4 7/8 4 7/8	28 5/16 28 5/16	1 1/4 1 1/4		A A	C	226818
38 1/2	27 1/2	2 7/8	MACK TRUCKS	6 7/8" X 6 7/8" CRANK BOX OFFSET	R	C	5	11	GR GR	4 7/8 4 7/8	28 5/16 28 5/16	1 1/4 1 1/4		A A	C	226841
38 5/8	34 3/16	2 1/4	MACK TRUCKS	MH, RW ULTRA-FUSED LOW FLOW CAN USE 226005 DIMPLED TUBE	VH	C	3	14	BL BL	6 1/4 6 1/4	36 3/8 36 3/8	1 5/8 1 5/8	46 46	A A	N	284629
38 5/8	34 3/16	3	MACK TRUCKS	MH, RW ULTRA-FUSED LOW FLOW CAN USE 251019 DIMPLED TUBE	VH	C	4	14	BL BL	6 1/4 6 1/4	36 3/8 36 3/8	C C	46 46	A A	N	284628
38 5/8	34 3/16	3	MACK TRUCKS	ULTRA-FUSED CAN USE 226251	VH	C	4	16	BL BL	6 1/4 6 1/4	36 3/8 36 3/8	C C	46 46	A A	N	284724
38 5/8	34 3/8	1 3/4	MACK TRUCKS	CRUISELINER 3MF-5457-P6, E1919-2	R	C	3	11	BL BL	6 1/4 6 1/4	36 3/8 36 3/8	2 1/4 2 1/4	46 46	A A	C	226250
38 5/8	34 3/8	1 3/4	MACK TRUCKS	ULTRA-FUSED CAN USE 226250 OR 251115	R	C	3	11	BL BL	6 1/4 6 1/4	36 3/8 36 3/8	2 1/4 2 1/4	46 46	A A	C	282126
38 5/8	34 3/8	2 3/8	MACK TRUCKS	MH, RW LOW FLOW CAN USE 284629 DIMPLED TUBE	R	C	4	11	BL BL	6 1/4 6 1/4	36 3/8 36 3/8	1 5/8 1 5/8	46 46	A A	C	226005
38 5/8	34 3/8	2 3/8	MACK TRUCKS	CRUISELINER E-1919-1	R	C	4	11	BL BL	6 1/4 6 1/4	36 3/8 36 3/8	1 3/4 1 3/4	46 46	A A	C	226249
38 5/8	34 3/8	2 3/8	MACK TRUCKS	CRUISE LINER ULTRA-FUSED CAN USE 226249 OR 251115	R	C	4	11	BL BL	6 1/4 6 1/4	36 3/8 36 3/8	1 3/4 1 3/4	46 46	A A	C	282125
38 5/8	34 3/8	2 7/8	MACK TRUCKS	MH, RW LOW FLOW DIMPLED TUBE	R	C	5	11	BL BL	6 1/4 6 1/4	36 3/8 36 3/8	C C	46 46	A A	C	226009
38 5/8	34 3/8	2 7/8	MACK TRUCKS	CRUISELINER E-1919-5	R	C	5	11	BL BL	6 1/4 6 1/4	36 3/8 36 3/8	1 11/16 1 11/16	46 46	A A	C	226251
38 5/8	34 1/2	2 1/4	MACK TRUCKS	CRUISE LINER CAN USE 226249	VH	C	3	14	BL BL	6 1/4 6 1/4	36 3/8 36 3/8	1 3/4 1 3/4	46 46	A A	N	251115
38 5/8	34 1/2	3	MACK TRUCKS	MH, RW LOW FLOW DIMPLED TUBE	VH	C	4	15	BL BL	6 1/4 6 1/4	36 3/8 36 3/8	C C	46 46	A A	N	251019
39	26 7/8	2 3/8	MACK TRUCKS	WITH PTO BOX	R	C	4	11	BL BL	6 3/8 6 3/8	28 7/8 28 7/8	2 1/4 2 1/4	38 38	A A	C	286828
39	26 7/8	2 7/8	MACK TRUCKS	6 7/8" X 6 7/8" CRANK BOX	R	C	5	11	BL BL	6 3/8 6 3/8	28 7/8 28 7/8	2 1/8 2 1/8	34 34	A A	C	226812
39	27 1/2	2 3/8	MACK TRUCKS	F MODEL	R	C	4	11	GR GR	4 1/4 4 1/4	28 1/4 28 1/4	C C		A A	C	226226
39 5/8	38 1/8	1 3/4	MACK TRUCKS	WESTERN SUPERLINER E-1739	R	C	3	11	BL BL	6 1/2 6 1/2	40 40	C C	48 48	A A	C	226228

Vista-Pro Automotive - Core Catalog

(Cores Sorted by Application)

Height	Width	Depth	Application	Description	Fin Type	Fin Matl	Rows	FPI	BH / TH Type	BH / TH Width	BH / TH Length	BH / TH OHF	BH / TH Bolts	BH / TH Shape	Hdr Support	Part #
MACK TRUCKS (Cont)																
39 5/8	38 1/8	2 3/8	MACK TRUCKS	SUPERLINER E-1739-1	R	C	4	11	BL BL	6 1/2 6 1/2	40 40	C C	48 48	A A	C	226229
39 5/8	38 1/8	2 7/8	MACK TRUCKS	SUPERLINER E-1739-2	R	C	5	11	BL BL	6 1/2 6 1/2	40 40	C C	48 48	A A	C	226603
39 5/8	38 1/8	3 7/16	MACK TRUCKS	SUPERLINER E-1739-3	R	C	6	11	BL BL	6 1/2 6 1/2	40 40	C C	48 48	A A	C	226230
40 3/16	35	2 3/8	MACK TRUCKS		R	C	4	11	BL BL	6 7/8 6 7/8	37 1/8 37 1/8	C C	44 44	A A	C	226605
40 1/4	34 3/8	2 7/8	MACK TRUCKS	HVY BTM HDR	R	C	5	11	BL BH	6 7/8 6 7/8	37 37	C C	44 44	A A	C	226606
42 1/2	27 1/2	1 3/4	MACK TRUCKS	CRUISELINER COE E-1674-10	R	C	3	11	BL BL	6 1/2 6 1/2	29 1/2 29 1/2	C C	38 38	A A	C	226231
42 1/2	27 1/2	2 3/8	MACK TRUCKS	CRUISELINER COE E-1674-1	R	C	4	11	BL BL	6 1/2 6 1/2	29 1/2 29 1/2	C C	38 38	A A	C	226232
42 1/2	27 1/2	2 7/8	MACK TRUCKS	CRUISELINER COE	R	C	5	11	BL BL	6 1/2 6 1/2	29 1/2 29 1/2	C C	38 38	A A	C	226234
42 1/2	27 1/2	3 7/16	MACK TRUCKS	CRUISELINER COE E-1674-3	R	C	6	11	BL SQ	6 1/2 6 1/2	29 1/2 29 1/2	C C	38 38	A A	C	226236
42 1/2	27 9/16	3	MACK TRUCKS	CRUISELINER COE HVY BTM HDR	T	C	4	11	BL BH	6 1/2 6 1/2	29 1/2 29 1/2	C C	38 38	A A	C	265547
42 7/8	38 1/8	3 7/16	MACK TRUCKS	COE CRUISE LINER	R	C	6	11	BL BL	6 1/2 6 1/2	40 40	C C	48 48	A A	C	226237
43	27 1/2	3 7/16	MACK TRUCKS	WESTERN E-1462-5, E-1555-5 HVY BTM HDR	R	C	6	11	BL BH	10 1/4 6	29 1/2 29 1/2	1 5/16 1 5/16	42 40	A A	C	226238
43 1/4	30 5/8	1 3/4	MACK TRUCKS		R	C	3	11	BL BL	6 3/8 6 3/8	33 33	C C	40 40	A A	C	226610
43 1/4	30 5/8	2 3/8	MACK TRUCKS	R MODEL 3MF-5372-P2, E-1906 CAN USE 282123	R	C	4	11	BL BL	6 3/8 6 3/8	33 33	C C	40 40	A A	C	226239
43 1/4	30 5/8	2 3/8	MACK TRUCKS	ULTRA-FUSED CAN USE 226239	R	C	4	11	BL BL	6 3/8 6 3/8	33 33	2 2	40 40	A A	C	282123
43 1/4	30 5/8	2 7/8	MACK TRUCKS	R MODEL 3MF-5372-P	R	C	5	11	BL BL	6 3/8 6 3/8	33 33	C C	40 40	A A	C	226240
44	34 3/8	2 3/8	MACK TRUCKS	E-1919	R	C	4	11	BL BL	6 1/4 6 1/4	36 3/8 36 3/8	1 3/4 1 3/4	46 46	A A	C	226612
44	34 3/8	2 7/8	MACK TRUCKS	MH, RW LOW FLOW CAN USE 284695 DIMPLED TUBE	R	C	5	11	BL BL	6 1/4 6 1/4	36 3/8 36 3/8	C C	46 46	A A	C	226018
44	34 3/8	2 7/8	MACK TRUCKS	3MF-5395-AM3	R	C	5	11	BL BL	6 1/4 6 1/4	36 3/8 36 3/8	1 3/4 1 3/4	46 46	A A	C	226613
44	34 1/2	3	MACK TRUCKS	MH, RW LOW FLOW CAN USE 284695 DIMPLED TUBE	VH	C	4	15	BL BL	6 1/4 6 1/4	36 3/8 36 3/8	C C	46 46	A A	N	251025
44 9/16	30 5/8	2 3/8	MACK TRUCKS		R	C	4	9	BL BL	6 3/8 6 3/8	33 33	1 1/2 1 1/2	40 40	A A	C	226241
44 9/16	30 5/8	2 7/8	MACK TRUCKS		R	C	5	10	BL BL	6 3/8 6 3/8	33 33	C C	40 40	A A	C	226615
MANITOWOC																
35 3/4	33 3/4	3 3/4	MANITOWOC	NORTHWEST CRANE HVY BTM HDR	T	C	5	7	BL BH	6 3/4 6 3/4	35 3/4 35 3/4	1 1/4 1 1/4	36 36	A A	C	223299
48	37 1/2	4 7/16	MANITOWOC	3600 CRANE HVY BTM HDR BRASS FINS	Z	B	6	8	BL BH	8 1/4 8 1/4	40 1/4 40 1/4	C C	50 50	A A	C	289570
48	37 1/2	5 3/16	MANITOWOC	3900 CRANE HVY T/BTM HDRS BRASS FINS	Z	B	7	9	BH BH	8 1/4 8 1/4	40 1/4 40 1/4	C C	50 50	A A	C	286856
48	37 11/16	4 1/2	MANITOWOC	3600 CRANE HVY T/BTM HDRS	T	C	6	8	BH BH	8 1/4 8 1/4	40 1/4 40 1/4	C C	50 50	A A	C	278428

Vista-Pro Automotive - Core Catalog

(Cores Sorted by Application)

Height	Width	Depth	Application	Description	Fin Type	Fin Matl	Rows	FPI	BH/TH Type	BH/TH Width	BH/TH Length	BH/TH OHF	BH/TH Bolts	BH/TH Shape	Hdr Support	Part #
MANITOWOC (Cont)																
54 1/8	55 1/8	4 1/2	MANITOWOC	HVY T/BTM HDRS	T	C	6	10	BH BH	8 1/4 8 1/4	57 1/2 57 1/2	C C	66 66	A A	CC	223271
56 1/8	36 1/4	6	MANITOWOC	DRAG LINE HVY T/BTM HDR BRASS FINS	Z	B	8	8	BH BH	10 10	39 1/8 39 1/8	C C	50 50	A A	C	282499
MARMON TRUCK																
39 7/8	30	3 7/16	MARMON TRUCK	HVY BTM HDR	R	C	6	11	BL BH	10 1/2 8	31 3/4 31 3/4	1 3/4 1 3/4	42 40	A A	C	226620
40	30	3 7/16	MARMON TRUCK		R	C	6	11	BL BL	10 1/2 8	31 3/4 31 3/4	1 3/4 1 3/4	42 40	A A	C	226622
MASSEY FERGUSON																
13 7/8	13 1/2	2 1/4	MASSEY-FERGUSON		T	C	3	6	GR GR	4 1/4 4 1/4	14 3/8 14 3/8	1/4 1/4		A A	N	261592
13 7/8	13 3/4	2 3/16	MASSEY-FERGUSON	MODEL 11	Z	C	3	7	SQ SQ	4 1/8 4 1/8	14 1/4 14 1/4	1/16 1/16		A A	N	287243
14 3/4	15 3/4	3	MASSEY-FERGUSON		T	C	4	9	GR GR	5 1/8 3 7/8	15 3/4 15 3/4	C C		A A	N	279812
16 3/4	19 1/8	3	MASSEY-FERGUSON	333	T	C	4	8	GR GR	6 3 1/2	19 1/2 19 1/2	1/2 1/2		A A	N	261598
16 7/8	15 3/16	2 1/4	MASSEY-FERGUSON	81	T	C	3	6	GR GR	4 1/8 2 5/8	15 15	C C		A A	N	223249
17 1/4	15 3/16	2 1/4	MASSEY-FERGUSON	DIESEL DIAMOND T/HDR OUTLET BTM HDR	T	C	3	7	SH GR	4 3/4 2 13/16	15 5/8 15 11/16	C C		SP A	N	263125
17 1/4	15 3/16	2 1/4	MASSEY-FERGUSON	DIAMOND T/HDR OUTLET BTM HDR	T	C	3	8	SH GR	4 3/4 2 13/16	15 3/4 15 3/4	C C		SP A	N	275233
17 3/8	15 3/4	2 1/4	MASSEY-FERGUSON	MODEL 30	T	C	3	8	GR GR	5 15/16 2 3/8	15 7/8 15 7/8	7/8 C		A A	N	223265
17 3/8	15 3/4	2 1/4	MASSEY-FERGUSON	101 JUNIOR	T	C	3	8	GR GR	5 15/16 2 3/8	15 7/8 15 7/8	1 1/2 C		A A	N	270271
17 1/2	15 5/8	2 3/16	MASSEY-FERGUSON	101 JUNIOR	Z	C	3	7	GR GR	6 2 1/2	15 7/8 15 7/8	1 3/16		A A	N	280144
17 1/2	18	2 1/4	MASSEY-FERGUSON		T	C	3	9	GR GR	4 2 1/2	18 1/4 18 1/4	1/2 C		A A	N	272725
17 5/8	18 1/8	2 1/4	MASSEY-FERGUSON	40B	X	C	3	8	GR GR	4 2 1/2	18 3/8 18 3/8	1 1/4 C		A A	N	281828
18 3/8	18 1/8	3	MASSEY-FERGUSON	1085	X	C	4	8	GR GR	4 3 1/8	18 3/8 18 3/8	C C		A A	N	281940
18 1/2	15 3/16	2 1/4	MASSEY-FERGUSON	B/HDR OFFSET FOR OUTLET	T	C	3	7	SH SH	4 3/4 4	15 5/8 15 5/8	C 1/4		SP A	N	223132
18 3/4	15 5/8	2 3/16	MASSEY-FERGUSON	FERGUSON DIAMOND T/HDR	Z	C	3	9	SH GR	4 2 3/8	15 7/8 15 3/4	C C		SP A	N	225482
18 3/4	15 5/8	2 3/16	MASSEY-FERGUSON	DIAMOND T/HDR	Z	C	3	9	SH GR	4 1/8 2 3/8	15 3/4 15 3/4	C C		SP A	N	288685
18 3/4	19 1/8	2 1/4	MASSEY-FERGUSON		T	C	3	9		3 1/4 2 3/8	19 3/4 19 3/4	1/4 C		0 0	N	262797
18 7/8	19 1/8	2 1/4	MASSEY-FERGUSON	MODEL 44, 4 CYL	T	C	3	8	GR GR	6 3 1/2	19 7/8 19 7/8	2 5/8 C		A A	N	260804
18 7/8	19 3/8	3	MASSEY-FERGUSON	44 LOADER	X	C	4	8	GR GR	6 3 1/2	19 7/8 19 7/8	2 3/8 3/8		A A	N	288677
19 1/16	18 1/8	2 3/16	MASSEY-FERGUSON		Z	C	3	10	GR GR	5 2 7/16	18 1/4 18 3/8	3/16 3/16		A A	N	287750
19 1/8	18	2 1/4	MASSEY-FERGUSON	MODEL 85	T	C	3	8	GR GR	5 2 7/16	18 1/4 18 3/8	1/4 C		A A	N	223611
19 1/8	18	2 1/4	MASSEY-FERGUSON	85	T	C	3	9	GR GR	5 2 7/16	18 1/4 18 3/8	C 1/4		A A	N	278437

Vista-Pro Automotive - Core Catalog

(Cores Sorted by Application)

Height	Width	Depth	Application	Description	Fin Type	Fin Matl	Rows	FPI	BH/TH Type	BH/TH Width	BH/TH Length	BH/TH OHF	BH/TH Bolts	BH/TH Shape	Hdr Support	Part #
MASSEY FERGUSON (Cont)																
19 1/8	18 1/8	2 1/4	MASSEY-FERGUSON		X	C	3	8	GR	5	18 1/4	3/16		A	N	265974
									GR	2 7/16	18 3/8	3/16		A	N	221834
19 1/4	15 5/8	2 1/4	MASSEY-FERGUSON		X	C	3	8	GR	4 1/2	15 3/4	C		A	N	221834
									GR	2 1/2	15 3/4	C		A	N	279816
19 1/4	18	3	MASSEY-FERGUSON	FERGUSON 85 DIESEL	T	C	4	9	GR	5	18 1/4	3/16		A	N	279816
									GR	3	18 1/4	C		A	N	286611
19 1/4	18 1/8	2 3/16	MASSEY-FERGUSON		Z	C	3	10	GR	5	18 3/8	2 3/4		A	N	286611
									GR	2 1/2	18 3/8	C		A	N	281974
20 1/2	23 3/4	2 1/4	MASSEY-FERGUSON		X	C	3	7	SQ	4	24	1 1/4		A	N	281974
									SQ	4	24	1 1/4		A	N	279818
21 7/8	18	3 3/4	MASSEY-FERGUSON	1130	T	C	5	9	GR	5 1/4	18 1/2	3/16		A	N	279818
									GR	4	18 1/2	3/16		A	N	289843
21 7/8	18 1/8	3 11/16	MASSEY-FERGUSON	1130	Z	C	5	9	GR	5 1/4	18 1/2	3/16		A	N	289843
									GR	4	18 1/2	3/16		A	N	279819
22	17 7/16	3	MASSEY-FERGUSON		T	C	4	8	GR	4 7/8	18 1/4	C		A	N	279819
									GR	3 1/8	18 1/4	C		A	N	279820
22	17 7/16	3 3/4	MASSEY-FERGUSON		T	C	5	9	GR	5	18 1/4	C		A	N	279820
									GR	4	18 1/4	C		A	N	286508
22	17 1/2	3 3/4	MASSEY-FERGUSON	1130	X	C	5	9	GR	5	18 1/4	3/16		A	N	286508
									GR	4	18 1/4	3/16		A	N	265966
22	18 1/8	3	MASSEY-FERGUSON	1100	X	C	4	8	GR	5	18 1/2	1/8		A	N	265966
									GR	3 1/4	18 1/2	C		A	N	265907
22 3/4	31 1/2	4 1/2	MASSEY-FERGUSON	760 COMBINE	T	C	6	6	GR	4 3/4	31 3/4	C		A	N	265907
									GR	4 3/4	31 3/4	C		A	N	260690
23	19 1/8	3	MASSEY-FERGUSON		T	C	4	8	GR	6	19 5/8	3/4		A	N	260690
									GR	3 1/2	19 5/8	C		A	N	279821
23	24 3/16	3 3/4	MASSEY-FERGUSON		T	C	5	9	GR	5	24 1/4	1/8		A	N	279821
									GR	4 1/8	24 1/4	1/8		A	N	289875
23	24 3/8	3 3/4	MASSEY-FERGUSON		X	C	5	9	GR	5	24 1/4	C		A	N	289875
									GR	4	24 1/4	C		A	N	275365
24	25 1/2	3	MASSEY-FERGUSON	410 COMBINE	B	C	4	7	GR	3 1/4	25 3/4	C		A	C	275365
									GR	3 1/4	25 3/4	C		A	C	277411
31 3/4	28 11/16	3 3/4	MASSEY-FERGUSON	1800 INL T/HDR	T	C	5	7	BL	10 1/4	31 1/2	1 3/16	46	A	C	277411
									BL	6	31 1/2	1 3/16	42	A	C	281987
31 3/4	28 3/4	3 11/16	MASSEY-FERGUSON	MODEL 1805 BRASS FINS	Z	B	5	11	BL	6 7/16	31 1/2	1 1/4	42	A	C	281987
									BL	6 1/8	31 1/2	C	42	A	C	265972
31 3/4	28 3/4	3 3/4	MASSEY-FERGUSON	1800 W/CAT ENGINE HVY BTM HDR	X	C	5	10	BL	10 1/4	31 1/2	1 1/4	46	A	C	265972
									BH	6 1/8	31 1/2	1 1/4	42	A	C	272726
37	34 5/16	3	MASSEY-FERGUSON	HVY BTM HDR	T	C	4	8	BL	6 1/8	36 3/4	1 1/4	46	H	C	272726
									BH	6 1/8	36 3/4	1 1/4	46	H	C	286971
37 5/8	34 3/8	3 3/4	MASSEY-FERGUSON		X	C	5	9	BL	6 1/8	36 3/4	C	46	B	C	286971
									BL	6 1/8	36 3/4	C	46	B	C	
MATADOR																
16 7/8	24 3/16	1 1/4	MATADOR		VT	C	2	16	GR	2 1/4	24	3/16		A	N	124697
									GR	2 1/4	24	3/16		A	N	
MAVERICK																
16 3/8	20 3/8	1 1/4	MAVERICK		VT	C	2	12	BU	3 3/16	20 7/16	C		A	N	124646
									GR	1 5/8	19 13/16	C		A	N	
MAZDA																
10 5/8	22	2	MAZDA		VT	C	3	12	GR	2 1/2	21 3/4	C		A	N	124752
									GR	2 1/2	21 3/4	C		A	N	124792
11 3/8	21 7/16	2	MAZDA		VT	C	3	12	GR	2 1/2	21 3/4	C		A	N	124792
									GR	2 1/2	21 3/4	C		A	N	128250
11 3/4	17 3/4	1	MAZDA		VE	C	2	18	GR	1 3/4	17 7/8	C		A	N	128250
									GR	1 3/4	17 7/8	C		A	N	

Vista-Pro Automotive - Core Catalog

(Cores Sorted by Application)

Height	Width	Depth	Application	Description	Fln Type	Fln Matl	Rows	FPI	BH/TH Type	BH/TH Width	BH/TH Length	BH/TH OHF	BH/TH Bolts	BH/TH Shape	Hdr Support	Part #
MAZDA (Cont)																
12 5/8	23 5/8	2	MAZDA		VT	C	3	12	GR	2 3/8	24	C		A	N	124754
									GR	2 3/8	24	C		A	N	128672
12 3/4	18 1/8	1 1/4	MAZDA		VT	C	2	12	GR	1 7/8	18 1/4	C		A	N	128672
									GR	1 7/8	18 1/4	C		A	N	128766
13 3/4	22 9/16	1 1/4	MAZDA		VT	C	2	12	GR	1 3/4	22 5/8	C		A	N	128766
									GR	1 3/4	22 5/8	C		A	N	128563
14 3/4	22 9/16	1 1/4	MAZDA		VT	C	2	12	GR	1 13/16	22 7/16	C		A	N	128563
									GR	1 13/16	22 7/16	C		A	N	128215
16 1/8	21 1/16	1	MAZDA		VE	C	2	14	GR	1 3/4	21 7/16	C		A	N	128215
									GR	1 3/4	21 7/16	C		A	N	122691
16 1/8	21 1/2	1 9/16	MAZDA		VE	C	3	14	GR	1 3/4	21 7/16	C		A	N	122691
									GR	1 3/4	21 7/16	C		A	N	124708
16 3/4	12 5/8	2	MAZDA		VT	C	3	12		2 1/2	12 1/2	C		0	N	124708
										2 1/2	12 1/2	C		0	N	
MB																
15 11/16	16 5/16	2 1/4	MB		T	C	3	11	GR	2 5/16	16	C		A	N	262893
									GR	2 5/16	18 1/2	C		A	N	265097
16 5/8	22 1/2	1 7/8	MB		X	C	2	11	GR	2 1/8	22 3/8	C		A	N	265097
									GR	2 1/8	22 3/8	C		A	N	
MERCEDES BENZ																
13 5/8	22 9/16	2	MERCEDES-BENZ		VT	C	3	12	GR	2 1/4	22 3/8	C		A	N	128330
									GR	2 1/4	22 3/8	C		A	N	122695
15 1/4	19 13/16	2	MERCEDES BENZ		VT	C	3	14	GR	2 1/8	20 1/8	C		A	N	122695
									GR	2 1/8	20 1/8	C		A	N	128373
15 1/4	20 3/8	2	MERCEDES BENZ		VT	C	3	12	GR	2 1/16	20 1/16	C		A	N	128373
									GR	2 1/16	20 1/16	C		A	N	128340
15 3/4	18 11/16	1 1/4	MERCEDES BENZ		VT	C	2	14	GR	2 1/2	18 5/8	C		A	N	128340
									GR	2 1/2	18 5/8	C		A	N	128813
15 3/4	18 11/16	2	MERCEDES BENZ		VT	C	3	14	GR	2 1/2	18 5/8	C		A	N	128813
									GR	2 1/2	18 5/8	C		A	N	128438
15 3/4	18 11/16	2	MERCEDES-BENZ		VT	C	3	12	GR	2 1/4	18 1/2	C		A	N	128438
									GR	2 1/4	18 1/2	C		A	N	124776
16	24 3/16	2	MERCEDES BENZ		VT	C	3	14	GR	2 3/8	23 7/8	C		A	N	124776
									GR	2 3/8	23 7/8	C		A	N	124858
16	26 15/16	1 1/4	MERCEDES-BENZ		VT	C	2	12	GR	2 1/8	27 1/2	C		A	N	124858
									GR	2 1/8	27 1/2	C		A	N	124859
16	26 15/16	2	MERCEDES BENZ		VT	C	3	14	GR	2 1/8	27 1/4	C		A	N	124859
									GR	2 1/8	27 1/4	C		A	N	122681
16	27 1/4	1 9/16	MERCEDES BENZ		VE	C	3	14	GR	2 1/8	27 1/4	C		A	N	122681
									GR	2 1/8	27 1/4	C		A	N	128497
16 1/2	18 1/8	2	MERCEDES BENZ		VT	C	3	12	GR	2 3/16	18	C		A	N	128497
									GR	2 3/16	18	C		A	N	128551
16 1/2	20 3/8	2	MERCEDES BENZ		VT	C	3	12	FR	2 1/8	20 5/8	C		A	N	128551
									FR	2 1/8	20 5/8	C		A	N	128632
16 1/2	20 7/8	1 1/4	MERCEDES BENZ		VT	C	2	14	GR	2 1/4	20 5/8	C		A	N	128632
									GR	2 1/4	20 5/8	C		A	N	124802
16 1/2	20 7/8	2	MERCEDES BENZ		VT	C	3	12	GR	2 1/4	20 5/8	C		A	N	124802
									GR	2 1/4	20 5/8	C		A	N	128222
16 1/2	23 9/16	1 9/16	MERCEDES BENZ		VE	C	3	17	GR	2 1/8	23 3/8	C		A	N	128222
									GR	2 1/8	23 3/8	C		A	N	124710
16 1/2	23 5/8	1 1/4	MERCEDES-BENZ		VT	C	2	16	GR	2 1/8	23 3/8	C		A	N	124710
									GR	2 1/8	23 3/8	C		A	N	128714
16 5/8	24 3/4	2	MERCEDES BENZ		VT	C	3	12	GR	2 1/4	25 1/4	C		A	N	128714
									GR	2 1/4	25 1/4	C		A	N	

Vista-Pro Automotive - Core Catalog

(Cores Sorted by Application)

Height	Width	Depth	Application	Description	Fin Type	Fin Matl	Rows	FPI	BH/TH Type	BH/TH Width	BH/TH Length	BH/TH OHF	BH/TH Bolts	BH/TH Shape	Hdr Support	Part #
MERCEDES BENZ (Cont)																
16 5/8	25 7/8	2	MERCEDES BENZ		VT	C	3	14	GR	2 1/8	25 5/8	C		A	N	122682
									GR	2 1/8	25 5/8	C		A	N	128179
16 5/8	25 7/8	2	MERCEDES BENZ		VT	C	3	14	GR	2 1/8	25 5/8	C		A	N	128179
									GR	2 1/8	25 5/8	C		A	N	128179
16 3/4	20 3/8	2 5/8	MERCEDES-BENZ		VT	C	4	12	GR	3 1/16	20 1/2	C		A	N	128321
									GR	3 1/16	20 1/2	C		A	N	128321
16 3/4	22	2 5/8	MERCEDES BENZ		VT	C	4	12	GR	3 1/8	22 1/4	C		A	N	128351
									GR	3 1/8	22 1/4	C		A	N	128351
16 3/4	23 1/8	2	MERCEDES BENZ		VT	C	3	12	GR	2 1/4	23 1/4	C		A	N	128177
									GR	2 1/4	23 1/4	C		A	N	128177
16 3/4	25 7/8	1 1/4	MERCEDES-BENZ		VT	C	2	12	GR	2	25 3/4	C		A	N	128123
									GR	2	25 3/4	C		A	N	128123
16 7/8	22	2	MERCEDES BENZ		VT	C	3	14	GR	2 1/4	22 1/8	C		A	N	124803
									GR	2 1/4	22 1/8	C		A	N	124803
17 1/4	18 11/16	2	MERCEDES-BENZ		VT	C	3	12	GR	2 1/4	18 1/2	C		A	N	128322
									GR	2 1/4	21 1/2	C		A	N	128322
17 1/2	18 11/16	2 5/8	MERCEDES-BENZ		VT	C	4	12	GR	2 7/8	18 1/2	C		A	N	128323
									GR	2 7/8	18 1/2	C		A	N	128323
17 1/2	24 3/16	2 5/8	MERCEDES BENZ		VT	C	4	12	GR	3 1/2	24 1/2	C		A	N	128715
									GR	3 1/2	24 1/2	C		A	N	128715
17 3/4	18 11/16	2	MERCEDES BENZ		VT	C	3	12		2 1/8	18	C		0	N	128422
										2 1/8	18	C		0	N	128422
17 3/4	22	2	MERCEDES BENZ		VT	C	3	14	GR	2 1/4	22 5/8	C		A	N	128178
									GR	2 1/4	22 5/8	C		A	N	128178
17 3/4	22	2	MERCEDES-BENZ		VT	C	3	16	GR	2 3/8	22	C		A	N	128248
									GR	2 3/8	22	C		A	N	128248
17 3/4	22 9/16	2	MERCEDES BENZ		VT	C	3	12	FR	2 1/8	22 1/2	C		0	N	128719
									FR	2 1/8	22 1/2	C		A	N	128719
18	20 1/4	1 9/16	MERCEDES BENZ		VE	C	3	14	GR	2 1/2	20 1/8	C		A	N	128799
									GR	2 1/2	20 1/8	C		A	N	128799
18	20 3/8	2	MERCEDES BENZ		VT	C	3	14	GR	2 1/2	20 1/8	C		A	N	122456
									GR	2 1/2	20 1/8	C		A	N	122456
18	25 7/8	1 1/4	MERCEDES-BENZ		VT	C	2	14	GR	2 1/8	25 3/8	C		A	N	124860
									GR	2 1/8	25 5/8	C		A	N	124860
18	25 7/8	2	MERCEDES BENZ		VT	C	3	14	GR	2 1/8	25 3/4	C		A	N	128446
									GR	2 1/8	25 3/4	C		A	N	128446
18	25 7/8	2	MERCEDES BENZ		VT	C	3	12	GR	2 1/4	25 5/8	C		A	N	124916
									GR	2 1/4	25 5/8	C		A	N	124916
18 1/8	20 3/8	1 1/4	MERCEDES BENZ		VT	C	2	16	GR	2 3/8	20 1/8	C		A	N	128202
									GR	2 3/8	20 1/8	C		A	N	128202
26 1/2	25 5/8	2 3/8	MERCEDES BENZ TRUCK	1390	R	C	4	11	GR	3	26 5/8	C		A	C	226625
									GR	3	26 5/8	C		A	C	226625
MERCURY																
16 3/8	17 1/16	1 1/4	MERCURY	COMET	VT	C	2	12	BU	3 3/16	17 3/8	C		A	N	124833
									GR	1 11/16	16 3/4	C		A	N	124833
22 7/16	17 5/8	1 1/4	MERCURY		VT	C	2	12	GR	2 1/4	17 7/16	C		A	N	122235
									GR	2 1/4	17 7/16	C		A	N	122235
24 1/2	18 1/8	2	MERCURY		VT	C	3	14	GR	2 13/16	18 7/8	5/16		A	N	124742
									GR	2 13/16	18 7/8	5/16		A	N	124742
METRO BUS																
29 1/2	24 3/4	4 3/8	METRO BUS		T	C	6	10	BL	7 5/8	27	C	38	A	C	289979
									BL	7 5/8	27	C	38	A	C	289979

Vista-Pro Automotive - Core Catalog

(Cores Sorted by Application)

Height	Width	Depth	Application	Description	Fin Type	Fin Matl	Rows	FPI	BH / TH Type	BH / TH Width	BH / TH Length	BH / TH OHF	BH / TH Bolts	BH / TH Shape	Hdr Support	Part #
MG																
10 5/16	18	2 1/4	MG		T	C	3	11	GR	2 3/4	18 1/2	C		A	N	261784
									GR	2 3/4	18 1/2	C		A		
10 5/16	18 1/8	2	MG		VT	C	3	14	GR	2 3/4	18 5/8	C		A	N	124807
									GR	2 3/4	18 5/8	C		A		
11 3/8	14 7/8	2	MG		VT	C	3	12	GR	5	14 3/4	3/8		A	N	128339
									FR	2 1/8	14 3/4	C		A		
11 5/8	13 3/4	2	MG		VT	C	3	12	GR	5	14 3/4	C		A	N	128364
									GR	2 1/4	14 3/4	C		A		
12 3/4	12 3/8	3	MG		T	C	4	11	GR	3 1/4	12 3/4	C		A	N	264346
									GR	3 1/4	12 3/4	C		A		
14	18 1/8	2	MG		VT	C	3	12	GR	2 3/4	18 7/16	C		A	N	124915
									GR	2 3/4	18 7/16	C		A		
14 1/16	19 13/16	2	MG		VT	C	3	12	GR	2 1/2	20	C		A	N	128383
									GR	2 1/2	20	C		A		
14 1/4	10 7/16	1 1/4	MG		VT	C	2	15		2	11	C		0	N	124810
										2	11	C		0		
16 1/4	13 1/8	1 7/8	MG		X	C	2	8	GR	8 1/4	13 1/2	3/4		A	N	260773
									GR	2 3/8	13 1/2	C		A		
16 5/8	10 7/16	1 1/4	MG		VT	C	2	12		2	11	C		0	N	124856
										2	11	C		0		
16 5/8	10 7/16	2	MG		VT	C	3	12		2 1/8	11	C		0	N	128111
										2 1/8	11	C		0		
MILITARY																
24 3/8	26 15/16	2 5/8	MILITARY	MILITARY CORE "M998"	VT	C	4	12	GR	3 1/2	28	C		A	N	220037
									GR	3 1/2	28	C		A		
29 1/4	28 3/4	4 7/16	MILITARY	MILITARY CORE "LAV"	R	C	8	10	SQ	5 1/4	30 1/8	C		A	C	220035
									SQ	5 1/4	30 1/8	C		A		
43 1/4	46 1/4	2 7/8	MILITARY	MILITARY CORE, LVS-MK-48	R	C	5	10	BH	7 3/4	49	C	60	0	CC	220036
									BH	7 3/4	49	C	60	0		
MILLER																
16 1/2	19 3/8	1 1/4	MILLER ELECTRIC	PERKINS ENGINE	R	C	2	9	GR	3 1/4	19 5/8	1 1/4		A	N	226626
									GR	2 1/4	19 5/8	C		A		
16 9/16	19 13/16	2	MILLER ELECTRIC		VT	C	3	12	GR	3 1/8	19 5/8	15/16		A	N	128590
									GR	2 3/8	19 5/8	C		A		
16 5/8	19 11/16	2 1/4	MILLER ELECTRIC		T	C	3	8	GR	3 1/8	19 5/8	C		A	N	272731
									GR	2 1/4	19 5/8	C		A		
16 5/8	19 13/16	1 1/4	MILLER WELDER		VT	C	2	12	GR	3 3/8	19 5/8	3/8		A	N	128109
									GR	2 3/8	19 3/4	1/4		A		
16 7/8	18 1/8	2	MILLER WELDER		VT	C	3	12	GR	5 7/16	18 1/4	3/16		A	N	124932
									GR	3	18 1/4	3/16		A		
MINNEAPOLIS MOLINE																
16 1/2	16 7/8	2 1/4	MINNEAPOLIS MOLINE		T	C	3	7	BL	4 1/8	19 1/8	C	20	F	C	260950
									BL	4 1/8	19 1/8	C	20	F		
16 9/16	16 7/8	2 3/16	MINNEAPOLIS MOLINE	ZA-JTU	Z	C	3	9	BL	4 1/8	19 1/8	1	20	F	C	281479
									BL	4 1/8	19 1/8	1	20	F		
16 5/8	16 7/8	2 1/4	MINNEAPOLIS MOLINE		T	C	3	8	BL	4 1/8	19 1/8	C	20	F	C	270950
									BL	4 1/8	19 1/8	C	20	F		
17 7/8	18 3/4	2 1/4	MINNEAPOLIS MOLINE		X	C	3	6	BL	4 1/8	20 3/4	C	23	F	C	260204
									BL	4 1/8	20 3/4	C	23	F		
19 1/4	17 1/2	2 1/4	MINNEAPOLIS MOLINE	U, UTU	X	C	3	7	GR	6 3/8	18	5/16		A	N	281458
									GR	3	18	5/16		A		
19 1/4	18	2 1/4	MINNEAPOLIS MOLINE	UTA, UTU	T	C	3	8	GR	6 3/8	18	1/4		A	N	223612
									GR	3	18	1/4		A		
19 1/4	18 1/8	2 3/16	MINNEAPOLIS MOLINE	UTU, UTA	Z	C	3	9	GR	6 3/8	18	1/4		A	N	288164
									GR	3	18	1/4		A		

Vista-Pro Automotive - Core Catalog

(Cores Sorted by Application)

Height	Width	Depth	Application	Description	Fin Type	Fin Matl	Rows	FPI	BH/TH Type	BH/TH Width	BH/TH Length	BH/TH OHF	BH/TH Bolts	BH/TH Shape	Hdr Support	Part #
MINNEAPOLIS MOLINE (Cont)																
19 3/8	16 7/8	2 3/16	MINNEAPOLIS MOLINE	JET STAR	Z	C	3	9	GR BL	3 1/2 4 7/8	17 7/8 19 7/8	3/8 1 1/8	20	A A	C	287760
19 3/8	17 7/16	2 1/4	MINNEAPOLIS MOLINE	445 HVY BTM HDR	T	C	3	8	GR BH	3 1/2 4 7/8	17 7/8 19 7/8	1 1 5/8	20	A A	C	223266
20 1/2	17 7/16	2 1/4	MINNEAPOLIS MOLINE	2066-4 SWEEPER	T	C	3	9	GR GR	3 1/2 3 1/2	18 18	C C		A A	N	279845
21 3/16	18	2 1/4	MINNEAPOLIS MOLINE	UBU	T	C	3	8	BL BL	4 7/8 4 7/8	20 11/16 20 11/16	C C	20 20	F F	C	273448
21 3/16	18 3/4	2 1/4	MINNEAPOLIS MOLINE	UDU	X	C	3	7	BL BL	4 7/8 4 7/8	20 11/16 20 11/16	C C	20 20	F F	C	274471
21 3/16	19 3/8	2 1/4	MINNEAPOLIS MOLINE	KEF-PU	X	C	3	7	BL BL	5 3/8 5 3/8	22 11/16 22 11/16	1 5/16 1 5/16	21 21	J J	C	281461
21 3/8	19 3/8	2 3/16	MINNEAPOLIS MOLINE	5 STAR	Z	C	3	9	GR BL	3 3/8 5	19 7/8 21 7/8	15/16 1 3/4	22	A F	C	287465
21 3/8	19 11/16	2 1/4	MINNEAPOLIS MOLINE	HVY BTM HDR	T	C	3	9	SQ BH	3 3/8 5	19 7/8 21 7/8	1 1 5/8	22	A F	C	261731
21 1/2	19 3/8	2 1/4	MINNEAPOLIS MOLINE	M5, M602, M670	X	C	3	9	GR BL	3 3/8 5	19 7/8 21 7/8	13/16 1 5/8	22	A F	C	288417
22 5/16	21 15/16	2 1/4	MINNEAPOLIS MOLINE	336 TM-3230B	T	C	3	8	BL BL	5 7/8 5 7/8	24 5/8 24 5/8	1 5/16 1 5/16	24 24	A A	C	260633
22 3/8	22 1/2	2 1/4	MINNEAPOLIS MOLINE	UB 283-GTB-403	T	C	3	7	BL BL	6 6	24 3/4 24 3/4	1 3/8 1 3/8	24	F F	C	270633
22 3/8	22 1/2	2 1/4	MINNEAPOLIS MOLINE	UB 283-GTB-403	X	C	3	9	BL BL	5 7/8 5 7/8	24 5/8 24 5/8	1 3/16 1 3/16	24	F F	C	281456
22 3/8	22 1/2	3	MINNEAPOLIS MOLINE		X	C	4	8	BL BL	5 7/8 5 7/8	24 5/8 24 5/8	1 3/16 1 3/16	24	F F	C	288694
25	19 3/8	3	MINNEAPOLIS MOLINE	G1000	X	C	4	8	GR GR	3 3/8 3 3/8	19 5/8 19 5/8	5/16 5/16		A A	C	288698
25 1/8	19 1/8	2 1/4	MINNEAPOLIS MOLINE	670 SUPER	T	C	3	8	GR GR	3 3/8 3 3/8	19 7/8 19 7/8	1/4 1/4		A A	C	279847
25 1/8	19 3/8	2 1/4	MINNEAPOLIS MOLINE	670 SUPER	X	C	3	9	GR GR	3 3/8 3 3/8	19 7/8 19 7/8	1/4 1/4		A A	C	288923
27 7/8	26 7/8	3	MINNEAPOLIS MOLINE	800	X	C	4	8	BL BL	5 7/8 5 7/8	28 5/8 28 5/8	1 1/4 1 1/4	28	F F	C	288291
27 15/16	26 1/4	3	MINNEAPOLIS MOLINE	800, 6 CYL	X	C	4	7	BL BL	5 7/8 5 7/8	28 5/8 28 5/8	C C	28	A A	C	274469
27 15/16	26 7/16	2 1/4	MINNEAPOLIS MOLINE	605-6A,1210-12A	T	C	3	8	BL BL	5 7/8 5 7/8	28 5/8 28 5/8	C C	28	A A	C	271377
28	26 7/16	2 1/4	MINNEAPOLIS MOLINE		T	C	3	9	BL BL	5 7/8 5 7/8	28 5/8 28 5/8	1 5/16 1 5/16	28	A A	C	261710
28	26 7/16	3 3/4	MINNEAPOLIS MOLINE	800	T	C	5	9	BL BL	5 7/8 5 7/8	28 5/8 28 5/8	C C	28	A A	C	263435
29 7/8	30	4 7/16	MINNEAPOLIS MOLINE	BRASS FINS	Z	B	6	8	BL BL	7 1/2 7 1/2	32 1/8 32 1/8	C C	28	A A	C	288892
29 15/16	26 7/8	2 1/4	MINNEAPOLIS MOLINE	HEB, HUA, KES	X	C	3	7	BL BL	7 7	30 30	C C	30	A A	C	270441
mitsubishi																
13 3/4	23 5/8	1 1/4	MITSUBISHI		VT	C	2	14	GR GR	1 3/4 1 3/4	23 7/8 23 7/8	C C		A A	N	128566
14 5/8	23 5/8	1 1/4	MITSUBISHI		VT	C	2	14	GR GR	1 3/4 1 3/4	23 13/16 23 13/16	C C		A A	N	128943
16 5/8	23 5/8	1 1/4	MITSUBISHI		VT	C	2	15	GR GR	2 1/2 2 1/2	23 3/4 23 3/4	C C		A A	N	128837

Vista-Pro Automotive - Core Catalog

(Cores Sorted by Application)

Height	Width	Depth	Application	Description	Fln Type	Fln Matl	Rows	FPI	BH/TH Type	BH/TH Width	BH/TH Length	BH/TH OHF	BH/TH Bolts	BH/TH Shape	Hdr Support	Part #
MONTGOMERY WARD																
14 1/2	15 3/16	2 1/4	MONTGOMERY WARD	TRACTOR	T	C	3	7	GR	6	15 5/8	1/8		A	N	271007
									GR	2 1/2	15 5/8	1/8		A		
14 1/2	15 5/8	2 3/16	MONTGOMERY WARD	TRACTOR	Z	C	3	10	GR	6	15 5/8	3/16		A	N	280173
									GR	2 1/2	15 5/8	3/16		A		
MORRIS																
10 1/8	21 1/4	1 7/8	MORRIS		X	C	2	9	GR	2 1/4	22 1/4	C		A	N	261669
									GR	2 1/4	22 1/4	C		A		
MOTOR COACH - MCI																
24	17 1/2	5 3/16	MOTOR COACH IND (MCI)	BUS BRASS FINS	Z	B	7	11	BL	7 3/4	19 1/4	C	26	A	C	282573
									BL	7 3/4	19 1/4	C	26	A		
24 5/8	17 1/2	5 3/16	MOTOR COACH IND (MCI)	BUS BRASS FINS	Z	B	7	11	BL	7 7/8	19 5/8	C	34	A	C	282171
									BL	7 7/8	19 5/8	C	34	A		
24 5/8	17 1/2	6	MOTOR COACH IND (MCI)	BRASS FINS	Z	B	8	10	BL	9 5/8	19 5/8	C	36	A	C	225647
									BL	9 5/8	19 5/8	C	36	A		
MURPHY DIESEL																
32	34 5/16	3 3/4	MURPHY DIESEL	NORTHWEST CRANE, AR-608	T	C	5	7	BL	6 3/4	38	1 3/8	34	J	C	270639
									BL	6 3/4	38	1 3/8	34	J		
MUSTANG																
15 1/4	20 3/8	1 1/4	MUSTANG		VT	C	2	12	BU	3 3/16	20 7/16	C		A	N	124933
									GR	1 5/8	19 13/16	C		A		
16	24 3/16	1 1/4	MUSTANG		VT	C	2	12	GR	2 3/4	23 7/8	C		A	N	122562
									GR	2 3/4	23 7/8	C		A		
16	24 3/16	2	MUSTANG		VT	C	3	12	GR	2 3/4	23 7/8	C		A	N	122578
									GR	2 3/4	23 7/8	C		A		
16 3/8	17 1/16	1 1/4	MUSTANG		VT	C	2	12	BU	3 1/8	17 3/8	C		A	N	122361
									GR	1 5/8	16 3/4	C		A		
16 3/8	20 3/8	1 1/4	MUSTANG		VT	C	2	12	BU	3 3/16	20 7/16	C		A	N	122533
				DIMPLED TUBE					GR	1 5/8	19 13/16	C		A		
16 3/8	20 3/8	1 1/4	MUSTANG		VT	C	2	12	BU	3 3/16	20 7/16	C		A	N	122561
									GR	1 5/8	19 13/16	C		A		
16 1/2	23 1/8	2	MUSTANG		VT	C	3	14	GR	2 7/8	22 5/8	C		A	N	124905
									GR	2 7/8	22 5/8	C		A		
NABI BUS																
36 1/4	33 1/8	3 7/16	NABI BUS		R	C	6	10	BL	7	35	C	44	A	C	225702
									BL	7	35	C	44	A		
38 7/8	14 3/8	3 15/16	NABI BUS		R	C	7	10	BL	6 1/4	15 13/16	C	22	A	C	225704
									BL	6 1/4	15 13/16	C	22	A		
38 7/8	15 5/8	3 15/16	NABI BUS		R	C	7	11	BL	7	17 5/8	C	26	A	C	225703
									BL	7	17 5/8	C	26	A		
NAVISTAR																
20 1/4	23 3/4	1 7/8	NAVISTAR		X	C	2	9	GR	2 1/2	24 1/4	C		A	N	263180
									GR	2 1/2	24 1/4	C		A		
20 1/4	23 3/4	2 1/4	NAVISTAR	A 170,180	X	C	3	11	GR	2 1/2	24	C		A	N	266178
									GR	2 1/2	24	C		A		
20 1/4	24 3/16	2 1/4	NAVISTAR		T	C	3	9	GR	2 1/2	24	C		A	N	261322
									GR	2 1/2	24	C		A		
20 1/2	24 3/16	2 1/4	NAVISTAR		T	C	3	8	GR	3 1/8	24	1/4		A	N	261959
									GR	3 1/8	24	1/4		A		
20 1/2	24 3/16	3	NAVISTAR	K-7	T	C	4	8	GR	3 1/8	24	C		A	N	261960
									GR	3 1/8	24	C		A		
24	21 7/8	2 3/8	NAVISTAR	1810A	S	C	4	11	GR	3 1/2	22 1/2	C		A	C	266421
									GR	3 1/2	22 1/2	C		A		
24	24 3/16	2 1/4	NAVISTAR	A180 SCHOOL BUS	T	C	3	9	GR	2 1/2	24	C		A	C	223275
									GR	2 1/2	24	C		A		

Vista-Pro Automotive - Core Catalog

(Cores Sorted by Application)

Height	Width	Depth	Application	Description	Fin Type	Fin Matl	Rows	FPI	BH / TH Type	BH / TH Width	BH / TH Length	BH / TH OHF	BH / TH Bolts	BH / TH Shape	Hdr Support	Part #
NAVISTAR (Cont)																
24	24 3/16	3	NAVISTAR		T	C	4	11		3 1/8 3 1/8	24 24	C C		0 0	C	263030
24 1/4	25	2 3/8	NAVISTAR	1600	R	C	4	9	GR GR	3 1/2 3 1/2	25 3/4 25 3/4	7/8 7/8		A A	C	226165
24 1/4	25 5/16	3	NAVISTAR	1800 LOADSTAR	T	C	4	11	GR GR	3 1/2 3 1/2	25 3/4 25 3/4	C C		A A	C	264089
24 1/4	25 5/8	2 7/8	NAVISTAR	1700	R	C	5	11	GR GR	3 1/2 3 1/2	25 3/4 25 3/4	C C		A A	C	226629
24 1/4	26 1/4	2 7/8	NAVISTAR	1600-1800	R	C	5	11	GR GR	4 4	26 3/4 26 3/4	C C		A A	C	226166
24 1/4	26 1/4	2 15/16	NAVISTAR	FEED LOT	Z	C	4	7	GR GR	4 4	26 3/4 26 3/4	3/16 3/16		A A	C	286967
24 1/4	26 1/4	3	NAVISTAR		X	C	4	11	GR GR	4 4	26 3/4 26 3/4	1/4 1/4		A A	C	266229
24 1/4	26 1/4	3 3/4	NAVISTAR		X	C	5	11	GR GR	4 4	26 3/4 26 3/4	1/4 1/4		A A	C	266199
24 3/4	23 3/4	2 3/8	NAVISTAR	R190	R	C	4	8		3 1/8 3 1/8	24 24	3/16 3/16		0 0	C	226632
24 3/4	24 3/16	3	NAVISTAR		T	C	4	11	GR GR	3 1/8 3 1/8	24 24	C C		A A	C	223285
24 7/8	21 7/8	1 3/4	NAVISTAR	1700-1800 C/FLO	R	C	3	7	GR GR	2 1/2 2 1/2	22 3/8 22 3/8	3/16 3/16		A A	C	226633
25	21 7/8	2 3/8	NAVISTAR	1800	R	C	4	11	GR GR	3 3/8 3 3/8	22 1/2 22 1/2	1/4 1/4		A A	C	226634
25	21 15/16	2 1/4	NAVISTAR	CO1800	T	C	3	11	GR GR	3 3/8 3 3/8	22 1/2 22 1/2	1/4 1/4		A A	C	264370
26 1/4	26 1/4	2 7/8	NAVISTAR		R	C	5	9	GR GR	4 4	26 7/8 26 7/8	3/16 3/16		A A	C	226635
26 1/4	26 1/4	3 7/16	NAVISTAR	1910B	R	C	6	11	GR GR	3 7/8 3 7/8	26 3/4 26 3/4	3/16 3/16		A A	C	226169
26 1/4	26 7/16	3 3/4	NAVISTAR	CO1910B	T	C	5	11	GR GR	3 7/8 3 7/8	26 3/4 26 3/4	1/4 1/4		A A	C	265621
26 1/2	25 5/16	2 1/4	NAVISTAR	1850 DIESEL	T	C	3	10	GR GR	3 1/2 3 1/2	25 3/4 25 3/4	C C		A A	C	265603
26 1/2	25 5/16	3	NAVISTAR	D1900	T	C	4	10	GR GR	3 1/2 3 1/2	25 3/4 25 3/4	C C		A A	C	264085
26 1/2	25 5/8	1 1/4	NAVISTAR	1700-1800 LOADSTAR	R	C	2	8	GR GR	2 1/2 2 1/2	26 1/4 26 1/4	C C		A A	C	226171
26 1/2	25 5/8	1 3/4	NAVISTAR		R	C	3	11	GR GR	2 1/4 2 1/4	25 3/4 25 3/4	C C		A A	C	226172
26 1/2	25 5/8	1 3/4	NAVISTAR	1600-1800	R	C	3	8	GR GR	2 7/16 2 7/16	26 1/8 26 1/8	7/16 7/16		A A	C	226173
26 1/2	25 5/8	1 3/4	NAVISTAR		S	C	3	10	GR GR	2 1/2 2 1/2	26 1/4 26 1/4	C C		A A	C	266408
26 1/2	25 5/8	2 3/8	NAVISTAR	1850 DIESEL	R	C	4	11	GR GR	3 1/2 3 1/2	25 7/8 25 7/8	C C		A A	C	226636
26 1/2	25 5/8	2 7/8	NAVISTAR		R	C	5	9	GR GR	3 1/2 3 1/2	25 7/8 25 7/8	C C		A A	C	226637
26 1/2	25 7/8	2 1/4	NAVISTAR	1600-1800	T	C	3	11	GR GR	2 1/2 2 1/2	26 1/4 26 1/4	C C		A A	C	263247
26 5/8	25 7/8	2 1/4	NAVISTAR	16001800	T	C	3	11	GR GR	2 7/16 2 7/16	26 1/8 26 1/8	C C		A A	C	274967
26 3/4	25 5/8	1 3/4	NAVISTAR	1700	R	C	3	9	GR GR	3 3	26 26	C C		A A	C	226174

Vista-Pro Automotive - Core Catalog

(Cores Sorted by Application)

Height	Width	Depth	Application	Description	Fin Type	Fin Matl	Rows	FPI	BH / TH Type	BH / TH Width	BH / TH Length	BH / TH OHF	BH / TH Bolts	BH / TH Shape	Hdr Support	Part #
NAVISTAR (Cont)																
26 3/4	26 1/4	2 7/8	NAVISTAR	1800-1900	R	C	5	11	GR GR	3 3/8 3 3/8	26 7/8 26 7/8	3/16 3/16		A A	C	226175
27	25 5/8	2 3/8	NAVISTAR	1800	R	C	4	11	GR GR	3 3	26 26	C C		A A	C	226176
27	26 1/4	2 3/8	NAVISTAR		R	C	4	11	GR GR	3 3	26 1/4 26 1/4	C C		A A	C	226638
27	26 1/4	2 3/8	NAVISTAR	6" X 6" CRANK BOX	R	C	4	11	GR GR	3 3	26 1/4 26 1/4	C C		A A	C	226842
27 1/8	25 7/8	2	NAVISTAR		VT	C	3	11	GR GR	3 1/8 3 1/8	26 1/8 26 1/8	C C		A A	N	124889
28 1/2	25 5/8	2 3/8	NAVISTAR	LOADSTAR	R	C	4	9	GR GR	3 3	26 26	C C		A A	C	226177
28 5/8	26 1/4	2 7/8	NAVISTAR		R	C	5	8	GR GR	4 1/2 4 1/2	26 5/8 26 5/8	7/16 7/16		A A	C	226640
29 5/16	26 7/16	3	NAVISTAR	2010A	T	C	4	10	BL BL	10 6 1/4	28 3/4 28 3/4	1 1/8 1 1/8	42 38	A A	C	264039
29 3/8	26 1/4	2 3/8	NAVISTAR	2050	R	C	4	11	BL BL	6 1/4 6 1/4	28 3/4 28 3/4	1 1/8 1 1/8	38 38	A A	C	226642
29 3/8	26 1/4	2 3/8	NAVISTAR	F2010A	R	C	4	11	BL BL	10 6 1/4	28 3/4 28 3/4	1 1/8 1 1/8	42 38	A A	C	226643
29 3/8	26 1/4	2 7/8	NAVISTAR	2050	R	C	5	11	BL BL	6 1/4 6 1/4	28 3/4 28 3/4	1 1/8 1 1/8	38 38	A A	C	226178
29 3/8	26 1/4	2 7/8	NAVISTAR	2010A	R	C	5	10	BL BL	10 6 1/4	28 3/4 28 3/4	1 1/8 1 1/8	42 38	A A	C	226641
29 3/8	26 7/16	3	NAVISTAR	F2010 HVY BTM HDR	T	C	4	9	BL BH	10 6 1/4	28 3/4 28 3/4	1 1/4 1 1/4	42 38	A A	C	223276
29 3/8	26 7/16	3	NAVISTAR		T	C	4	9	BL BL	6 1/4 6 1/4	28 3/4 28 3/4	1 1/4 1 1/4	38 38	A A	C	277959
29 1/2	22 5/16	2 1/4	NAVISTAR	SEE 251132	VTH	C	3	15	BL BL	6 1/4 6 1/4	25 1/4 25 1/4	2 1/2 2 1/2	36 36	A A	N	252132
29 1/2	22 1/2	2 1/4	NAVISTAR	9700 SERIES 1652622-C94, 1651979-C93 CAN USE 226645	VH	C	3	15	BL BL	6 1/4 6 1/4	25 1/4 25 1/4	2 1/2 2 1/2	36 36	A A	N	251132
29 1/2	22 1/2	2 3/8	NAVISTAR	9700 SERIES 1652622-C94	R	C	4	11	BL BL	6 1/4 6 1/4	25 1/4 25 1/4	2 1/2 2 1/2	36 36	A A	C	226645
29 3/4	25 5/8	2 1/4	NAVISTAR		VE	C	4	15	GR GR	3 1/8 3 1/8	26 5/8 26 5/8	C C		A A	N	128200
29 3/4	25 5/8	1 3/4	NAVISTAR		R	C	3	8	GR GR	3 1/8 3 1/8	26 1/4 26 1/4	C C		A A	C	226179
29 3/4	25 5/8	2 3/8	NAVISTAR	DT466 4900	R	C	4	11	GR GR	3 1/8 3 1/8	26 5/8 26 5/8	C C		A A	C	226803
29 3/4	25 5/8	2 3/8	NAVISTAR	WITH PTO	R	C	4	11	GR GR	3 1/8 3 1/8	26 5/8 26 5/8	C C		A A	C	226862
29 3/4	25 7/8	2	NAVISTAR		VT	C	3	14	GR GR	2 7/8 2 7/8	26 1/4 26 1/4	C C		A A	N	129021
29 3/4	25 7/8	2	NAVISTAR		VT	C	3	14	GR GR	2 7/8 2 7/8	26 1/4 26 1/4	C C		A A	N	129027
30 1/4	29 1/4	2 1/4	NAVISTAR	TEMPLATE #15	T	C	3	10	BL BL	10 1/4 6 7/8	31 1/4 31 1/4	2 1/4 2 1/4	54 40	A A	C	277429
30 1/4	29 3/8	1 3/4	NAVISTAR	TEMPLATE #14A	R	C	3	11	BL BL	10 1/4 6 7/8	31 1/4 31 1/4	1 5/8 1 5/8	54 40	A A	C	226651
30 1/4	29 3/8	1 3/4	NAVISTAR	TEMPLATE #18A	R	C	3	11	BL BL	10 1/4 6 7/8	31 1/4 31 1/4	1 5/8 1 5/8	54 40	A A	C	226889
30 1/4	29 3/8	2 3/8	NAVISTAR	5000 PAYSTAR TEMPLATE #14	R	C	4	11	BL BL	10 1/4 6 7/8	31 1/4 31 1/4	1 5/8 1 5/8	54 40	A A	C	226652

Vista-Pro Automotive - Core Catalog

(Cores Sorted by Application)

Height	Width	Depth	Application	Description	Fin Type	Fin Matl	Rows	FPI	BH/TH Type	BH/TH Width	BH/TH Length	BH/TH OHF	BH/TH Bolts	BH/TH Shape	Hdr Support	Part #	
NAVISTAR (Cont)																	
30	1/4	29 3/8	2 3/8	NAVISTAR	5000 PAYSTAR TEMPLATE #15	R	C	4	11	BL BL	10 1/4 6 7/8	31 1/4 31 1/4	1 5/8 1 5/8	54 40	A A	C	226653
30	1/4	29 3/8	2 7/8	NAVISTAR	5070 PAYSTAR TEMPLATE #12	R	C	5	11	BL BL	10 1/4 6 7/8	31 1/4 31 1/4	2 C	54 40	A A	C	226648
30	1/4	29 3/8	2 7/8	NAVISTAR	5070 PAYSTAR TEMPLATE #14A	R	C	5	11	BL BL	10 1/4 6 7/8	31 1/4 31 1/4	2 C	54 40	A A	C	226649
30	1/4	29 3/8	2 7/8	NAVISTAR	5000 PAYSTAR TEMPLATE #14	R	C	5	11	BL BL	10 1/4 6 7/8	31 1/4 31 1/4	1 7/8 1 7/8	54 40	A A	C	226650
30	1/4	29 3/8	3 7/16	NAVISTAR	5070 PAYSTAR TEMPLATE #14	R	C	6	11	BL BL	10 1/4 6 7/8	31 1/4 31 1/4	1 5/8 1 5/8	54 40	A A	C	226181
31		12 1/8	2	NAVISTAR		VT	C	3	15	GR GR	3 3	26 1/4 26 1/4	C C		A A	N	124033
31		12 1/8	2 5/8	NAVISTAR		VT	C	4	14	GR GR	3 1/8 3 1/8	26 5/8 26 5/8	C C		A A	N	124041
31		25 5/8	1 3/4	NAVISTAR	2050	R	C	3	8	GR GR	3 1/8 3 1/8	26 1/4 26 1/4	C C		A A	C	226184
31		25 5/8	1 3/4	NAVISTAR	2050 6 X 6 1/2" CRANK BOX	R	C	3	8	GR GR	3 1/8 3 1/8	26 1/4 26 1/4	C C		A A	C	226847
31		25 5/8	2 3/8	NAVISTAR	AT190	R	C	4	11	GR GR	3 1/8 3 1/8	26 1/4 26 1/4	C C		A A	C	226185
31		25 5/8	2 3/8	NAVISTAR	DT466 1900	R	C	4	11	GR GR	3 1/8 3 1/8	26 5/8 26 5/8	C C		A A	C	226802
31		25 5/8	2 3/8	NAVISTAR	6" X 6 1/2" CRANK BOX	R	C	4	11	GR GR	3 1/8 3 1/8	26 1/4 26 1/4	C C		A A	C	226819
31		25 5/8	2 3/8	NAVISTAR	WITH PTO	R	C	4	11	GR GR	3 1/8 3 1/8	26 5/8 26 5/8	C C		A A	C	226861
31		25 5/8	2 15/16	NAVISTAR	FEED LOT	Z	C	4	9	GR GR	3 1/8 3 1/8	26 1/4 26 1/4	C C		A A	C	281589
31		25 7/8	2	NAVISTAR		VT	C	3	12	GR GR	3 1/8 3 1/8	26 5/8 26 5/8	3/8 3/8		A A	N	124061
31		25 7/8	2	NAVISTAR		VT	C	3	16	GR GR	3 3	26 26	C C		A A	N	122700
31		25 7/8	2	NAVISTAR		VT	C	3	16	GR GR	3 1/8 3 1/8	26 1/4 26 1/4	C C		A A	N	122711
31		25 7/8	2 5/8	NAVISTAR	CRANK BOX	VT	C	4	12	GR GR	3 1/8 3 1/8	26 1/4 26 1/4	C C		A A	N	124831
31		25 7/8	2 5/8	NAVISTAR		VT	C	4	14	GR GR	3 1/8 3 1/8	26 1/4 26 1/4	C C		A A	N	128507
31		26	1 9/16	NAVISTAR		VE	C	3	14	GR GR	3 1/8 3 1/8	26 5/8 26 5/8	3/8 3/8		A A	N	128865
31		26 3/8	2 5/8	NAVISTAR		VT	C	4	12	GR GR	3 1/8 3 1/8	26 5/8 26 5/8	C C		A A	N	122218
31	5/16	12 1/4	2 1/4	NAVISTAR		VTH	C	3	14	GR GR	2 7/8 2 7/8	26 1/4 26 1/4	C C		A A	N	254033
31	1/2	28 1/8	2 7/8	NAVISTAR		R	C	5	11	BL BL	6 1/8 6 1/8	31 1/2 31 1/2	1 1/8 1 1/8	42 42	A A	C	226654
31	3/4	27 9/16	3	NAVISTAR	2000 FLEETSTAR TEMPLATE #18	T	C	4	10	BL BL	10 1/8 6	29 1/2 29 1/2	1 1/4 1 1/4	42 40	A A	C	223294
31	7/8	27 9/16	3	NAVISTAR		T	C	4	10	BL BL	10 1/8 6 1/8	29 1/2 29 1/2	1 1/8 1 1/8	42 40	A A	C	265577
32	3/16	25 1/2	3	NAVISTAR	S SERIES LOW FLOW CAN USE 284694 DIMPLED TUBE	VH	C	4	15	BL BL	6 1/8 6 1/8	27 1/2 27 1/2	1 3/8 1 3/8	38 38	A A	N	251014
32	3/16	25 1/2	3	NAVISTAR	E-2511-3	VH	C	4	16	BL BL	6 1/8 6 1/8	27 1/2 27 1/2	1 1/4 1 1/4	38 38	A A	N	251133

Vista-Pro Automotive - Core Catalog

(Cores Sorted by Application)

Height	Width	Depth	Application	Description	Fin Type	Fin Matl	Rows	FPI	BH/TH Type	BH/TH Width	BH/TH Length	BH/TH OHF	BH/TH Bolts	BH/TH Shape	Hdr Support	Part #
NAVISTAR (Cont)																
32	3/16	25 5/8	2 7/8	NAVISTAR	S SERIES LOW FLOW CAN USE 284694 DIMPLED TUBE	R	C	5	11	BL BL	6 1/8 27 1/2	27 1/2	1 3/8 38	A A	C	226003
32	3/16	25 5/8	2 7/8	NAVISTAR	E-2511-3	R	C	5	11	BL BL	6 1/8 27 1/2	27 1/2	1 1/4 38	A A	C	226890
32	3/16	26 1/4	3	NAVISTAR	ULTRA-FUSED LOW FLOW CAN USE 251014 DIMPLED TUBE	VH	C	4	16	BL BL	6 1/8 27 1/2	27 1/2	1 3/8 38	A A	N	284694
32	1/4	25 5/8	2 3/8	NAVISTAR	2000	R	C	4	11	BL BL	6 1/8 27 1/2	27 1/2	1 1/4 38	A A	C	226657
33		29 3/8	2 3/8	NAVISTAR		R	C	4	11	BL BL	6 30 3/4	30 3/4	1 3/8 40	A A	C	226162
33	1/2	26 1/4	2 1/4	NAVISTAR		X	C	3	10	BL BL	6 1/4 28 3/4	28 3/4	1 1/8 38	A A	C	266036
33	1/2	26 7/16	3	NAVISTAR		T	C	4	9	BL BL	6 1/4 28 3/4	28 3/4	1 1/4 38	A A	C	223295
33	5/8	26 1/4	2 3/8	NAVISTAR		R	C	4	10	BL BL	6 1/4 28 3/4	28 3/4	1 1/8 38	A A	C	226658
33	5/8	26 1/4	2 7/8	NAVISTAR		R	C	5	11	BL BL	10 28 3/4	28 3/4	1 1/8 42	A A	C	226190
33	5/8	26 1/4	2 7/8	NAVISTAR	2070	R	C	5	10	BL BL	6 1/4 28 3/4	28 3/4	1 1/8 38	A A	C	226191
33	5/8	26 1/4	2 7/8	NAVISTAR	6 1/4" X 9" CRANK BOX	R	C	5	11	BL BL	6 1/8 28 3/4	28 3/4	1 1/8 38	A A	C	226832
34		29 1/4	3	NAVISTAR	DC400 TEMPLATE #16	T	C	4	10	BL BL	10 3/8 31 1/4	31 1/4	1 1/2 44	A A	C	263940
34		29 3/8	2 3/8	NAVISTAR	TEMPLATE #17	R	C	4	10	BL BL	10 3/8 31 1/4	31 1/4	1 3/8 44	A A	C	226661
34	13/16	23 5/8	3	NAVISTAR		T	C	4	11	BL BL	8 3/8 26	26	1 1/2 46	A A	C	263283
34	13/16	23 5/8	3 3/4	NAVISTAR	DCF405	T	C	5	9	BL BL	8 3/8 26	26	1 1/2 46	A A	C	275223
37	1/8	39 15/16	3	NAVISTAR	4300 TRANSTAR CONVENTIONAL HVY BTM HDR	T	C	4	11	BL BH	6 11/16 43 1/8	43 1/8	2 1/8 64	B B	C	223303
37	1/8	40	2 3/8	NAVISTAR	4300 TRANSTAR HVY BTM HDR	R	C	4	9	BL BH	6 11/16 43 1/8	43 1/8	2 1/8 64	B B	C	226671
37	1/8	40	2 7/8	NAVISTAR	4300 TRANSTAR HVY BTM HDR	R	C	5	11	BL BH	6 11/16 43 1/8	43 1/8	2 1/8 64	B B	C	226670
37	1/8	40	3 7/16	NAVISTAR	4300 TRANSTAR HVY BTM HDR	R	C	6	11	BL BH	6 11/16 43 1/8	43 1/8	1 7/8 64	B B	C	226672
37	3/16	32 1/2	2 3/8	NAVISTAR	4270 TRANSTAR	R	C	4	9	BL BL	6 11/16 35 1/2	35 1/2	C 54	B B	C	226674
37	3/16	32 1/2	2 7/8	NAVISTAR	4270 TRANSTAR 441829-C1 HVY BTM HDR	R	C	5	11	BL BH	6 11/16 35 1/2	35 1/2	C 54	B B	C	226673
37	3/16	32 1/2	3	NAVISTAR	4270 TRANSTAR	VH	C	4	14	BL BL	6 11/16 35 1/2	35 1/2	C 54	B B	N	251109
37	3/16	32 5/8	3	NAVISTAR	4270 TRANSTAR HVY BTM HDR	T	C	4	9	BL BH	6 11/16 35 1/2	35 1/2	1 11/16 54	B B	C	223302
37	5/8	25	2 3/8	NAVISTAR		R	C	4	11	BL BL	6 1/8 27 1/2	27 1/2	C 38	A A	C	226138
37	5/8	25 1/16	2 1/4	NAVISTAR	ULTRA-FUSED CAN USE 226138	VH	C	3	16	BL BL	6 1/8 27 1/2	27 1/2	C 38	A A	N	284826
38		26 1/4	2 3/8	NAVISTAR	4070A TEMPLATE #13	S	C	4	10	BL BL	12 1/8 28 7/8	28 7/8	2 1/4 58	F A	C	266417

Vista-Pro Automotive - Core Catalog

(Cores Sorted by Application)

Height	Width	Depth	Application	Description	Fin Type	Fin Matl	Rows	FPI	BH/TH Type	BH/TH Width	BH/TH Length	BH/TH OHF	BH/TH Bolts	BH/TH Shape	Hdr Support	Part #
NAVISTAR (Cont)																
38	26 1/4	2 7/8	NAVISTAR	4070A TEMPLATE #13	R	C	5	10	BL BL	12 1/8 6 7/8	28 7/8 28 7/8	2 1/4 1 3/8	58 50	F B	C	226676
38	29 3/8	2 3/8	NAVISTAR	TEMPLATE #15	R	C	4	11	BL BL	10 1/4 6 7/8	31 1/4 31 1/4	2 1/8 2 1/8	54 40	A A	C	226680
38	29 3/8	2 7/8	NAVISTAR	5000 PAYSTAR TEMPLATE #12	R	C	5	11	BL BL	10 1/4 6 7/8	31 1/4 31 1/4	2 C	54 40	A A	C	226195
38	29 3/8	2 7/8	NAVISTAR	5000 PAYSTAR TEMPLATE #15	R	C	5	11	BL BL	10 1/4 6 7/8	31 1/4 31 1/4	1 7/8 1 7/8	54 40	A A	C	226681
38	29 3/8	3 7/16	NAVISTAR	5000 PAYSTAR TEMPLATE #12	R	C	6	11	BL BL	10 1/4 6 7/8	31 1/4 31 1/4	1 1/2 1 1/2	54 40	A A	C	226196
38	29 3/8	3 7/16	NAVISTAR	PAYSTAR TEMPLATE #15	R	C	6	11	BL BL	10 1/4 6 7/8	31 1/4 31 1/4	1 1/2 1 1/2	54 40	A A	C	226678
39 3/4	29 13/16	2 1/4	NAVISTAR	F2275 HVY BTM HDR	T	C	3	11	BL BH	6 3/4 6 3/4	32 1/8 32 1/8	1 3/4 1 3/4	38 38	A A	C	265588
39 3/4	29 7/8	1 1/2	NAVISTAR	SEE 251112	VTH	C	2	16	BL BL	6 3/4 6 3/4	32 1/8 32 1/8	1 3/4 1 3/4	38 38	A A	N	253112
39 3/4	29 7/8	1 1/2	NAVISTAR	SEE 251035 DIMPLED TUBE	VTH	C	2	16	BL BL	6 3/4 6 3/4	32 1/8 32 1/8	1 3/4 1 3/4	38 38	A A	N	253035
39 3/4	29 7/8	2 1/4	NAVISTAR	SEE 251112	VTH	C	3	14	BL BL	6 3/4 6 3/4	32 1/8 32 1/8	1 3/4 1 3/4	38 38	A A	N	252112
39 3/4	29 7/8	2 1/4	NAVISTAR	SEE 251035 DIMPLED TUBE	VTH	C	3	15	BL BL	6 3/4 6 3/4	32 1/8 32 1/8	1 3/4 1 3/4	38 38	A A	N	252035
39 3/4	29 7/8	2 1/4	NAVISTAR	SEE 251116	VTH	C	3	14	BL BL	6 3/4 6 3/4	32 1/8 32 1/8	1 3/4 1 3/4	38 38	A A	N	252112
39 3/4	29 7/8	2 1/4	NAVISTAR	SEE 251024 DIMPLED TUBE	VTH	C	3	15	BL BL	6 3/4 6 3/4	32 1/8 32 1/8	C C	38 38	A A	N	252035
39 3/4	29 7/8	3	NAVISTAR	SEE 251116	VTH	C	4	14	BL BL	6 3/4 6 3/4	32 1/8 32 1/8	1 3/4 1 3/4	38 38	A A	N	253116
39 3/4	29 7/8	3	NAVISTAR	SEE 251024 DIMPLED TUBE	VTH	C	4	15	BL BL	6 3/4 6 3/4	32 1/8 32 1/8	C C	38 38	A A	N	252024
39 3/4	30	1 1/2	NAVISTAR	S SERIES	VH	C	2	14	BL BL	6 3/4 6 3/4	32 1/8 32 1/8	1 3/4 1 3/4	38 38	A A	N	251114
39 3/4	30	2 1/4	NAVISTAR	S SERIES CAN USE 226140	VH	C	3	14	BL BL	6 3/4 6 3/4	32 1/8 32 1/8	1 3/4 1 3/4	38 38	A A	N	251112
39 3/4	30	2 1/4	NAVISTAR	S SERIES LOW FLOW CAN USE 284015 DIMPLED TUBE	VH	C	3	15	BL BL	6 3/4 6 3/4	32 1/8 32 1/8	1 3/4 1 3/4	38 38	A A	N	251035
39 3/4	30	2 3/8	NAVISTAR	S SERIES LOW FLOW CAN USE 284015 DIMPLED TUBE	R	C	4	11	BL BL	6 3/4 6 3/4	32 1/4 32 1/4	1 11/16 1 11/16	38 38	A A	C	226034
39 3/4	30	2 3/8	NAVISTAR	S SERIES	R	C	4	11	BL BL	6 3/4 6 3/4	32 1/8 32 1/8	1 3/4 1 3/4	38 38	A A	C	226140
39 3/4	30	2 7/8	NAVISTAR	S SERIES LOW FLOW CAN USE 284078 DIMPLED TUBE	R	C	5	11	BL BL	6 3/4 6 3/4	32 1/8 32 1/8	C C	38 38	A A	C	226017
39 3/4	30	2 7/8	NAVISTAR	S SERIES	R	C	5	11	BL BL	6 3/4 6 3/4	32 1/8 32 1/8	1 5/8 1 5/8	38 38	A A	C	226142
39 3/4	30	3	NAVISTAR	S SERIES CAN USE 226142	VH	C	4	14	BL BL	6 3/4 6 3/4	32 1/8 32 1/8	1 3/4 1 3/4	38 38	A A	N	251116
39 3/4	30	3	NAVISTAR	S SERIES LOW FLOW CAN USE 284078 DIMPLED TUBE	VH	C	4	15	BL BL	6 3/4 6 3/4	32 1/8 32 1/8	C C	38 38	A A	N	251024
39 3/4	30 3/16	2 1/4	NAVISTAR	S SERIES ULTRA-FUSED LOW FLOW CAN USE 251035 DIMPLED TUBE	VH	C	3	14	BL BL	6 3/4 6 3/4	32 1/8 32 1/8	1 3/4 1 3/4	38 38	A A	N	284015
39 3/4	30 3/16	2 1/4	NAVISTAR	S SERIES ULTRA-FUSED CAN USE 226140 OR 251112	VH	C	3	14	BL BL	6 3/4 6 3/4	32 1/8 32 1/8	1 3/4 1 3/4	38 38	A A	N	284804
39 3/4	30 3/16	3	NAVISTAR	S SERIES ULTRA-FUSED LOW FLOW CAN USE 251024 DIMPLED TUBE	VH	C	4	14	BL BL	6 3/4 6 3/4	32 1/8 32 1/8	C C	38 38	A A	N	284078

Vista-Pro Automotive - Core Catalog

(Cores Sorted by Application)

Height	Width	Depth	Application	Description	Fin Type	Fin Matl	Rows	FPI	BH / TH Type	BH / TH Width	BH / TH Length	BH / TH OHF	BH / TH Bolts	BH / TH Shape	Hdr Support	Part #
NAVISTAR (Cont)																
39 3/4	30 3/16	3	NAVISTAR	S SERIES ULTRA-FUSED CAN USE 226142 OR 251116	VH	C	4	14	BL BL	6 3/4 6 3/4	32 1/8 32 1/8	1 3/4 1 3/4	38 38	A A	N	284740
39 7/8	27 5/16	2 1/4	NAVISTAR	9370, 9670 ULTRA-FUSED CAN USE 226893	VH	C	3	14	BL BL	6 6	30 3/4 30 3/4	C C	40 40	A A	N	284693
39 7/8	28 1/2	2 1/4	NAVISTAR	9370, 9670 ULTRA-FUSED LOW FLOW CAN USE 251036 DIMPLED TUBE	VH	C	3	14	BL BL	6 6	30 3/4 30 3/4	C C	40 40	A A	N	284035
39 7/8	28 1/2	3	NAVISTAR	9370, 9670 ULTRA-FUSED CAN USE 226684	VH	C	4	11	BL BL	6 6	30 3/4 30 3/4	C C	40 40	A A	N	284305
39 7/8	28 1/2	3	NAVISTAR	9370, 9670 ULTRA-FUSED LOW FLOW CAN USE 251021 DIMPLED TUBE	VH	C	4	14	BL BL	6 6	30 3/4 30 3/4	C C	40 40	A A	N	284703
39 7/8	35 15/16	2 1/4	NAVISTAR	9370, 9670 ULTRA-FUSED CAN USE 226146	VH	C	3	13	BL BL	6 6	38 1/8 38 1/8	C C	48 48	A A	N	284315
39 7/8	35 15/16	3	NAVISTAR	9370, 9670 573101-C91 ULTRA-FUSED LOW FLOW CAN USE 251028 DIMPLED TUBE	VH	C	4	13	BL BL	6 6	38 1/8 38 1/8	C C	48 48	A A	N	284692
39 15/16	28	2 1/4	NAVISTAR	9370, 9670 CAN USE 226893	VH	C	3	14	BL BL	6 6	30 3/4 30 3/4	C C	40 40	A A	N	251120
39 15/16	28	2 1/4	NAVISTAR	9370, 9670 LOW FLOW CAN USE 284035 DIMPLED TUBE	VH	C	3	15	BL BL	6 6	30 3/4 30 3/4	C C	40 40	A A	N	251036
39 15/16	28	3	NAVISTAR	9370, 9670 CAN USE 226197	VH	C	4	14	BL BL	6 6	30 3/4 30 3/4	C C	40 40	A A	N	251113
39 15/16	28	3	NAVISTAR	9360, 9670 LOW FLOW CAN USE 284703 DIMPLED TUBE	VH	C	4	15	BL BL	6 6	30 3/4 30 3/4	C C	40 40	A A	N	251021
39 15/16	28 1/8	1 3/4	NAVISTAR	9670	R	C	3	11	BL BL	6 6	30 3/4 30 3/4	C C	40 40	A A	C	226683
39 15/16	28 1/8	2 3/8	NAVISTAR	9370, 9670 LOW FLOW CAN USE 284035 DIMPLED TUBE	R	C	4	11	BL BL	6 6	30 3/4 30 3/4	C C	40 40	A A	C	226035
39 15/16	28 1/8	2 7/8	NAVISTAR	9360, 9670 LOW FLOW CAN USE 284703 DIMPLED TUBE	R	C	5	11	BL BL	6 6	30 3/4 30 3/4	C C	40 40	A A	C	226013
39 15/16	28 1/8	2 7/8	NAVISTAR	9670 CAN USE 284305	R	C	5	10	BL BL	6 6	30 3/4 30 3/4	1 1/2 1 1/2	40 40	A A	C	226684
39 15/16	28 3/16	2 1/4	NAVISTAR	SEE 251021 DIMPLED TUBE	VTH	C	3	16	BL BL	6 6	30 3/4 30 3/4	C C	40 40	A A	N	253021
39 15/16	29 3/8	2 3/8	NAVISTAR	9370, 9670	R	C	4	11	BL BL	6 6	30 3/4 30 3/4	C C	40 40	A A	C	226144
39 15/16	29 3/8	2 7/8	NAVISTAR	9670	R	C	5	11	BL BL	6 6	30 3/4 30 3/4	C C	40 40	A A	C	226197
39 15/16	35 3/8	2 1/4	NAVISTAR	SEE 251028 DIMPLED TUBE	VTH	C	3	16	BL BL	6 6	38 1/8 38 1/8	C C	48 48	A A	N	253028
39 15/16	35 3/8	3	NAVISTAR	SEE 251028 DIMPLED TUBE	VTH	C	4	15	BL BL	6 6	38 1/8 38 1/8	C C	48 48	A A	N	252028
39 15/16	35 1/2	3	NAVISTAR	9370, 9670 LOW FLOW DIMPLED TUBE	VH	C	4	15	BL BL	6 6	38 1/8 38 1/8	C C	48 48	A A	N	251028
39 15/16	35 5/8	2 3/8	NAVISTAR	9370, 9670	R	C	4	11	BL BL	6 6	38 1/8 38 1/8	1 7/16 1 7/16	48 48	A A	C	226146
39 15/16	35 5/8	2 7/8	NAVISTAR	9370, 9670 LOW FLOW DIMPLED TUBE	R	C	5	11	BL BL	6 6	38 1/8 38 1/8	C C	48 48	A A	C	226023
39 15/16	35 5/8	2 7/8	NAVISTAR	9370, 9670	R	C	5	11	BL BL	6 6	38 1/8 38 1/8	1 5/8 1 5/8	48 48	A A	C	226685
41	29 1/4	3	NAVISTAR	TRANSTAR HVY BTM HDR	T	C	4	11	BL BH	9 1/2 8 1/8	31 3/4 31 3/4	2 1/2 1 7/8	40 40	F F	C	265514
41	29 1/4	3 3/4	NAVISTAR	TRANSTAR 318 HVY BTM HDR	T	C	5	11	BL BH	9 1/2 8 1/8	31 3/4 31 3/4	2 1/2 1 13/16	40 40	F F	C	265515

Vista-Pro Automotive - Core Catalog

(Cores Sorted by Application)

Height	Width	Depth	Application	Description	Fin Type	Fin Matl	Rows	FPI	BH/TH Type	BH/TH Width	BH/TH Length	BH/TH OHF	BH/TH Bolts	BH/TH Shape	Hdr Support	Part #
NAVISTAR (Cont)																
41	29 3/8	2 3/8	NAVISTAR	4070B CAN USE 281921	R	C	4	11	BL	9 1/2	31 3/4	2 1/2	40	F	C	226198
									BL	8 1/8	31 3/4	1 3/4	40	F		
41	29 3/8	2 7/8	NAVISTAR	4070B TRANSTAR	R	C	5	11	BL	9 1/2	31 3/4	2 1/2	40	F	C	226247
									BL	8 1/8	31 3/4	2	40	F		
41	29 3/8	3 7/16	NAVISTAR	4070B HVY BTM HDR	R	C	6	11	BL	9 1/2	31 3/4	2 1/2	40	F	C	226687
									BH	8 1/8	31 3/4	1 7/8	40	F		
41	29 1/2	3	NAVISTAR	4070-B CAN USE 226247	VH	C	4	14	BL	9 1/2	31 3/4	2 1/2	40	F	N	251117
									BL	8 1/8	31 3/4	2	40	F		
42 3/4	27 15/16	2 1/4	NAVISTAR	9400 ULTRA-FUSED CAN USE 251121	VH	C	3	13	BL	6	31 1/4	C	42	B	N	284010
									BL	6	31 1/4	C	42	B		
42 3/4	27 15/16	3	NAVISTAR	ULTRA-FUSED LOW FLOW CAN USE 251007	VH	C	4	14	BL	6	31 1/4	C	42	B	N	284715
				DIMPLED TUBE					BL	6	31 1/4	C	42	B		
42 3/4	28	2 1/4	NAVISTAR	9400 CAN USE 284010	VH	C	3	14	BL	6	31 1/4	C	42	B	N	251121
									BL	6	31 1/4	C	42	B		
42 3/4	28	2 1/4	NAVISTAR	9400 LOW FLOW	VH	C	3	15	BL	6	31 1/4	C	42	B	N	251037
				DIMPLED TUBE					BL	6	31 1/4	C	42	B		
42 3/4	28	3	NAVISTAR	9400 E2590-2	VH	C	4	14	BL	6	31 1/4	C	42	B	N	251124
									BL	6	31 1/4	C	42	B		
42 3/4	28	3	NAVISTAR	9400 SERIES LOW FLOW CAN USE 284715	VH	C	4	15	BL	6	31 1/4	C	42	B	N	251007
				DIMPLED TUBE					BL	6	31 1/4	C	42	B		
42 3/4	28 1/8	2 3/8	NAVISTAR	9400 LOW FLOW	R	C	4	11	BL	6	31 1/4	C	42	B	C	226036
				DIMPLED TUBE					BL	6	31 1/4	C	42	B		
42 3/4	28 1/8	2 3/8	NAVISTAR	9400	R	C	4	11	BL	6	31 1/4	C	42	B	C	226147
									BL	6	31 1/4	C	42	B		
42 3/4	28 1/8	2 7/8	NAVISTAR	9400 SERIES LOW FLOW CAN USE 284715	R	C	5	11	BL	6	31 1/4	C	42	B	C	226026
				DIMPLED TUBE					BL	6	31 1/4	C	42	B		
42 3/4	28 1/8	2 7/8	NAVISTAR		R	C	5	11	BL	6	31 1/4	C	42	F	C	226851
									BL	6	31 1/4	C	42	F		
42 3/4	28 1/8	2 7/8	NAVISTAR	9400 SERIES	R	C	5	11	BL	6	31 1/4	C	42	B	C	226844
									BL	6	31 1/4	C	42	B		
42 3/4	28 3/16	1 1/2	NAVISTAR	SEE 251121	VTH	C	2	16	BL	6	31 1/4	C	42	B	N	253121
									BL	6	31 1/4	C	42	B		
42 3/4	28 3/16	2 1/4	NAVISTAR	SEE 251121	VTH	C	3	14	BL	6	31 1/4	C	42	B	N	252121
									BL	6	31 1/4	C	42	B		
42 3/4	28 3/16	2 1/4	NAVISTAR	SEE 251007	VTH	C	3	16	BL	6	31 1/4	C	42	B	N	253007
				DIMPLED TUBE					BL	6	31 1/4	C	42	B		
42 3/4	28 3/16	3	NAVISTAR	SEE 251007	VTH	C	4	15	BL	6	31 1/4	C	42	B	N	252007
				DIMPLED TUBE					BL	6	31 1/4	C	42	B		
43 3/4	29 3/8	3 7/16	NAVISTAR	PAYSTAR HVY T/BTM HDRS	R	C	6	11	BH	10 1/4	31 1/4	1 5/8	54	A	C	226691
				TEMPLATE #14					BH	6 7/8	31 1/4	1 5/8	40	A		
44	29 3/8	3 7/16	NAVISTAR	5050 PAYSTAR HVY BTM HDR	R	C	6	11	BL	10 1/4	31 1/4	1 1/2	54	A	C	226693
				TEMPLATE #15					BH	6 7/8	31 1/4	1 1/2	40	A		
NEOPLAN BUS																
34 1/4	35	3 7/16	NEOPLAN BUS	W/6V-92 DETROIT DIESEL	R	C	6	10	BL	6 5/8	37	C	44	A	C	226697
									BL	6 5/8	37	C	44	A		
NEW FLYER BUS																
36 1/4	20	4 7/16	NEW FLYER BUS	BUS; OE 6328843	R	C	8	10	BH	8 1/2	21 3/4	C	32	A	C	223631
									BH	8 1/2	21 3/4	C	32	A		
NISSAN																
10 3/4	19 1/4	1 1/4	NISSAN		VT	C	2	12	BU	3	19 7/16	C		A	N	124611
									GR	2 1/8	19 5/8	C		A		
10 3/4	19 1/4	2	NISSAN		VT	C	3	14	BU	3	19 7/16	C		A	N	124934
									GR	2 1/4	19 1/4	C		A		

Vista-Pro Automotive - Core Catalog

(Cores Sorted by Application)

Height	Width	Depth	Application	Description	Fin Type	Fin Matl	Rows	FPI	BH/TH Type	BH/TH Width	BH/TH Length	BH/TH OHF	BH/TH Bolts	BH/TH Shape	Hdr Support	Part #
NISSAN(Cont)																
10 3/4	19 1/4	2	NISSAN		VT	C	3	14	BU FR	3 2 1/8	19 7/16 19 1/4	C C		A A	N	124951
13	17 5/8	1 1/4	NISSAN		VT	C	2	12	GR GR	2 1/2 2	18 18	3/16 C		A A	N	124680
13	18 1/8	1 1/4	NISSAN		VT	C	2	15	GR GR	2 1/2 2	18 18	C C		A A	N	124843
13	18 11/16	1 1/4	NISSAN		VT	C	2	14	GR GR	1 7/8 1 7/8	18 7/8 18 7/8	C C		A A	N	122291
13 1/8	25 5/16	2	NISSAN		VT	C	3	14	GR GR	2 1/2 2 1/2	25 5/8 25 5/8	C C		A A	N	128152
13 1/2	19 13/16	1 1/4	NISSAN		VT	C	2	12	GR GR	2 2	19 5/8 19 5/8	C C		A A	N	128453
14 1/8	21 7/16	2	NISSAN		VT	C	3	12	GR FR	2 5/8 2 1/16	21 3/4 21 3/4	C C		A A	N	128442
14 1/8	25 5/16	1 1/4	NISSAN		VT	C	2	12	GR GR	1 13/16 1 13/16	25 3/4 25 3/4	C C		A A	N	128759
14 1/4	14 5/16	2	NISSAN		VT	C	3	12	GR GR	3 1/8 2 1/4	15 3/8 14 7/8	C C		A A	N	128671
14 1/4	15 3/8	2	NISSAN		VT	C	3	12	GR GR	3 2 1/4	15 1/4 15 1/4	FF C		A A	N	124614
14 3/8	24 3/16	1 1/4	NISSAN		VT	C	2	12	GR GR	2 5/8 2 7/16	24 1/2 24 1/2	C C		0 A	N	124950
16 1/8	24 3/16	2 5/8	NISSAN		VT	C	4	12	GR GR	2 7/8 2 7/8	24 3/8 24 3/8	C C		A A	N	128511
16 1/8	25 5/16	1 1/4	NISSAN		VT	C	2	12	GR GR	1 13/16 1 13/16	25 13/16 25 13/16	C C		A A	N	128773
21 5/8	23 5/8	2	NISSAN UD TRUCK		VT	C	3	12	GR GR	2 1/2 2 1/2	24 1/8 24 1/8	C C		A A	N	124037
26 1/4	13 3/16	1 1/4	NISSAN-STANZA		VT	C	2	15	GR GR	1 7/8 1 7/8	13 13	C C		A A	N	128702
NOVA BUS																
30	16 7/8	3 7/16	NOVA BUS	G1050366 DIMPLED TUBES DIMPLED TUBE	S	C	6	11	BL BL	6 1/4 6 1/4	18 1/2 18 1/2	C C	28 28	A A	C	229205
OLDSMOBILE																
15 1/2	25 5/16	1 1/4	OLDSMOBILE		VT	C	2	12	GR GR	3 2 3/4	25 7/16 25 7/16	C C		A A	N	122480
15 1/2	25 5/16	2 5/8	OLDSMOBILE		VT	C	4	12	GR GR	3 3/8 3 3/8	25 7/16 25 7/16	C C		A A	N	122389
17 3/8	25 5/16	2 5/8	OLDSMOBILE		VT	C	4	12	GR GR	3 3/8 3 3/8	25 7/16 25 7/16	C C		A A	N	122390
28 1/4	17 1/16	1 1/4	OLDSMOBILE		VT	C	2	14	GR GR	3 1/2 2 3/4	18 5/8 18 5/8	3/8 3/8		A A	N	122461
28 1/4	17 1/16	2	OLDSMOBILE		VT	C	3	12	GR GR	3 7/16 2 3/4	18 5/8 18 5/8	3/8 C		A A	N	122409
34	17 1/16	2	OLDSMOBILE		VT	C	3	13	GR GR	3 1/2 2 3/4	18 5/8 18 5/8	3/8 C		A A	N	124555
34	17 1/16	2	OLDSMOBILE		VT	C	3	15	GR GR	3 1/2 3 1/2	18 5/8 18 5/8	C C		A A	N	124709
OLIVER HART																
15 3/8	16 5/16	2 1/4	OLIVER HART PARR	60	T	C	3	7	GR GR	6 7/8 3	16 5/8 16 5/8	1/4 1/4		A A	N	263032
15 1/2	16 5/16	2 1/4	OLIVER HART PARR		T	C	3	7	GR GR	6 5/8 3	16 3/4 16 3/4	1/8 1/8		A A	N	273032
16 1/4	15 3/16	2 1/4	OLIVER HART PARR	OC4	T	C	3	8	GR GR	3 1/2 2 3/8	15 3/4 15 3/4	1/4 1/4		A A	N	263064

Vista-Pro Automotive - Core Catalog

(Cores Sorted by Application)

Height	Width	Depth	Application	Description	Fin Type	Fin Matl	Rows	FPI	BH/TH Type	BH/TH Width	BH/TH Length	BH/TH OHF	BH/TH Bolts	BH/TH Shape	Hdr Support	Part #
OLIVER HART (Cont)																
16 1/4	16 5/16	2 1/4	OLIVER HART PARR		T	C	3	7	GR GR	6 3/4 3	16 5/8 16 5/8	3/16 3/16		A A	N	270273
16 1/2	15 5/8	2 1/4	OLIVER HART PARR	DC4	X	C	3	7	GR GR	4 3/8 2 1/4	15 5/8 15 5/8	3/16 C		A A	N	265992
16 7/8	15 5/8	2 1/4	OLIVER HART PARR		X	C	3	8	GR GR	6 3/4 3	16 5/8 16 5/8	3/16 3/16		A A	N	288142
16 7/8	16 5/16	2 1/4	OLIVER HART PARR		T	C	3	8	GR GR	6 3/4 3	16 5/8 16 5/8	3/16 3/16		A A	N	223263
17	16 1/4	2 15/16	OLIVER HART PARR	77	Z	C	4	7	GR FR	6 3/4 3 5/8	16 5/8 16 5/8	3/16 3/16		A A	N	281755
17	16 1/4	2 15/16	OLIVER HART PARR	77	Z	C	4	8	SQ SQ	6 3/4 3	16 5/8 16 5/8	3/16 3/16		A A	N	287217
17	16 5/16	3	OLIVER HART PARR		T	C	4	7	GR GR	6 3/4 3 5/8	16 5/8 16 5/8	1/8 1/8		A A	N	279855
17	16 7/8	2 3/16	OLIVER HART PARR		Z	C	3	9	GR GR	6 3/4 3	16 3/4 16 3/4	3/16 3/16		A A	N	280522
17	16 7/8	2 1/4	OLIVER HART PARR	77	T	C	3	8	GR GR	6 3/4 3	16 3/4 16 3/4	FF FF		A A	N	263802
17 1/2	16 1/4	2 3/16	OLIVER HART PARR	70	Z	C	3	8	SQ SQ	6 3/4 3 1/8	16 5/8 16 5/8	11/16 11/16		A A	N	281150
17 1/2	16 1/4	2 1/4	OLIVER HART PARR	70	X	C	3	7	GR GR	6 3/4 3 1/4	16 5/8 16 5/8	3/16 3/16		A A	N	281753
17 1/2	16 5/16	2 1/4	OLIVER HART PARR	70	T	C	3	7	GR GR	6 3/4 3 1/8	16 5/8 16 5/8	1/4 1/4		A A	N	223252
17 1/2	16 5/16	2 1/4	OLIVER HART PARR	55 SUPER	T	C	3	8	GR GR	6 3/4 2 1/2	16 5/8 16 5/8	1/8 1/8		A A	N	271390
19	18 9/16	2 1/4	OLIVER HART PARR		T	C	3	7	GR GR	3 1/4 3 1/4	18 5/8 18 5/8	C C		A A	N	263450
19 5/8	18 1/8	2 1/4	OLIVER HART PARR	COMBINE 88	X	C	3	6	GR GR	6 3/4 3	18 3/4 18 3/4	3/16 3/16		A A	N	280900
19 5/8	18 9/16	2 1/4	OLIVER HART PARR	88 DIESEL	T	C	3	6	GR GR	6 3/4 3	18 3/4 18 3/4	FF FF		A A	N	278459
19 11/16	17 1/2	2 15/16	OLIVER HART PARR	C, 18-27, 18-28	Z	C	4	7	BL BL	6 6	20 1/2 20 1/2	1 1/4 1 1/4	27 27	F F	C	281457
19 11/16	18 9/16	2 1/4	OLIVER HART PARR	88 DIESEL	T	C	3	6	GR GR	6 3/4 3	18 3/4 18 3/4	1/4 1/4		A A	N	261219
19 11/16	18 9/16	3	OLIVER HART PARR	88	T	C	4	6	GR GR	6 3/4 3	18 3/4 18 3/4	1/4 C		A A	N	263062
19 3/4	17 1/2	3	OLIVER HART PARR	80	X	C	4	8	BL BL	6 6	20 5/8 20 5/8	1 3/8 1 3/8	27 27	F F	C	221513
20 3/4	18 9/16	2 1/4	OLIVER HART PARR		T	C	3	9	GR GR	3 1/4 3 1/4	18 3/4 18 3/4	C C		A A	N	279860
20 3/4	18 3/4	2 3/16	OLIVER HART PARR	WHITE	Z	C	3	10	GR GR	3 1/4 3 1/4	18 3/4 18 3/4	C C		A A	N	286613
21 1/4	18 9/16	2 1/4	OLIVER HART PARR	1600	T	C	3	9	GR GR	3 1/2 3 1/2	18 3/4 18 3/4	C C		A A	N	279861
21 1/4	18 3/4	2 3/16	OLIVER HART PARR	1600	Z	C	3	9	SQ SQ	3 1/2 3 1/2	18 3/4 18 3/4	C C		A A	N	286360
21 1/2	18 1/8	3	OLIVER HART PARR	1650-OL	X	C	4	10	SQ SQ	3 3	19 19	C C		A A	N	265983
21 1/2	18 9/16	3	OLIVER HART PARR	CRAWLER	T	C	4	8	GR GR	3 1/4 3 1/4	19 19	C C		A A	N	277207
21 1/2	18 3/4	2 7/8	OLIVER HART PARR	CRAWLER	S	C	5	8	GR GR	3 1/4 3 1/4	19 19	3/16 3/16		A A	N	265982

Vista-Pro Automotive - Core Catalog

(Cores Sorted by Application)

Height	Width	Depth	Application	Description	Fin Type	Fin Matl	Rows	FPI	BH/TH Type	BH/TH Width	BH/TH Length	BH/TH OHF	BH/TH Bolts	BH/TH Shape	Hdr Support	Part #
OLIVER HART (Cont)																
21 1/2	18 3/4	3	OLIVER HART PARR	1600	X	C	4	9	GR	3 1/4	19	3/16		A	N	289178
									GR	3 1/4	19	3/16		A	N	289178
22 1/2	21 7/8	3 11/16	OLIVER HART PARR	OC121956	Z	C	5	8	SQ	6 1/4	22	1/16		A	N	287295
									SQ	4	22	1/16		A	N	287295
23 1/8	20	2 15/16	OLIVER HART PARR		Z	C	4	11	GR	6	22	3/8		A	N	286363
									GR	3 1/2	22	3/8		A	N	286363
23 1/8	20 5/8	2 3/16	OLIVER HART PARR	1800	Z	C	3	9	GR	6	22	1/4		A	N	286362
									GR	3 1/2	22	1/4		A	N	286362
23 1/4	21 3/8	2 1/4	OLIVER HART PARR		T	C	3	11	GR	6	22	1/4		A	N	279433
									GR	3 1/2	22	1/4		A	N	279433
23 1/4	21 3/8	3	OLIVER HART PARR	1800 DIESEL	T	C	4	9	GR	6	22	1/4		A	N	223280
									GR	3 1/2	22	1/4		A	N	223280
23 3/4	20 1/4	3 3/4	OLIVER HART PARR	HI-LIFT	T	C	5	8	BL	6 1/4	24	C	26	J	C	278465
									BL	6 1/4	24	C	26	J	C	278465
23 15/16	21 1/4	2 1/4	OLIVER HART PARR		X	C	3	6	BL	6	24 1/2	1 7/16	27	F	C	260212
									BL	6	24 1/2	1 7/16	27	F	C	260212
27	20 5/8	3	OLIVER HART PARR		X	C	4	9	GR	6	22	1/4		A	C	286364
									GR	3 1/2	22	1/4		A	C	286364
27 1/4	20	3 11/16	OLIVER HART PARR		Z	C	5	11	GR	4 1/4	22	3/8		A	C	282655
									GR	4 1/4	22	3/8		A	C	282655
OMNI - HORIZON																
19 3/4	14 7/8	1 1/4	OMNI-HORIZON		VT	C	2	16	GR	1 5/8	15 3/4	C		A	N	124982
									GR	1 5/8	15 3/4	C		A	N	124982
20 1/2	15 3/8	1 1/4	OMNI-HORIZON		VT	C	2	12	GR	2	16 3/8	C		A	N	124998
									GR	2	16 3/8	C		A	N	124998
20 1/2	15 3/8	1 1/4	OMNI-HORIZON		VT	C	2	16	GR	2	16 3/8	C		A	N	128790
									GR	2	16 3/8	C		A	N	128790
ONAN																
21 1/4	21 3/8	2 1/4	ONAN		T	C	3	8	GR	3 1/2	21 3/4	1/8		A	N	272734
									GR	3 1/2	21 3/4	1/8		A	N	272734
21 1/2	19 13/16	2	ONAN CHIPPER		VT	C	3	12	GR	3	19 5/8	3/16		A	N	122671
									GR	2 1/4	19 5/8	C		A	N	122671
41 5/8	35	2 3/8	ONAN	STATIONARY UNIT WWAUKESHA ENGINE HVY BTM HDR	R	C	4	9	BL	7 3/8	37 1/2	2 3/8	48	A	C	226702
									BH	7 3/8	37 1/2	2 3/8	48	A	C	226702
OPEL																
11 3/4	11	2	OPEL		VT	C	3	12	GR	2 1/2	11 1/2	C		A	N	124528
									GR	2 1/2	11 1/2	C		A	N	124528
12 3/4	14 7/8	2	OPEL		VT	C	3	12	GR	2 1/2	15	C		A	N	124527
									GR	2 1/2	15	C		A	N	124527
13 1/2	19 13/16	1 1/4	OPEL		VT	C	2	12	GR	2	19 13/16	C		A	N	124913
									GR	2	19 13/16	C		A	N	124913
13 7/8	17 5/8	2	OPEL		VT	C	3	12	GR	2 1/2	17 3/4	C		A	N	124863
									GR	2 1/2	17 3/4	C		A	N	124863
ORION BUS																
29	27 1/2	3 7/16	ORION BUS		R	C	6	10	BL	7	30 7/16	C	42	A	C	226886
									BL	7	30 7/16	C	42	A	C	226886
OSHKOSH																
25	35	2 3/8	OSHKOSH TRUCK	X-4330 E-2468-1	R	C	4	11	BL	7	37 1/2	C	46	A	C	226822
									BL	7	37 1/2	C	46	A	C	226822
25	35	3	OSHKOSH TRUCK	X-4003-1 E2468 NEW VH CONSTRUCTION	VH	C	4	14	BL	7	37 1/2	C	46	A	N	251001
									BL	7	37 1/2	C	46	A	N	251001
28 1/2	28 1/8	2 15/16	OSHKOSH TRUCK	HVY T/BTM HDRS BRASS FINS	Z	B	4	11	BH	6 3/8	30	1 1/2	40	A	C	286953
									BH	6 3/8	30	1 1/2	40	A	C	286953

Vista-Pro Automotive - Core Catalog

(Cores Sorted by Application)

Height	Width	Depth	Application	Description	Fin Type	Fin Matl	Rows	FPI	BH/TH Type	BH/TH Width	BH/TH Length	BH/TH OHF	BH/TH Bolts	BH/TH Shape	Hdr Support	Part #
OSHKOSH (Cont)																
28 5/8	35 5/8	3 11/16	OSHKOSH TRUCK		Z	C	5	11	BL BL	7 3/8 7 3/8	38 5/8 38 5/8	C C	46 46	A A	C	282683
31 7/16	40	3 11/16	OSHKOSH TRUCK	ADVANCE MIXER X-3600-3	Z	C	5	9	BL BL	7 3/4 7 3/4	42 1/2 42 1/2	C C	54 54	A A	C	225309
32	26 1/4	4 7/16	OSHKOSH TRUCK	712 BRASS FINIS	Z	B	6	9	BL BL	7 1/4 7 1/4	28 7/8 28 7/8	1 3/8 1 3/8	30 30	EE EE	C	287588
35	39 3/8	2 7/8	OSHKOSH TRUCK	CEMENT MIXER LOW FLOW DIMPLED TUBE	R	C	5	11	BL BL	7 3/4 7 3/4	42 1/2 42 1/2	C C	54 54	A A	C	226038
39 3/4	29 3/8	3 7/16	OSHKOSH TRUCK	X-4839-1 9 3/4 X 4 3/8 CRANK BOX CTRD ON BH	R	C	6	11	BL BL	8 1/4 8 1/4	32 1/8 32 1/8	C C	40 40	A A	C	226896
42	50	5 1/4	OSHKOSH		B	B	7	10	BI BI	9 1/4 9 1/4	53 53	C C	64 64	A A	F	279042
43 1/2	48 1/8	4 7/16	OSHKOSH TRUCK	FIRE TRUCK, HVY T/BTM HDRS BRASS FINIS	Z	B	6	11	BH BH	8 8	50 1/2 50 1/2	C C	70 70	A A	CC	282700
48	48 1/8	3 15/16	OSHKOSH TRUCK	FIRE TRUCK 3552-00506	S	C	7	10	BL BL	8 1/8 8 1/8	50 1/2 50 1/2	1 3/4 1 3/4	66 66	A A	CC	229137
48	47 13/16	4 1/2	OSHKOSH		T	B	6	10	BH BH	8 1/8 8 1/8	50 1/2 50 1/2	1 3/4 1 3/4	66 66	A A	F	269137
OTTAWA TRUCK																
30 5/8	24 3/8	2 7/8	OTTAWA TRUCK	YARD MULE HVY BTM HDR	R	C	5	9	BL BH	6 1/2 6 1/2	27 27	C C	34 34	A A	C	226843
32	26 1/4	3 7/16	OTTAWA TRUCK		R	C	6	11	GR GR	8 1/4 4	26 7/8 26 7/8	3/8 C		A A	C	226704
P&H MANUFACTURING																
29 1/4	29 1/4	4 1/2	P & H MANUFACTURING	HVY BTM HDR	T	C	6	10	BL BH	7 1/4 7 1/4	31 1/4 31 1/4	C C	42 42	A A	C	272935
36	34 7/8	3 3/4	P & H MANUFACTURING	SHOVEL	T	C	5	8	BL BL	8 1/8 8 1/8	37 1/8 37 1/8	2 2	48 48	A A	C	272933
PACER																
23	15 15/16	1 1/4	PACER		VT	C	2	12	GR GR	2 3/4 2 3/4	17 1/2 17 1/2	C C		A A	N	124759
24	15 15/16	2	PACER		VT	C	3	12	GR GR	2 3/4 2 3/4	17 1/2 17 1/2	C C		A A	N	124783
PACKARD																
20 1/2	22 9/16	2	PACKARD		VT	C	3	12	GR GR	3 5/16 2 3/4	23 23	C C		A A	N	128558
25 3/4	20 5/8	2 7/8	PACKARD		S	C	5	10	GR GR	3 3/8 3 3/8	20 1/4 20 1/4	C C		A A	C	265927
PETERBILT																
29	38 3/4	2 7/8	PETERBILT		R	C	5	11	BL BL	9 5/8 7	41 1/8 40 3/8	3 9/16 1 7/16	48 46	F F	C	226257
29	38 3/4	3 7/16	PETERBILT		R	C	6	11	BL BL	9 5/8 7	41 1/8 40 3/8	3 1/2 1 1/2	48 46	F F	C	226256
29 1/4	34 3/8	2 7/8	PETERBILT	LOW FLOW CAN USE 284751 DIMPLED TUBE	R	C	5	11	BL BL	6 5/8 6 5/8	37 1/2 37 1/2	C C	42 42	F F	C	226006
29 1/4	34 1/2	3	PETERBILT	LOW FLOW CAN USE 284751 DIMPLED TUBE	VH	C	4	15	BL BL	6 5/8 6 5/8	37 1/2 37 1/2	C C	42 42	F F	N	251016
30	28 1/8	3 7/16	PETERBILT	348 CONVENTIONAL	R	C	6	11	BL BL	9 5/8 7	30 3/4 30	3 5/16 1 5/16	38 36	DD F	C	226705
30	28 1/8	3 3/4	PETERBILT	348 CONVENTIONAL	X	C	5	11	BL BL	9 5/8 7	30 3/4 30	3 5/16 1 5/16	38 36	DD F	C	286375
30	28 1/8	4 7/16	PETERBILT	CEMENT MIXER BRASS FINIS	Z	B	6	9	BL BL	9 5/8 7	30 3/4 30	3 3/8 C	38 36	H F	C	286996

Vista-Pro Automotive - Core Catalog

(Cores Sorted by Application)

Height	Width	Depth	Application	Description	Fin Type	Fin Matl	Rows	FPI	BH / TH Type	BH / TH Width	BH / TH Length	BH / TH OHF	BH / TH Bolts	BH / TH Shape	Hdr Support	Part #
PETERBILT (Cont)																
32 1/2	22 1/2	2 3/8	PETERBILT		R	C	4	11	SQ SQ	2 7/8 2 7/8	22 3/4 22 3/4	C C		A A	C	224502
33	38 3/4	2 7/8	PETERBILT		R	C	5	11	BL BL	9 5/8 7	41 1/8 40 3/8	3 1/2 1 1/2	48 46	F F	C	226258
36 1/4	34 1/8	1 1/2	PETERBILT	SEE 251118	VTH	C	2	16	BL BL	6 1/2 6 1/2	37 1/2 37 1/2	1 9/16 1 9/16	42 42	F F	N	253118
36 1/4	34 1/8	2 1/4	PETERBILT	SEE 251118	VTH	C	3	14	BL BL	6 1/2 6 1/2	37 1/2 37 1/2	1 9/16 1 9/16	42 42	F F	N	252118
36 1/4	34 1/4	2 1/4	PETERBILT	CAN USE 226149	VH	C	3	14	BL BL	6 1/2 6 1/2	37 1/2 37 1/2	C C	42 42	F F	N	251118
36 1/4	34 3/8	1 1/2	PETERBILT	ULTRAFUSED HDRS	VH	C	2	13	BL BL	6 1/2 6 1/2	37 1/2 37 1/2	C C	42 42	0 A	N	280551
36 1/4	34 3/8	2 3/8	PETERBILT	359	R	C	4	11	BL BL	6 1/2 6 1/2	37 1/2 37 1/2	1 3/4 1 3/4	42 42	0 A	C	220038
36 1/4	34 3/8	2 3/8	PETERBILT	359 COE LOW FLOW DIMPLED TUBE	R	C	4	11	BL BL	6 1/2 6 1/2	37 1/2 37 1/2	C C	42 42	F F	C	226041
36 1/4	34 3/8	2 3/8	PETERBILT	359 CONVENTIONAL	R	C	4	11	BL BL	6 1/2 6 1/2	37 1/2 37 1/2	C C	42 42	A A	C	226149
36 1/4	34 3/8	2 7/8	PETERBILT	359 COE CAN USE 284030	R	C	5	11	BL BL	6 5/8 6 5/8	37 1/2 37 1/2	C C	42 42	F F	C	226846
36 1/4	34 3/8	2 7/8	PETERBILT	359 COE LOW FLOW DIMPLED TUBE	R	C	5	11	BL BL	6 1/2 6 1/2	37 17/32 37 17/32	C C	42 42	F F	C	226030
36 1/4	34 1/2	2 1/4	PETERBILT	359 COE LOW FLOW CAN USE 284065 DIMPLED TUBE	VH	C	3	15	BL BL	6 1/2 6 1/2	37 1/2 37 1/2	C C	42 42	F F	N	251041
36 1/4	34 1/2	3	PETERBILT	359 COE CAN USE 226846	VH	C	4	14	BL BL	6 1/2 6 1/2	37 1/2 37 1/2	C C	42 42	F F	N	251123
36 1/4	34 1/2	3	PETERBILT	359 COE LOW FLOW DIMPLED TUBE	VH	C	4	15	BL BL	6 1/2 6 1/2	37 1/2 37 1/2	C C	42 42	F F	N	251033
36 1/4	34 1/2	1 1/2	PETERBILT	SEE 251041 DIMPLED TUBE	VTH	C	2	16	BL BL	6 1/2 6 1/2	37 1/2 37 1/2	C C	42 42	F F	N	253041
36 1/4	34 1/2	2 1/4	PETERBILT	SEE 251041 DIMPLED TUBE	VTH	C	3	15	BL BL	6 1/2 6 1/2	37 1/2 37 1/2	C C	42 42	F F	N	252041
36 1/4	34 1/2	2 1/4	PETERBILT	SEE 251123	VTH	C	3	16	BL BL	6 1/2 6 1/2	37 1/2 37 1/2	C C	42 42	F F	N	253123
36 1/4	34 1/2	2 1/4	PETERBILT	SEE 251033 DIMPLED TUBE	VTH	C	3	15	BL BL	6 1/2 6 1/2	37 1/2 37 1/2	C C	42 42	F F	N	252041
36 1/4	34 1/2	3	PETERBILT	SEE 251123	VTH	C	4	14	BL BL	6 1/2 6 1/2	37 1/2 37 1/2	C C	42 42	F F	N	252123
36 1/4	34 1/2	3	PETERBILT	SEE 251033 DIMPLED TUBE	VTH	C	4	15	BL BL	6 1/2 6 1/2	37 1/2 37 1/2	C C	42 42	F F	N	252033
36 1/4	34 3/4	2 1/4	PETERBILT	362 ULTRA-FUSED LOW FLOW CAN USE 251041 DIMPLED TUBE	VH	C	3	13	BL BL	6 1/2 6 1/2	37 1/2 37 1/2	C C	42 42	F F	N	284065
36 1/4	34 3/4	2 1/4	PETERBILT	ULTRA-FUSED CAN USE 226149	VH	C	3	13	BL BL	6 1/2 6 1/2	37 1/2 37 1/2	C C	42 42	F F	N	284708
36 1/4	34 3/4	3	PETERBILT	359 COE ULTRA-FUSED CAN USE 226846	VH	C	4	13	BL BL	6 5/8 6 5/8	37 1/2 37 1/2	C C	42 42	F F	N	284030
36 1/4	34 3/4	3	PETERBILT	359 CONVENTIONAL ULTRA-FUSED LOW FLOW CAN USE 251033 DIMPLED TUBE	VH	C	4	13	BL BL	6 5/8 6 5/8	37 1/2 37 1/2	C C	42 42	F F	N	284646
36 1/4	34 1/4	2 1/4	PETERBILT		VH	C	3	14	BL BL	6 1/2 6 1/2	37 1/2 37 1/2	1 5/8 1 5/8	42 42	F F	C	251218
36 1/4	34 3/8	2 7/8	PETERBILT		R	C	5	11	BL BL	6 1/2 6 1/2	37 1/2 37 1/2	1 1/2 1 1/2	42 42	F F	C	266846

Vista-Pro Automotive - Core Catalog

(Cores Sorted by Application)

Height	Width	Depth	Application	Description	Fin Type	Fin Matl	Rows	FPI	BH/TH Type	BH/TH Width	BH/TH Length	BH/TH OHF	BH/TH Bolts	BH/TH Shape	Hdr Support	Part #
PETERBILT (Cont)																
36 1/4	34 9/16	2 1/4	PETERBILT		VTH	C	3	14	BL BL	6 1/2 6 1/2	37 1/2 37 1/2	1 3/4 1 3/4	42 42	A A	C	252119
36 1/4	34 3/8	2 3/8	PETERBILT		R	C	4	11	BL BL	6 1/2 6 1/2	37 1/2 37 1/2	1 9/16 1 9/16	42 42	A A	C	289990
36 1/2	29 1/2	3	PETERBILT	WITH PTO; LOW FLOW DIMPLED TUBE	B	C	4	9	BL BH	6 6	31 1/4 31 1/4	C C	42 42	A A	C	220003
37 1/2	28 1/8	2 7/8	PETERBILT	352 COE	R	C	5	11	BL BL	9 5/8 7	30 3/4 30	3 1/2 1 1/2	38 36	F F	C	226261
37 1/2	28 1/8	3 7/16	PETERBILT	352 COE HVY BTM HDR	R	C	6	11	BL BH	9 5/8 7	30 3/4 30	3 5/16 1 5/16	38 36	DD F	C	226706
37 1/2	28 1/8	4 7/16	PETERBILT	351, 352	R	C	8	8	BL BH	9 5/8 7	30 3/4 30	3 5/16 C	38 36	A A	C	226707
37 1/2	28 1/8	4 1/2	PETERBILT	351 HALL SCOTT HVY BTM HDR	T	C	6	9	BL BH	9 5/8 7	30 3/4 30	1 7/8 C	38 36	A A	C	271398
37 1/2	28 1/8	5 3/16	PETERBILT	BRASS FINS	Z	B	7	11	BL SQ	12 7/8 8 1/2	30 3/4 30	3 5/8 C	42 38	H A	C	286664
37 1/2	28 1/8	5 1/4	PETERBILT	HVY BTM HDR	T	C	7	8	BL BH	12 7/8 8 1/2	30 3/4 30	3 1/2 C	42 38	H A	C	277419
37 1/2	28 1/2	3	PETERBILT	ULTRA-FUSED LOW FLOW CAN USE 226019 DIMPLED TUBE	VH	C	4	16	BL BL	9 5/8 7	30 3/4 30	C 1 5/16	38 36	F F	N	284696
37 1/2	38	3	PETERBILT	LOW FLOW DIMPLED TUBE	VH	C	4	15	BL BL	9 5/8 7	41 1/8 40 3/8	3 15/16 1 7/8	48 46	B B	N	251020
37 1/2	38 1/8	2 7/8	PETERBILT	LOW FLOW DIMPLED TUBE	R	C	5	11	BL BL	9 5/8 7	41 1/8 40 3/8	3 15/16 1 7/8	48 46	B B	C	226011
37 1/2	38 1/8	4 7/16	PETERBILT	359 HVY BTM HDR	R	C	8	10	BL BH	9 5/8 7	41 1/8 40 3/8	3 1/8 C	48 46	F F	C	226709
37 1/2	38 1/8	4 7/16	PETERBILT	359 CONVENTIONAL BRASS FINS	Z	B	6	11	BL BL	9 5/8 7	41 1/8 40 3/8	3 5/16 1 5/16	48 46	F F	C	289830
37 1/2	38 1/4	3	PETERBILT	359	T	C	4	8	BL BL	9 5/8 7	41 1/8 40 3/8	C 1 3/8	48 46	F F	C	265003
37 1/2	38 1/4	4 1/2	PETERBILT	HVY BTM HDR	T	C	6	8	BL BH	9 5/8 7	41 1/8 40 3/8	3 1/4 C	48 46	F F	C	223021
37 1/2	38 5/16	2 1/4	PETERBILT	SEE 251125	VTH	C	3	16	BL BL	9 5/8 7	41 1/8 40 3/8	3 1/2 1 1/2	48 46	B B	N	253125
37 1/2	38 5/16	3	PETERBILT	SEE 251125	VTH	C	4	14	BL BL	9 5/8 7	41 1/8 40 3/8	3 1/2 1 1/2	48 46	B B	N	252125
37 1/2	38 1/2	3	PETERBILT	359 CONVENTIONAL CAN USE 226255	VH	C	4	14	BL BL	9 5/8 7	41 1/8 40 3/8	3 1/2 1 1/2	48 46	B B	N	251125
37 1/2	38 3/4	2 3/8	PETERBILT	359 CONVENTIONAL HVY BTM HDR	R	C	4	11	BL BH	9 5/8 7	41 1/8 40 3/8	3 15/16 1 15/16	48 46	F F	C	226254
37 1/2	38 3/4	2 7/8	PETERBILT	359 CONVENTIONAL	R	C	5	11	BL BL	9 5/8 7	41 1/8 40 3/8	3 1/2 1 1/2	48 46	B B	C	226255
37 1/2	38 3/4	3 7/16	PETERBILT	359 0703772	R	C	6	11	BL BL	9 5/8 7	41 1/8 40 3/8	3 5/16 1 5/16	48 46	F F	C	226710
37 1/2	38 3/4	3 3/4	PETERBILT	359 CONVENTIONAL	X	C	5	8	BL BL	9 5/8 7	41 1/8 40 3/8	2 3/4 2 1/8	48 46	F F	C	286450
37 1/2	38 3/4	3	PETERBILT	359 CONVENTIONAL ULTRA- FUSED CAN USE 226255	VH	C	4	14	BL BL	9 5/8 7	41 1/8 40 3/8	3 1/2 1 1/2	48 46	F F	N	284090
39 1/4	29 1/2	3	PETERBILT	LOW FLOW, WITH PTO BOX DIMPLED TUBE	B	C	4	9	BL BH	6 6	31 1/4 31 1/4	C C	42 42	A A	C	220001
41	29 1/2	3	PETERBILT		VTH	C	4	14	BL BH	6 6	31 1/4 31 1/4	C C	42 42	0 0	N	252117
42	34 7/8	3 3/4	PETERBILT	HVY T/BTM HDRS	T	C	5	7	BH BH	8 8	37 1/2 37 1/2	C C	44 44	A A	C	266594

Vista-Pro Automotive - Core Catalog

(Cores Sorted by Application)

Height	Width	Depth	Application	Description	Fln Type	Fln Matl	Rows	FPI	BH/TH Type	BH/TH Width	BH/TH Length	BH/TH OHF	BH/TH Bolts	BH/TH Shape	Hdr Support	Part #
PETERBILT (Cont)																
42	35	3	PETERBILT	362 07-04788	X	C	4	8	BL	8	37 1/2	C	44	F	C	281889
									BL	8	37 1/2	C	44	F		
42	35	3 7/16	PETERBILT	362	R	C	6	11	BL	8	37 1/2	1 3/4	44	F	C	226253
									BL	8	37 1/2	1 3/4	44	F		
PETTIBONE																
16 3/4	26 1/4	5 3/16	PETTIBONE	CRANE HERCULES ENGINE BRASS FINS	Z	B	7	9	GR	5 1/2	27	C		A	N	289173
									GR	5 1/2	27	C		A		
16 3/4	26 7/16	5 1/4	PETTIBONE	HERCULES ENGINE	T	C	7	9	GR	5 1/2	27	C		A	N	223248
									GR	5 1/2	27	C		A		
22 5/8	25	2 3/16	PETTIBONE	INTERNATIONAL ENGINE	Z	C	3	6	GR	5 1/4	25 9/16	1 1/4		A	N	282586
									GR	4	25 9/16	1 1/4		A		
25	23 5/8	3	PETTIBONE	402 GRADER	T	C	4	8	BL	6 1/8	26 7/8	1 1/4	32	A	C	263483
									BL	6 1/8	26 7/8	1 1/4	32	A		
30	27 1/2	4 7/16	PETTIBONE	BRASS FINS	Z	B	6	8	GR	5	28 3/4	C		A	C	286955
									GR	5	28 3/4	C		A		
PEUGEOT																
19 1/4	15 15/16	1 1/4	PEUGEOT		VT	C	2	12	GR	1 7/8	15 5/8	C		A	N	128115
									GR	1 7/8	15 5/8	C		A		
PIERCE FIRE TRUCK																
43 3/8	28 1/8	3 7/16	PIERCE FIRE TRUCK	FIRE TRUCK	R	C	6	11	BL	7	30 3/8	C	42	A	C	226287
									BL	7	30 3/8	C	42	A		
PINTO																
15 1/4	17 1/16	1 1/4	PINTO		VT	C	2	13	BU	3 1/8	17 3/8	C		A	N	124567
									GR	1 5/8	16 3/4	C		A		
16 3/8	20 3/8	1 1/4	PINTO		VT	C	2	12	BU	3 3/16	20 7/16	C		A	N	124832
									GR	1 5/8	19 13/16	C		A		
PLYMOUTH																
12 3/4	16 1/2	1 1/4	PLYMOUTH		VT	C	2	12	GR	1 13/16	16 7/8	C		A	N	124946
									GR	1 13/16	16 7/8	C		A		
17 3/8	18 11/16	1 1/4	PLYMOUTH		VT	C	2	12	GR	2 7/8	18 1/4	1/8		A	N	124507
									GR	1 3/4	18 1/2	C		A		
17 1/2	25 7/8	1 1/4	PLYMOUTH		VT	C	2	12	GR	3	25 9/16	3/8		A	N	122522
									GR	2 3/4	25 9/16	3/8		A		
18	18 11/16	1 1/4	PLYMOUTH		VT	C	2	16	GR	2 7/8	18 1/4	FR		A	N	128781
									GR	1 3/4	18 1/2	C		A		
18	25 7/8	1 1/4	PLYMOUTH		VT	C	2	12	GR	2	25 9/16	C		A	N	124823
									GR	2	25 9/16	C		A		
18 1/8	22	1 1/4	PLYMOUTH		VT	C	2	12	BU	4	22 1/4	FF		A	N	122344
									GR	2	21 3/4	C		A		
19	18 11/16	1 1/4	PLYMOUTH		VT	C	2	13	GR	2 7/8	18 1/4	FF		A	N	124737
									GR	1 3/4	18 1/2	FF		A		
PONTIAC																
23	17 1/16	2 5/8	PONTIAC		VT	C	4	12	GR	3 1/2	18 5/8	C		A	N	122558
									GR	3 1/2	18 5/8	C		A		
26 3/8	17 1/16	2	PONTIAC		VT	C	3	12	GR	3 1/2	18 5/8	3/8		A	N	122443
									GR	2 3/4	18 5/8	3/8		A		
26 3/8	17 1/16	2 5/8	PONTIAC		VT	C	4	12	GR	3 1/2	18 5/8	C		A	N	122445
									GR	3 1/2	18 5/8	C		A		
PORSCHE																
20 1/16	12 3/8	1 9/16	PORSCHE		VE	C	3	16	GR	1 3/4	12 3/8	C		A	N	122685
									GR	1 3/4	12 3/8	C		A		
QUINCY COMPRESSOR																
39 5/16	38 13/16	2 1/4	QUINCY COMPRESSOR	HVY T/BTM HDRS	T	C	3	9	BH	6	41	C	48	A	C	272737
									BH	6	41	C	48	A		

Vista-Pro Automotive - Core Catalog

(Cores Sorted by Application)

Height	Width	Depth	Application	Description	Fin Type	Fin Matl	Rows	FPI	BH/TH Type	BH/TH Width	BH/TH Length	BH/TH OHF	BH/TH Bolts	BH/TH Shape	Hdr Support	Part #
RAMBLER																
14 5/8	24 3/16	1 1/4	RAMBLER		VT	C	2	12	GR	2 13/16	24 5/8	5/8		A	N	122447
									GR	1 3/4	24 5/8	C		A		
14 5/8	24 3/16	1 1/4	RAMBLER		VT	C	2	12	GR	2 13/16	24 5/8	FR		A	N	122531
									GR	1 3/4	24	C		A		
15 1/8	18 11/16	1 1/4	RAMBLER		VT	C	2	14	GR	2 7/8	18 1/4	FF		A	N	124571
									GR	1 3/4	18 1/2	FF		A		
15 3/4	24 3/16	1 1/4	RAMBLER		VT	C	2	12	GR	2 3/4	24 5/8	5/8		A	N	122577
									GR	1 3/4	24	C		A		
15 3/4	24 3/16	2	RAMBLER		VT	C	3	12	GR	2 13/16	24 5/8	C		A	N	124520
									GR	2 1/4	24	C		A		
16 7/8	24 3/16	1 1/4	RAMBLER		VT	C	2	12	GR	2 13/16	24 5/8	3/16		A	N	122317
									GR	1 3/4	24 5/8	C		A		
16 7/8	24 3/16	1 1/4	RAMBLER		VT	C	2	14	GR	2 13/16	24 5/8	5/16		A	N	122485
									GR	2 1/4	24	C		A		
16 7/8	24 3/16	1 1/4	RAMBLER		VT	C	2	12	GR	2 13/16	24 5/8	5/8		A	N	122532
									GR	1 3/4	24	C		A		
16 7/8	24 3/16	1 1/4	RAMBLER		VT	C	2	16	GR	2 1/4	24	FF		A	N	124784
									GR	1 3/4	24	FF		A		
16 7/8	24 3/16	2	RAMBLER		VT	C	3	12	GR	2 13/16	24 5/8	3/16		A	N	122481
									GR	2 1/4	24 5/8	C		A		
16 7/8	24 3/16	2	RAMBLER		VT	C	3	12	GR	2 13/16	24 5/8	3/16		A	N	122547
									GR	2 1/4	24	C		A		
24	15 15/16	1 1/4	RAMBLER		VT	C	2	16	GR	2 3/4	17 1/2	C		A	N	124782
									GR	2 3/4	17 1/2	C		A		
REX																
19 1/4	18 9/16	3 3/4	REX	PAVER	T	C	5	9	GR	4 1/8	19 7/8	C		A	N	279898
									GR	4 1/8	19 7/8	C		A		
28	39 1/2	4 1/2	REX	COMPACTOR HVY T/BTM HDRS	B	C	6	7	BH	7 3/4	42	C	60	A	C	272938
									BH	7 3/4	42	C	60	A		
ROLLS ROYCE																
16 1/8	25 7/8	2 5/8	ROLLS ROYCE		VT	C	4	14	GR	3 1/8	26	C		A	N	128387
									GR	3 1/8	26	C		A		
ROVER																
17 3/8	18 9/16	3	ROVER		T	C	4	11	GR	4 1/8	18 7/8	C		A	N	264337
									GR	3 1/4	18 7/8	C		A		
SAAB																
20 3/8	12 5/8	1 1/4	SAAB		VT	C	2	16	GR	1 3/4	13 5/16	C		A	N	128205
									GR	1 3/4	13 5/16	C		A		
20 5/8	12 13/16	1 9/16	SAAB		VE	C	3	14	GR	2 3/8	13 3/8	C		A	N	122699
									GR	2 3/8	13 3/8	C		A		
20 5/8	13 3/16	1 1/4	SAAB		VT	C	2	12	GR	2 3/8	13 3/8	C		A	N	128104
									GR	2 3/8	13 3/8	C		A		
20 5/8	13 3/16	2	SAAB		VT	C	3	14	GR	2 3/8	13 3/8	C		A	N	124619
									GR	2 3/8	13 3/8	C		A		
23 1/2	12 13/16	1 9/16	SAAB		VE	C	3	16	GR	1 3/4	13 5/16	C		A	N	122689
									GR	1 3/4	13 5/16	C		A		
SCHRAMM																
24	24 3/4	3	SCHRAMM		T	C	4	9	BL	5 1/2	27	C	36	A	C	265533
									BL	5 1/2	27	C	36	A		
48 1/4	63 9/16	3 3/4	SCHRAMM	ROTARY DRILL HVY T/BTM HDRS	T	C	5	11	BH	6 3/4	66 1/2	C	72	A	CC	272942
									BH	6 3/4	66 1/2	C	72	A		

Vista-Pro Automotive - Core Catalog

(Cores Sorted by Application)

Height	Width	Depth	Application	Description	Fin Type	Fin Matl	Rows	FPI	BH / TH Type	BH / TH Width	BH / TH Length	BH / TH OHF	BH / TH Bolts	BH / TH Shape	Hdr Support	Part #
SEAGRAVE																
32	30	4 7/16	SEAGRAVE	FIRE ENGINE HVY BTM HDR BRASS FINS	Z	B	6	11	BL BH	7 15/16 7 15/16	32 3/4 32 3/4	C C	44 44	A A	C	282757
34	45	4 7/16	SEAGRAVE	HVY BTM HDR BRASS FINS	Z	B	6	11	BL BH	7 5/8 7 5/8	48 48	C C	58 58	A A	CC	281931
SPEED SPRAYER																
20 1/4	19 1/8	3	SPEED SPRAYER	SPEEDSPRAYER	T	C	4	8	GR GR	4 1/4 4 1/4	20 20	1/4 1/4		A A	N	265367
23	23 1/16	4 1/2	SPEED SPRAYER	SOLDER COATED FINS	T	SC	6	9	GR GR	5 3/8 4 7/8	23 1/4 23 1/4	C C		A A	N	273459
23 3/4	23 1/8	3	SPEED SPRAYER		X	C	4	9	SQ SQ	4 4	23 1/4 23 1/4	1/4 1/4		A A	N	286785
24 1/2	24 3/4	3 3/4	SPEED SPRAYER		T	C	5	8	GR GR	4 5/8 4 5/8	25 1/2 25 1/2	1/4 1/4		A A	C	265368
STEIGER TRACTOR																
22 3/4	24 3/4	4 1/2	STEIGER TRACTOR	BEARCAT II	T	C	6	9		4 3/4 4 3/4	25 1/2 25 1/2	C C		0 0	N	265535
28 7/8	28 3/4	5 3/16	STEIGER TRACTOR	PANTHER BRASS FINS	Z	B	7	11	GR GR	5 5/8 5 5/8	29 3/4 29 3/4	C C		A A	C	286649
28 7/8	29 1/4	5 1/4	STEIGER TRACTOR	PANTHER	T	C	7	9	GR GR	5 5/8 5 5/8	29 3/4 29 3/4	C C		A A	C	265536
37 7/8	34 5/16	4 1/2	STEIGER TRACTOR	4 WD TRACTOR HVY BTM HDR	T	C	6	9	BL BH	7 7/8 7 7/8	36 36	C C	48 48	A A	CC	272945
38	33 3/4	4 1/2	STEIGER TRACTOR	HVY T/BTM HDRS	T	C	6	8	BH BH	7 7/8 7 7/8	36 36	C C	48 48	A A	C	265870
STUDEBAKER																
14 7/8	24 3/16	2	STUDEBAKER		VT	C	3	12	GR GR	2 13/16 2 13/16	24 5/8 24 5/8	C C		A A	N	122209
17 1/2	25 5/16	2 1/4	STUDEBAKER		T	C	3	8	CR CR	5 1/2 3 3/4	25 1/2 25 1/2	1/2 1/2		A A	N	260281
17 3/4	24 3/16	1 1/4	STUDEBAKER		VT	C	2	12	GR GR	2 13/16 2 13/16	24 5/8 24 5/8	C C		A A	N	122221
17 3/4	24 3/16	1 1/4	STUDEBAKER		VT	C	2	12	BU GR	3 1/2 2 1/4	24 3/4 24 7/8	1/4 C		A A	N	122280
17 3/4	24 3/16	1 1/4	STUDEBAKER		VT	C	2	12	BU GR	3 1/2 2 1/4	24 3/4 24 7/8	C C		A A	N	122478
17 3/4	24 3/16	2	STUDEBAKER		VT	C	3	12	GR GR	2 13/16 2 13/16	24 5/8 24 5/8	C C		A A	N	122253
17 3/4	24 3/16	2	STUDEBAKER		VT	C	3	12	BU GR	3 1/2 2 1/4	24 3/4 24 7/8	1/4 C		A A	N	122282
17 3/4	24 3/16	2	STUDEBAKER		VT	C	3	12	BU GR	3 1/2 2 1/4	24 3/4 24 5/8	C C		A A	N	122395
20 1/4	25 5/16	3	STUDEBAKER TRUCK		T	C	4	8	GR GR	3 7/8 3 3/8	25 1/2 25 1/2	1/4 1/4		0 0	N	261181
22 3/8	19 1/4	2	STUDEBAKER		VT	C	3	12	GR GR	2 1/2 2 1/2	19 1/16 19 1/16	C C		A A	N	122452
SUBARU																
23	13 3/16	1 1/4	SUBARU		VT	C	2	14	GR GR	2 7/8 1 7/8	13 1/2 13 1/2	FF C		A A	N	124993
SULLAIR																
21	23 3/4	2 3/16	SULLAIR	COMPRESSOR	Z	C	3	10	GR GR	4 4	24 24	3/16 3/16		A A	N	281854
21 9/16	23 1/16	2 1/4	SULLAIR		T	C	3	9	GR GR	3 3	24 24	C C		A A	N	223278

Vista-Pro Automotive - Core Catalog

(Cores Sorted by Application)

Height	Width	Depth	Application	Description	Fin Type	Fin Matl	Rows	FPI	BH/TH Type	BH/TH Width	BH/TH Length	BH/TH OHF	BH/TH Bolts	BH/TH Shape	Hdr Support	Part #
SULLAIR (Cont)																
21 5/8	23 1/8	2 3/16	SULLAIR		Z	C	3	10	GR GR	3 3	24 24	3/16 3/16		A A	N	289161
44	46 1/8	2 1/4	SULLAIR	DETROIT ENGINE	T	C	3	8	BL BL	5 7/8 5 7/8	48 5/8 48 5/8	C C	56 56	A A	CC	279933
SUNBEAM																
10 3/4	20 7/8	2	SUNBEAM		VT	C	3	12	GR GR	2 1/4 2 1/4	21 3/8 21 3/8	C C		A A	N	124623
18 5/8	15 3/8	2	SUNBEAM		VT	C	3	12	GR GR	2 3/16 2 3/16	15 3/4 15 3/4	C C		A A	N	128366
SUZUKI																
13 3/4	15 3/8	1 1/4	SUZUKI		VT	C	2	12	GR GR	1 7/8 1 7/8	15 5/8 15 5/8	C C		A A	N	128737
TEMPEST																
15 1/2	25 5/16	2	TEMPEST		VT	C	3	12	GR GR	2 3/4 2 3/4	25 7/16 25 7/16	C C		A A	N	122347
TEREX																
28	28 3/4	3 11/16	TEREX	TS-14B HVY BTM HDR	Z	C	5	9	BL BH	7 1/2 7 1/2	32 32	1 3/8 1 3/8	42 42	A A	C	225410
30 1/4	29 3/8	3 3/4	TEREX	LIFT	X	C	5	8	GR GR	4 7/8 4 7/8	29 3/4 29 3/4	3/8 3/8		A A	C	289563
34	31 1/4	4 7/16	TEREX	HVY T/BTM HDRS BRASS FINS	Z	B	6	8	BH BH	8 3/8 8 3/8	35 5/8 35 5/8	C C	46 46	B B	C	281976
36 1/2	28 3/4	3 11/16	TEREX	72-51 LOADER	Z	C	5	8	GR GR	4 7/8 4 7/8	29 3/4 29 3/4	C C		A A	C	286798
38 1/4	34 7/8	4 1/2	TEREX	TS-18 SCRAPER HVY BTM HDR	T	C	6	7	BL BH	8 1/2 8 1/2	40 40	C C	50 50	A A	C	265593
42	49 3/8	4 7/16	TEREX	82-50 DOZER HVY T/BTM HDRS BRASS FINS	Z	B	6	9	BH BH	8 3/8 8 3/8	53 53	C C	64 64	A A	CC	281962
43 1/2	43 3/4	6	TEREX	9059581 HVY T/BTM HDRS BRASS FINS	Z	B	8	8	BH BH	10 1/2 10 1/2	49 49	C C	62 62	A A	CC	225485
TERRA GATOR																
34 5/8	23	3 3/4	TERRA-GATOR/TERRA-TR	CAT ENGINE HVY T/BTM HDRS	B	C	5	7	BH BH	6 1/4 6 1/4	25 1/4 25 1/4	C C	34 34	A A	C	272946
THOMAS BUS																
31 7/8	28 3/4	1 3/4	THOMAS BUS		R	C	3	11	BL BL	6 7/8 6 7/8	31 1/4 31 1/4	2 2	40 40	A A	C	226598
TIMBER JACK																
14	24 3/8	2 15/16	TIMBER JACK		Z	C	4	10	GR GR	3 1/2 3 1/2	25 3/4 25 3/4	C C		A A	N	286631
15 1/2	25	3 3/4	TIMBER JACK		X	C	5	9	SQ SQ	4 3/4 4 3/4	26 26	C C		A A	N	286874
22	26 1/4	6	TIMBER JACK	240A SKIDDER BRASS FINS BAFFLED	Z	B	8	6	GR GR	6 3/8 6 3/8	26 7/8 26 7/8	C C		A A	N	282970
33	26	6	TIMBER JACK	HVY T/BTM HDRS BRASS FINS FACE DIPPED	B	B	8	6	BH BH	9 9	29 3/4 29 3/4	C C	40 40	A A	C	272947
TORO																
14 3/4	16 1/4	3	TORO	LAWN MOWER	X	C	4	8	GR GR	3 1/4 3 1/4	16 1/2 16 1/2	C C		A A	N	286416
TORONADO																
34	17 1/16	2	TORONADO		VT	C	3	15	GR GR	2 3/4 2 3/4	18 5/8 18 5/8	C C		A A	N	124726

Vista-Pro Automotive - Core Catalog

(Cores Sorted by Application)

Height	Width	Depth	Application	Description	Fin Type	Fin Matl	Rows	FPI	BH/TH Type	BH/TH Width	BH/TH Length	BH/TH OHF	BH/TH Bolts	BH/TH Shape	Hdr Support	Part #
TOYOTA																
12 3/4	16 1/2	2	TOYOTA		VT	C	3	12	GR GR	2 1/4 2 1/4	16 3/4 16 3/4	C C		A A	N	128165
12 3/4	19 1/4	1 1/4	TOYOTA		VT	C	2	12	BU GR	2 13/16 1 7/8	19 7/16 19 5/8	C C		A A	N	124625
12 3/4	19 1/4	1 1/4	TOYOTA		VT	C	2	12	GR GR	1 7/8 1 7/8	19 5/8 19 5/8	C C		A A	N	124725
14 3/4	17 5/8	1 1/4	TOYOTA		VT	C	2	12	GR GR	2 7/8 1 7/8	17 5/8 17 11/16	C C		A A	N	124606
14 3/4	18 1/8	1 1/4	TOYOTA		VT	C	2	12	GR GR	2 1/2 1 3/4	18 18 1/4	3/16 7/16		A A	N	122305
14 3/4	19 1/4	2	TOYOTA		VT	C	3	12	GR GR	2 1/2 2 1/2	19 1/2 19 1/2	C C		A A	N	124729
14 3/4	20 5/8	1 9/16	TOYOTA		VE	C	3	14	GR GR	1 7/8 1 7/8	21 21	C C		A A	N	128101
14 3/4	20 7/8	1 1/4	TOYOTA		VT	C	2	14	GR GR	1 3/4 1 3/4	20 7/8 20 7/8	C C		A A	N	124773
14 3/4	20 7/8	1 1/4	TOYOTA		VT	C	2	12	GR GR	2 2	21 21	C C		A A	N	128785
14 3/4	20 7/8	2	TOYOTA		VT	C	3	12	GR GR	2 1/2 2 1/2	21 21	C C		A A	N	124774
14 3/4	25 5/16	1 1/4	TOYOTA		VT	C	2	13	GR GR	1 7/8 1 7/8	25 3/4 25 3/4	C C		A A	N	128125
15 1/4	17 5/8	1 1/4	TOYOTA		VT	C	2	12		3 5/16 1 7/8	17 3/4 17 11/16	5/16 C		0 0	N	124522
15 5/8	22	2	TOYOTA		VT	C	3	12	GR GR	2 3/4 2 3/4	22 1/16 22 1/16	1/8 1/8		A A	N	128645
15 3/4	19 1/4	1 1/4	TOYOTA		VT	C	2	14	GR GR	1 3/4 1 3/4	19 1/2 19 1/2	C C		A A	N	124713
15 3/4	19 1/4	2	TOYOTA		VT	C	3	12	GR GR	2 1/2 2 1/2	19 1/2 19 1/2	C C		A A	N	124714
15 3/4	20 7/8	2	TOYOTA		VT	C	3	12	GR GR	2 1/2 2 1/2	21 21	C C		A A	N	124775
15 3/4	21 1/16	1	TOYOTA		VE	C	2	16	GR GR	1 7/8 1 7/8	21 21	C C		A A	N	128276
15 3/4	22	2 5/8	TOYOTA		VT	C	4	12	GR GR	2 3/4 2 3/4	22 22	C C		0 A	N	124607
15 3/4	24 3/16	2 5/8	TOYOTA		VT	C	4	12	GR GR	3 3	24 1/4 24 1/4	C C		A A	N	128688
15 3/4	25 5/16	1 1/4	TOYOTA		VT	C	2	14	GR GR	1 7/8 1 7/8	25 3/4 25 3/4	C C		A A	N	124980
16 3/4	20 5/8	1 9/16	TOYOTA		VE	C	3	16	GR GR	2 1/2 2 1/2	21 21	C C		A A	N	128787
16 3/4	20 7/8	1 1/4	TOYOTA		VT	C	2	12	GR GR	1 7/8 1 7/8	21 21	C C		A A	N	128708
16 3/4	21 1/16	1 9/16	TOYOTA		VE	C	3	16	GR GR	1 7/8 1 7/8	21 21	C C		A A	N	128797
17	19 1/4	2	TOYOTA		VT	C	3	12	GR GR	2 7/8 2 7/8	19 3/4 19 3/4	C C		A A	N	124809
17	19 13/16	2 5/8	TOYOTA		VT	C	4	12	GR FR	2 7/8 2 3/4	19 5/8 19 5/8	C C		A A	N	128608
17 1/8	19 13/16	2 5/8	TOYOTA		VT	C	4	12	GR FR	3 2 3/4	19 13/16 19 13/16	C C		A A	N	128439
17 1/4	19 1/4	2	TOYOTA		VT	C	3	12	GR GR	3 3	19 7/8 19 7/8	C C		A A	N	122279

Vista-Pro Automotive - Core Catalog

(Cores Sorted by Application)

Height	Width	Depth	Application	Description	Fin Type	Fin Matl	Rows	FPI	BH/TH Type	BH/TH Width	BH/TH Length	BH/TH OHF	BH/TH Bolts	BH/TH Shape	Hdr Support	Part #
TOYOTA (Cont)																
18 5/8	20 7/8	2	TOYOTA		VT	C	3	13	GR GR	2 1/2 2 1/2	21 21	C C		A A	N	128839
TREE FARMER																
14	25	4 7/16	TREE FARMER	BRASS FINS	Z	B	6	9	GR GR	4 3/4 4 3/4	25 3/4 25 3/4	C C		A A	N	289210
14	25	4 1/2	TREE FARMER		B	C	6	7	GR GR	4 3/4 4 3/4	25 3/4 25 3/4	C C		A A	N	279947
20 1/2	19 3/8	3	TREE FARMER	CHIPPER	X	C	4	9	GR GR	4 4	20 20	3/16 3/16		A A	N	289885
TRIUMPH																
9 5/8	15 3/8	2	TRIUMPH		VT	C	3	12	GR GR	2 1/4 2 1/4	15 7/8 15 7/8	C C		A A	N	124920
9 7/8	21 7/16	2	TRIUMPH		VT	C	3	14	GR GR	2 1/4 2 1/4	22 1/8 22 1/8	C C		A A	N	128490
10	21 3/8	1 1/2	TRIUMPH		T	C	2	10	GR GR	2 5/16 2 5/16	22 1/4 22 1/4	C C		A A	N	263207
12 3/4	12 5/8	2 5/8	TRIUMPH		VT	C	4	12		3 1/4 3 1/4	12 3/4 12 3/4	C C		0 0	N	128376
14 1/2	21 7/16	2	TRIUMPH		VT	C	3	12	GR GR	2 3/4 2 3/4	21 3/4 21 3/4	C C		A A	N	124588
15 1/4	12 5/8	1 1/4	TRIUMPH		VT	C	2	16	GR GR	2 2	12 3/8 12 3/8	C C		A A	N	128126
16 3/8	16 1/4	1 7/8	TRIUMPH		X	C	2	11	GR GR	2 3/4 2 3/4	16 1/2 16 1/2	C C		A A	N	265414
16 3/8	16 5/16	2 1/4	TRIUMPH		T	C	3	11	GR GR	2 3/4 2 3/4	16 1/2 16 1/2	C C		A A	N	264347
16 3/8	16 1/2	2	TRIUMPH		VT	C	3	12	GR GR	2 3/4 2 3/4	16 1/2 16 1/2	C C		A A	N	124805
16 3/8	16 1/2	2 5/8	TRIUMPH		VT	C	4	12	FR FR	2 3/4 2 3/4	16 1/2 16 1/2	C C		A A	N	128644
16 7/8	12 3/8	3	TRIUMPH		T	C	4	11	GR GR	3 1/4 3 1/4	12 3/4 12 3/4	C C		A A	N	260524
17 1/8	12 3/8	3	TRIUMPH		T	C	4	9		3 3/8 3 3/8	12 7/8 12 7/8	C C		0 0	N	264250
17 3/8	16 5/16	2 1/4	TRIUMPH		T	C	3	11	GR GR	2 1/2 2 1/2	17 17	C C		A A	N	265415
18 3/8	16 5/16	2 1/4	TRIUMPH		T	C	3	11	GR GR	2 3/4 2 3/4	16 1/2 16 1/2	C C		A A	N	263625
18 1/2	16 1/2	2	TRIUMPH		VT	C	3	12	GR GR	2 3/4 2 3/4	16 1/2 16 1/2	C C		A A	N	128367
20 13/16	14 7/8	1	TRIUMPH		VE	C	2	16		1 15/16 1 15/16	15 3/4 15 3/4	C C		0 0	N	122431
21 1/8	15 3/8	1 1/4	TRIUMPH		VT	C	2	16	GR GR	2 1/4 2 1/4	15 7/8 15 7/8	C C		0 A	N	128454
21 1/2	15	1 3/4	TRIUMPH		R	C	3	11	GR GR	2 3/8 2 3/8	16 16	C C		A A	N	266373
21 1/2	15 3/8	2	TRIUMPH		VT	C	3	12	GR GR	2 3/8 2 3/8	16 16	C C		A A	N	124875
TRUCK & BUS HEATER																
12	10 5/8	2 7/8	TRUCK AND BUS HEATER	CARPENTER, THOMAS	R	C	5	11	GR GR	3 1/4 3 1/4	10 1/2 10 1/2	C C		A A	N	226712
13 3/8	9 3/8	1 3/4	TRUCK AND BUS HEATER	BLUEBIRD 0557637	R	C	3	7	GR GR	2 1/2 2 1/2	9 9	1/4 1/4		A A	N	226715
17 1/4	8 3/4	2 3/8	TRUCK AND BUS HEATER	THOMAS, CARPENTER 10472	R	C	4	11	GR GR	2 1/2 2 1/2	9 9	C C		A A	N	226718

Vista-Pro Automotive - Core Catalog

(Cores Sorted by Application)

Height	Width	Depth	Application	Description	Fin Type	Fin Matl	Rows	FPI	BH/TH Type	BH/TH Width	BH/TH Length	BH/TH OHF	BH/TH Bolts	BH/TH Shape	Hdr Support	Part #
TRUCK & BUS HEATER (Cont)																
20 1/4	8 3/4	3 7/16	TRUCK AND BUS HEATER	SUPERIOR 331085	R	C	6	10	GR GR	4 4	8 3/4 8 3/4	C C		A A	N	226722
20 1/4	10 5/8	2 7/8	TRUCK AND BUS HEATER	THOMAS, CARPENTER	R	C	5	11	GR GR	3 3/8 3 3/8	10 3/4 10 3/4	C C		A A	N	226723
20 3/4	10 5/8	3 7/16	TRUCK AND BUS HEATER	WARD	R	C	6	11		4 1/8 4 1/8	10 3/4 10 3/4	C C		0 0	N	226724
20 3/4	11 1/4	2 7/8	TRUCK AND BUS HEATER	WAYNE	R	C	5	11	FR FR	3 3	11 11	C C		0 0	N	226725
22 1/2	10 5/8	2 7/8	TRUCK AND BUS HEATER	BLUEBIRD 0556050	R	C	5	11		3 1/4 3 1/4	10 5/8 10 5/8	C C		0 0	N	226726
27 1/4	9 3/8	1 3/4	TRUCK AND BUS HEATER	BLUEBIRD BUS 0557629	R	C	3	7	GR GR	2 1/2 2 1/2	9 9	1/4 1/4		A A	C	226730
V.M.E.																
29	34 5/16	4 1/2	V.M.E.	TS-24 HVY BTM HDR	T	C	6	7	BL BH	7 1/2 7 1/2	38 38	C C	48 48	A A	C	273289
42 7/8	42 1/2	5 3/16	V.M.E.	VOLVO MICHIGAN LOADER HVY T/BTM HDRS BRASS FINIS	Z	B	7	9	BH BH	9 3/8 8 3/8	44 7/8 44 7/8	C C	58 58	A A	CC	285221
44	47 1/4	4 1/2	V.M.E.	R-50 HAUL TRUCK HVY T/BTM HDRS	T	C	6	7	BH BH	8 1/2 8 1/2	51 7/8 51 7/8	C C	50 50	H H	CC	223594
48 1/2	37 1/8	5 1/4	V.M.E.	MICHIGAN 275 HVY T/BTM HDRS	T	C	7	8	BH BH	9 1/4 8 1/4	40 40	C C	52 52	A A	C	223310
VALIANT																
16 3/4	18 11/16	1 1/4	VALIANT		VT	C	2	12	BU GR	4 1 3/4	19 1/4 18 1/2	C C		A A	N	122287
16 3/4	19 1/4	1 1/4	VALIANT		VT	C	2	12	BU GR	4 1 3/4	19 1/4 19	C C		A A	N	122285
16 7/8	22	2	VALIANT		VT	C	3	12	GR GR	3 3/8 2 1/4	21 5/8 21 5/8	C C		A A	N	124771
17	18 11/16	1 1/4	VALIANT		VT	C	2	12	BU GR	4 1 3/4	19 1/4 18 1/2	C C		A A	N	122500
17	19 1/4	1 1/4	VALIANT		VT	C	2	12	BU GR	4 1 3/4	19 1/4 19	C C		A A	N	122425
17 1/8	22	1 1/4	VALIANT		VT	C	2	12	BU GR	4 2	22 1/4 21 3/4	C C		A A	N	122439
17 1/4	22	1 1/4	VALIANT		VT	C	2	14	BU GR	4 2	22 1/4 21 3/4	3/16 3/16		A A	N	124637
17 1/2	18 11/16	1 1/4	VALIANT		VT	C	2	12	BU GR	4 1 3/4	19 1/4 18 1/2	FF FF		A A	N	122553
VEGA																
12	11 9/16	1 1/4	VEGA		VT	C	2	14	GR GR	2 2	13 3/16 13 3/16	C C		A A	N	124562
20 3/4	11 9/16	1 1/4	VEGA		VT	C	2	13	GR GR	2 2 3/4	13 3/16 13 3/16	C C		A A	N	124563
VOLKSWAGEN																
21 3/8	12 5/8	2	VOLKSWAGEN		VT	C	3	14		2 3/16 2 3/16	12 11/16 12 11/16	C C		0 0	N	128491
VOLVO																
12 1/2	19 1/4	2	VOLVO		VT	C	3	12	GR GR	4 3/8 2 1/4	19 3/4 19 3/4	C C		A A	N	124877
12 1/2	19 13/16	2	VOLVO		VT	C	3	14	GR GR	2 1/4 2 1/4	19 5/8 19 5/8	C C		A A	N	124801
12 1/2	19 13/16	2	VOLVO		VT	C	3	14		2 1/8 2 5/16	19 1/2 19 1/2	C C		0 0	N	128275

Vista-Pro Automotive - Core Catalog

(Cores Sorted by Application)

Height	Width	Depth	Application	Description	Fin Type	Fin Matl	Rows	FPI	BH/TH Type	BH/TH Width	BH/TH Length	BH/TH OHF	BH/TH Bolts	BH/TH Shape	Hdr Support	Part #
VOLVO (Cont)																
15 1/4	23 1/8	1 1/4	VOLVO		VT	C	2	12	GR	2 3/8	23 5/8	C		A	N	128678
									GR	2 3/8	23 5/8	C		A		
15 1/2	23 1/8	2	VOLVO		VT	C	3	12	GR	2 1/4	23 1/2	C		A	N	122471
									GR	2 1/4	23 1/2	C		A		
17 5/8	16 1/2	1 1/4	VOLVO		VT	C	2	12	GR	2 7/16	17 5/16	C		A	N	124684
									GR	2 7/16	17 5/16	C		A		
17 5/8	16 1/2	2	VOLVO		VT	C	3	12	GR	2 7/16	17 5/16	C		A	N	124715
									GR	2 7/16	17 5/16	C		A		
17 11/16	17 5/8	2	VOLVO		VT	C	3	14	GR	2 7/16	17 5/16	C		A	N	128395
									GR	2 7/16	17 5/16	C		A		
23 1/4	16 1/2	1 1/4	VOLVO		VT	C	2	12	GR	2 7/16	17 5/16	C		A	N	128155
									GR	2 7/16	17 5/16	C		A		
23 1/4	16 1/2	2	VOLVO		VT	C	3	14	GR	2 7/16	17 5/16	C		A	N	128171
									GR	2 7/16	17 5/16	C		A		
25	27 1/2	3	VOLVO TRUCK		VH	C	4	16	BL	7	30 3/8	1 3/4	42	A	N	251139
									BL	7	30 3/8	1 3/4	42	A		
25 1/2	22 1/2	2 7/8	VOLVO WHITEGMC		R	C	5	11	GR	3 1/4	22 3/4	C		A	C	226732
									GR	3 1/4	22 3/4	C		A		
27 3/8	22	2 5/8	VOLVO WHITEGMC		VT	C	4	12	GR	3 7/16	22 1/4	C		A	N	128896
									GR	3 7/16	22 1/4	C		A		
27 5/8	26 7/8	2 7/8	VOLVO WHITEGMC	716	R	C	5	11	SQ	3 7/16	27	C		A	C	226733
									SQ	3 7/16	27	C		A		
29	40 1/2	2 1/4	VOLVO/GM LO-FLOW VH	LOW FLOW DIMPLED TUBE	VH	C	3	15	BL	7	43 3/8	2	56	A	N	251017
									BL	7	43 3/8	C	56	A		
29	40 5/8	2 3/8	VOLVO WHITEGMC	LOW FLOW DIMPLED TUBE	R	C	4	11	BL	7	43 3/8	C	56	A	CC	226007
									BL	7	43 3/8	C	56	A		
29	40 5/8	2 7/8	VOLVO WHITEGMC	AERO	R	C	5	10	BL	7	43 3/8	2 1/2	56	A	CC	226736
									BL	7	43 3/8	2 1/2	56	A		
31 3/4	40 7/16	1 1/2	VOLVO/GM	SEE 251122	VTH	C	2	16	BL	7	43 3/8	2 13/16	56	A	N	253122
									BL	7	43 3/8	2 13/16	56	A		
31 3/4	40 7/16	1 1/2	VOLVO/GM	SEE 251008 DIMPLED TUBE	VTH	C	2	16	BL	7	43 3/8	2 13/16	56	A	N	253008
									BL	7	43 3/8	2 13/16	56	A		
31 3/4	40 7/16	2 1/4	VOLVO/GM	SEE 251122	VTH	C	3	14	BL	7	43 3/8	2 13/16	56	A	N	252122
									BL	7	43 3/8	2 13/16	56	A		
31 3/4	40 1/2	2 1/4	VOLVO WHITEGMC	AERO ULTRA-FUSED LOW FLOW CAN USE 251008 DIMPLED TUBE	VH	C	3	15	BL	7	43 3/8	2 13/16	56	A	N	284749
									BL	7	43 3/8	2 13/16	56	A		
31 3/4	40 1/2	2 1/4	VOLVO/GM	AERO CAN USE 226107	VH	C	3	14	BL	7	43 3/8	2 13/16	56	A	N	251122
									BL	7	43 3/8	2 13/16	56	A		
31 3/4	40 1/2	2 1/4	VOLVO/GM	LOW FLOW CAN USE 284749 DIMPLED TUBE	VH	C	3	15	BL	7	43 3/8	2 13/16	56	A	N	251008
									BL	7	43 3/8	2 13/16	56	A		
31 3/4	40 5/8	2 3/8	VOLVO TRUCK	DIMPLED TUBE	R	C	4	11	BL	7	43 3/8	2 13/16	56	0	CC	225964
									BL	7	43 3/8	2 13/16	56	A		
31 3/4	40 5/8	2 3/8	VOLVO WHITEGMC	LOW FLOW CAN USE 284749 DIMPLED TUBE	R	C	4	11	BL	7	43 3/8	2 13/16	56	A	CC	226010
									BL	7	43 3/8	2 13/16	56	A		
31 3/4	40 5/8	2 3/8	VOLVO WHITEGMC	AERO	R	C	4	11	BL	7	43 3/8	C	56	A	CC	226107
									BL	7	43 3/8	C	56	A		
31 3/4	40 7/16	2 1/4	VOLVO		VTH	C	3	14	BL	7	43 3/8	2 13/16	56	A	N	252008
									BL	7	43 3/8	2 13/16	56	A		
33 1/2	26 7/8	1 3/4	VOLVO WHITEGMC		R	C	3	11	SQ	3 1/2	27	FF		A	C	226743
									SQ	3 1/2	27	FF		A		
35 3/8	35	1 3/4	VOLVO WHITEGMC	ROAD BOSS 1100722	R	C	3	11	BL	7	37 7/8	2 7/16	50	A	C	226744
									BL	7	37 7/8	2 7/16	50	A		
35 3/8	35	2 3/8	VOLVO WHITEGMC	ROAD BOSS	R	C	4	11	BL	7	37 7/8	2 7/16	50	A	C	226746
									BL	7	37 7/8	2 7/16	50	A		

Vista-Pro Automotive - Core Catalog

(Cores Sorted by Application)

Height	Width	Depth	Application	Description	Fin Type	Fin Matl	Rows	FPI	BH/TH Type	BH/TH Width	BH/TH Length	BH/TH OHF	BH/TH Bolts	BH/TH Shape	Hdr Support	Part #
VOLVO (Cont)																
35 3/8	35	2 7/8	VOLVO WHITEGMC	ROAD BOSS	R	C	5	11	BL	7	37 7/8	2 7/16	50	A	C	226745
									BL	7	37 7/8	2 7/16	50	A		
35 1/2	40 5/8	2 3/8	VOLVO WHITEGMC	ROAD BOSS LOW FLOW CAN USE 284771 DIMPLED TUBE	R	C	4	11	BL	7	43 3/8	2 13/16	56	A	CC	226020
									BL	7	43 3/8	2 13/16	56	A		
35 1/2	40 5/8	2 7/8	VOLVO WHITEGMC	ROAD BOSS	R	C	5	10	BL	7	43 3/8	2 1/2	56	A	CC	226750
									BL	7	43 3/8	2 1/2	56	A		
35 5/8	35	2 7/8	VOLVO TRUCK		R	C	5	11	BL	7	37 7/8	2 1/2	50	A	C	226573
									BL	7	37 7/8	2 1/2	50	A		
38	27 1/2	1 3/4	VOLVO WHITEGMC	ROAD BOSS HVY BTM HDR	R	C	3	11	BL	7	30 3/8	2 1/2	42	A	C	226753
									BH	7	30 3/8	2 1/2	42	A		
38	27 1/2	2 3/8	VOLVO WHITEGMC	ROAD BOSS HVY BTM HDR	R	C	4	11	BL	7	30 3/8	2 1/2	42	A	C	226754
									BH	7	30 3/8	2 1/2	42	A		
38	27 1/2	2 7/8	VOLVO WHITEGMC	ROAD BOSS HVY BTM HDR	R	C	5	11	BL	7	30 3/8	1 3/4	42	A	C	226751
									BH	7	30 3/8	1 3/4	42	A		
38	27 1/2	3 7/16	VOLVO WHITEGMC	ROAD BOSS HVY BTM HDR	R	C	6	11	BL	7	30 3/8	1 7/8	42	A	C	226755
									BH	7	30 3/8	1 7/8	42	A		
38	27 1/2	3 3/4	VOLVO TRUCK	ROAD BOSS 14" X 5" CRANK BOX OFFSET ON BH	B	C	5	10	BL	7	30 3/8	C	42	A	C	229652
									BL	7	30 3/8	C	42	A		
38	27 1/2	3 3/4	VOLVO TRUCK	ROAD BOSS 14" X 5" CRANK BOX OFFSET ON BH	B	C	5	10	BL	7	30 3/8	C	42	A	C	229652
									BL	7	30 3/8	C	42	A		
38	27 1/2	3 3/4	VOLVO TRUCK	ROAD BOSS 14" X 5" CRANK BOX OFFSET ON BH	B	C	5	10	BL	7	30 3/8	C	42	A	C	229652
									BL	7	30 3/8	C	42	A		
38	27 1/2	3 3/4	VOLVO TRUCK	ROAD BOSS 14" X 5" CRANK BOX CTRD ON BH	B	C	5	10	BL	7	30 3/8	C	42	A	C	229655
									BL	7	30 3/8	C	42	A		
38	27 1/2	3 3/4	VOLVO TRUCK	ROAD BOSS LOW FLOW 14" X 5" CRANK BOX CTRD ON BH DIMPLED TUBE	B	C	5	10	BL	7	30 3/8	C	42	A	C	229658
									BL	7	30 3/8	C	42	A		
38	27 1/2	3 3/4	VOLVO TRUCK	ROAD BOSS LOW FLOW 14" X 5" CRANK BOX OFFSET ON BH DIMPLED TUBE	B	C	5	10	BL	7	30 3/8	C	42	A	C	229657
									BL	7	30 3/8	C	42	A		
38	27 1/2	3 3/4	VOLVO WHITEGMC	ROAD BOSS	B	C	5	10	BL	7	30 3/8	C	42	A	C	260562
									BL	7	30 3/8	C	42	A		
38	29 3/8	2 7/8	VOLVO WHITEGMC	ROAD BOSS HVY BTM HDR 4 CRNRS OF CORE NOTCHED	R	C	5	11	BL	7	30 3/8	2 1/2	42	A	C	226758
									BH	7	30 3/8	2 1/2	42	A		
38	29 3/8	3 7/16	VOLVO WHITEGMC	ROAD BOSS HVY BTM HDR 4 CRNRS OF CORE NOTCHED	R	C	6	11	BL	7	30 3/8	C	42	A	C	226759
									BH	7	30 3/8	C	42	A		
38	34 3/4	2 1/4	VOLVO WHITEGMC	20001-8898 ULTRA-FUSED LOW FLOW CAN USE 251029 DIMPLED TUBE	VH	C	3	16	BL	7	37 7/8	1 7/8	50	A	N	284691
									BL	7	37 7/8	1 7/8	50	A		
38	34 3/4	3	VOLVO WHITEGMC	20002-5059 ULTRA-FUSED LOW FLOW CAN USE 251032 DIMPLED TUBE	VH	C	4	16	BL	7	37 7/8	2 1/8	50	A	N	284690
									BL	7	37 7/8	2 1/8	50	A		
38	34 7/8	3	VOLVO WHITEGMC	ROAD COMMANDER	T	C	4	9	BL	7	37 7/8	2 1/2	50	A	C	265601
									BL	7	37 7/8	2 1/2	50	A		
38	34 15/16	2 1/4	VOLVO/GM LO-FLOW VH	SEE 251029 DIMPLED TUBE	VTH	C	3	15	BL	7	37 7/8	1 7/8	50	A	N	252029
									BL	7	37 7/8	1 7/8	50	A		
38	35	1 3/4	VOLVO TRUCK	ROAD BOSS II 2 PASS HIGH FLOW W/BAFFLE HVY BTM HDR	R	C	3	11	BL	7	37 7/8	2 5/8	50	A	C	226286
									BH	7	37 7/8	2 5/8	50	A		
38	35	1 3/4	VOLVO WHITEGMC	ROAD BOSS II 1100712 HVY BTM HDR	R	C	3	11	BL	7	37 7/8	2 5/8	50	A	C	226760
									BH	7	37 7/8	2 5/8	50	A		
38	35	2 1/4	VOLVO/GM LO-FLOW VH	ROAD BOSS II LOW FLOW CAN USE 284691 DIMPLED TUBE	VH	C	3	15	BL	7	37 7/8	1 7/8	50	A	N	251029
									BL	7	37 7/8	1 7/8	50	A		
38	35	2 3/8	VOLVO WHITEGMC	ROAD BOSS II LOW FLOW CAN USE 284691 DIMPLED TUBE	R	C	4	11	BL	7	37 7/8	1 7/8	50	A	C	226024
									BL	7	37 7/8	1 7/8	50	A		
38	35	2 3/8	VOLVO WHITEGMC	ROAD BOSS II HVY BTM HDR	R	C	4	11	BL	7	37 7/8	2 5/8	50	A	C	226761
									BH	7	37 7/8	2 5/8	50	A		

Vista-Pro Automotive - Core Catalog

(Cores Sorted by Application)

Height	Width	Depth	Application	Description	Fin Type	Fin Matl	Rows	FPI	BH/TH Type	BH/TH Width	BH/TH Length	BH/TH OHF	BH/TH Bolts	BH/TH Shape	Hdr Support	Part #
VOLVO (Cont)																
38	35	2 7/8	VOLVO WHITEGMC	ROAD BOSS II 20002-5059 LOW FLOW CAN USE 284690 DIMPLED TUBE	R	C	5	11	BL BL	7 7	37 7/8 37 7/8	2 1/8 2 1/8	50 50	A A	C	226029
38	35	2 7/8	VOLVO WHITEGMC	ROAD BOSS II HVY BTM HDR	R	C	5	11	BL BH	7 7	37 7/8 37 7/8	2 5/8 2 5/8	50 50	A A	C	226762
38	35	3	VOLVO/GM	ROAD BOSS II 20002-5059 LOW FLOW CAN USE 284690 DIMPLED TUBE	VH	C	4	15	BL BL	7 7	37 7/8 37 7/8	2 1/8 2 1/8	50 50	A A	N	251032
38	35	3 7/16	VOLVO WHITEGMC	HVY BTM HDR	R	C	6	11	BL BH	7 7	37 7/8 37 7/8	1 15/16 1 15/16	50 50	A A	C	226763
38	35 7/16	3	VOLVO WHITEGMC	HVY BTM HDR	T	C	4	11	BL BH	7 7	37 7/8 37 7/8	1 5/8 1 5/8	50 50	A A	C	265680
38	35 5/8	2 3/8	VOLVO WHITEGMC	ROAD BOSS II HVY BTM HDR	R	C	4	11	BL BH	7 7	37 7/8 37 7/8	2 7/16 2 7/16	50 50	A A	C	226765
38	37 1/2	1 3/4	VOLVO WHITEGMC	ROAD BOSS 1100712 HVY BTM HDR	R	C	3	11	BL BH	7 7	37 7/8 37 7/8	2 5/8 2 5/8	50 50	A A	C	226766
38	37 1/2	2 3/8	VOLVO WHITEGMC	ROAD BOSS 1100713 HVY BTM HDR	R	C	4	11	BL BH	7 7	37 7/8 37 7/8	2 5/8 2 5/8	50 50	A A	C	226768
38	37 1/2	2 7/8	VOLVO WHITEGMC	ROAD BOSS 1100714 HVY BTM HDR	R	C	5	11	BL BH	7 7	37 7/8 37 7/8	2 5/8 2 5/8	50 50	A A	C	226767
38	40 5/8	2 7/8	VOLVO WHITEGMC	ROAD BOSS HVY BTM HDR	R	C	5	10	BL BH	7 7	43 3/8 43 3/8	2 1/2 2 1/2	56 56	A A	CC	226770
38 3/8	29 3/8	2 7/8	VOLVO WHITEGMC	ROAD COMMANDER TEMPLATE #20	R	C	5	9	BL BL	10 3/8 6	31 1/4 31 1/4	3 1 3/4	54 42	B B	C	226771
38 9/16	26 7/8	2 3/8	VOLVO TRUCK	WG64T 5/8 RADIUS	R	C	4	11	GR GR	3 7/16 3 7/16	27 27	C C	A A	C	226483	
43 3/8	35	2 7/8	VOLVO WHITEGMC	ROAD BOSS II 1100717 HVY BTM HDR	R	C	5	11	BL BH	7 7	37 7/8 37 7/8	2 5/8 2 5/8	50 50	A A	C	226772
43 3/8	35	3 7/16	VOLVO WHITEGMC	ROAD BOSS II 1100718 HVY BTM HDR	R	C	6	11	BL BH	7 7	37 7/8 37 7/8	1 15/16 1 15/16	50 50	A A	C	226774
VOSS BUS																
30 1/8	16 7/8	4 7/16	VOSS BUS	DIMPLED TUBE	R	C	8	11	BL BL	7 3/4 7 3/4	18 1/2 18 1/2	C C	30 30	A A	C	226867
WABCO																
36 3/4	47 13/16	4 1/2	WABCO	VY-7099, 222G HVY T/BTM HDRS	T	C	6	8	BH BH	9 3/8 9 3/8	51 51	C C	64 64	A A	CC	272717
WAGONER TRACTOR																
31 1/8	38 1/8	4 5/8	WAGONER TRACTOR	WC-17 COMPACTOR HVY T/BTM HDRS	X	C	6	11	BH BH	8 7/8 8 7/8	39 3/8 39 3/8	1 3/4 1 3/4	52 52	A A	C	266203
WARD LaFRANCE																
35 1/4	25	2 7/8	WARD La FRANCE		R	C	5	11	GR GR	5 7/8 4 3/8	25 7/8 25 7/8	2 1/2 C	A A	C	226779	
WAUKESHA																
19 1/8	19 3/8	2 1/4	WAUKESHA	T/HDR RD FRONT	X	C	3	9	GR GR	5 7/8 3 1/2	21 1/4 19 7/8	2 C	A A	N	288197	
21 1/2	21 1/4	3	WAUKESHA		X	C	4	8	GR GR	5 7/8 3 1/4	22 1/16 22 1/16	1/4 C	A A	N	286629	
22 1/2	21 3/8	3	WAUKESHA		T	C	4	8	GR GR	5 7/8 3 1/4	22 1/16 22 1/16	1/8 1/8	A A	N	279957	
22 5/8	20 13/16	3	WAUKESHA	GL-190	T	C	4	8	BL BL	5 3/4 5 3/4	24 24	C C	36 36	A A	C	272531
22 5/8	21 3/8	2 1/4	WAUKESHA	VRG-155, VRD-232	T	C	3	9	GR GR	5 7/8 3 7/16	21 3/4 21 3/4	1/4 1/4	A A	N	272529	
22 5/8	21 3/8	3	WAUKESHA	VRD-232	T	C	4	8	GR GR	5 7/16 3 7/16	21 3/4 21 3/4	1/8 1/8	A A	N	272530	

Vista-Pro Automotive - Core Catalog

(Cores Sorted by Application)

Height	Width	Depth	Application	Description	Fin Type	Fin Matl	Rows	FPI	BH/TH Type	BH/TH Width	BH/TH Length	BH/TH OHF	BH/TH Bolts	BH/TH Shape	Hdr Support	Part #
WAUKESHA (Cont)																
22 3/4	20 13/16	3	WAUKESHA	190	T	C	4	7	BL BL	5 5/8 5 5/8	24 24	C C	36 36	A A	C	266620
22 3/4	21 7/8	2 15/16	WAUKESHA	VRG-310	Z	C	4	10	GR GR	6 3 1/2	22 22	1/4 1/4		A A	N	286909
23	21 3/8	3	WAUKESHA		T	C	4	10	GR GR	6 3 1/2	22 22	1/4 1/4		A A	N	265653
26 5/8	24 3/8	3	WAUKESHA	MZ	X	C	4	7	BL BL	6 5/8 6 5/8	27 1/4 27 1/4	C C	32 32	H H	C	274897
26 5/8	24 3/4	3 3/4	WAUKESHA	GK-135	T	C	5	7	BL BL	6 5/8 6 5/8	27 1/4 27 1/4	C C	32 32	H H	C	223316
27	21 1/4	2 7/8	WAUKESHA		S	C	5	10	BL BL	5 3/8 5 3/8	24 24	C C	30 30	A A	C	272962
27	21 3/8	3	WAUKESHA	VGR-220, VGR-330	T	C	4	8	BL BL	5 3/8 5 3/8	24 24	C C	36 36	A A	C	272533
28 1/2	27 9/16	3	WAUKESHA	SCANIA HVY BTM HDR	T	C	4	8	BL BH	6 1/4 6 1/4	30 1/2 30 1/2	C C	42 42	A A	C	272534
30	26 7/8	3	WAUKESHA	GK-140	X	C	4	7	BL BL	7 1/4 7 1/4	30 30	C C	36 36	H H	C	274842
30	26 7/8	3 11/16	WAUKESHA	GK-140	Z	C	5	8	BL BL	7 1/4 7 1/4	30 30	1 1/4 1 1/4	36 36	H H	C	282090
30	27	3 3/4	WAUKESHA	GK-140, MD1554	T	C	5	7	BL BL	7 1/4 7 1/4	30 30	C C	36 36	H H	C	270504
36	32 1/2	4 7/16	WAUKESHA	F-817 HVY BTM HDR BRASS FINS	Z	B	6	9	BL BH	8 3/8 8 3/8	36 36	C C	46 46	A A	C	288902
36	33 1/8	3	WAUKESHA	GK-145	X	C	4	7	BL BL	7 1/4 7 1/4	36 36	C C	36 36	H H	C	274843
36	33 3/16	3 3/4	WAUKESHA	GK-145	T	C	5	7	BL BL	7 1/4 7 1/4	36 36	1 3/8 1 3/8	36 36	H H	C	223300
36	33 3/4	3 3/4	WAUKESHA	HVY BTM HDR	X	C	5	8	BL BH	8 3/8 8 3/8	36 36	C C	46 46	A A	C	289848
38	33 3/16	4 1/2	WAUKESHA	F-2896 HVY T/BTM HDRS 4 CORES PER RAD	T	C	6	8	BH BH	7 5/8 7 5/8	35 5/8 35 5/8	C C	44 44	A A	C	272542
45	45	3 3/4	WAUKESHA	DDV-75,C71 HVY T/BTM HDRS	T	C	5	9	BH BH	7 1/4 7 1/4	47 1/2 47 1/2	C C	54 54	A A	CC	272954
50 3/4	35	4 7/16	WAUKESHA	WAK BRASS FINS W/ BRASS CTR TANK	Z	B	6	9	BL BL	9 1/4 9 1/4	39 1/2 39 1/2	1 5/8 1 5/8	42 42	A A	C	289877
WESTERN STAR																
31	35	3	WESTERN STAR	LOW FLOW NEW VH CONSTRUCTION DIMPLED TUBE	VH	C	4	15	BL BL	6 11/16 6 11/16	38 38	C C	46 46	A A	N	251005
31	35 5/8	2 7/8	WESTERN STAR	LOW FLOW DIMPLED TUBE	R	C	5	11	BL BL	6 5/8 6 5/8	37 7/8 37 7/8	C C	46 46	A A	C	226042
31 5/8	28 3/4	1 3/4	WESTERN STAR	TEMPLATE #20	R	C	3	10	BL BL	10 3/8 6	31 1/4 31 1/4	3 1/8 C	54 42	B B	C	226781
31 5/8	29 3/8	1 3/4	WESTERN STAR	TEMPLATE #20	R	C	3	10	BL SQ	10 3/8 6	31 1/4 31 1/4	3 1/8 C	54 40	B A	C	226780
31 5/8	29 3/8	2 3/8	WESTERN STAR	TEMPLATE #20	R	C	4	10	BL BL	10 3/8 6	31 1/4 31 1/4	2 3/4 C	54 42	B B	C	226782
31 5/8	29 3/8	2 7/8	WESTERN STAR	TEMPLATE #20	R	C	5	10	BL BL	10 3/8 6	31 1/4 31 1/4	3 1 3/4	54 42	B B	C	226784
32 1/2	34 3/4	2 1/4	WESTERN STAR	ULTRA-FUSED CAN USE 226151	VH	C	3	13	BL BL	7 6 5/8	37 7/8 37 7/8	2 1/4 2 1/4	46 46	A A	N	284531
32 1/2	35	2 1/4	WESTERN STAR	CAN USE 226151	VH	C	3	14	BL BL	7 6 5/8	37 7/8 37 7/8	2 1/4 2 1/4	46 46	A A	N	251119

Vista-Pro Automotive - Core Catalog

(Cores Sorted by Application)

Height	Width	Depth	Application	Description	Fin Type	Fin Matl	Rows	FPI	BH/TH Type	BH/TH Width	BH/TH Length	BH/TH OHF	BH/TH Bolts	BH/TH Shape	Hdr Support	Part #
WESTERN STAR (Cont)																
32 1/2	35 1/2	3	WESTERN STAR	CORNERSTONE LOW FLOW DIMPLED TUBE	VH	C	4	15	BL	7	37 7/8	C	46	A	N	251018
									BL	6 5/8	37 7/8	C	46	A		
32 1/2	35 5/8	2 3/8	WESTERN STAR	CORNERSTONE	R	C	4	11	BL	7	38	2 1/4	46	A	C	226151
									BL	6 5/8	38	2 1/4	46	A		
32 1/2	35 5/8	2 7/8	WESTERN STAR	CORNERSTONE LOW FLOW DIMPLED TUBE	R	C	5	11	BL	7	38	C	46	A	C	226008
									BL	6 5/8	38	C	46	A		
32 1/2	35 5/8	2 7/8	WESTERN STAR	CORNERSTONE	R	C	5	11	BL	7	37 7/8	C	46	A	C	226786
									BL	6 5/8	37 7/8	C	46	A		
32 1/2	36 1/4	2 3/8	WESTERN STAR	TEMPLATE #19	R	C	4	11	BL	12 1/2	37 7/8	1 7/8	52	A	C	226787
									BL	6 5/8	37 7/8	1 7/8	46	A		
32 1/2	36 1/4	2 7/8	WESTERN STAR	TEMPLATE #19	R	C	5	11	BL	12 1/2	37 7/8	1 7/8	52	A	C	226788
									BL	6 5/8	37 7/8	1 7/8	46	A		
34	34 3/4	3	WESTERN STAR	CORNERSTONE CAN USE 226193	VH	C	4	14	BL	6 5/8	37 7/8	C	46	A	N	284040
									BL	6 5/8	37 7/8	C	46	A		
34	34 3/4	3	WESTERN STAR	CORNERSTONE ULTRA-FUSED LOW FLOW CAN USE 251039	VH	C	4	13	BL	6 5/8	37 7/8	C	46	A	N	284060
									BL	6 5/8	37 7/8	C	46	A		
34	34 15/16	2 1/4	WESTERN STAR	SEE 251129	VTH	C	3	16	BL	6 5/8	37 7/8	C	46	A	N	253129
									BL	6 5/8	37 7/8	C	46	A		
34	34 15/16	3	WESTERN STAR	SEE 251129	VTH	C	4	14	BL	6 5/8	37 7/8	C	46	A	N	252129
									BL	6 5/8	37 7/8	C	46	A		
34	35	3	WESTERN STAR	CORNERSTONE LOW FLOW CAN USE 284060	VH	C	4	15	BL	6 5/8	37 7/8	C	46	A	N	251039
									BL	6 5/8	37 7/8	C	46	A		
34	35	3	WESTERN STAR	CORNERSTONE CAN USE 226193	VH	C	4	14	BL	6 5/8	37 7/8	C	46	A	N	251129
									BL	6 5/8	37 7/8	C	46	A		
34	35 5/8	2 7/8	WESTERN STAR	CORNERSTONE LOW FLOW DIMPLED TUBE	R	C	5	11	BL	6 5/8	37 7/8	C	46	A	C	226039
									BL	6 5/8	37 7/8	C	46	A		
34	35 5/8	2 7/8	WESTERN STAR	CORNERSTONE	R	C	5	11	BL	6 5/8	37 7/8	C	46	A	C	226193
									BL	6 5/8	37 7/8	C	46	A		
35	29 1/4	3	WESTERN STAR	9000 SERIES TEMPLATE #20	T	C	4	10	BL	10 3/8	31 1/4	2 7/16	54	B	C	263877
									BL	6	31 1/4	1 13/16	42	B		
35 1/8	29 3/8	2 3/8	WESTERN STAR	TEMPLATE #20	R	C	4	10	BL	10 3/8	31 1/4	2 7/8	54	B	C	226790
									BL	6	31 1/4	C	42	B		
39 1/8	36 9/16	3	WESTERN STAR	TEMPLATE #19	T	C	4	10	BL	12 1/2	37 7/8	1 7/8	52	A	C	265452
									BL	6 5/8	37 7/8	C	46	A		
39 1/8	36 7/8	2 7/8	WESTERN STAR	4 CRNRS OF CORE NOTCHED	R	C	5	9	BL	7	37 15/16	2 1/8	46	A	C	226792
									BL	6 5/8	37 15/16	1 7/8	46	A		
39 1/4	36 7/8	2 7/8	WESTERN STAR	TEMPLATE #19 4 CRNRS OF CORE NOTCHED	R	C	5	10	BL	12 1/2	37 7/8	1 7/8	52	A	C	226793
									BL	6 5/8	37 7/8	C	46	B		
39 1/4	36 7/8	2 7/8	WESTERN STAR	TEMPLATE #19 4 CRNRS OF CORE NOTCHED	R	C	5	9	BL	12 1/2	37 7/8	1 7/8	52	A	C	226794
									BL	6 5/8	37 7/8	C	46	A		
WHITE TRACTOR																
18	22 1/2	3	WHITE TRACTOR	3014	T	C	4	8	GR	3 1/4	22 1/2	C		A	N	260298
									GR	3 1/4	22 1/2	C		A		
22 1/8	21 1/4	3 3/4	WHITE TRACTOR	FARM TRACTOR	X	C	5	10	GR	6	21 7/8	C		A	N	282661
									GR	4	21 7/8	3/16		A		
WILLYS																
15 1/2	24 3/16	1 1/4	WILLYS		VT	C	2	12	GR	2 7/8	24 1/4	1/8		A	N	124836
									GR	2 7/8	24 1/4	1/8		A		
15 1/2	24 3/16	2	WILLYS		VT	C	3	13	GR	2 7/8	24 1/4	1/8		A	N	124837
									GR	2 7/8	24 1/4	1/8		A		
15 5/8	24 3/16	1 1/4	WILLYS		VT	C	2	16	GR	2 3/4	24 5/8	3/8		A	N	124683
									GR	2 1/4	24	3/8		A		

Vista-Pro Automotive - Core Catalog

(Cores Sorted by Application)

Height	Width	Depth	Application	Description	Fin Type	Fin Matl	Rows	FPI	BH/TH Type	BH/TH Width	BH/TH Length	BH/TH OHF	BH/TH Bolts	BH/TH Shape	Hdr Support	Part #
WILLYS (Cont)																
15 5/8	24 3/16	2	WILLYS		VT	C	3	12	GR	2 3/4	24 5/8	C		A	N	124702
									GR	2 1/4	24	C		A		
15 3/4	17 1/16	1 1/4	WILLYS		VT	C	2	12	GR	2 3/4	16 5/8	5/8		A	N	124699
									GR	2 3/4	16 5/8	5/16		A		
15 7/8	25 7/8	2	WILLYS		VT	C	3	12	GR	3	25 9/16	C		A	N	122277
									GR	2 3/4	25 9/16	C		A		
15 7/8	25 7/8	2	WILLYS		VT	C	3	14	GR	3	25 9/16	C		A	N	124519
									GR	3	25 9/16	C		A		
16	25 7/8	1 1/4	WILLYS		VT	C	2	16	GR	3	25 9/16	3/16		A	N	124748
									GR	2	25 9/16	3/16		A		
16	25 7/8	2	WILLYS		VT	C	3	12	GR	3	25 9/16	C		A	N	124747
									GR	2 3/4	25 9/16	C		A		
16 3/8	24 3/16	1 1/4	WILLYS		VT	C	2	12	GR	2 13/16	24 5/8	1/2		A	N	124701
									GR	2 1/4	24	1/2		A		
16 3/8	24 3/16	2	WILLYS		VT	C	3	12	GR	2 13/16	24 5/8	C		A	N	124700
									GR	2 1/4	24	C		A		
16 1/2	24 3/16	2	WILLYS		VT	C	3	12	GR	2 13/16	24 5/8	C		A	N	122546
									GR	2 1/4	24 3/4	C		A		
16 7/8	22	1 1/4	WILLYS		VT	C	2	12	GR	2 1/4	21 3/4	3/16		A	N	124517
									GR	2 1/4	21 3/4	3/16		A		
16 7/8	22	2	WILLYS		VT	C	3	12	GR	2 1/4	21 3/4	C		A	N	128402
									GR	2 1/4	21 3/4	C		A		
WITTE																
15 7/8	16 1/4	2 1/4	WITTE	R72, 98 CONDENSER HVY BTM HDR W/TANK & SIDES	X	C	3	7	SQ	2 3/4	16 3/8	C		A	C	221853
									BH	4 9/16	20	C	18	A		
18	16 1/4	2 1/4	WITTE	F42, F28 HVY BTM HDR W/TANK & SIDES	X	C	3	8	SQ	2 3/4	16 3/8	C		A	C	273468
									BH	4 13/16	20	C	18	A		
WORTHINGTON																
21 3/8	19 13/16	2	WORTHINGTON		VT	C	3	12	GR	3 1/8	19 5/8	1/4		A	N	124667
									GR	2 5/16	19 5/8	C		A		
23	23 5/8	1 1/4	WORTHINGTON		VT	C	2	12	GR	3	24	1/4		A	N	124669
									GR	3	24	1/4		A		



Core Listings

- By size



Vista-Pro Automotive - Core Catalog
(Cores Sorted by Size)

Height	Width	Depth	Application	Description	Fin Type	Fin Matl	Rows	FPI	BH / TH Type	BH / TH Width	BH / TH Length	BH / TH OHF	BH / TH Bolts	BH / TH Shape	Hdr Support	Model #
8 3/4	8 13/16	2	HONDA		VT	C	3	12	GR GR	2 3/8 2 3/8	9 3/8 9 3/8	C C		A A	N	128495
9 5/8	15 3/8	2	TRIUMPH		VT	C	3	12	GR GR	2 1/4 2 1/4	15 7/8 15 7/8	C C		A A	N	124920
9 7/8	21 7/16	2	TRIUMPH		VT	C	3	14	GR GR	2 1/4 2 1/4	22 1/8 22 1/8	C C		A A	N	128490
10	21 3/8	1 1/2	TRIUMPH		T	C	2	10	GR GR	2 5/16 2 5/16	22 1/4 22 1/4	C C		A A	N	263207
10 1/8	21 1/4	1 7/8	MORRIS		X	C	2	9	GR GR	2 1/4 2 1/4	22 1/4 22 1/4	C C		A A	N	261669
10 5/16	18	2 1/4	MG		T	C	3	11	GR GR	2 3/4 2 3/4	18 1/2 18 1/2	C C		A A	N	261784
10 5/16	18 1/8	2	MG		VT	C	3	14	GR GR	2 3/4 2 3/4	18 5/8 18 5/8	C C		A A	N	124807
10 5/8	10 7/16	2	AUSTIN		VT	C	3	12		2 1/8 2 1/8	11 11	C C		0 0	N	128349
10 5/8	16 5/16	3	LIFT TRUCKS & LOADERS	BAKER	T	C	4	7	GR GR	3 1/4 3 1/4	16 1/2 16 1/2	C C		A A	N	279488
10 5/8	22	2	MAZDA		VT	C	3	12	GR GR	2 1/2 2 1/2	21 3/4 21 3/4	C C		A A	N	124752
10 3/4	19 1/4	1 1/4	DATSUN		VT	C	2	14	BU GR	3 2 1/8	19 1/2 19 1/2	C C		A A	N	124612
10 3/4	19 1/4	1 1/4	DATSUN		VT	C	2	12	BU GR	3 2	19 1/2 19 1/2	C C		A A	N	128791
10 3/4	19 1/4	1 1/4	NISSAN		VT	C	2	12	BU GR	3 2 1/8	19 7/16 19 5/8	C C		A A	N	124611
10 3/4	19 1/4	2	NISSAN		VT	C	3	14	BU GR	3 2 1/4	19 7/16 19 1/4	C C		A A	N	124934
10 3/4	19 1/4	2	NISSAN		VT	C	3	14	BU FR	3 2 1/8	19 7/16 19 1/4	C C		A A	N	124951
10 3/4	20 7/8	2	SUNBEAM		VT	C	3	12	GR GR	2 1/4 2 1/4	21 3/8 21 3/8	C C		A A	N	124623
11	9 7/8	2	HONDA		VT	C	3	12	GR GR	2 1/2 2 1/2	10 1/2 10 1/2	C C		A A	N	124846
11 1/8	14 7/16	1 9/16	AUSTIN		VE	C	3	14	GR GR	4 7/8 2 1/4	14 13/16 14 13/16	3/16 C		A A	N	128812
11 1/4	14 7/8	2	AUSTIN		VT	C	3	12	GR GR	5 2 1/4	14 3/4 14 3/4	C C		A A	N	128329
11 3/8	14 3/8	1 7/8	AUSTIN		X	C	2	11	GR GR	5 2 1/4	14 3/4 14 3/4	C C		A A	N	262882
11 3/8	14 7/8	2	MG		VT	C	3	12	GR FR	5 2 1/8	14 3/4 14 3/4	3/8 C		A A	N	128339
11 3/8	21 7/16	2	MAZDA		VT	C	3	12	GR GR	2 1/2 2 1/2	21 3/4 21 3/4	C C		A A	N	124792
11 1/2	18 11/16	1 1/4	FIAT		VT	C	2	12	GR GR	2 2	19 19	C C		A A	N	124799
11 1/2	19 1/8	2 1/4	LIFT TRUCKS & LOADERS	DATSUN FG-103-P3	T	C	3	9	GR GR	3 3/4 3 1/4	19 3/8 19 3/8	3/16 3/16		A A	N	279489
11 1/2	19 1/4	1 1/4	AUSTIN		VT	C	2	12	GR GR	1 7/8 1 7/8	19 5/16 19 5/16	C C		A A	N	128444
11 1/2	19 3/8	2 1/4	LIFT TRUCKS & LOADERS	DATSUN FG-103-P3	X	C	3	9	GR GR	3 3/4 3 1/4	19 3/8 19 3/8	C C		A A	N	286472
11 5/8	13 3/4	2	MG		VT	C	3	12	GR GR	5 2 1/4	14 3/4 14 3/4	C C		A A	N	128364
11 3/4	11	2	OPEL		VT	C	3	12	GR GR	2 1/2 2 1/2	11 1/2 11 1/2	C C		A A	N	124528
11 3/4	17 3/4	1	MAZDA		VE	C	2	18	GR GR	1 3/4 1 3/4	17 7/8 17 7/8	C C		A A	N	128250
11 7/8	15 1/4	1 9/16	HONDA		VE	C	3	17	GR GR	2 1/2 2 1/2	15 3/8 15 3/8	C C		A A	N	128228
11 7/8	15 3/8	1 1/4	HONDA		VT	C	2	13	GR GR	1 13/16 1 13/16	15 5/16 15 5/16	C C		A A	N	124707
11 7/8	15 3/8	2	HONDA		VT	C	3	14	GR GR	2 1/2 2 1/2	15 3/8 15 3/8	C C		A A	N	124847

Vista-Pro Automotive - Core Catalog
(Cores Sorted by Size)

Height	Width	Depth	Application	Description	Fin Type	Fin Matl	Rows	FPI	BH / TH Type	BH / TH Width	BH / TH Length	BH / TH OHF	BH / TH Bolts	BH / TH Shape	Hdr Support	Model #
12	10 5/8	2 7/8	TRUCK AND BUS HEATER	CARPENTER, THOMAS	R	C	5	11	GR	3 1/4	10 1/2	C		A	N	226712
									GR	3 1/4	10 1/2	C		A		
12	11 9/16	1 1/4	VEGA		VT	C	2	14	GR	2	13 3/16	C		A	N	124562
									GR	2	13 3/16	C		A		
12	11 9/16	2	GM		VT	C	3	12	GR	2 3/4	13 3/16	C		A	N	124608
									GR	2 1/4	13 1/4	C		A		
12	14 7/8	1 1/4	CHEVROLET	CHEVETTE	VT	C	2	12	GR	2 3/4	16 1/2	3/8		A	N	124785
									GR	2 3/4	16 1/2	3/8		A		
12	14 7/8	2	GM		VT	C	3	12	GR	2 3/4	16 1/2	C		A	N	124786
									GR	2 3/4	16 1/2	C		A		
12 1/4	23 1/8	1 1/4	GM		VT	C	2	12	GR	2 1/2	23 1/2	3/8		A	N	122299
									GR	2	23 1/2	C		A		
12 1/4	23 1/8	2	BUICK		VT	C	3	12	GR	2 1/2	23 1/2	3/8		A	N	124560
									GR	2 1/4	23 1/2	C		A		
12 1/4	25 5/16	1 1/4	BUICK		VT	C	2	12	GR	2 3/4	25 7/16	C		A	N	122354
									GR	2 3/4	25 7/16	C		A		
12 1/4	25 5/16	2	GM		VT	C	3	12	GR	2 3/4	25 7/16	C		A	N	122362
									GR	2 3/4	25 7/16	C		A		
12 1/4	25 7/8	2 5/8	FERRARI		VT	C	4	12		2 5/8	26	C		0	N	128512
										2 5/8	26	C		0		
12 1/2	18 3/4	2 1/4	ALFA-ROMEO		X	C	3	8	GR	2 5/8	18 3/4	C		A	N	265938
									GR	2 5/8	18 3/4	C		A		
12 1/2	19 1/4	2	VOLVO		VT	C	3	12	GR	4 3/8	19 3/4	C		A	N	124877
									GR	2 1/4	19 3/4	C		A		
12 1/2	19 13/16	2	VOLVO		VT	C	3	14	GR	2 1/4	19 5/8	C		A	N	124801
									GR	2 1/4	19 5/8	C		A		
12 1/2	19 13/16	2	VOLVO		VT	C	3	14		2 1/8	19 1/2	C		0	N	128275
										2 5/16	19 1/2	C		0		
12 5/8	17 1/2	1 3/4	ALFA-ROMEO		R	C	3	11	GR	2 3/4	18 1/8	C		A	N	265788
									GR	2	18 1/8	C		A		
12 5/8	18 1/8	1 1/4	ALFA ROMEO		VT	C	2	16	GR	2 3/4	18 1/8	C		A	N	128413
									GR	1 15/16	18 1/8	C		A		
12 5/8	18 1/8	2	ALFA ROMEO		VT	C	3	12	GR	2 3/4	18 1/8	C		A	N	128118
									FR	2 1/8	18 1/8	C		A		
12 5/8	18 11/16	2	GM		VT	C	3	12	GR	2 1/4	18 1/2	C		A	N	122417
									GR	2 1/4	18 1/2	C		A		
12 5/8	23 5/8	2	MAZDA		VT	C	3	12	GR	2 3/8	24	C		A	N	124754
									GR	2 3/8	24	C		A		
12 3/4	12 3/8	3	MG		T	C	4	11	GR	3 1/4	12 3/4	C		A	N	264346
									GR	3 1/4	12 3/4	C		A		
12 3/4	12 5/8	2 5/8	TRIUMPH		VT	C	4	12		3 1/4	12 3/4	C		0	N	128376
										3 1/4	12 3/4	C		0		
12 3/4	14 7/8	2	OPEL		VT	C	3	12	GR	2 1/2	15	C		A	N	124527
									GR	2 1/2	15	C		A		
12 3/4	16 1/2	1 1/4	PLYMOUTH		VT	C	2	12	GR	1 13/16	16 7/8	C		A	N	124946
									GR	1 13/16	16 7/8	C		A		
12 3/4	16 1/2	2	TOYOTA		VT	C	3	12	GR	2 1/4	16 3/4	C		A	N	128165
									GR	2 1/4	16 3/4	C		A		
12 3/4	16 1/2	2	HYUNDAI		VT	C	3	14	GR	2 1/2	16 13/16	C		A	N	128587
									GR	2 1/2	16 13/16	C		A		
12 3/4	18 1/8	1 1/4	MAZDA		VT	C	2	12	GR	1 7/8	18 1/4	C		A	N	128672
									GR	1 7/8	18 1/4	C		A		
12 3/4	19 1/4	1 1/4	TOYOTA		VT	C	2	12	BU	2 13/16	19 7/16	C		A	N	124625
									GR	1 7/8	19 5/8	C		A		
12 3/4	19 1/4	1 1/4	TOYOTA		VT	C	2	12	GR	1 7/8	19 5/8	C		A	N	124725
									GR	1 7/8	19 5/8	C		A		
12 3/4	19 3/8	2 3/16	LIFT TRUCKS & LOADERS	TOYOTA LIFT	Z	C	3	7	GR	3	19 7/8	C		A	N	286623
									GR	2 3/4	19 7/8	C		A		
12 3/4	19 11/16	2 1/4	LIFT TRUCKS & LOADERS	YALE 31140644	T	C	3	9	GR	3	19 7/8	C		A	N	265521
									GR	2 3/4	19 7/8	C		A		
12 3/4	19 11/16	2 1/4	LIFT TRUCKS & LOADERS	TOYOTA LIFT	T	C	3	7	GR	3	19 7/8	C		A	N	279493
									GR	2 3/4	19 7/8	C		A		
12 7/8	20 7/8	1 1/4	HONDA		VT	C	2	14	GR	1 3/4	21	C		A	N	124849
									GR	1 3/4	21	C		A		

Vista-Pro Automotive - Core Catalog
(Cores Sorted by Size)

Height	Width	Depth	Application	Description	Fin Type	Fin Matl	Rows	FPI	BH / TH Type	BH / TH Width	BH / TH Length	BH / TH OHF	BH / TH Bolts	BH / TH Shape	Hdr Support	Model #
12 7/8	25 5/16	2 5/8	VT CORE		VT	C	4	10	GR GR	3 3	25 5/16 25 5/16	C C		A A	N	129030
13	11 9/16	2	FIAT		VT	C	3	16		3 2 5/8	12 12	C C		0 0	N	128414
13	13 3/4	1 1/4	DATSUN		VT	C	2	12	GR GR	2 1/4 1 7/8	13 1/2 13 1/2	C C		A A	N	124613
13	13 3/4	1 1/4	DATSUN		VT	C	2	12	GR GR	2 1/2 1 7/8	13 1/2 13 1/2	C C		A A	N	124730
13	15	4 7/16	LIFT TRUCKS & LOADERS	HYSTER BRASS FINS	Z	B	6	9	GR GR	6 6	15 3/4 15 3/4	C C		A A	N	281541
13	15	5 3/16	LIFT TRUCKS & LOADERS	HYSTER BRASS FINS	Z	B	7	6	GR GR	6 6	15 7/8 15 7/8	C C		A A	N	225473
13	15	5 1/4	LIFT TRUCKS & LOADERS	HYSTER	X	C	7	8	GR GR	6 6	15 7/8 15 7/8	C C		A A	N	221498
13	16 1/2	1 1/4	DATSUN		VT	C	2	12	GR GR	2 1/2 2	16 1/4 16 1/4	C C		A A	N	128141
13	17 5/8	1 1/4	NISSAN		VT	C	2	12	GR GR	2 1/2 2	18 18	C 3/16 C		A A	N	124680
13	18 1/8	1 1/4	NISSAN		VT	C	2	15	GR GR	2 1/2 2	18 18	C C		A A	N	124843
13	18 11/16	1 1/4	DATSUN		VT	C	2	12	GR GR	2 7/16 2 1/16	19 19	C C		A A	N	124749
13	18 11/16	1 1/4	NISSAN		VT	C	2	14	GR GR	1 7/8 1 7/8	18 7/8 18 7/8	C C		A A	N	122291
13	18 11/16	2	DATSUN		VT	C	3	12	GR GR	2 7/16 2 7/16	19 19	C C		A A	N	124794
13	21 7/16	2	DATSUN		VT	C	3	14	GR GR	2 5/8 2 1/2	21 3/4 21 3/4	C C		A A	N	124827
13 1/8	15 5/8	5 3/16	LIFT TRUCKS & LOADERS	HYSTER BRASS FINS	Z	B	7	6	GR GR	6 6	15 7/8 15 7/8	C C		A A	N	225570
13 1/8	19 3/8	2 1/4	LIFT TRUCKS & LOADERS	DATSUN LIFT	X	C	3	8	GR GR	3 1/4 3 1/4	19 1/4 19 1/4	C C		A A	N	282733
13 1/8	25 5/16	2	NISSAN		VT	C	3	14	GR GR	2 1/2 2 1/2	25 5/8 25 5/8	C C		A A	N	128152
13 1/4	13 1/2	2 1/4	AVERY		T	C	3	9	CR CR	4 7/8 2 1/4	13 1/2 13 1/2	C C		A A	N	223044
13 1/4	15 3/16	2 1/4	FIAT ALLIS		T	C	3	7	GR GR	3 1/8 2 1/2	15 1/2 15 1/2	C 1/4 1/4		A A	N	260118
13 1/4	15 1/4	1	BMW		VE	C	2	14	GR GR	1 7/8 1 5/8	15 7/8 15 7/8	C C		A A	N	128221
13 1/4	15 3/8	1 1/4	BMW		VT	C	2	16	GR GR	1 7/8 1 5/8	15 7/8 15 7/8	C C		0 A	N	124811
13 1/4	15 3/8	2	BMW		VT	C	3	14	GR GR	2 1/16 2 1/16	15 3/4 15 3/4	C C		A A	N	128432
13 1/4	15 3/4	1 1/2	BMW		T	C	2	10		1 7/8 1 5/8	15 7/8 15 7/8	C C		0 0	N	265035
13 1/4	17 5/8	1 1/4	BMW		VT	C	2	12		1 7/8 1 5/8	18 18	C C		0 0	N	124908
13 1/4	20	1 7/8	JEEP		X	C	2	8	GR GR	3 3/4 2 3/8	20 20	FF C		A A	N	263563
13 1/4	20	1 7/8	JEEP		X	C	2	10	GR FR	3 3/4 2	20 20	FF C		A A	N	264052
13 1/4	20	3	JEEP		X	C	4	9	GR GR	3 3/4 3	20 20	FF C		A A	N	262751
13 1/4	20 1/4	3	JEEP		T	C	4	8	GR GR	4 3	20 1/4 20 1/4	C C		A A	N	261386
13 3/8	9 3/8	1 3/4	TRUCK AND BUS HEATER	BLUEBIRD 0557637	R	C	3	7	GR GR	2 1/2 2 1/2	9 9	C 1/4 1/4		A A	N	226715
13 3/8	15 11/16	1	BMW		VE	C	2	16	GR GR	1 7/8 1 5/8	15 7/8 15 7/8	C C		A A	N	128809
13 3/8	15 11/16	1 9/16	BMW		VE	C	3	16	GR SQ	1 7/8 1 5/8	15 7/8 15 7/8	C C		A A	N	122701
13 3/8	15 11/16	1 9/16	BMW		VE	C	3	14	GR GR	1 7/8 1 7/8	15 7/8 15 7/8	C C		A A	N	122702

Vista-Pro Automotive - Core Catalog
(Cores Sorted by Size)

Height	Width	Depth	Application	Description	Fin Type	Fin Matl	Rows	FPI	BH / TH Type	BH / TH Width	BH / TH Length	BH / TH OHF	BH / TH Bolts	BH / TH Shape	Hdr Support	Model #
13 3/8	15 15/16	1 1/4	BMW		VT	C	2	16	GR GR	1 7/8 1 7/8	15 7/8 15 7/8	C C		A A	N	124797
13 3/8	17 3/4	1 9/16	BMW		VE	C	3	16	SQ SQ	1 7/8 1 7/8	18 1/2 18 1/2	C C		A A	N	122339
13 1/2	14 3/8	2 15/16	LIFT TRUCKS & LOADERS	HYSTER 520A	Z	C	4	8	GR GR	3 1/2 3 1/2	15 3/4 15 3/4	C C		A A	N	288495
13 1/2	15 3/16	3	LIFT TRUCKS & LOADERS	HYSTER	T	C	4	8	GR GR	3 1/2 3 1/2	15 3/4 15 3/4	1/4 1/4		A A	N	223218
13 1/2	17 1/16	1 1/4	CHEVROLET	LUV	VT	C	2	12	GR GR	2 7/8 2	16 7/8 16 7/8	C C		A A	N	124679
13 1/2	17 1/16	2	GM		VT	C	3	12	GR GR	2 5/8 2 1/8	16 7/8 16 3/4	C C		A A	N	128475
13 1/2	19 13/16	1 1/4	OPEL		VT	C	2	12	GR GR	2 2	19 13/16 19 13/16	C C		A A	N	124913
13 1/2	19 13/16	1 1/4	JEEP		VT	C	2	12	GR GR	3 1/8 2 3/8	20 20	C C		A A	N	122353
13 1/2	19 13/16	1 1/4	NISSAN		VT	C	2	12	GR GR	2 2	19 5/8 19 5/8	C C		A A	N	128453
13 5/8	20 7/8	1 1/4	GM		VT	C	2	16	GR GR	1 7/8 1 7/8	21 21	C C		A A	N	128278
13 5/8	22 9/16	2	MERCEDES-BENZ		VT	C	3	12	GR GR	2 1/4 2 1/4	22 3/8 22 3/8	C C		A A	N	128330
13 3/4	11 13/16	2 1/4	INT'L HARVESTER	FARMALL CUB 352903 R92	T	C	3	7	GR BL	3 1/4 4	12 14 1/4	C C	18	A A	N	223173
13 3/4	11 7/8	2 3/16	INT'L HARVESTER	FARMALL CUB	Z	C	3	9	GR BL	3 1/4 4	12 14 1/4	9/16 9/16	18	A A	N	225444
13 3/4	11 7/8	2 3/8	INT'L HARVESTER	FARMALL CUB 351878-R93	S	C	4	8	GR BL	3 1/4 4	12 14 1/4	C C	18	A A	N	229088
13 3/4	15 3/8	1 1/4	SUZUKI		VT	C	2	12	GR GR	1 7/8 1 7/8	15 5/8 15 5/8	C C		A A	N	128737
13 3/4	17 1/2	2 7/8	LIFT TRUCKS & LOADERS	HYSTER H25E	S	C	5	7	GR GR	3 1/2 3 1/2	17 3/4 17 3/4	C C		A A	N	266132
13 3/4	18 9/16	3	AUSTIN		T	C	4	8		4 3/4 3 1/4	19 1/4 19 1/4	C C		0 0	N	264123
13 3/4	19 1/4	1 1/4	HONDA		VT	C	2	12	GR GR	2 1/2 2	19 1/4 19 1/4	C C		A A	N	124834
13 3/4	19 3/8	2 1/4	LIFT TRUCKS & LOADERS	TOYOTA LIFT	X	C	3	9	GR GR	2 7/8 2 5/8	19 3/4 19 3/4	3/16 3/16		A A	N	286376
13 3/4	19 13/16	2	AMC		VT	C	3	12	BX BX	2 2	19 5/8 19 5/8	C C		A A	N	122273
13 3/4	22 9/16	1 1/4	MAZDA		VT	C	2	12	GR GR	1 3/4 1 3/4	22 5/8 22 5/8	C C		A A	N	128766
13 3/4	23 5/8	1 1/4	DATSUN		VT	C	2	14	GR GR	3 2 1/4	24 24	C		A A	N	124604
13 3/4	23 5/8	1 1/4	MITSUBISHI		VT	C	2	14	GR GR	1 3/4 1 3/4	23 7/8 23 7/8	C C		A A	N	128566
13 3/4	23 5/8	2	DATSUN		VT	C	3	12	GR GR	3 3	24 24	C C		A A	N	124706
13 3/4	23 5/8	2	DATSUN		VT	C	3	12	GR GR	3 2 1/2	24 24	C C		A A	N	124941
13 7/8	13 1/2	2 1/4	MASSEY-FERGUSON		T	C	3	6	GR GR	4 1/4 4 1/4	14 3/8 14 3/8	1/4 1/4		A A	N	261592
13 7/8	13 3/4	2 3/16	MASSEY-FERGUSON	MODEL 11	Z	C	3	7	SQ SQ	4 1/8 4 1/8	14 1/4 14 1/4	1/16 1/16		A A	N	287243
13 7/8	13 3/4	2 1/4	CLIMAX	C-46 CONDENSER HVY BTM HDR W/TANK & SIDES	X	C	3	7	SQ BH	2 3/4 4 1/2	13 7/8 15 3/4	C C	21	A A	C	221835
13 7/8	15	2 1/4	LIFT TRUCKS & LOADERS	TCM FORK LIFT	X	C	3	8	GR GR	2 3/4 2 3/4	15 3/4 15 3/4	1/2 1/2		A A	N	282787
13 7/8	15 3/8	2	TCM FORK LIFT		VT	C	3	12	GR GR	2 3/4 2 3/4	15 3/4 15 3/4	1/2 1/2		A A	N	122669
13 7/8	17 1/2	2 15/16	LIFT TRUCKS & LOADERS	HYSTER	Z	C	4	11	GR GR	3 1/4 3 1/4	18 3/8 18 3/8	C C		A A	N	225474
13 7/8	17 1/2	3	LIFT TRUCKS & LOADERS	TOWMOTOR	X	C	4	6	SQ SQ	4 4	18 18	3/16 3/16		A A	N	286781

Vista-Pro Automotive - Core Catalog
(Cores Sorted by Size)

Height	Width	Depth	Application	Description	Fin Type	Fin Matl	Rows	FPI	BH / TH Type	BH / TH Width	BH / TH Length	BH / TH OHF	BH / TH Bolts	BH / TH Shape	Hdr Support	Model #
13 7/8	17 5/8	2	OPEL		VT	C	3	12	GR	2 1/2 2 1/2	17 3/4 17 3/4	C		A	N	124863
13 7/8	18 11/16	1 1/4	FIAT		VT	C	2	16	GR	1 7/8 1 7/8	18 15/16 18 15/16	C		A	N	128203
13 7/8	20 1/4	1 9/16	FIAT		VE	C	3	16	GR	1 15/16 1 15/16	20 9/16 20 9/16	C		A	N	124968
14	13 1/2	2 1/4	KOHLER ENGINES & GEN	LIGHT GENERATOR L- 654	T	C	3	11	GR	4 1/8 4 1/8	14 1/4 14 1/4	1/4 1/4		A	N	265652
14	13 3/4	2 3/8	KOHLER ENGINES & GEN	9 KW A-241346	S	C	4	11	GR	4 1/8 4 1/8	14 1/4 14 1/4	1/8 1/8		A	N	229120
14	14 5/8	2 1/4	FIAT ALLIS	D-12	T	C	3	8	GR	4 3/8 2 1/2	15 15	1/4 C		A	N	223597
14	17 5/8	2	FORD		VT	C	3	12	GR	4 2 1/16	17 3/4 17 3/4	1 7/8 C		A	N	128440
14	17 5/8	2 5/8	LIFT TRUCKS & LOADERS		VT	C	4	16	GR	3 1/4 3 1/4	18 1/2 18 1/2	C C		A	N	128735
14	18 1/8	2	MG		VT	C	3	12	GR	2 3/4 2 3/4	18 7/16 18 7/16	C C		A	N	124915
14	18 11/16	2	FIAT		VT	C	3	12		2 2	19 19	C C		0 0	N	122312
14	24 3/8	2 15/16	TIMBER JACK		Z	C	4	10	GR	3 1/2 3 1/2	25 3/4 25 3/4	C C		A	N	286631
14	25	4 7/16	TREE FARMER	BRASS FINS	Z	B	6	9	GR	4 3/4 4 3/4	25 3/4 25 3/4	C C		A	N	289210
14	25	4 1/2	TREE FARMER		B	C	6	7	GR	4 3/4 4 3/4	25 3/4 25 3/4	C C		A	N	279947
14 1/16	19 13/16	2	MG		VT	C	3	12	GR	2 1/2 2 1/2	20 20	C C		A	N	128383
14 1/8	18 11/16	1 1/4	CHEVROLET		VT	C	2	12	GR	2 1/4 2 1/4	18 1/2 18 1/2	C C		A	N	122382
14 1/8	18 11/16	2	CHEVROLET		VT	C	3	12	GR	2 1/4 2 1/4	18 1/2 18 1/2	C C		A	N	122331
14 1/8	21 7/16	2	NISSAN		VT	C	3	12	GR	2 5/8 2 1/16	21 3/4 21 3/4	C C		A	N	128442
14 1/8	24 3/16	2	DATSUN		VT	C	3	14	GR	2 7/16 2 7/16	24 1/2 24 1/2	C C		A	N	124912
14 1/8	25 5/16	1 1/4	NISSAN		VT	C	2	12	GR	1 13/16 1 13/16	25 3/4 25 3/4	C C		A	N	128759
14 1/4	10 7/16	1 1/4	MG		VT	C	2	15		2 2	11 11	C C		0 0	N	124810
14 1/4	14 5/16	2	NISSAN		VT	C	3	12	GR	3 1/8 2 1/4	15 3/8 14 7/8	C C		A	N	128671
14 1/4	15 3/8	2	NISSAN		VT	C	3	12	GR	3 2 1/4	15 1/4 15 1/4	FF C		A	N	124614
14 1/4	18 11/16	1 1/4	JEEP		VT	C	2	12	BU	4 1 3/4	19 1/4 18 1/2	C C		A	N	122544
14 1/4	19 1/2	3	TOYOTA LIFT TRUCK		B	C	4	9	GR	3 1/4 3 1/4	19 7/8 19 7/8	C C		A	N	225688
14 1/4	19 13/16	2	TOYOTA LIFT TRUCK		VT	C	3	12	GR	2 3/4 2 3/4	19 7/8 19 7/8	C C		A	N	122668
14 1/4	21 7/16	1 1/4	DATSUN		VT	C	2	13	GR	2 3/4 2 1/16	21 3/4 21 3/4	C C		A	N	124728
14 5/16	25 5/16	1 1/4	GM		VT	C	2	12	GR	2 3/4 2 3/4	25 7/16 25 7/16	3/8 3/8		A	N	122444
14 5/16	25 5/16	2	GM		VT	C	3	12	GR	2 3/4 2 3/4	25 7/16 25 7/16	C C		A	N	122446
14 5/16	25 5/16	2 5/8	GM		VT	C	4	12	GR	3 3/8 3 3/8	25 7/16 25 7/16	C C		A	N	122448
14 3/8	19 1/4	2 5/8	TOYOTA LIFT TRUCK		VT	C	4	12	GR	3 3	19 5/8 19 5/8	C C		A	N	122666
14 3/8	24 3/16	1 1/4	NISSAN		VT	C	2	12	GR	2 5/8 2 7/16	24 1/2 24 1/2	C C		0 A	N	124950
14 1/2	10 11/16	1 1/2	AUSTIN		T	C	2	11		2 2	11 11	C C		0 0	N	264326

Vista-Pro Automotive - Core Catalog
(Cores Sorted by Size)

Height	Width	Depth	Application	Description	Fin Type	Fin Matl	Rows	FPI	BH / TH Type	BH / TH Width	BH / TH Length	BH / TH OHF	BH / TH Bolts	BH / TH Shape	Hdr Support	Model #
14 1/2	14 3/8	2 3/16	FIAT ALLIS		Z	C	3	9	GR	4 3/8	15	3/16		A	N	281708
									GR	2 1/2	15	3/16		A		
14 1/2	14 5/8	2 1/4	FIAT ALLIS		T	C	3	7	GR	4 3/8	15	1/4		A	N	223120
									GR	2 1/2	15	1/4		A		
14 1/2	15	2 1/4	FIAT ALLIS		X	C	3	7	GR	4 3/8	15	1/8		A	N	221806
									GR	2 1/2	15	1/8		A		
14 1/2	15 3/16	2 1/4	AVERY		T	C	3	8	GR	6	15 3/4	1/4		A	N	223045
									GR	2 1/2	15 3/4	1/4		A		
14 1/2	15 3/16	2 1/4	MONTGOMERY WARD	TRACTOR	T	C	3	7	GR	6	15 5/8	1/8		A	N	271007
									GR	2 1/2	15 5/8	1/8		A		
14 1/2	15 5/8	2 3/16	MONTGOMERY WARD	TRACTOR	Z	C	3	10	GR	6	15 5/8	3/16		A	N	280173
									GR	2 1/2	15 5/8	3/16		A		
14 1/2	15 3/4	2 1/4	HERCULES ENGINE		T	C	3	6	GR	6	15 5/8	1/4		A	N	261007
									GR	2 1/2	15 5/8	1/4		A		
14 1/2	15 3/4	2 1/4	JEEP		T	C	3	10	GR	2 1/2	15 7/8	C		A	N	261204
									GR	2 1/2	15 7/8	C		A		
14 1/2	18 11/16	1 1/4	AMC		VT	C	2	14	GR	3 1/4	19	C		A	N	122323
									GR	2 1/4	19	C		A		
14 1/2	19 1/8	2 1/4	LIFT TRUCKS & LOADERS	DATSUN FORKLIFT	T	C	3	8	GR	3 1/8	19 3/8	C		A	N	279505
									GR	3 1/8	19 3/8	C		A		
14 1/2	19 3/8	2 1/4	LIFT TRUCKS & LOADERS	DATSUN	X	C	3	8	GR	3 1/4	19 3/8	C		A	N	221791
									GR	3 1/4	19 3/8	C		A		
14 1/2	19 3/8	2 1/4	LIFT TRUCKS & LOADERS	TOYOTA LIFT	X	C	3	9	GR	3	19 3/4	3/16		A	N	289327
									GR	2 5/8	19 3/4	3/16		A		
14 1/2	19 3/8	2 1/4	LIFT TRUCKS & LOADERS	TOYOTA LIFT	X	C	3	11	GR	3	20	3/16		A	N	289933
									GR	3	20	3/16		A		
14 1/2	19 11/16	2 1/4	LIFT TRUCKS & LOADERS	TOYOTA LIFT	T	C	3	9	GR	3	19 7/8	3/16		A	N	223258
									GR	2 5/8	19 7/8	C		A		
14 1/2	21 7/16	2	TRIUMPH		VT	C	3	12	GR	2 3/4	21 3/4	C		A	N	124588
									GR	2 3/4	21 3/4	C		A		
14 5/8	19 1/8	2 1/4	LIFT TRUCKS & LOADERS	DATSUN FG-105 P5	T	C	3	9	GR	3 3/4	19 3/8	C		A	N	279508
									GR	3 1/4	19 3/8	C		A		
14 5/8	19 1/8	3	LIFT TRUCKS & LOADERS	DATSUN FORKLIFT	T	C	4	7	GR	3 3/8	19 1/2	C		A	N	223216
									GR	3 3/8	19 1/2	C		A		
14 5/8	19 3/8	2 1/4	LIFT TRUCKS & LOADERS	DATSUN FG-105-P5	X	C	3	9	GR	3 3/4	19 3/8	C		A	N	286471
									GR	3 1/4	19 3/8	C		A		
14 5/8	23 5/8	1 1/4	MITSUBISHI		VT	C	2	14	GR	1 3/4	23 13/16	C		A	N	128943
									GR	1 3/4	23 13/16	C		A		
14 5/8	24 3/16	1 1/4	RAMBLER		VT	C	2	12	GR	2 13/16	24 5/8	5/8		A	N	122447
									GR	1 3/4	24 5/8	C		A		
14 5/8	24 3/16	1 1/4	RAMBLER		VT	C	2	12	GR	2 13/16	24 5/8	FR		A	N	122531
									GR	1 3/4	24	C		A		
14 5/8	24 3/16	1 1/4	AMC		VT	C	2	12	GR	2 13/16	24 5/8	FR		A	N	122283
									GR	1 3/4	24 5/8	FR		A		
14 5/8	24 3/16	1 1/4	AMC		VT	C	2	12	GR	2 13/16	24 5/8	C		A	N	122504
									GR	2	24 5/8	C		A		
14 5/8	24 3/16	1 1/4	AMC		VT	C	2	12	GR	2 13/16	24 5/8	C		A	N	124531
									GR	1 5/8	24 5/8	C		A		
14 5/8	24 3/16	1 1/4	AMC		VT	C	2	12	GR	2 13/16	24 5/8	5/8		A	N	124532
									GR	1 5/8	24 5/8	C		A		
14 5/8	24 3/16	1 1/4	FORD		VT	C	2	12	GR	2 13/16	24 5/8	5/8		A	N	124551
									GR	1 3/4	24	C		A		
14 5/8	24 3/16	2	AMC		VT	C	3	12	GR	2 13/16	24 5/8	FR		A	N	122325
									GR	2 1/4	24 5/8	C		A		
14 3/4	13 3/4	2 1/4	FORD TRACTOR	ENGLISH DIESEL BTM HDR OFFSET	X	C	3	8	SQ	2 1/2	14 1/4	C		A	N	287947
									SQ	2 1/2	16 1/4	C		A		
14 3/4	14 1/16	2 1/4	FORD TRACTOR	ENGLISH DIESEL BTM HDR OFFSET	T	C	3	9	GR	2 1/2	14 1/4	C		A	N	262820
									GR	2 1/2	16 1/4	C		A		
14 3/4	14 1/16	2 1/4	FORD TRACTOR	DEXTER DIESEL BTM HDR OFFSET	T	C	3	8	GR	2 1/2	14 1/4	C		A	N	276804
									GR	2 1/2	16 1/4	C		A		
14 3/4	15 3/4	3	MASSEY-FERGUSON		T	C	4	9	GR	5 1/8	15 3/4	C		A	N	279812
									GR	3 7/8	15 3/4	C		A		
14 3/4	16 1/4	3	TORO	LAWN MOWER	X	C	4	8	GR	3 1/4	16 1/2	C		A	N	286416
									GR	3 1/4	16 1/2	C		A		

Vista-Pro Automotive - Core Catalog
(Cores Sorted by Size)

Height	Width	Depth	Application	Description	Fin Type	Fin Matl	Rows	FPI	BH / TH Type	BH / TH Width	BH / TH Length	BH / TH OHF	BH / TH Bolts	BH / TH Shape	Hdr Support	Model #
14 3/4	16 1/4	3 3/4	LIFT TRUCKS & LOADERS	CATERPILLAR LIFT	X	C	5	9	GR GR	4 3/8 4 3/8	16 1/2 16 1/2	C C		A A	N	282707
14 3/4	17 5/8	1 1/4	TOYOTA		VT	C	2	12	GR GR	2 7/8 1 7/8	17 5/8 17 11/16	C C		A A	N	124606
14 3/4	18 1/8	1 1/4	TOYOTA		VT	C	2	12	GR GR	2 1/2 1 3/4	18 18 1/4	3/16 7/16		A A	N	122305
14 3/4	19 1/8	2 1/4	LIFT TRUCKS & LOADERS	DATSUN	T	C	3	9	GR GR	3 1/4 3 1/4	19 3/8 19 3/8	C C		A A	N	223217
14 3/4	19 1/8	3	LIFT TRUCKS & LOADERS	DATSUN	T	C	4	9	GR GR	3 1/2 3 1/2	19 7/8 19 7/8	1/8 1/8		A A	N	279511
14 3/4	19 1/4	1 1/4	HONDA		VT	C	2	14	GR GR	1 3/4 1 3/4	19 5/8 19 5/8	C C		A A	N	124967
14 3/4	19 1/4	2	TOYOTA		VT	C	3	12	GR GR	2 1/2 2 1/2	19 1/2 19 1/2	C C		A A	N	124729
14 3/4	19 3/8	2 15/16	LIFT TRUCKS & LOADERS	DATSUN	Z	C	4	10	GR GR	3 1/2 3 1/2	19 7/8 19 7/8	3/16 3/16		A A	N	286549
14 3/4	19 3/8	3	LIFT TRUCKS & LOADERS	CLARK CY40B, CY50	X	C	4	9	GR GR	3 3	19 5/8 19 5/8	C C		0 0	N	266083
14 3/4	20 5/8	1 9/16	TOYOTA		VE	C	3	14	GR GR	1 7/8 1 7/8	21 21	C C		A A	N	128101
14 3/4	20 7/8	1 1/4	TOYOTA		VT	C	2	14	GR GR	1 3/4 1 3/4	20 7/8 20 7/8	C C		A A	N	124773
14 3/4	20 7/8	1 1/4	TOYOTA		VT	C	2	12	GR GR	2 2	21 21	C C		A A	N	128785
14 3/4	20 7/8	2	TOYOTA		VT	C	3	12	GR GR	2 1/2 2 1/2	21 21	C C		A A	N	124774
14 3/4	22 9/16	1 1/4	MAZDA		VT	C	2	12	GR GR	1 13/16 1 13/16	22 7/16 22 7/16	C C		A A	N	128563
14 3/4	25 5/16	1 1/4	TOYOTA		VT	C	2	13	GR GR	1 7/8 1 7/8	25 3/4 25 3/4	C C		A A	N	128125
14 7/8	16 7/8	1 7/8	KUBOTA TRACTOR		X	C	2	11	GR GR	2 2	17 17	C C		A A	N	282714
14 7/8	18 3/4	2 7/8	LIFT TRUCKS & LOADERS	CLARK ANGLED CRNRS	S	C	5	7	SH SH	3 1/16 3 1/16	19 5/8 19 5/8	C C		SP SP	N	273812
14 7/8	19 3/8	2 7/8	LIFT TRUCKS & LOADERS	HYSTER	S	C	5	10		3 3	19 3/4 19 3/4	C C		0 0	N	266004
14 7/8	19 3/8	2 15/16	LIFT TRUCKS & LOADERS	CLARK CF-Y50, CFY40B ANGLED CRNRS	Z	C	4	8	SH SH	3 1/8 3 1/8	19 3/4 19 3/4	C C		SP SP	N	288418
14 7/8	20	2 1/4	LIFT TRUCKS & LOADERS	CLARK CF-Y50,CFY40B	X	C	3	9	GR GR	3 1/8 3 1/8	19 3/4 19 3/4	C C		A A	N	265458
14 7/8	24 3/16	2	STUDEBAKER		VT	C	3	12	GR GR	2 13/16 2 13/16	24 5/8 24 5/8	C C		A A	N	122209
15	13 1/2	2 1/4	INT'L HARVESTER	CUB CADET JTL SERIES	T	C	3	6	GR GR	3 1/4 3 1/4	14 3/8 14 3/8	C C		A A	N	223175
15	13 3/4	2 3/16	INT'L HARVESTER	CUB CADET LAWNMOWER	Z	C	3	7	GR GR	3 1/4 3 1/4	14 3/8 14 3/8	C C		A A	N	225436
15	13 3/4	2 3/8	INT'L HARVESTER	CUB CADET JTL SERIES 404547-R3	S	C	4	7	GR GR	3 1/4 3 1/4	14 3/8 14 3/8	C C		A A	N	229089
15	15	2 3/16	JOHN DEERE		Z	C	3	7	GR GR	6 2 3/8	15 5/8 15 5/8	3/16 3/16		A A	N	281858
15	15 3/16	2 1/4	JOHN DEERE		T	C	3	7	GR GR	6 2 3/8	15 5/8 15 5/8	1/8 1/8		A A	N	223604
15	16 1/4	3	INT'L HARVESTER	444 BKT T/HDR RD INL 4 1/2" RT	X	C	4	8	BU GR	5 7/8 3 3/8	17 16 5/8	7/16 7/16		A A	N	289375
15	16 5/16	3	INT'L HARVESTER	BKT T/HDR RD INL 4 1/2" RT	T	C	4	7	BU GR	5 7/8 3 5/16	17 16 1/2	1/4 C		A A	N	276742
15	16 5/16	3	LIFT TRUCKS & LOADERS	CLARK	T	C	4	9	GR GR	3 3/8 3 3/8	17 13/16 17 13/16	C C		A A	N	261521
15	16 7/8	1 7/8	LIFT TRUCKS & LOADERS	CLARK G82	X	C	2	8	GR GR	2 3/8 2 3/8	17 1/2 17 1/2	C C		A A	N	289889
15	16 7/8	3	LIFT TRUCKS & LOADERS	HYSTER LIFT MODEL 40	X	C	4	9	GR GR	3 1/2 3 1/2	17 3/4 17 3/4	C C		A A	N	221852
15	16 7/8	3	LIFT TRUCKS & LOADERS	HYSTER	T	C	4	10	GR GR	3 1/2 3 1/2	17 3/4 17 3/4	C C		A A	N	261523

Vista-Pro Automotive - Core Catalog
(Cores Sorted by Size)

Height	Width	Depth	Application	Description	Fin Type	Fin Matl	Rows	FPI	BH / TH Type	BH / TH Width	BH / TH Length	BH / TH OHF	BH / TH Bolts	BH / TH Shape	Hdr Support	Model #
15	18 1/8	2 15/16	CASE/INTERNATIONAL		Z	C	4	7	GR GR	4 4	18 3/4 18 3/4	1 1		A A	N	225313
15	18 9/16	3	CASE/INTERNATIONAL	300, 350, 430	T	C	4	7	GR GR	4 4	18 3/4 18 3/4	1/8 1/8		A A	N	223067
15	19 1/8	2 1/4	LIFT TRUCKS & LOADERS	HYSTER S50	T	C	3	9	GR GR	3 1/4 3 1/4	19 3/4 19 3/4	3/16 3/16		A A	N	279512
15	19 3/8	3	LIFT TRUCKS & LOADERS	CLARK ANGLED CRNRS	X	C	4	9	SQ SQ	3 3	19 3/4 19 3/4	C C		A A	N	289037
15	20 5/8	2 1/4	FIAT ALLIS	170	X	C	3	9	GR GR	3 1/2 3 1/2	21 1/2 21 1/2	3/16 3/16		A A	N	221860
15 1/8	17 1/16	1 1/4	JEEP		VT	C	2	12	BU GR	3 3/16 1 11/16	17 3/8 16 3/4	C C		A A	N	124975
15 1/8	18 11/16	1 1/4	RAMBLER		VT	C	2	14	GR GR	2 7/8 1 3/4	18 1/4 18 1/2	FF FF		A A	N	124571
15 1/8	18 11/16	1 1/4	CHRYSLER		VT	C	2	14	GR GR	2 7/8 1 3/4	18 1/4 18 1/2	3/16 C		A A	N	128398
15 1/8	18 11/16	2	AMC		VT	C	3	12		2 7/8 2 1/8	18 1/4 18 1/2	1/8 C		0 0	N	128431
15 1/8	19 3/8	3	LIFT TRUCKS & LOADERS	CLARK	X	C	4	7	GR GR	3 1/2 3 1/2	19 7/8 19 7/8	C C		A A	N	266003
15 3/16	17 1/16	1 1/4	FORD		VT	C	2	12	BU GR	3 1/8 1 5/8	17 3/8 16 3/4	C C		A A	N	122281
15 3/16	17 5/8	1 1/4	JEEP		VT	C	2	14	BU GR	3 3/16 1 11/16	17 7/16 16 3/4	C C		A A	N	122265
15 3/16	17 5/8	1 1/4	JEEP		VT	C	2	12	BU GR	3 1/8 1 5/8	17 3/8 16 3/4	C C		A A	N	128596
15 1/4	12 5/8	1 1/4	TRIUMPH		VT	C	2	16	GR GR	2 2	12 3/8 12 3/8	C C		A A	N	128126
15 1/4	15 5/8	2 1/4	FIAT ALLIS	D-14	X	C	3	8	GR GR	3 3/8 3 3/8	15 7/8 15 7/8	3/16 3/16		A A	N	289507
15 1/4	15 3/4	2 1/4	FIAT ALLIS		T	C	3	7	GR GR	3 3/8 3 3/8	15 7/8 15 7/8	1/8 1/8		A A	N	278590
15 1/4	16 1/4	1 7/8	LIFT TRUCKS & LOADERS	CLARK C-20B	X	C	2	9	GR GR	2 1/4 2 1/4	17 3/8 17 3/8	C C		A A	N	288827
15 1/4	17 1/16	1 1/4	PINTO		VT	C	2	13	BU GR	3 1/8 1 5/8	17 3/8 16 3/4	C C		A A	N	124567
15 1/4	17 1/16	1 1/4	FORD		VT	C	2	12	BU GR	3 1/8 1 5/8	17 3/8 16 3/4	C C		A A	N	124720
15 1/4	17 1/16	1 1/4	FORD		VT	C	2	14	BU GR	3 1/8 1 5/8	17 3/8 16 3/4	C C		A A	N	128606
15 1/4	17 1/16	2	FORD		VT	C	3	12	BU FR	3 1/8 2 3/16	17 3/8 16 3/4	C C		A A	N	128334
15 1/4	17 1/16	2	FORD		VT	C	3	12	BU GR	3 1/8 2 3/16	17 3/8 16 3/4	C C		A A	N	128335
15 1/4	17 5/8	1 1/4	FORD		VT	C	2	12	GR GR	1 7/8 1 7/8	17 3/4 17 3/4	C C		A A	N	124586
15 1/4	17 5/8	1 1/4	TOYOTA		VT	C	2	12		3 5/16 1 7/8	17 3/4 17 11/16	5/16 C		0 0	N	124522
15 1/4	18 1/8	2 15/16	CASE/INTERNATIONAL		Z	C	4	9	GR GR	4 4	18 3/4 18 3/4	3/16 3/16		A A	N	225314
15 1/4	19 1/8	3	LIFT TRUCKS & LOADERS	MOBILE LIFT	T	C	4	9	GR GR	3 3/8 3 3/8	19 3/4 19 3/4	C C		A A	N	279514
15 1/4	19 3/8	2 1/4	LIFT TRUCKS & LOADERS	TOYOTA LIFT	X	C	3	8	GR GR	2 3/4 2 3/4	19 3/4 19 3/4	3/16 3/16		A A	N	286637
15 1/4	19 3/8	2 15/16	LIFT TRUCKS & LOADERS	MOBILE LIFT	Z	C	4	7	GR GR	3 3/8 3 3/8	19 3/4 19 3/4	C C		A A	N	286334
15 1/4	19 11/16	2 1/4	LIFT TRUCKS & LOADERS	TOYOTA LIFT	T	C	3	8	GR GR	2 3/4 2 3/4	19 3/4 19 3/4	C C		A A	N	279515
15 1/4	19 13/16	2	MERCEDES BENZ		VT	C	3	14	GR GR	2 1/8 2 1/8	20 1/8 20 1/8	C C		A A	N	122695
15 1/4	20 3/8	1 1/4	MUSTANG		VT	C	2	12	BU GR	3 3/16 1 5/8	20 7/16 19 13/16	C C		A A	N	124933
15 1/4	20 3/8	2	MERCEDES BENZ		VT	C	3	12	GR GR	2 1/16 2 1/16	20 1/16 20 1/16	C C		A A	N	128373

Vista-Pro Automotive - Core Catalog
(Cores Sorted by Size)

Height	Width	Depth	Application	Description	Fin Type	Fin Matl	Rows	FPI	BH / TH Type	BH / TH Width	BH / TH Length	BH / TH OHF	BH / TH Bolts	BH / TH Shape	Hdr Support	Model #
15 1/4	21 7/16	1 1/4	ISUZU		VT	C	2	16	GR GR	1 7/8 1 7/8	21 7/8 21 7/8	C C		A A	N	128204
15 1/4	21 7/16	2	JAGUAR		VT	C	3	16	GR GR	3 3	21 3/4 21 3/4	C C		A A	N	128371
15 1/4	21 1/2	2 1/4	JAGUAR		VE	C	4	14	GR GR	3 3	21 3/4 21 3/4	C C		A A	N	122680
15 1/4	23 1/8	1 1/4	VOLVO		VT	C	2	12	GR GR	2 3/8 2 3/8	23 5/8 23 5/8	C C		A A	N	128678
15 1/4	27 1/2	2 5/8	JAGUAR		VT	C	4	12	GR GR	3 1/16 3 1/16	27 3/4 27 3/4	C C		A A	N	124629
15 1/4	27 9/16	2 1/4	FERRARI		T	C	3	11	GR GR	5 1/8 2 3/8	27 7/8 27 7/8	3/8 3/8		A A	N	265051
15 5/16	13 3/4	2	AUDI		VT	C	3	16	GR GR	2 3/8 2 3/8	13 7/8 13 7/8	C C		A A	N	128415
15 3/8	16 5/16	2 1/4	OLIVER HART PARR	60	T	C	3	7	GR GR	6 7/8 3	16 5/8 16 5/8	1/4 1/4		A A	N	263032
15 3/8	18 9/16	3	LIFT TRUCKS & LOADERS	CLARK, HYSTER	T	C	4	8	GR GR	3 7/16 3 7/16	19 7/8 19 7/8	1/8 1/8		A A	N	223605
15 3/8	19	3	LIFT TRUCKS & LOADERS	TOYOTA LIFT	B	C	4	6		3 3	19 5/8 19 5/8	C C		0 0	N	229500
15 3/8	19 3/8	2 15/16	LIFT TRUCKS & LOADERS	TOYOTA LIFT	Z	C	4	8	SQ SQ	3 1/16 3 1/16	19 1/2 19 1/2	C C		A A	N	282652
15 3/8	19 11/16	2 1/4	LIFT TRUCKS & LOADERS	TOYOTA LIFT	T	C	3	9	GR GR	2 3/4 2 3/4	19 3/4 19 3/4	C C		A A	N	265602
15 1/2	14 3/8	2 1/4	JOHN DEERE	1010 DIESEL	X	C	3	8	GR GR	3 1/2 3 1/2	15 3/4 15 3/4	3/16 3/16		A A	N	288562
15 1/2	14 3/8	2 7/8	JOHN DEERE	1010 DIESEL AT13096	S	C	5	8	GR GR	3 7/16 3 7/16	15 3/4 15 3/4	C C		A A	N	229001
15 1/2	14 3/8	3	JOHN DEERE	1010 DIESEL	X	C	4	8	GR GR	3 7/16 3 7/16	15 3/4 15 3/4	C C		A A	N	287948
15 1/2	14 5/8	2 1/4	JOHN DEERE	1010 DIESEL	T	C	3	8	GR GR	3 7/16 3 7/16	15 3/4 15 3/4	1/8 1/8		A A	N	278917
15 1/2	16 5/16	2 1/4	OLIVER HART PARR		T	C	3	7	GR GR	6 5/8 3	16 3/4 16 3/4	1/8 1/8		A A	N	273032
15 1/2	16 7/8	2 1/4	LIFT TRUCKS & LOADERS	C-20, C-20B	T	C	3	8	GR GR	3 3/8 2 1/4	17 3/4 17 3/4	1/8 1/8		A A	N	274630
15 1/2	18 11/16	1 1/4	BUICK		VT	C	2	12	GR GR	2 1/4 2 1/4	18 1/2 18 1/2	C C		A A	N	122363
15 1/2	18 11/16	2	GM		VT	C	3	12	GR GR	2 1/4 2 1/4	18 1/2 18 1/2	C C		0 A	N	122490
15 1/2	18 3/4	2 3/16	LIFT TRUCKS & LOADERS	HYSTER	Z	C	3	10	SQ SQ	3 1/2 3 1/2	19 3/4 19 3/4	3/16 3/16		A A	N	288032
15 1/2	18 3/4	2 15/16	LIFT TRUCKS & LOADERS	HYSTER, CLARK	Z	C	4	9	GR GR	3 1/2 3 1/2	19 3/4 19 3/4	C C		A A	N	288030
15 1/2	19 3/8	2 7/8	LIFT TRUCKS & LOADERS	HYSTER	S	C	5	6	GR GR	3 1/2 3 1/2	19 3/4 19 3/4	C C		A A	N	266135
15 1/2	19 11/16	3	LIFT TRUCKS & LOADERS	HYSTER	T	C	4	8	GR GR	3 1/2 3 1/2	20 20	1/4 1/4		A A	N	261527
15 1/2	19 13/16	2	FORD		VT	C	3	12	GR GR	2 5/16 2 5/16	19 7/8 19 7/8	C C		A A	N	124746
15 1/2	20 3/8	2	FORD		VT	C	3	13	GR GR	2 5/16 2 5/16	19 7/8 19 7/8	C C		A A	N	124540
15 1/2	20 3/8	2 5/8	FORD		VT	C	4	12	GR GR	2 3/4 2 3/4	19 7/8 19 7/8	C C		A A	N	128676
15 1/2	20 7/8	1 1/4	ISUZU		VT	C	2	16	GR GR	2 2	21 21	C C		A A	N	122440
15 1/2	21 7/16	2 5/8	JAGUAR		VT	C	4	12	GR GR	3 1/4 3 1/4	21 3/4 21 3/4	C C		A A	N	128513
15 1/2	23 1/8	1 1/4	GM		VT	C	2	12	GR GR	2 2	23 1/2 23 1/2	C C		A A	N	122345
15 1/2	23 1/8	1 1/4	GM		VT	C	2	12	GR GR	2 1/2 2	23 1/2 23 1/2	1/4 C		A A	N	122358
15 1/2	23 1/8	2	CHEVROLET		VT	C	3	14	GR FR	2 1/2 2 1/16	23 1/2 23 1/2	C C		A A	N	122601

Vista-Pro Automotive - Core Catalog
(Cores Sorted by Size)

Height	Width	Depth	Application	Description	Fin Type	Fin Matl	Rows	FPI	BH / TH Type	BH / TH Width	BH / TH Length	BH / TH OHF	BH / TH Bolts	BH / TH Shape	Hdr Support	Model #
15 1/2	23 1/8	2	GM		VT	C	3	12	FR FR	2 1/16 2 1/16	23 1/2 23 1/2	C C		0 0	N	122606
15 1/2	23 1/8	2	GM		VT	C	3	12	GR GR	2 1/2 2 1/4	23 1/2 23 1/2	C C		A A	N	122303
15 1/2	23 1/8	2	VOLVO		VT	C	3	12	GR GR	2 1/4 2 1/4	23 1/2 23 1/2	C C		A A	N	122471
15 1/2	23 5/8	2	GM		VT	C	3	12	GR GR	2 1/2 2 1/8	23 1/2 23 1/2	C C		A A	N	128609
15 1/2	23 5/8	2 5/8	GM		VT	C	4	12	GR GR	2 3/4 2 3/4	23 1/2 23 1/2	C C		A A	N	128404
15 1/2	24 3/16	1 1/4	WILLYS		VT	C	2	12	GR GR	2 7/8 2 7/8	24 1/4 24 1/4	1/8 1/8		A A	N	124836
15 1/2	24 3/16	2	WILLYS		VT	C	3	13	GR GR	2 7/8 2 7/8	24 1/4 24 1/4	1/8 1/8		A A	N	124837
15 1/2	25	3 3/4	TIMBER JACK		X	C	5	9	SQ SQ	4 3/4 4 3/4	26 26	C C		A A	N	286874
15 1/2	25 5/16	1 1/4	OLDSMOBILE		VT	C	2	12	GR GR	3 2 3/4	25 7/16 25 7/16	C C		A A	N	122480
15 1/2	25 5/16	2	BUICK		VT	C	3	12	GR GR	3 2 3/4	25 7/16 25 7/16	C C		A A	N	122472
15 1/2	25 5/16	2	CHEVROLET		VT	C	3	12	GR GR	2 1/2 2 1/2	25 7/16 25 7/16	C C		A A	N	122294
15 1/2	25 5/16	2	TEMPEST		VT	C	3	12	GR GR	2 3/4 2 3/4	25 7/16 25 7/16	C C		A A	N	122347
15 1/2	25 5/16	2 5/8	GM		VT	C	4	12	GR GR	2 3/4 2 3/4	25 7/16 25 7/16	C C		A A	N	128354
15 1/2	25 5/16	2 5/8	OLDSMOBILE		VT	C	4	12	GR GR	3 3/8 3 3/8	25 7/16 25 7/16	C C		A A	N	122389
15 1/2	25 5/16	2 5/8	GM		VT	C	4	12	GR GR	3 2 3/4	25 7/16 25 7/16	C C		A A	N	128353
15 1/2	37 15/16	2 5/8	FORD		VT	C	4	16	GR GR	3 5/8 3 5/8	37 5/8 37 5/8	C C		A A	N	128565
15 9/16	17 1/16	2	CHEVROLET	LUV	VT	C	3	14	GR GR	2 5/8 2	16 3/4 16 3/4	3/8 C		A A	N	128666
15 5/8	16 7/8	2 1/4	LIFT TRUCKS & LOADERS	TOYOTA LIFT	X	C	3	9	GR GR	3 3	17 1/4 17 1/4	C C		A A	N	221792
15 5/8	17	3	LIFT TRUCKS & LOADERS	TOYOTA LIFT	B	C	4	6	GR GR	3 3	17 1/4 17 1/4	C C		0 0	N	229653
15 5/8	17 1/16	1 1/4	INTERNATIONAL		VT	C	2	12	GR GR	3 3	16 3/4 16 3/4	C C		A A	N	128523
15 5/8	22	2	TOYOTA		VT	C	3	12	GR GR	2 3/4 2 3/4	22 1/16 22 1/16	1/8 1/8		A A	N	128645
15 5/8	24 3/16	1 1/4	WILLYS		VT	C	2	16	GR GR	2 3/4 2 1/4	24 5/8 24	3/8 3/8		A A	N	124683
15 5/8	24 3/16	2	WILLYS		VT	C	3	12	GR GR	2 3/4 2 1/4	24 5/8 24	C C		A A	N	124702
15 11/16	16 5/16	2 1/4	MB		T	C	3	11	GR GR	2 5/16 2 5/16	16 18 1/2	C C		A A	N	262893
15 3/4	12 5/8	1 1/4	HONDA		VT	C	2	12	GR GR	1 3/4 1 3/4	12 7/16 12 7/16	C C		A A	N	128119
15 3/4	14 3/8	2 3/16	LIFT TRUCKS & LOADERS	TOWMOTOR 420	Z	C	3	10	GR GR	4 1/4 3 1/4	15 1/8 15 1/8	1/4 1/4		A A	N	280444
15 3/4	14 5/8	2 1/4	JOHN DEERE		T	C	3	7	BL BL	5 3/4 5 3/4	15 3/4 15 3/4	C C	16 16	A A	C	270162
15 3/4	14 5/8	2 1/4	LIFT TRUCKS & LOADERS	CLARK	T	C	3	8	GR GR	4 1/2 3 1/2	15 1/4 15 1/4	1/8 1/8		A A	N	276882
15 3/4	15	2 15/16	LIFT TRUCKS & LOADERS	TOWMOTOR	Z	C	4	9	GR GR	4 3/8 3 1/4	15 15	3/16 3/16		A A	N	289760
15 3/4	15 5/8	2 1/4	AJAX	5 X 6 1/2	X	C	3	8	GR GR	3 1/2 3 1/2	16 1/2 16 1/2	1/8 1/8		A A	N	221428
15 3/4	15 5/8	2 1/4	INT'L HARVESTER		X	C	3	8	GR GR	3 3	16 1/4 16 1/4	C C		A A	N	281655
15 3/4	15 3/4	2 1/4	CASE/INTERNATIONAL	430 TRACTOR	T	C	3	8	GR GR	6 2 3/8	15 7/8 15 7/8	1/4 C		A A	N	223244

Vista-Pro Automotive - Core Catalog
(Cores Sorted by Size)

Height	Width	Depth	Application	Description	Fin Type	Fin Matl	Rows	FPI	BH / TH Type	BH / TH Width	BH / TH Length	BH / TH OHF	BH / TH Bolts	BH / TH Shape	Hdr Support	Model #
15 3/4	16 1/4	2 15/16	LIFT TRUCKS & LOADERS	TOWMOTOR	Z	C	4	9	GR	3 3/4	16 5/8	3/16		A	N	289529
									GR	3 1/4	16 5/8	3/16	A			
15 3/4	16 1/4	3 3/4	LIFT TRUCKS & LOADERS	TOWMOTOR	X	C	5	7	SQ	5 1/8	16 5/8	3/16		A	N	286636
									SQ	5 1/8	16 5/8	3/16	A			
15 3/4	16 5/16	3	LIFT TRUCKS & LOADERS	TOWMOTOR	T	C	4	6	GR	4	16 1/2	1/4		A	N	223240
									GR	3 1/4	16 1/2	1/4	A			
15 3/4	16 5/16	3 3/4	LIFT TRUCKS & LOADERS	TOWMOTOR	T	C	5	7	GR	5 1/8	16 5/8	3/16		A	N	279520
									GR	5 1/8	16 5/8	3/16	A			
15 3/4	16 1/2	1 1/4	CHRYSLER		VT	C	2	16	GR	1 7/8	16 5/8	C		A	N	128729
									GR	1 7/8	16 5/8	C	A			
15 3/4	16 1/2	3	LIFT TRUCKS & LOADERS	TOWMOTOR	B	C	4	7	GR	4	16 1/2	1/8		A	N	277422
									GR	3 1/4	16 1/2	C	A			
15 3/4	16 7/8	1 7/8	FAIRBANKS-MORSE	ZC-346 HVY BTM HDR W/TANK & SIDES	X	C	2	7	SQ	2	16 13/16	C		A	C	221328
									BH	3 5/8	20 1/2	C	11	A		
15 3/4	16 7/8	2 1/4	LIFT TRUCKS & LOADERS	KOMATSU	X	C	3	8	GR	3 1/8	17 1/4	C		A	N	282799
									GR	3 1/8	17 1/4	C	A			
15 3/4	16 7/8	2 1/4	LIFT TRUCKS & LOADERS	MAZDA	X	C	3	8	GR	3	17	C		A	N	286901
									GR	3	17	C	A			
15 3/4	16 7/8	2 7/8	LIFT TRUCKS & LOADERS	KOMATSU	S	C	5	8	GR	3 1/8	17 1/4	C		A	N	229201
									GR	3 1/8	17 1/4	C	A			
15 3/4	16 7/8	2 15/16	LIFT TRUCKS & LOADERS	MUSTANG SKID LOADER	Z	C	4	11	GR	3 1/8	17 1/4	C		A	N	225520
									GR	3 1/8	17 1/4	C	A			
15 3/4	17	3	LIFT TRUCKS & LOADERS	TOYOTA LIFT	B	C	4	8	GR	3 1/8	17 1/4	C		A	N	229518
									GR	3 1/8	17 1/4	C	A			
15 3/4	17	3	LIFT TRUCKS & LOADERS		B	B	4	6	GR	3	17 1/4	C		A	N	229668
									GR	3	17 1/4	C	A			
15 3/4	17 1/16	1 1/4	WILLYS		VT	C	2	12	GR	2 3/4	16 5/8	5/8		A	N	124699
									GR	2 3/4	16 5/8	5/16	A			
15 3/4	17 1/16	2	JEEP		VT	C	3	14	GR	2 3/4	16 5/8	C		A	N	128448
									GR	2 3/4	16 5/8	C	A			
15 3/4	17 1/16	2 5/8	KOMATSU LIFT		VT	C	4	13	GR	3 1/8	17 1/4	C		A	N	128823
									GR	3 1/8	17 1/4	C	A			
15 3/4	17 1/16	2 5/8	LIFT TRUCKS & LOADERS		VT	C	4	12	GR	3	17 3/16	C		A	N	124955
									GR	3	17 3/16	C	A			
15 3/4	17 7/16	3	LIFT TRUCKS & LOADERS	HYSTER	T	C	4	8	GR	3 1/2	17 3/4	1/8		A	N	279522
									GR	3 1/2	17 3/4	1/8	A			
15 3/4	17 1/2	2 15/16	LIFT TRUCKS & LOADERS	TOWMOTOR	Z	C	4	9	GR	4	18	3/16		A	N	286885
									GR	4	18	3/16	A			
15 3/4	17 1/2	3	LIFT TRUCKS & LOADERS	HYSTER	X	C	4	8	GR	3 1/2	17 3/4	C		A	N	289974
									GR	3 1/2	17 3/4	C	A			
15 3/4	17 1/2	4 7/16	LIFT TRUCKS & LOADERS	HYSTER 344816	S	C	8	7	GR	5 3/4	17 7/8	C		A	N	229130
									GR	5 3/4	17 7/8	C	A			
15 3/4	18	3	LIFT TRUCKS & LOADERS	HYSTER	T	C	4	8	GR	3 3/4	17 7/8	1/8		A	N	279519
									GR	3 3/4	17 7/8	1/8	A			
15 3/4	18 1/8	2	FORD TRUCK		VT	C	3	12	GR	2 7/16	18 1/4	C		A	N	124938
									GR	2 7/16	18 1/4	C	A			
15 3/4	18 9/16	3	LIFT TRUCKS & LOADERS	CLARK 1672280	T	C	4	10	GR	3 3/8	19 7/8	C		A	N	264095
									GR	3 3/8	19 7/8	C	A			
15 3/4	18 11/16	1 1/4	MERCEDES BENZ		VT	C	2	14	GR	2 1/2	18 5/8	C		A	N	128340
									GR	2 1/2	18 5/8	C	A			
15 3/4	18 11/16	2	MERCEDES BENZ		VT	C	3	14	GR	2 1/2	18 5/8	C		A	N	128813
									GR	2 1/2	18 5/8	C	A			
15 3/4	18 11/16	2	MERCEDES-BENZ		VT	C	3	12	GR	2 1/4	18 1/2	C		A	N	128438
									GR	2 1/4	18 1/2	C	A			
15 3/4	18 3/4	3	LIFT TRUCKS & LOADERS	CLARK	X	C	4	8	GR	3 1/2	19 7/8	3/16		A	N	289048
									GR	3 1/2	19 7/8	3/16	A			
15 3/4	19 1/8	2 1/4	LIFT TRUCKS & LOADERS	CLARK	T	C	3	9	GR	3 1/2	19 3/4	3/16		A	N	279525
									GR	3 1/2	19 3/4	3/16	A			
15 3/4	19 1/4	1 1/4	TOYOTA		VT	C	2	14	GR	1 3/4	19 1/2	C		A	N	124713
									GR	1 3/4	19 1/2	C	A			
15 3/4	19 1/4	2	TOYOTA		VT	C	3	12	GR	2 1/2	19 1/2	C		A	N	124714
									GR	2 1/2	19 1/2	C	A			
15 3/4	19 3/8	2 1/4	LIFT TRUCKS & LOADERS	CLARK	X	C	3	9	GR	3 1/2	19 3/4	1		A	N	266190
									GR	3 1/2	19 3/4	1	A			

Vista-Pro Automotive - Core Catalog
(Cores Sorted by Size)

Height	Width	Depth	Application	Description	Fin Type	Fin Matl	Rows	FPI	BH / TH Type	BH / TH Width	BH / TH Length	BH / TH OHF	BH / TH Bolts	BH / TH Shape	Hdr Support	Model #
15 3/4	19 3/8	2 1/4	LIFT TRUCKS & LOADERS	TOYOTA LIFT	X	C	3	11	GR GR	3 1/8 2 3/4	19 3/4 19 3/4	C 1/2		A A	N	286380
15 3/4	19 3/8	2 1/4	LIFT TRUCKS & LOADERS	CLARK	X	C	3	10	GR GR	3 1/2 3 1/2	19 3/4 19 3/4	3/16 3/16		A A	N	289890
15 3/4	19 11/16	2 1/4	LIFT TRUCKS & LOADERS	TOYOTA LIFT	T	C	3	11	GR GR	3 1/8 2 3/4	19 3/4 19 3/4	C C		A A	N	279524
15 3/4	19 11/16	3	LIFT TRUCKS & LOADERS	TOYOTA LIFT	T	C	4	9	GR GR	3 3/8 3 3/8	19 5/8 19 5/8	C C		A A	N	223608
15 3/4	20 7/8	2	TOYOTA		VT	C	3	12	GR GR	2 1/2 2 1/2	21 21	C C		A A	N	124775
15 3/4	21 1/16	1	TOYOTA		VE	C	2	16	GR GR	1 7/8 1 7/8	21 21	C C		A A	N	128276
15 3/4	22	2 5/8	TOYOTA		VT	C	4	12	GR GR	2 3/4 2 3/4	22 22	C C		0 A	N	124607
15 3/4	24 3/16	1 1/4	RAMBLER		VT	C	2	12	GR GR	2 3/4 1 3/4	24 5/8 24	5/8 C		A A	N	122577
15 3/4	24 3/16	2	RAMBLER		VT	C	3	12	GR GR	2 13/16 2 1/4	24 5/8 24	C C		A A	N	124520
15 3/4	24 3/16	2	AMC		VT	C	3	12	GR GR	2 13/16 2 1/4	24 5/8 24 5/8	C C		A A	N	124575
15 3/4	24 3/16	2 5/8	TOYOTA		VT	C	4	12	GR GR	3 3	24 1/4 24 1/4	C C		A A	N	128688
15 3/4	25 5/16	1 1/4	TOYOTA		VT	C	2	14	GR GR	1 7/8 1 7/8	25 3/4 25 3/4	C C		A A	N	124980
15 3/4	25 7/8	1 1/4	AMC		VT	C	2	12		2 2	25 9/16 25 9/16	3/8 3/8		0 0	N	128502
15 3/4	25 7/8	2	JEEP		VT	C	3	14		3 2 1/16	25 5/8 25 5/8	C C		0 0	N	128405
15 7/8	14 5/8	2 1/4	LIFT TRUCKS & LOADERS	TOWMOTOR LT40	T	C	3	8	GR GR	4 1/4 3 1/4	15 15	3/16 3/16		A A	N	223259
15 7/8	14 5/8	3	LIFT TRUCKS & LOADERS	TOWMOTOR	T	C	4	8	GR GR	4 1/4 3 1/4	15 15	1/4 1/4		A A	N	260957
15 7/8	15 5/8	2 3/16	CASE/INTERNATIONAL		Z	C	3	8	GR GR	5 7/8 2 3/8	15 3/4 15 3/4	3/16 C		A A	N	225315
15 7/8	15 5/8	2 1/4	CLIMAX	C-66, C-96 CONDENSER HVY BTM HDR W/TANK & SIDES	X	C	3	7	SQ BH	2 7/8 4 1/2	15 3/4 17 3/4	C C		A A	C	221804
15 7/8	16 1/4	2 1/4	WITTE	R72, 98 CONDENSER HVY BTM HDR W/TANK & SIDES	X	C	3	7	SQ BH	2 3/4 4 9/16	16 3/8 20	C C	18	A A	C	221853
15 7/8	16 1/4	3	LIFT TRUCKS & LOADERS	TOWMOTOR	X	C	4	7	GR GR	4 3 1/4	16 5/8 16 5/8	3/16 C		A A	N	289759
15 7/8	17 1/2	2 7/8	LIFT TRUCKS & LOADERS	HYSTER 261190	S	C	5	7	GR GR	3 7/16 3 7/16	17 3/4 17 3/4	C C		A A	N	229131
15 7/8	18 9/16	3	LIFT TRUCKS & LOADERS	620 CLARK	T	C	4	9	GR GR	3 7/16 3 7/16	19 3/4 19 3/4	C C		A A	N	277197
15 7/8	23 1/8	1 1/4	FORD		VT	C	2	12	GR GR	2 1/2 1 5/8	22 7/8 22 3/4	C C		A A	N	124533
15 7/8	23 1/8	2	FORD		VT	C	3	12	GR GR	2 1/2 2 1/2	22 7/8 22 7/8	C C		A A	N	122535
15 7/8	25 7/8	2	WILLYS		VT	C	3	12	GR GR	3 2 3/4	25 9/16 25 9/16	C C		A A	N	122277
15 7/8	25 7/8	2	WILLYS		VT	C	3	14	GR GR	3 3	25 9/16 25 9/16	C C		A A	N	124519
15 7/8	25 7/8	2 5/8	JEEP		VT	C	4	12	GR GR	3 3	25 9/16 25 9/16	C C		A A	N	128634
15 7/8	30 1/8	1 9/16	DODGE TRK	WITH DIESEL	VE	C	3	17	GR GR	1 7/8 1 7/8	30 7/8 30 7/8	C C		A A	N	128853
16	14 3/8	2 1/4	LIFT TRUCKS & LOADERS	CASE	X	C	3	8	GR GR	2 7/8 2 7/8	15 15	C C		A A	N	286860
16	14 5/8	3	LIFT TRUCKS & LOADERS	CLARK	T	C	4	8	GR GR	4 3 1/8	15 15	C C		A A	N	279540
16	15 3/4	2 1/4	CASE/INTERNATIONAL	300 DIESEL	T	C	3	7	GR FR	4 1/2 2 3/8	15 5/8 15 5/8	1/8 C		A A	N	223009
16	15 3/4	2 1/4	CASE/INTERNATIONAL	320	T	C	3	7	GR GR	4 1/4 2 3/4	15 5/8 15 5/8	1/4 1/4		A A	N	262942

Vista-Pro Automotive - Core Catalog
(Cores Sorted by Size)

Height	Width	Depth	Application	Description	Fin Type	Fin Matl	Rows	FPI	BH / TH Type	BH / TH Width	BH / TH Length	BH / TH OHF	BH / TH Bolts	BH / TH Shape	Hdr Support	Model #
16	16 1/4	2 15/16	LIFT TRUCKS & LOADERS	TOWMOTOR	Z	C	4	7	GR GR	4 1/2 3 1/4	16 1/2 16 1/2	3/16 C		A A	N	289162
16	16 5/16	3	LIFT TRUCKS & LOADERS	TOWMOTOR	T	C	4	7	GR GR	4 1/2 3 1/4	16 1/2 16 1/2	1/8 C		A A	N	279533
16	16 5/16	3	LIFT TRUCKS & LOADERS	TOWMOTOR	T	C	4	7	GR GR	4 3 1/4	16 1/2 16 1/2	1/8 1/8		A A	N	279534
16	16 5/16	3 3/4	LIFT TRUCKS & LOADERS	TOWMOTOR	T	C	5	8	GR GR	5 5	16 1/2 16 1/2	3/4 3/4		A A	N	279536
16	16 1/2	1 1/4	GM		VT	C	2	12	GR GR	2 3/4 2	17 17	C C		A A	N	128110
16	16 7/8	2 3/16	LIFT TRUCKS & LOADERS	YALE	Z	C	3	9	GR GR	3 1/2 3 1/2	17 7/8 17 7/8	3/16 3/16		A A	N	286383
16	16 7/8	2 3/16	LIFT TRUCKS & LOADERS	TOWMOTOR	Z	C	3	9	SQ SQ	5 3/4 3 1/2	17 7/8 17 7/8	3/16 3/16		A A	N	288123
16	16 7/8	2 15/16	LIFT TRUCKS & LOADERS	TOYOTA LIFT	Z	C	4	10	SQ SQ	3 3	17 1/4 17 1/4	C C		A A	N	286381
16	16 7/8	3	LIFT TRUCKS & LOADERS	TOYOTA LIFT	T	C	4	9		3 3	17 1/4 17 1/4	C C		0 0	N	279539
16	17 7/16	2 1/4	FORD TRACTOR	3000, 4000	T	C	3	8	GR GR	3 5/8 2 7/8	18 1/8 18 1/8	1/2 1/2		A A	N	223130
16	17 7/16	2 1/4	FORD TRACTOR	3000, 4000	T	C	3	8	GR GR	4 2 7/8	17 3/4 17 3/4	1/2 1/4		A A	N	223147
16	17 7/16	2 1/4	FORD TRACTOR	3000, 4000	T	C	3	7	GR GR	3 1/2 2 7/8	17 3/4 17 3/4	1/2 1/4		A A	N	223628
16	17 7/16	2 1/4	LIFT TRUCKS & LOADERS	TOWMOTOR	T	C	3	8	GR GR	4 1/8 2 7/8	18 18	C C		A A	N	279538
16	17 7/16	3	LIFT TRUCKS & LOADERS	HYSTER	T	C	4	9	GR GR	3 7/8 3 7/8	17 7/8 17 7/8	C C		A A	N	279535
16	17 1/2	2 1/4	FORD TRACTOR		X	C	3	6	GR GR	3 5/8 2 7/8	18 1/8 18 1/8	1/2 1/2		A A	N	221808
16	17 1/2	2 1/4	FORD TRACTOR	3000	X	C	3	6	GR GR	4 2 7/8	17 3/4 17 3/4	1/2 1/2		A A	N	221822
16	17 1/2	2 1/4	LIFT TRUCKS & LOADERS	TOWMOTOR	X	C	3	8	GR GR	4 1/8 2 7/8	18 18	3/8 1/2		A A	N	286382
16	17 1/2	2 15/16	LIFT TRUCKS & LOADERS	HYSTER	Z	C	4	9	GR GR	3 7/8 3 7/8	17 7/8 17 7/8	1/4 1/4		A A	N	286576
16	22 1/2	3	LIFT TRUCKS & LOADERS	CLARK	T	C	4	8	GR GR	3 1/2 3 1/2	23 3/4 23 3/4	C C		A A	N	260764
16	23 1/8	2 5/8	FORD		VT	C	4	12	GR GR	2 3/4 2 3/4	23 23	C C		A A	N	128675
16	24 3/16	1 1/4	MUSTANG		VT	C	2	12	GR GR	2 3/4 2 3/4	23 7/8 23 7/8	C C		A A	N	122562
16	24 3/16	2	DATSUN		VT	C	3	12	GR GR	2 5/8 2 7/16	24 1/2 24 1/2	C C		A A	N	124779
16	24 3/16	2	MERCEDES BENZ		VT	C	3	14	GR GR	2 3/8 2 3/8	23 7/8 23 7/8	C C		A A	N	124776
16	24 3/16	2	MUSTANG		VT	C	3	12	GR GR	2 3/4 2 3/4	23 7/8 23 7/8	C C		A A	N	122578
16	24 3/16	2	JEEP		VT	C	3	12	GR GR	2 3/4 2 3/4	24 1/4 24 1/4	C C		A A	N	128457
16	24 3/16	2 5/8	FORD		VT	C	4	12	GR GR	2 3/4 2 3/4	23 7/8 23 7/8	C C		A A	N	128674
16	25 5/16	1 1/4	GM		VT	C	2	12	GR GR	2 1/2 2 1/2	25 7/16 25 7/16	C C		A A	N	128643
16	25 5/16	2	GM		VT	C	3	12	GR GR	2 1/2 2 1/2	25 7/16 25 7/16	C C		A A	N	122517
16	25 7/8	1 1/4	WILLYS		VT	C	2	16	GR GR	3 2	25 9/16 25 9/16	3/16 3/16		A A	N	124748
16	25 7/8	2	WILLYS		VT	C	3	12	GR GR	3 2 3/4	25 9/16 25 9/16	C C		A A	N	124747
16	26 3/8	2	JEEP		VT	C	3	12	GR GR	3 3	26 3/4 26 3/4	C C		A A	N	124835
16	26 15/16	1 1/4	MERCEDES-BENZ		VT	C	2	12	GR GR	2 1/8 2 1/8	27 1/2 27 1/2	C C		A A	N	124858

Vista-Pro Automotive - Core Catalog
(Cores Sorted by Size)

Height	Width	Depth	Application	Description	Fin Type	Fin Matl	Rows	FPI	BH / TH Type	BH / TH Width	BH / TH Length	BH / TH OHF	BH / TH Bolts	BH / TH Shape	Hdr Support	Model #
16	26 15/16	2	MERCEDES BENZ		VT	C	3	14	GR GR	2 1/8 2 1/8	27 1/4 27 1/4	C C		A A	N	124859
16	27 1/4	1 9/16	MERCEDES BENZ		VE	C	3	14	GR GR	2 1/8 2 1/8	27 1/4 27 1/4	C C		A A	N	122681
16 1/8	14 1/16	1	GM	VE-8547 CORE	VE	C	2	14	GR GR	1 13/16 1 13/16	14 9/16 14 9/16	C C		A A	N	128547
16 1/8	15 5/8	2 3/16	INT'L HARVESTER	140	Z	C	3	7	GR GR	6 3/8 3 1/16	16 1/4 16 1/4	1/2 1/2		A A	N	225449
16 1/8	15 5/8	2 1/4	INT'L HARVESTER	FARMALL SUPER C	X	C	3	8	GR GR	6 3	16 1/4 16 1/4	1/4 1/4		A A	N	288183
16 1/8	15 3/4	2 1/4	INT'L HARVESTER	140	T	C	3	9	GR GR	6 3/8 3 1/16	16 1/4 16 1/4	1/2 1/2		A A	N	223191
16 1/8	16 1/4	2 15/16	LIFT TRUCKS & LOADERS	YALE	Z	C	4	10	GR SQ	6 1/4 3 1/8	16 1/4 16 1/4	3/16 C		A A	N	288224
16 1/8	16 1/4	3	LIFT TRUCKS & LOADERS	TOYOTA LIFT	X	C	4	9	GR GR	4 4	16 3/8 16 3/8	C C		A A	N	221793
16 1/8	16 5/16	3	LIFT TRUCKS & LOADERS	YALE	T	C	4	9	GR GR	6 1/4 3	16 1/4 16 1/4	3 5/16 C		A A	N	261538
16 1/8	16 5/16	3	LIFT TRUCKS & LOADERS	TOWMOTOR	T	C	4	6	GR GR	4 3 1/4	16 1/2 16 1/2	1/4 C		A A	N	265444
16 1/8	16 1/2	2	INTERNATIONAL		VT	C	3	12	GR GR	3 3	16 1/4 16 1/4	1/4 1/4		A A	N	122381
16 1/8	17 5/8	2	FORD		VT	C	3	12	GR GR	2 5/8 2 5/8	17 1/2 17 1/2	C C		A A	N	122502
16 1/8	19 1/8	2 1/4	LIFT TRUCKS & LOADERS	CLARK	T	C	3	6	GR GR	3 3/8 3 3/8	19 3/4 19 3/4	C C		A A	N	279541
16 1/8	19 1/8	3	LIFT TRUCKS & LOADERS	YALE	T	C	4	9	GR GR	3 3/8 3 3/8	19 3/4 19 3/4	1/4 1/4		A A	N	279542
16 1/8	19 3/8	2 3/16	LIFT TRUCKS & LOADERS	CLARK C-25T	Z	C	3	7	GR GR	3 3/8 3 3/8	19 3/4 19 3/4	1/4 1/4		A A	N	286531
16 1/8	19 3/8	2 15/16	LIFT TRUCKS & LOADERS	YALE	Z	C	4	10	GR GR	3 3/8 3 3/8	19 3/4 19 3/4	1/4 1/4		A A	N	289049
16 1/8	19 13/16	2	JEEP		VT	C	3	12	GR GR	3 2 3/8	19 3/4 19 11/16	C C		A A	N	128358
16 1/8	21 1/16	1	MAZDA		VE	C	2	14	GR GR	1 3/4 1 3/4	21 7/16 21 7/16	C C		A A	N	128215
16 1/8	21 1/2	1 9/16	MAZDA		VE	C	3	14	GR GR	1 3/4 1 3/4	21 7/16 21 7/16	C C		A A	N	122691
16 1/8	24 3/16	2	DATSUN		VT	C	3	14	GR GR	2 5/8 2 5/8	24 5/8 24 5/8	C C		A A	N	128808
16 1/8	24 3/16	2 5/8	NISSAN		VT	C	4	12	GR GR	2 7/8 2 7/8	24 3/8 24 3/8	C C		A A	N	128511
16 1/8	25 5/16	1 1/4	NISSAN		VT	C	2	12	GR GR	1 13/16 1 13/16	25 13/16 25 13/16	C C		A A	N	128773
16 1/8	25 7/8	2 5/8	ROLLS ROYCE		VT	C	4	14	GR GR	3 1/8 3 1/8	26 26	C C		A A	N	128387
16 1/4	13 1/8	1 7/8	MG		X	C	2	8	GR GR	8 1/4 2 3/8	13 1/2 13 1/2	3/4 C		A A	N	260773
16 1/4	13 3/16	2	AUDI		VT	C	3	12	GR GR	2 3/8 2 1/16	13 1/8 13 1/8	C C		A A	N	124761
16 1/4	14 1/16	3	LIFT TRUCKS & LOADERS	BAKER	T	C	4	6	GR GR	4 4	14 1/4 14 1/4	1/4 1/4		A A	N	264002
16 1/4	14 3/8	2 3/16	DAVID BROWN TRACTOR		Z	C	3	9	GR GR	2 7/8 2 7/8	15 15	C C		A A	N	289577
16 1/4	14 5/8	2 1/4	DAVID BROWN TRACTOR		T	C	3	8	GR GR	2 7/8 2 7/8	15 15	C C		A A	N	278915
16 1/4	15 3/16	2 1/4	OLIVER HART PARR	OC4	T	C	3	8	GR GR	3 1/2 2 3/8	15 3/4 15 3/4	1/4 1/4		A A	N	263064
16 1/4	15 5/8	2 1/4	CASE/INTERNATIONAL	320 LOADER	X	C	3	9	GR GR	4 1/4 2 1/2	15 5/8 15 5/8	3/16 3/16		A A	N	281663
16 1/4	15 3/4	2 1/4	LIFT TRUCKS & LOADERS	BAKER	T	C	3	9	GR GR	4 3/8 2 3/8	15 3/4 15 3/4	C C		A A	N	279545
16 1/4	16	3	LIFT TRUCKS & LOADERS	BAKER	B	C	4	7	GR GR	4 4	16 1/2 16 1/2	C C		A A	N	272773

Vista-Pro Automotive - Core Catalog
(Cores Sorted by Size)

Height	Width	Depth	Application	Description	Fin Type	Fin Matl	Rows	FPI	BH / TH Type	BH / TH Width	BH / TH Length	BH / TH OHF	BH / TH Bolts	BH / TH Shape	Hdr Support	Model #
16 1/4	16 1/4	2 1/4	INT'L HARVESTER	B-275 DIESEL	X	C	3	7	GR	5 1/2	17	C		A	N	221275
									GR	3 1/4	17	C	A			
16 1/4	16 1/4	2 1/4	INT'L HARVESTER	B-275 DIESEL	X	C	3	7	SQ	5 1/2	17	1/4		A	N	287530
									SQ	3 1/4	17	1/4	A			
16 1/4	16 1/4	2 3/8	INT'L HARVESTER	FARMALL 358103-R94	S	C	4	7	GR	6 3/8	16 1/4	1/8		A	N	229090
16 1/4	16 1/4	2 15/16	INT'L HARVESTER	FARMALL C	Z	C	4	9	GR	6 3/8	16 1/4	3/16		A	N	225450
									GR	3 1/16	16 1/4	C	A			
16 1/4	16 5/16	2 1/4	INT'L HARVESTER	140	T	C	3	6	GR	6 3/8	16 1/4	1/8		A	N	223176
16 1/4	16 5/16	2 1/4	OLIVER HART PARR		T	C	3	7	GR	6 3/4	16 5/8	3/16		A	N	270273
									GR	3	16 5/8	3/16	A			
16 1/4	16 5/16	3	INT'L HARVESTER	FARMALL C	T	C	4	7	GR	6 3/8	16 1/4	3/16		A	N	223180
16 1/4	16 7/8	2 7/8	FIAT ALLIS	LIFT TRUCK 4882935	S	C	5	7	GR	3 3/8	18	C		A	N	229181
									GR	3 3/8	18	C	A			
16 1/4	16 7/8	3	LIFT TRUCKS & LOADERS	ALLIS CHALMERS	T	C	4	8	GR	3 3/8	17 7/8	C		A	N	261541
									GR	3 3/8	17 7/8	C	A			
16 1/4	17 7/16	2 1/4	FIAT ALLIS		T	C	3	8	GR	3 3/8	18	1/8		A	N	223626
									GR	3 3/8	18	1/8	A			
16 1/4	17 7/16	2 1/4	LIFT TRUCKS & LOADERS	YALE	T	C	3	9	GR	3 3/8	17 3/4	1/8		A	N	223246
									GR	3 3/8	17 3/4	1/8	A			
16 1/4	17 1/2	2 3/8	LIFT TRUCKS & LOADERS	ALLIS CHALMERS LIFT	S	C	4	7	GR	3 3/8	17 7/8	1/4		A	N	266256
									GR	3 3/8	17 7/8	1/4	A			
16 1/4	18	3	FIAT ALLIS	H3 HD3	T	C	4	8	GR	5 3/8	18 1/4	3/8		A	N	277717
									GR	4 1/4	18 1/4	3/8	A			
16 1/4	18 1/8	2 1/4	FIAT ALLIS		X	C	3	8	GR	5 3/8	18 1/4	3/8		A	N	260340
									GR	2 7/8	18 1/4	3/8	A			
16 1/4	18 1/8	2 15/16	CASE/INTERNATIONAL	310, 320	Z	C	4	7	GR	4	18 7/8	3/16		A	N	225316
16 1/4	19 1/8	2 1/4	JEEP		T	C	3	10	GR	3	19 1/4	C		A	N	263566
									GR	2 1/2	19 1/4	C	A			
16 1/4	19 3/8	2 1/4	LIFT TRUCKS & LOADERS	CLARK	X	C	3	10	GR	3	19 1/2	3/8		A	N	281536
									GR	3	19 1/2	3/8	A			
16 1/4	19 3/8	2 1/4	LIFT TRUCKS & LOADERS	YALE	X	C	3	9	GR	3 1/2	20	3/16		A	N	288307
									GR	3 1/2	20	3/16	A			
16 1/4	19 3/8	2 7/8	LIFT TRUCKS & LOADERS	MOBILE LIFT	S	C	5	7	GR	3 1/2	20	C		A	N	266156
									GR	3 1/2	20	C	A			
16 1/4	25 7/8	2 5/8	JEEP		VT	C	4	12	GR	3	25 9/16	C		A	N	128509
									GR	3	25 9/16	C	A			
16 5/16	16 5/16	3	JEEP		T	C	4	10	GR	3 3/8	16 1/2	C		A	N	263182
									GR	3 3/8	16 1/2	C	A			
16 3/8	16 1/4	1 7/8	TRIUMPH		X	C	2	11	GR	2 3/4	16 1/2	C		A	N	265414
16 3/8	16 5/16	2 1/4	TRIUMPH		T	C	3	11	GR	2 3/4	16 1/2	C		A	N	264347
									GR	2 3/4	16 1/2	C	A			
16 3/8	16 1/2	2	TRIUMPH		VT	C	3	12	GR	2 3/4	16 1/2	C		A	N	124805
									GR	2 3/4	16 1/2	C	A			
16 3/8	16 1/2	2 5/8	TRIUMPH		VT	C	4	12	FR	2 3/4	16 1/2	C		A	N	128644
									FR	2 3/4	16 1/2	C	A			
16 3/8	16 7/8	3	LIFT TRUCKS & LOADERS	CLARK	X	C	4	7	GR	3 1/2	17 7/8	1/8		A	N	266089
									GR	3 1/2	17 7/8	1/8	A			
16 3/8	17 1/16	1 1/4	FORD	FALCON	VT	C	2	12	BU	3 1/8	17 3/8	C		A	N	122422
									GR	1 5/8	16 3/4	C	A			
16 3/8	17 1/16	1 1/4	MERCURY	COMET	VT	C	2	12	BU	3 3/16	17 3/8	C		A	N	124833
									GR	1 11/16	16 3/4	C	A			
16 3/8	17 1/16	1 1/4	MUSTANG		VT	C	2	12	BU	3 1/8	17 3/8	C		A	N	122361
									GR	1 5/8	16 3/4	C	A			
16 3/8	17 1/16	1 1/4	FORD		VT	C	2	12	BU	3 1/8	17 3/8	C		A	N	122501
									GR	1 5/8	16 3/4	C	A			
16 3/8	17 1/16	1 1/4	FORD		VT	C	2	12	BU	3 3/16	17 3/8	C		A	N	124743
									GR	1 5/8	16 3/4	C	A			
16 3/8	17 1/16	1 1/4	FORD		VT	C	2	12	BU	3 1/8	17 3/8	C		A	N	128616
									GR	1 5/8	16 3/4	C	A			

Vista-Pro Automotive - Core Catalog
(Cores Sorted by Size)

Height	Width	Depth	Application	Description	Fin Type	Fin Matl	Rows	FPI	BH / TH Type	BH / TH Width	BH / TH Length	BH / TH OHF	BH / TH Bolts	BH / TH Shape	Hdr Support	Model #
16 3/8	17 1/16	1 1/4	FORD		VT	C	2	12	BU	3 1/8	17 3/8	C		A	N	128617
									GR	1 5/8	16 3/4	C		A		
16 3/8	17 1/16	2	FORD	FALCON	VT	C	3	12	BU	3 1/8	17 3/8	C		A	N	122468
									GR	2 1/4	16 7/8	C		A		
16 3/8	17 1/16	2	FORD		VT	C	3	12	BU	3 1/8	17 3/8	C		A	N	122534
									GR	2 1/4	16 7/8	C		A		
16 3/8	17 1/16	2	FORD		VT	C	3	12	BU	3 1/8	17 3/8	C		A	N	124804
									GR	2 1/4	16 7/8	C		A		
16 3/8	17 1/16	2	JEEP		VT	C	3	12	GR	2 3/8	17 1/2	C		A	N	124806
									GR	2 3/8	17 1/2	C		A		
16 3/8	17 1/16	2	FORD		VT	C	3	12	BU	3 1/8	17 3/8	C		A	N	128618
									FR	2 1/8	16 3/4	C		A		
16 3/8	19 1/4	2	JEEP		VT	C	3	14	GR	3	19 1/4	C		A	N	128344
									GR	2 1/2	19 1/4	C		A		
16 3/8	20 1/4	1 9/16	FORD		VE	C	3	14	BU	3 3/16	20 7/16	C		A	N	128380
									GR	1 3/4	19 13/16	C		A		
16 3/8	20 3/8	1 1/4	FORD		VT	C	2	12	BU	3 3/16	20 7/16	C		A	N	124514
									GR	1 5/8	19 13/16	C		A		
16 3/8	20 3/8	1 1/4	MAVERICK		VT	C	2	12	BU	3 3/16	20 7/16	C		A	N	124646
									GR	1 5/8	19 13/16	C		A		
16 3/8	20 3/8	1 1/4	MUSTANG	DIMPLED TUBE	VT	C	2	12	BU	3 3/16	20 7/16	C		A	N	122533
									GR	1 5/8	19 13/16	C		A		
16 3/8	20 3/8	1 1/4	MUSTANG		VT	C	2	12	BU	3 3/16	20 7/16	C		A	N	122561
									GR	1 5/8	19 13/16	C		A		
16 3/8	20 3/8	1 1/4	PINTO		VT	C	2	12	BU	3 3/16	20 7/16	C		A	N	124832
									GR	1 5/8	19 13/16	C		A		
16 3/8	20 3/8	1 1/4	FORD		VT	C	2	12	BU	3 3/16	20 7/16	C		A	N	128624
									GR	1 5/8	19 13/16	C		A		
16 3/8	20 3/8	2	FORD		VT	C	3	12	BU	3 3/16	20 7/16	C		A	N	122268
									FR	2	19 7/8	C		A		
16 3/8	20 3/8	2	FORD		VT	C	3	12	BU	3 3/16	20 7/16	C		A	N	124689
									GR	2 5/16	19 7/8	C		A		
16 3/8	20 3/8	2	FORD		VT	C	3	12	BU	3 3/16	20 7/16	C		A	N	122608
									GR	2	19 13/16	C		A		
16 3/8	20 3/8	2	FORD		VT	C	3	12	BU	3 3/16	20 7/16	C		A	N	124690
									GR	2 5/16	19 7/8	C		A		
16 3/8	20 3/8	2	FORD		VT	C	3	12	BU	3 3/16	20 7/16	C		A	N	124695
									GR	2 5/16	19 7/8	C		A		
16 3/8	23 1/8	1 1/4	FORD		VT	C	2	12	BU	4 1/4	25 3/4	C		A	N	122233
									GR	2 1/4	23 3/4	C		A		
16 3/8	23 1/8	2	ISUZU		VT	C	3	12	BU	4 1/4	25 3/4	1 7/8		A	N	122341
									GR	2 1/4	23 5/8	C		A		
16 3/8	23 5/8	2	FORD		VT	C	3	12	GR	2 3/4	23 7/8	C		A	N	124515
									GR	2 3/4	23 7/8	C		A		
16 3/8	24 3/16	1 1/4	WILLYS		VT	C	2	12	GR	2 13/16	24 5/8	1/2		A	N	124701
									GR	2 1/4	24	1/2		A		
16 3/8	24 3/16	2	WILLYS		VT	C	3	12	GR	2 13/16	24 5/8	C		A	N	124700
									GR	2 1/4	24	C		A		
16 1/2	14 1/16	2 1/4	JOHN DEERE		T	C	3	6	BL	5 3/4	16 3/4	1 3/8	20	A	C	223262
									BL	5 3/4	16 3/4	1 3/8	20	A		
16 1/2	14 3/8	2 15/16	JOHN DEERE	B	Z	C	4	7	BL	5 3/4	16 3/4	1 3/8	20	F	C	281563
									BL	5 3/4	16 3/4	1 3/8	20	F		
16 1/2	15 5/8	2 1/4	OLIVER HART PARR	DC4	X	C	3	7	GR	4 3/8	15 5/8	3/16		A	N	265992
									GR	2 1/4	15 5/8	C		A		
16 1/2	16 1/4	2 3/16	INT'L HARVESTER	B SERIES	Z	C	3	9	CR	6 5/8	17	5/16		A	N	225452
									CR	2 7/8	17 1/4	5/16		A		
16 1/2	16 5/16	2 1/4	INT'L HARVESTER	FARMALL B, SUPER A	T	C	3	7	CR	6 5/8	17	3/8		A	N	223177
									CR	2 7/8	17 1/4	3/8		A		
16 1/2	16 7/8	2 1/4	JEEP		T	C	3	11		2 3/8	17 1/2	C		0	N	260531
										2 3/8	17 1/2	C		0		
16 1/2	16 7/8	2 1/4	MINNEAPOLIS MOLINE		T	C	3	7	BL	4 1/8	19 1/8	C	20	F	C	260950
									BL	4 1/8	19 1/8	C	20	F		
16 1/2	17 1/16	2	INTERNATIONAL		VT	C	3	12	GR	2 1/4	17 1/2	C		A	N	122646
									GR	2 1/4	17 1/2	C		A		

Vista-Pro Automotive - Core Catalog
(Cores Sorted by Size)

Height	Width	Depth	Application	Description	Fin Type	Fin Matl	Rows	FPI	BH / TH Type	BH / TH Width	BH / TH Length	BH / TH OHF	BH / TH Bolts	BH / TH Shape	Hdr Support	Model #
16 1/2	17 7/16	3	LIFT TRUCKS & LOADERS	ALLIS CHALMERS	T	C	4	8	GR GR	3 3/8 3 3/8	17 7/8 17 7/8	C C		A A	N	278596
16 1/2	17 7/16	3 3/4	LIFT TRUCKS & LOADERS	TOWMOTOR V60	T	C	5	7		3 7/8 3 7/8	17 7/8 17 7/8	C C		0 0	N	279551
16 1/2	17 1/2	2 3/16	LIFT TRUCKS & LOADERS	MUSTANG	Z	C	3	10	GR GR	4 4	18 18	3/16 3/16		A A	N	286945
16 1/2	17 1/2	2 1/4	LIFT TRUCKS & LOADERS	INTERNATIONAL	X	C	3	9	GR GR	2 1/2 2 1/2	17 3/4 17 3/4	C C		A A	N	286786
16 1/2	17 1/2	3	LIFT TRUCKS & LOADERS	ALLIS CHALMERS	X	C	4	9	GR GR	3 3/8 3 3/8	17 7/8 17 7/8	5/16 5/16		A A	N	289882
16 1/2	17 5/8	2	JEEP		VT	C	3	12	GR GR	2 3/8 2 3/8	17 1/2 17 1/2	C C		A A	N	122595
16 1/2	18	2 1/4	FIAT ALLIS	D-15	T	C	3	8	GR GR	5 1/2 3	18 1/4 18 1/4	1/4 1/4		A A	N	223598
16 1/2	18 1/8	2	MERCEDES BENZ		VT	C	3	12	GR GR	2 3/16 2 3/16	18 18	C C		A A	N	128497
16 1/2	18 9/16	2 1/4	LIFT TRUCKS & LOADERS	INTERNATIONAL 3440	T	C	3	9	GR GR	2 1/2 2 1/2	19 19	C C		A A	N	223119
16 1/2	18 3/4	2 3/16	LIFT TRUCKS & LOADERS	INTERNATIONAL 3400 HI-LIFT	Z	C	3	10	GR GR	2 1/2 2 1/2	19 19	C C		A A	N	225402
16 1/2	19 3/8	1 1/4	MILLER ELECTRIC	PERKINS ENGINE	R	C	2	9	GR GR	3 1/4 2 1/4	19 5/8 19 5/8	1 1/4 C		A A	N	226626
16 1/2	20 3/8	2	MERCEDES BENZ		VT	C	3	12	FR FR	2 1/8 2 1/8	20 5/8 20 5/8	C C		A A	N	128551
16 1/2	20 7/8	1 1/4	MERCEDES BENZ		VT	C	2	14	GR GR	2 1/4 2 1/4	20 5/8 20 5/8	C C		A A	N	128632
16 1/2	20 7/8	2	MERCEDES BENZ		VT	C	3	12	GR GR	2 1/4 2 1/4	20 5/8 20 5/8	C C		A A	N	124802
16 1/2	22	1 1/4	JEEP		VT	C	2	14	GR GR	2 1/2 1 13/16	21 1/2 21 1/2	C C		A A	N	128345
16 1/2	22	1 1/4	ISUZU		VT	C	2	12	GR GR	1 7/8 1 7/8	21 7/8 21 7/8	C C		A A	N	128705
16 1/2	23 1/16	3	LIFT TRUCKS & LOADERS	HYSTER	T	C	4	9	GR GR	3 1/4 3 1/4	23 1/2 23 1/2	C C		A A	N	279553
16 1/2	23 1/8	2	MUSTANG		VT	C	3	14	GR GR	2 7/8 2 7/8	22 5/8 22 5/8	C C		A A	N	124905
16 1/2	23 9/16	1 9/16	MERCEDES BENZ		VE	C	3	17	GR GR	2 1/8 2 1/8	23 3/8 23 3/8	C C		A A	N	128222
16 1/2	23 5/8	1 1/4	MERCEDES-BENZ		VT	C	2	16	GR GR	2 1/8 2 1/8	23 3/8 23 3/8	C C		A A	N	124710
16 1/2	24 3/16	2	WILLYS		VT	C	3	12	GR BL	2 13/16 2 1/4	24 5/8 24 3/4	C C		A A	N	122546
16 9/16	16 7/8	2 3/16	MINNEAPOLIS MOLINE	ZA-JTU	Z	C	3	9	BL BL	4 1/8 4 1/8	19 1/8 19 1/8	1 1	20 20	F F	C	281479
16 9/16	19 13/16	2	MILLER ELECTRIC		VT	C	3	12	GR GR	3 1/8 2 3/8	19 5/8 19 5/8	15/16 C		A A	N	128590
16 5/8	10 7/16	1 1/4	MG		VT	C	2	12		2 2	11 11	C C		0 0	N	124856
16 5/8	10 7/16	2	MG		VT	C	3	12		2 1/8 2 1/8	11 11	C C		0 0	N	128111
16 5/8	16 7/8	2 1/4	MINNEAPOLIS MOLINE		T	C	3	8	BL BL	4 1/8 4 1/8	19 1/8 19 1/8	C C	20 20	F F	C	270950
16 5/8	17	3	LIFT TRUCKS & LOADERS	TOYOTA LIFT	B	C	4	6		3 3	17 1/4 17 1/4	C C		0 0	N	229654
16 5/8	18 1/8	3 3/4	CATERPILLAR	LIFT TRUCK	X	C	5	9		3 7/8 3 7/8	17 7/8 17 7/8	C C		0 0	N	266237
16 5/8	19 1/8	2 1/4	LIFT TRUCKS & LOADERS	YALE	T	C	3	8	GR GR	3 1/8 3 1/8	19 5/8 19 5/8	C C		A A	N	279554
16 5/8	19 3/8	2 3/16	LIFT TRUCKS & LOADERS	YALE	Z	C	3	9	GR GR	3 1/8 3 1/8	19 5/8 19 5/8	C C		A A	N	289050
16 5/8	19 3/8	2 15/16	LIFT TRUCKS & LOADERS	YALE	Z	C	4	9	FR FR	3 1/8 3 1/8	19 5/8 19 5/8	C C		A A	N	281664
16 5/8	19 11/16	2 1/4	MILLER ELECTRIC		T	C	3	8	GR GR	3 1/8 2 1/4	19 5/8 19 5/8	C C		A A	N	272731

Vista-Pro Automotive - Core Catalog
(Cores Sorted by Size)

Height	Width	Depth	Application	Description	Fin Type	Fin Matl	Rows	FPI	BH / TH Type	BH / TH Width	BH / TH Length	BH / TH OHF	BH / TH Bolts	BH / TH Shape	Hdr Support	Model #
16 5/8	19 13/16	1 1/4	MILLER WELDER		VT	C	2	12	GR GR	3 3/8 2 3/8	19 5/8 19 3/4	3/8 1/4		A A	N	128109
16 5/8	22	2	JEEP		VT	C	3	12		2 1/4 2 1/16	21 1/2 21 1/2	C C		0 0	N	128346
16 5/8	22	2	JEEP		VT	C	3	12	GR GR	2 1/2 2 1/4	21 1/2 21 1/2	C C		A A	N	128347
16 5/8	22	2	JEEP		VT	C	3	12	GR GR	2 1/2 2 1/2	21 5/8 21 5/8	C C		A A	N	128348
16 5/8	22 1/2	1 7/8	MB		X	C	2	11	GR GR	2 1/8 2 1/8	22 3/8 22 3/8	C C		A A	N	265097
16 5/8	23 5/8	1 1/4	MITSUBISHI		VT	C	2	15	GR GR	2 1/2 2 1/2	23 3/4 23 3/4	C C		A A	N	128837
16 5/8	24 3/4	2	MERCEDES BENZ		VT	C	3	12	GR GR	2 1/4 2 1/4	25 1/4 25 1/4	C C		A A	N	128714
16 5/8	25 7/8	2	MERCEDES BENZ		VT	C	3	14	GR GR	2 1/8 2 1/8	25 5/8 25 5/8	C C		A A	N	122682
16 5/8	25 7/8	2	MERCEDES BENZ		VT	C	3	14	GR GR	2 1/8 2 1/8	25 5/8 25 5/8	C C		A A	N	128179
16 11/16	18 1/8	2 3/8	INT'L HARVESTER	539563-R2, 539562-R2	S	C	4	9	FR FR	2 1/2 2 1/2	18 11/16 18 11/16	C C		0 0	N	229091
16 3/4	11 9/16	1 1/4	GM		VT	C	2	12	GR GR	2 3/4 2	13 3/16 13 3/16	C C		A A	N	124790
16 3/4	12 5/8	2	MAZDA		VT	C	3	12		2 1/2 2 1/2	12 1/2 12 1/2	C C		0 0	N	124708
16 3/4	13 3/4	2 3/16	FORD TRACTOR	DEXTER DIESEL BTM HDR OFFSET	Z	C	3	9	GR GR	2 1/2 2 1/2	14 1/4 16 1/4	C C		A A	N	225432
16 3/4	14 1/16	2 1/4	FORD TRACTOR	DEXTER DIESEL BTM HDR OFFSET	T	C	3	9	GR GR	2 1/2 2 1/2	14 1/4 16 1/4	C C		A A	N	223164
16 3/4	15 5/8	2 1/4	GALION	ROLLER	X	C	3	9	GR GR	6 2 1/2	15 1/2 15 1/2	1/4 C		A A	N	266325
16 3/4	17 7/16	3	INT'L HARVESTER	3414 DIESEL	T	C	4	6	GR GR	5 1/2 3 1/4	18 3/8 18 3/8	1/8 1/8		A A	N	279297
16 3/4	17 1/2	2 15/16	INT'L HARVESTER	BRITISH	Z	C	4	9	GR GR	5 1/2 3 1/4	18 1/4 18 1/2	1/4 1/4		A A	N	289176
16 3/4	18	3 3/4	LIFT TRUCKS & LOADERS	CLARK	T	C	5	8	GR GR	4 4	18 3/4 18 3/4	C C		A A	N	261284
16 3/4	18 11/16	1 1/4	VALIANT		VT	C	2	12	BU GR	4 1 3/4	19 1/4 18 1/2	C C		A A	N	122287
16 3/4	18 11/16	2	CHRYSLER		VT	C	3	12	BU FR	4 2 1/16	19 1/4 18 1/2	1/2 C		A A	N	122329
16 3/4	19 1/8	3	LIFT TRUCKS & LOADERS	ALLIS CHALMERS	T	C	4	8	GR GR	3 3/8 3 3/8	19 3/4 19 3/4	C C		A A	N	223121
16 3/4	19 1/8	3	MASSEY-FERGUSON	333	T	C	4	8	GR GR	6 3 1/2	19 1/2 19 1/2	1/2 1/2		A A	N	261598
16 3/4	19 1/4	1 1/4	VALIANT		VT	C	2	12	BU GR	4 1 3/4	19 1/4 19	C C		A A	N	122285
16 3/4	19 1/4	2	CHRYSLER		VT	C	3	12	BU FR	4 2 1/16	19 1/4 19	C C		A A	N	122357
16 3/4	19 3/8	1 7/8	LINCOLN ELECTRIC		X	C	2	7	GR GR	3 2 1/4	19 5/8 19 5/8	1/4 1/4		A A	N	281530
16 3/4	19 3/8	2 7/8	KUBOTA TRACTOR		R	C	5	10	GR GR	3 1/4 3 1/4	19 3/4 19 3/4	C C		A A	N	226560
16 3/4	19 11/16	1 1/2	LINCOLN ELECTRIC		T	C	2	8	GR GR	3 2 1/4	19 5/8 19 5/8	3/16 3/16		A A	N	272723
16 3/4	20 3/8	1 1/4	JEEP		VT	C	2	16	GR GR	2 3/8 2 3/8	20 20	C C		A A	N	128597
16 3/4	20 3/8	2 5/8	MERCEDES-BENZ		VT	C	4	12	GR GR	3 1/16 3 1/16	20 1/2 20 1/2	C C		A A	N	128321
16 3/4	20 5/8	1 9/16	TOYOTA		VE	C	3	16	GR GR	2 1/2 2 1/2	21 21	C C		A A	N	128787
16 3/4	20 7/8	1 1/4	TOYOTA		VT	C	2	12	GR GR	1 7/8 1 7/8	21 21	C C		A A	N	128708
16 3/4	21 1/16	1 9/16	TOYOTA		VE	C	3	16	GR GR	1 7/8 1 7/8	21 21	C C		A A	N	128797

Vista-Pro Automotive - Core Catalog
(Cores Sorted by Size)

Height	Width	Depth	Application	Description	Fin Type	Fin Matl	Rows	FPI	BH / TH Type	BH / TH Width	BH / TH Length	BH / TH OHF	BH / TH Bolts	BH / TH Shape	Hdr Support	Model #
16 3/4	21 7/16	1 1/4	GM		VT	C	2	14	BX BX	2 2	21 1/2 21 1/2	C C		A A	N	128307
16 3/4	22	2	CHRYSLER		VT	C	3	12	BU GR	4 2 7/8	22 1/4 21 3/4	7/16 C		A A	N	128630
16 3/4	22	2 5/8	MERCEDES BENZ		VT	C	4	12	GR GR	3 1/8 3 1/8	22 1/4 22 1/4	C C		A A	N	128351
16 3/4	23 1/8	1 1/4	GM		VT	C	2	14	BX BX	2 2	23 23	C C		A A	N	128308
16 3/4	23 1/8	2	MERCEDES BENZ		VT	C	3	12	GR GR	2 1/4 2 1/4	23 1/4 23 1/4	C C		A A	N	128177
16 3/4	25 7/8	1 1/4	MERCEDES-BENZ		VT	C	2	12	GR GR	2 2	25 3/4 25 3/4	C C		A A	N	128123
16 3/4	26 1/4	5 3/16	PETTIBONE	CRANE HERCULES ENGINE BRASS FINS	Z	B	7	9	GR GR	5 1/2 5 1/2	27 27	C C		A A	N	289173
16 3/4	26 7/16	5 1/4	PETTIBONE	HERCULES ENGINE	T	C	7	9	GR GR	5 1/2 5 1/2	27 27	C C		A A	N	223248
16 7/8	12 3/8	3	TRIUMPH		T	C	4	11	GR GR	3 1/4 3 1/4	12 3/4 12 3/4	C C		A A	N	260524
16 7/8	14 7/8	1 1/4	CHEVROLET		VT	C	2	12	GR GR	2 3/4 2 1/16	16 1/2 16 1/2	3/8 3/8		A A	N	124979
16 7/8	14 7/8	1 1/4	CHEVROLET	CHEVETTE	VT	C	2	12	GR GR	2 3/4 2 3/4	16 1/2 16 1/2	3/8 3/8		A A	N	124787
16 7/8	14 7/8	1 1/4	GM		VT	C	2	14	GR GR	2 3/8 2 3/8	16 1/2 16 1/2	3/8 3/8		A A	N	124987
16 7/8	14 7/8	2	CHEVROLET	CHEVETTE	VT	C	3	12	GR GR	2 3/4 2 3/4	16 1/2 16 1/2	C C		A A	N	124788
16 7/8	14 7/8	2	GM		VT	C	3	14	GR GR	2 3/8 2 3/8	16 1/2 16 1/2	C C		A A	N	128194
16 7/8	15 3/16	2 1/4	AUSTIN		T	C	3	10	GR GR	4 1/2 2 7/8	16 16	3/8 C		A A	N	264124
16 7/8	15 3/16	2 1/4	MASSEY-FERGUSON	81	T	C	3	6	GR GR	4 1/8 2 5/8	15 15	C C		A A	N	223249
16 7/8	15 1/4	1	CHEVROLET		VE	C	2	14	GR GR	2 3/8 2 3/8	16 1/2 16 1/2	C C		A A	N	128105
16 7/8	15 1/4	1 9/16	GM	J CAR	VE	C	3	14	GR GR	2 3/8 2 3/8	16 1/2 16 1/2	C C		A A	N	128133
16 7/8	15 5/8	2 3/16	CASE/INTERNATIONAL		Z	C	3	9	GR GR	5 7/8 2 1/2	15 3/4 15 3/4	3/16 3/16		A A	N	225317
16 7/8	15 5/8	2 1/4	CASE/INTERNATIONAL		X	C	3	6	GR GR	5 7/8 2 1/2	15 1/2 15 1/2	1/4 C		A A	N	265967
16 7/8	15 5/8	2 1/4	OLIVER HART PARR		X	C	3	8	GR GR	6 3/4 3	16 5/8 16 5/8	3/16 3/16		A A	N	288142
16 7/8	15 3/4	2 1/4	CASE/INTERNATIONAL		T	C	3	7	GR GR	5 7/8 2 1/2	15 3/4 15 3/4	3/16 3/16		A A	N	223010
16 7/8	16 5/16	2 1/4	OLIVER HART PARR		T	C	3	8	GR GR	6 3/4 3	16 5/8 16 5/8	3/16 3/16		A A	N	223263
16 7/8	16 7/8	2 3/16	JOHN DEERE	COMBINE	Z	C	3	7	GR GR	3 1/2 3 1/2	17 3/4 17 3/4	3/16 3/16		A A	N	281807
16 7/8	16 15/16	1 9/16	GM		VE	C	3	14	GR GR	2 3/8 2 3/8	18 5/8 18 5/8	C C		A A	N	122326
16 7/8	17 1/16	2	GM		VT	C	3	12	GR GR	2 3/8 2 3/8	18 5/8 18 5/8	C C		A A	N	128197
16 7/8	17 1/2	3	FIAT ALLIS		X	C	4	7	GR GR	3 7/8 3 7/8	17 7/8 17 7/8	1/8 1/8		A A	N	266233
16 7/8	18 1/8	4 7/16	LIFT TRUCKS & LOADERS	TOWMOTOR BRASS FINS	Z	B	6	9	GR GR	5 1/4 5 1/4	18 3/4 18 3/4	C C		A A	N	282665
16 7/8	18 1/8	2	MILLER WELDER		VT	C	3	12	GR GR	5 7/16 3	18 1/4 18 1/4	3/16 3/16		A A	N	124932
16 7/8	19 1/8	3	LIFT TRUCKS & LOADERS	CLARK 40B	T	C	4	8		3 1/8 3 1/8	19 3/4 19 3/4	C C		0 0	N	262968
16 7/8	19 3/8	2 3/16	LIFT TRUCKS & LOADERS	TOWMOTOR	Z	C	3	7	GR GR	4 4	19 3/4 19 3/4	3/16 3/16		A A	N	286907
16 7/8	20 5/8	2 7/8	CASE/INTERNATIONAL	450	S	C	5	8	GR GR	3 3/8 3 3/8	21 3/4 21 3/4	C C		A A	N	266234

Vista-Pro Automotive - Core Catalog
(Cores Sorted by Size)

Height	Width	Depth	Application	Description	Fin Type	Fin Matl	Rows	FPI	BH / TH Type	BH / TH Width	BH / TH Length	BH / TH OHF	BH / TH Bolts	BH / TH Shape	Hdr Support	Model #
16 7/8	21 1/4	2 1/4	CASE/INTERNATIONAL	450	X	C	3	8	GR GR	3 3/8 3 3/8	21 3/4 21 3/4	C C		A A	N	289087
16 7/8	22	1 1/4	WILLYS		VT	C	2	12	GR GR	2 1/4 2 1/4	21 3/4 21 3/4	3/16 3/16		A A	N	124517
16 7/8	22	1 1/4	CHRYSLER		VT	C	2	14	GR GR	3 3/8 2	21 5/8 21 3/4	FF FF		A A	N	124544
16 7/8	22	2	MERCEDES BENZ		VT	C	3	14	GR GR	2 1/4 2 1/4	22 1/8 22 1/8	C C		A A	N	124803
16 7/8	22	2	VALIANT		VT	C	3	12	GR GR	3 3/8 2 1/4	21 5/8 21 5/8	C C		A A	N	124771
16 7/8	22	2	WILLYS		VT	C	3	12	GR GR	2 1/4 2 1/4	21 3/4 21 3/4	C C		A A	N	128402
16 7/8	22	2	CHRYSLER		VT	C	3	12	GR GR	3 3/8 2 3/4	21 5/8 21 5/8	3/16 3/16		0 A	N	124546
16 7/8	23 5/8	1 1/4	AMC		VT	C	2	12	GR GR	2 13/16 1 3/4	24 5/8 24 5/8	C C		A A	N	124573
16 7/8	24 3/16	1 1/4	MATADOR		VT	C	2	16	GR GR	2 1/4 2 1/4	24 24	3/16 3/16		A A	N	124697
16 7/8	24 3/16	1 1/4	RAMBLER		VT	C	2	12	GR GR	2 13/16 1 3/4	24 5/8 24 5/8	3/16 C		A A	N	122317
16 7/8	24 3/16	1 1/4	RAMBLER		VT	C	2	14	GR GR	2 13/16 2 1/4	24 5/8 24	5/16 C		A A	N	122485
16 7/8	24 3/16	1 1/4	RAMBLER		VT	C	2	12	GR GR	2 13/16 1 3/4	24 5/8 24	5/8 C		A A	N	122532
16 7/8	24 3/16	1 1/4	RAMBLER		VT	C	2	16	GR GR	2 1/4 1 3/4	24 24	FF FF		A A	N	124784
16 7/8	24 3/16	1 1/4	AMC		VT	C	2	12	GR GR	2 13/16 2 1/4	24 5/8 24 3/4	5/16 C		A A	N	122487
16 7/8	24 3/16	1 1/4	AMC		VT	C	2	12	GR GR	2 1/4 2 1/4	24 1/4 24 1/4	C C		A A	N	128433
16 7/8	24 3/16	2	GREMLIN		VT	C	3	12	GR GR	2 1/4 2 1/4	24 24	C C		A A	N	124698
16 7/8	24 3/16	2	RAMBLER		VT	C	3	12	GR GR	2 13/16 2 1/4	24 5/8 24 5/8	3/16 C		A A	N	122481
16 7/8	24 3/16	2	RAMBLER		VT	C	3	12	GR GR	2 13/16 2 1/4	24 5/8 24	3/16 C		A A	N	122547
16 7/8	24 3/16	2	AMC		VT	C	3	12	GR GR	3 1/2 2 1/4	24 5/8 24 5/8	FF C		A A	N	122201
16 7/8	24 3/4	1 1/4	AMC		VT	C	2	12	GR GR	2 13/16 1 5/8	24 5/8 24 5/8	1/4 C		A A	N	128328
16 7/8	25 5/16	1 1/4	DATSUN		VT	C	2	12	GR GR	2 1/2 2 1/2	25 5/8 25 5/8	C C		A A	N	128154
17	13 1/2	3	JOHN DEERE	300 BACKHOE	T	C	4	8	GR GR	3 1/4 3 1/4	14 14	C C		A A	N	223185
17	13 3/4	2 1/4	JOHN DEERE	300	X	C	3	7	GR GR	3 1/4 3 1/4	14 14	C C		A A	N	221240
17	13 3/4	2 15/16	JOHN DEERE	300 BACKHOE	Z	C	4	9	GR GR	3 1/4 3 1/4	14 14	C C		A A	N	225507
17	14 3/8	1 3/4	JOHN DEERE	AT10299	S	C	3	9	GR GR	6 2 3/8	15 3/4 15 3/4	1/8 1/8		A A	N	229016
17	14 3/8	2 1/4	JOHN DEERE	M, MC, MT 40	X	C	3	8	GR FR	6 2 3/8	15 3/4 15 3/4	1/4 1/4		A A	N	266443
17	14 5/8	2 1/4	JOHN DEERE	420	T	C	3	7	GR FR	6 2 5/16	15 3/4 15 3/4	1/4 C		A A	N	223192
17	15	2 1/4	JOHN DEERE		X	C	3	9	GR GR	6 2 3/8	15 3/4 15 3/4	3/16 C		A A	N	287685
17	15 3/16	2 1/4	JOHN DEERE		T	C	3	7	GR GR	6 2 1/2	15 3/4 15 3/4	1/8 1/8		A A	N	223250
17	15 3/8	2	AUSTIN		VT	C	3	14	GR GR	4 1/2 2 7/8	16 16	1/4 1/4		A A	N	128336
17	16 1/4	2 15/16	OLIVER HART PARR	77	Z	C	4	7	GR FR	6 3/4 3 5/8	16 5/8 16 5/8	3/16 3/16		A A	N	281755
17	16 1/4	2 15/16	OLIVER HART PARR	77	Z	C	4	8	SQ SQ	6 3/4 3	16 5/8 16 5/8	3/16 3/16		A A	N	287217

Vista-Pro Automotive - Core Catalog
(Cores Sorted by Size)

Height	Width	Depth	Application	Description	Fin Type	Fin Matl	Rows	FPI	BH / TH Type	BH / TH Width	BH / TH Length	BH / TH OHF	BH / TH Bolts	BH / TH Shape	Hdr Support	Model #
17	16 5/16	3	OLIVER HART PARR		T	C	4	7	GR GR	6 3/4 3 5/8	16 5/8 16 5/8	1/8 1/8		A A	N	279855
17	16 7/8	2 3/16	OLIVER HART PARR		Z	C	3	9	GR GR	6 3/4 3	16 3/4 16 3/4	3/16 3/16		A A	N	280522
17	16 7/8	2 1/4	OLIVER HART PARR	77	T	C	3	8	GR GR	6 3/4 3	16 3/4 16 3/4	FF FF		A A	N	263802
17	17 1/16	2 5/8	JAGUAR		VT	C	4	12	GR GR	3 1/4 3 1/4	17 17	C C		0 0	N	128361
17	17 7/16	2 1/4	LIFT TRUCKS & LOADERS	ALLIS CHALMERS FTB34FS	T	C	3	8	GR GR	3 7/8 3 7/8	17 7/8 17 7/8	3/8 3/8		A A	N	223264
17	17 7/16	3	INT'L HARVESTER		T	C	4	6	GR GR	5 3/8 3 3/4	18 3/8 18 1/4	1/8 1/8		A A	N	279298
17	17 1/2	3	INT'L HARVESTER		X	C	4	11	GR GR	5 3/8 3 3/4	18 3/8 18 1/4	3/16 3/16		A A	N	286597
17	18 9/16	3	LIFT TRUCKS & LOADERS	CLARK ANGLED CRNRS FRONT	T	C	4	8	SH SH	3 1/4 3 1/4	20 20	1/4 1/4		SP SP	N	261403
17	18 11/16	1 1/4	VALIANT		VT	C	2	12	BU GR	4 1 3/4	19 1/4 18 1/2	C C		A A	N	122500
17	18 11/16	1 1/4	CHRYSLER		VT	C	2	14	GR GR	2 7/8 1 3/4	18 1/4 18 1/2	C C		A A	N	128409
17	18 3/4	3	LIFT TRUCKS & LOADERS	TOWMOTOR	X	C	4	8		3 3	19 3/4 19 3/4	C C		0 0	N	266096
17	19 1/8	2 1/4	FIAT ALLIS	FR-70	T	C	3	8	GR GR	4 4	19 7/8 19 7/8	1/8 1/8		A A	N	223134
17	19 1/8	3	LIFT TRUCKS & LOADERS	CLARK ANGLED CRNRS	T	C	4	8	SQ SQ	3 3	19 3/4 19 3/4	C C		SP SP	N	223221
17	19 1/8	3	LIFT TRUCKS & LOADERS	CLARK C30, C50, CF30	T	C	4	8	GR GR	3 3/8 3 3/8	20 20	C C		A A	N	223251
17	19 1/4	1 1/4	VALIANT		VT	C	2	12	BU GR	4 1 3/4	19 1/4 19	C C		A A	N	122425
17	19 1/4	2	TOYOTA		VT	C	3	12	GR GR	2 7/8 2 7/8	19 3/4 19 3/4	C C		A A	N	124809
17	19 3/8	1 7/8	FORD		X	C	2	6	SQ SQ	6 5/8 2 5/8	19 19	FF C		A A	N	265939
17	19 3/8	2 1/4	LIFT TRUCKS & LOADERS	CLARK LOADER	X	C	3	11		3 1/8 3 1/8	19 3/4 19 3/4	3/8 3/8		0 0	N	287356
17	19 3/8	2 15/16	LIFT TRUCKS & LOADERS	CLARK LOADER ANGLED CRNRS	Z	C	4	9	SH SH	3 1/16 3 1/16	19 3/4 19 3/4	C C		SP SP	N	225477
17	19 13/16	2 5/8	TOYOTA		VT	C	4	12	GR FR	2 7/8 2 3/4	19 5/8 19 5/8	C C		A A	N	128608
17	20 5/8	2 7/8	LIFT TRUCKS & LOADERS		S	C	5	9	GR GR	3 3/8 3 3/8	21 13/16 21 13/16	C C		A A	N	266127
17	20 13/16	3	CASE/INTERNATIONAL	450 CRAWLER	T	C	4	8	GR GR	3 3/8 3 3/8	21 3/4 21 3/4	C C		A A	N	223105
17	21 7/16	2	JEEP		VT	C	3	12		2 1/16 2 1/16	21 1/2 21 1/2	C C		0 0	N	128508
17	22	1 1/4	INTERNATIONAL		VT	C	2	12	GR GR	2 1/4 2 1/4	21 7/8 21 7/8	C C		A A	N	128522
17	22	2	CHRYSLER		VT	C	3	12	BU GR	4 2 7/8	22 1/4 21 3/4	FF FF		A A	N	124505
17	23 1/8	1 1/4	CHEVROLET		VT	C	2	12	GR GR	2 1/2 2	23 1/2 23 1/2	C C		A A	N	122380
17	23 1/8	2	GM		VT	C	3	12	GR GR	2 1/2 2 1/4	23 1/2 23 1/2	C C		A A	N	122486
17	24 3/16	3	LIFT TRUCKS & LOADERS	CLARK FVC60	T	C	4	8	GR GR	3 1/2 3 1/2	25 3/4 25 3/4	C C		A A	N	223222
17	24 3/8	3	LIFT TRUCKS & LOADERS	CLARK	X	C	4	9	GR GR	3 1/2 3 1/2	25 3/4 25 3/4	C C		A A	N	289629
17	25 5/16	1 1/4	CHEVROLET		VT	C	2	12	GR GR	2 1/2 2 1/2	25 7/16 25 7/16	C C		A A	N	128778
17	25 5/16	2	CHEVROLET		VT	C	3	12	GR GR	2 1/2 2 1/2	25 7/16 25 7/16	C C		A A	N	122360
17	25 5/16	2 5/8	GM		VT	C	4	12	GR GR	2 3/4 2 3/4	25 7/16 25 7/16	C C		A A	N	128403

Vista-Pro Automotive - Core Catalog
(Cores Sorted by Size)

Height	Width	Depth	Application	Description	Fin Type	Fin Matl	Rows	FPI	BH / TH Type	BH / TH Width	BH / TH Length	BH / TH OHF	BH / TH Bolts	BH / TH Shape	Hdr Support	Model #
17 1/8	12 3/8	3	TRIUMPH		T	C	4	9		3 3/8 3 3/8	12 7/8 12 7/8	C C		0 0	N	264250
17 1/8	13 1/2	2 1/4	JOHN DEERE		T	C	3	6	GR GR	3 3	13 3/4 13 3/4	C C		A A	N	278918
17 1/8	13 3/4	2 7/8	JOHN DEERE	1530	S	C	5	8	GR GR	3 3/16 3 3/16	14 14	1/4 1/4		A A	N	266210
17 1/8	13 3/4	3	JOHN DEERE	CORE OFFSET FLUSH ONE END	X	C	4	10		3 1/8 3 1/8	14 14	C C		0 0	N	266141
17 1/8	14 5/8	2 1/4	CATERPILLAR	TD-40	T	C	3	6	GR GR	5 7/8 2 3/8	15 3/4 15 3/4	1/4 C		A A	N	265624
17 1/8	18 1/8	2 15/16	CASE/INTERNATIONAL	350 LOADER R-42415	Z	C	4	7	GR GR	4 1/4 4 1/4	18 3/4 18 3/4	1/8 1/8		A A	N	225000
17 1/8	18 3/4	4 7/16	LIFT TRUCKS & LOADERS	TOWMOTOR BRASS FINS	Z	B	6	9	GR GR	5 1/4 5 1/4	18 7/8 18 7/8	C C		A A	N	286768
17 1/8	19 1/8	2 5/8	TOYOTA LIFT TRUCK		VT	C	4	12	GR GR	3 3	19 1/2 19 1/2	C C		A A	N	124874
17 1/8	19 3/8	3	LIFT TRUCKS & LOADERS	BAKER	X	C	4	6	GR GR	3 3/8 3 3/8	19 13/16 19 13/16	C C		A A	N	266205
17 1/8	19 13/16	2 5/8	TOYOTA		VT	C	4	12	GR FR	3 2 3/4	19 13/16 19 13/16	C C		A A	N	128439
17 1/8	22	1 1/4	VALIANT		VT	C	2	12	BU GR	4 2	22 1/4 21 3/4	C C		A A	N	122439
17 1/8	22	1 1/4	CHRYSLER		VT	C	2	12	BU GR	4 2	22 1/4 21 1/2	C C		A A	N	128620
17 1/8	22	2	CHRYSLER		VT	C	3	12	BU GR	4 2 1/4	22 1/4 21 7/8	C C		A A	N	122465
17 1/8	22 1/2	2 15/16	LIFT TRUCKS & LOADERS	HYSTER	Z	C	4	10	GR GR	3 1/2 3 1/2	23 3/4 23 3/4	C C		A A	N	289039
17 1/8	22 1/2	3	LIFT TRUCKS & LOADERS	HYSTER H100C	T	C	4	10	GR GR	3 1/2 3 1/2	23 3/4 23 3/4	C C		A A	N	265754
17 1/8	22 1/2	3	LIFT TRUCKS & LOADERS	HYSTER	T	C	4	9	GR GR	4 4	23 3/4 23 3/4	C C		A A	N	279564
17 1/4	8 3/4	2 3/8	TRUCK AND BUS HEATER	THOMAS, CARPENTER 10472	R	C	4	11	GR GR	2 1/2 2 1/2	9 9	C C		A A	N	226718
17 1/4	13 3/4	2 5/8	JOHN DEERE		VT	C	4	12	GR GR	3 3	13 3/4 13 3/4	C C		A A	N	124659
17 1/4	15	2 3/16	FORD TRACTOR	8N, 9N, 2N DIAMOND T/HDR	Z	C	3	7	SH FR	4 3/4 2 1/4	15 3/4 15 3/4	1 3/8 C		SP A	N	225434
17 1/4	15 3/16	2 1/4	MASSEY-FERGUSON	DIESEL DIAMOND T/HDR OUTLET BTM HDR	T	C	3	7	SH GR	4 3/4 2 13/16	15 5/8 15 11/16	C C		SP A	N	263125
17 1/4	15 3/16	2 1/4	MASSEY-FERGUSON	DIAMOND T/HDR OUTLET BTM HDR	T	C	3	8	SH GR	4 3/4 2 13/16	15 3/4 15 3/4	C C		SP A	N	275233
17 1/4	15 3/16	3	LIFT TRUCKS & LOADERS	HYSTER VT75	T	C	4	7	GR GR	7 3/4 3	15 15	1/4 1/4		A A	N	262150
17 1/4	15 3/8	2	AUSTIN		VT	C	3	12	GR GR	4 1/2 2 7/8	16 16	1/4 1/4		A A	N	128819
17 1/4	15 5/8	1 7/8	FORD TRACTOR	8N DIAMOND T/HDR	X	C	2	7	SH GR	4 3/4 2 1/4	15 3/4 15 3/4	1 5/16 C		SP A	N	221815
17 1/4	15 5/8	2 3/16	FORD TRACTOR	20, 30 DIAMOND T/HDR	Z	C	3	7	SH GR	4 1/4 2 3/8	15 3/4 15 3/4	C C		SP A	N	225440
17 1/4	15 5/8	2 3/16	FORD TRACTOR		Z	C	3	9	SH FR	7 1/2 2 1/4	15 3/4 15 3/4	1/4 C		SP A	N	225442
17 1/4	15 5/8	2 1/4	FORD TRACTOR	DIAMOND T/HDR	X	C	3	8	SH FR	4 1/4 2 3/8	15 3/4 15 3/4	C C		SP A	N	221503
17 1/4	15 5/8	2 1/4	FORD TRACTOR	DIAMOND T/HDR	X	C	3	9	SH FR	4 1/4 2 3/8	15 3/4 15 3/4	C C		SP A	N	221809
17 1/4	15 3/4	1 1/2	FORD TRACTOR	8N DIAMOND T/HDR	T	C	2	7	SH GR	4 3/4 2 1/4	15 3/4 15 3/4	C C		SP A	N	223131
17 1/4	15 3/4	2 1/4	CASE/INTERNATIONAL	500	T	C	3	8	GR GR	6 2 1/2	15 3/4 15 3/4	1/8 C		A A	N	223012
17 1/4	15 3/4	2 1/4	FORD TRACTOR	20, 30 DIAMOND T/HDR	T	C	3	6	SH GR	4 1/8 2 3/8	15 3/4 15 3/4	C C		SP A	N	223138
17 1/4	15 3/4	2 1/4	FORD TRACTOR		T	C	3	7	SH FR	7 1/2 2 1/4	15 3/4 15 3/4	1/8 C		SP A	N	223142

Vista-Pro Automotive - Core Catalog
(Cores Sorted by Size)

Height	Width	Depth	Application	Description	Fin Type	Fin Matl	Rows	FPI	BH / TH Type	BH / TH Width	BH / TH Length	BH / TH OHF	BH / TH Bolts	BH / TH Shape	Hdr Support	Model #
17 1/4	15 3/4	2 1/4	FORD TRACTOR	2N, 8N, 9N DIAMOND T/HDR	T	C	3	6	SH FR	4 3/4 2 5/16	15 3/4 15 3/4	C C		SP A	N	223157
17 1/4	17 7/16	2 1/4	LIFT TRUCKS & LOADERS	ALLIS CHALMERS	T	C	3	8	GR GR	3 7/8 3 7/8	17 7/8 17 7/8	3/8 1/4		A A	N	278599
17 1/4	17 5/8	2 5/8	JAGUAR		VT	C	4	12	GR GR	3 3	17 1/4 17 1/4	C C		A A	N	124182
17 1/4	18	2 1/4	JOHN DEERE	2010 DIESEL	T	C	3	7	GR GR	3 1/4 3 1/4	18 3/8 18 3/8	C C		A A	N	223193
17 1/4	18	2 1/4	JOHN DEERE	1020	T	C	3	8	GR GR	3 1/4 3 1/4	18 3/8 18 3/8	C C		A A	N	264355
17 1/4	18 1/8	2 3/16	JOHN DEERE	1020	Z	C	3	9	GR GR	3 1/4 3 1/4	18 3/8 18 3/8	C C		A A	N	225461
17 1/4	18 1/8	2	JOHN DEERE		VT	C	3	12	GR GR	3 1/4 3 1/4	18 3/8 18 3/8	C C		A A	N	124883
17 1/4	18 9/16	3	LIFT TRUCKS & LOADERS	TOWMOTOR	T	C	4	8	GR GR	4 1/8 4 1/8	18 7/8 18 7/8	C C		A A	N	270667
17 1/4	18 11/16	2	MERCEDES-BENZ		VT	C	3	12	GR GR	2 1/4 2 1/4	18 1/2 21 1/2	C C		A A	N	128322
17 1/4	19 1/8	3	JAGUAR		T	C	4	11		3 3	19 1/2 19 1/2	C C		0 0	N	263616
17 1/4	19 1/4	2	TOYOTA		VT	C	3	12	GR GR	3 3	19 7/8 19 7/8	C C		A A	N	122279
17 1/4	19 3/8	1 7/8	DETROIT DIESEL	2-71 PUMP	X	C	2	9	GR GR	3 3/8 3 3/8	19 3/4 19 3/4	3/16 3/16		A A	N	286528
17 1/4	19 11/16	3	HUBER		T	C	4	6	GR GR	5 3 3/8	20 20	3/16 3/16		A A	N	261102
17 1/4	19 13/16	2 5/8	JAGUAR		VT	C	4	16	GR GR	3 1/8 3 1/8	19 3/8 19 3/8	C C		A A	N	128363
17 1/4	19 13/16	2 5/8	JAGUAR		VT	C	4	12	GR GR	3 3	19 1/2 19 1/2	C C		A A	N	128362
17 1/4	22	1 1/4	VALIANT		VT	C	2	14	BU GR	4 2	22 1/4 21 3/4	3/16 3/16		A A	N	124637
17 1/4	22	2	FORD		VT	C	3	12	BU GR	4 1/8 2 9/16	23 22	C C		A A	N	122226
17 1/4	22 1/2	3	LIFT TRUCKS & LOADERS	HYSTER	T	C	4	8	GR GR	3 1/2 3 1/2	23 3/4 23 3/4	C C		A A	N	276912
17 5/16	15 5/8	2 3/8	FORD TRACTOR	L450 SKIDDER 9619994	S	C	4	9	GR GR	2 5/8 2 5/8	15 11/16 15 11/16	C C		A A	N	229047
17 3/8	15 3/8	2 5/8	JOHN DEERE		VT	C	4	12	GR GR	3 1/8 3 1/8	15 3/16 15 3/16	C C		A A	N	122714
17 3/8	15 3/4	2 1/4	MASSEY-FERGUSON	MODEL 30	T	C	3	8	GR GR	5 15/16 2 3/8	15 7/8 15 7/8	7/8 C		A A	N	223265
17 3/8	15 3/4	2 1/4	MASSEY-FERGUSON	101 JUNIOR	T	C	3	8	GR GR	5 15/16 2 3/8	15 7/8 15 7/8	1 1/2 C		A A	N	270271
17 3/8	16 5/16	2 1/4	TRIUMPH		T	C	3	11	GR GR	2 1/2 2 1/2	17 17	C C		A A	N	265415
17 3/8	17 1/16	1 1/4	FORD		VT	C	2	12	BU GR	3 1/8 1 5/8	17 3/8 16 3/4	C C		A A	N	122351
17 3/8	17 1/16	1 1/4	FORD		VT	C	2	12	BU GR	3 1/8 1 5/8	17 3/8 16 3/4	C C		A A	N	122374
17 3/8	17 1/16	1 1/4	FORD		VT	C	2	12	BU GR	3 1/8 1 5/8	17 3/8 16 7/8	C C		A A	N	122392
17 3/8	17 1/16	2	FORD		VT	C	3	12	BU GR	3 1/8 2 1/4	17 3/8 16 7/8	C C		A A	N	122321
17 3/8	17 1/16	2 5/8	JAGUAR		VT	C	4	14	BX BX	2 5/8 2 5/8	16 7/8 16 7/8	C C		A A	N	128822
17 3/8	17 7/16	3	LIFT TRUCKS & LOADERS	CLARK	T	C	4	8	GR GR	3 1/4 3 1/4	17 7/8 17 7/8	C C		A A	N	279568
17 3/8	17 1/2	2 15/16	LIFT TRUCKS & LOADERS	CLARK	Z	C	4	9	GR GR	3 1/4 3 1/4	17 7/8 17 7/8	C C		A A	N	289896
17 3/8	17 5/8	2	FORD		VT	C	3	12	GR GR	2 5/8 2 5/8	17 1/2 17 1/2	C C		A A	N	124644
17 3/8	18 9/16	3	ROVER		T	C	4	11	GR GR	4 1/8 3 1/4	18 7/8 18 7/8	C C		A A	N	264337

Vista-Pro Automotive - Core Catalog
(Cores Sorted by Size)

Height	Width	Depth	Application	Description	Fin Type	Fin Matl	Rows	FPI	BH / TH Type	BH / TH Width	BH / TH Length	BH / TH OHF	BH / TH Bolts	BH / TH Shape	Hdr Support	Model #
17 3/8	18 11/16	1 1/4	CHEVROLET		VT	C	2	12	GR	2 1/4	18 1/2	3/8		A	N	122462
									GR	2 1/4	18 1/2	3/8		A		
17 3/8	18 11/16	1 1/4	PLYMOUTH		VT	C	2	12	GR	2 7/8	18 1/4	1/8		A	N	124507
									GR	1 3/4	18 1/2	C		A		
17 3/8	18 11/16	2	CHEVROLET		VT	C	3	12	GR	2 1/4	18 1/2	C		A	N	122401
									GR	2 1/4	18 1/2	C		A		
17 3/8	18 11/16	2	CHRYSLER		VT	C	3	12	GR	2 7/8	18 1/4	C		A	N	128628
									GR	2 1/8	18 1/2	C		A		
17 3/8	19 1/4	2	CHEVROLET		VT	C	3	12	GR	2 1/2	19 3/8	C		A	N	122557
									GR	2 1/2	19 3/8	C		A		
17 3/8	20 3/8	1 1/4	FORD		VT	C	2	12	BU	3 3/16	20 7/16	C		A	N	122429
									GR	1 5/8	19 13/16	C		A		
17 3/8	20 3/8	1 1/4	FORD		VT	C	2	12	BU	3 3/16	20 7/16	C		A	N	122475
									GR	1 5/8	19 13/16	C		A		
17 3/8	20 3/8	1 1/4	FORD		VT	C	2	12	BU	3 3/16	20 7/16	C		A	N	122590
									GR	1 5/8	19 13/16	C		A		
17 3/8	20 3/8	1 1/4	FORD		VT	C	2	12	BU	3 3/16	20 7/16	C		A	N	122442
									GR	1 5/8	19 13/16	C		A		
17 3/8	20 3/8	1 1/4	FORD		VT	C	2	12	BU	3 3/16	20 7/16	C		A	N	122477
									GR	1 5/8	19 13/16	C		A		
17 3/8	20 3/8	1 1/4	FORD		VT	C	2	12	BU	3 3/16	20 7/16	C		A	N	124763
									GR	1 5/8	19 13/16	C		A		
17 3/8	20 3/8	1 1/4	FORD		VT	C	2	12	BU	3 3/16	20 7/16	C		A	N	128610
									GR	1 5/8	19 13/16	C		A		
17 3/8	20 3/8	2	FORD		VT	C	3	12	BU	3 3/16	20 7/16	C		A	N	122597
									GR	2 5/16	19 7/8	C		A		
17 3/8	20 3/8	2	FORD		VT	C	3	16	BU	3 3/16	20 7/16	C		A	N	122605
									FR	2	19 13/16	C		A		
17 3/8	20 3/8	2	FORD		VT	C	3	12	BU	3 3/16	20 7/16	C		A	N	128614
									FR	2 1/8	19 13/16	C		A		
17 3/8	20 3/8	2 5/8	FORD		VT	C	4	12	GR	3 1/8	20 1/2	C		A	N	128506
									GR	3 1/8	20 1/2	C		A		
17 3/8	23 1/8	1 1/4	CHEVROLET		VT	C	2	12	GR	2 1/2	23 1/2	3/8		A	N	122569
									GR	2	23 1/2	C		A		
17 3/8	23 1/8	1 1/4	FORD		VT	C	2	12	BU	3 3/16	23 1/2	C		A	N	122427
									GR	1 5/8	22 3/4	C		A		
17 3/8	23 1/8	1 1/4	FORD		VT	C	2	12	GR	2 1/2	22 3/4	3/8		A	N	122536
									GR	1 5/8	22 3/4	C		A		
17 3/8	23 1/8	1 1/4	FORD		VT	C	2	12	GR	2 9/16	22 7/8	C		A	N	128611
									GR	2 9/16	22 7/8	C		A		
17 3/8	23 1/8	1 1/4	FORD		VT	C	2	12	BU	3 3/16	23 1/2	C		A	N	122454
									GR	1 5/8	22 3/4	C		A		
17 3/8	23 1/8	1 1/4	FORD		VT	C	2	12	BU	3 3/16	23 1/2	C		A	N	122591
									GR	1 5/8	22 3/4	C		A		
17 3/8	23 1/8	2	CHEVROLET		VT	C	3	13	GR	2 3/4	25 7/16	C		A	N	122556
									GR	2 3/4	25 7/16	C		A		
17 3/8	23 1/8	2	FORD		VT	C	3	12	BU	3 3/16	23 7/16	C		A	N	122428
									GR	2 1/2	22 7/8	C		A		
17 3/8	23 1/8	2	FORD		VT	C	3	14	GR	2 7/8	22 11/16	C		A	N	124745
									GR	2 7/8	22 11/16	C		A		
17 3/8	23 1/8	2	FORD		VT	C	3	12	BU	3 3/16	23 1/2	C		A	N	122393
									GR	2 1/4	23	C		A		
17 3/8	23 1/8	2	FORD		VT	C	3	12	GR	2 1/2	22 7/8	C		A	N	122518
									GR	2 1/2	22 7/8	C		A		
17 3/8	23 1/8	2	FORD		VT	C	3	12	BU	3 3/16	23 1/2	C		A	N	122593
									GR	2 1/2	22 7/8	C		A		
17 3/8	23 1/8	2	GM		VT	C	3	12	GR	2 1/2	23 1/2	C		A	N	122594
									GR	2 1/4	23 1/2	C		A		
17 3/8	23 1/8	2	FORD		VT	C	3	12	GR	2 1/2	22 7/8	C		A	N	128343
									FR	2 1/16	22 7/8	C		A		
17 3/8	23 1/8	2	FORD		VT	C	3	12	BU	3 3/16	23 1/2	C		A	N	128615
									FR	2 1/8	22 7/8	C		A		
17 3/8	24 3/16	1 1/4	FORD	FAIRLANE	VT	C	2	12	GR	2 3/4	23 7/8	3/16		A	N	122587
									GR	2 3/4	23 7/8	3/16		A		

Vista-Pro Automotive - Core Catalog
(Cores Sorted by Size)

Height	Width	Depth	Application	Description	Fin Type	Fin Matl	Rows	FPI	BH / TH Type	BH / TH Width	BH / TH Length	BH / TH OHF	BH / TH Bolts	BH / TH Shape	Hdr Support	Model #
17 3/8	24 3/16	2	FORD	FAIRLANE	VT	C	3	12	GR GR	2 3/4 2 3/4	23 7/8 23 7/8	C C		A A	N	122598
17 3/8	25 5/16	1 1/4	CADILLAC		VT	C	2	12	GR GR	3 2 3/4	25 7/16 25 7/16	C C		A A	N	122450
17 3/8	25 5/16	2	GM	Reg. plant model	VT	C	3	12	GR GR	3 2 3/4	25 7/16 25 7/16	3/8 C		A A	N	122356
17 3/8	25 5/16	2	GM		VT	C	3	12	GR GR	2 3/4 2 3/4	25 7/16 25 7/16	C C		A A	N	122405
17 3/8	25 5/16	2	GM		VT	C	3	12	GR GR	3 2 1/2	25 7/16 25 7/16	3/8 C		A A	N	128207
17 3/8	25 5/16	2 5/8	GM		VT	C	4	12	GR GR	3 2 7/8	25 7/16 25 7/16	C C		A A	N	122378
17 3/8	25 5/16	2 5/8	OLDSMOBILE		VT	C	4	12	GR GR	3 3/8 3 3/8	25 7/16 25 7/16	C C		A A	N	122390
17 3/8	25 5/16	2 5/8	GM		VT	C	4	12	GR GR	2 3/4 2 3/4	25 7/16 25 7/16	C C		A A	N	128333
17 1/2	15 5/8	2 3/16	MASSEY-FERGUSON	101 JUNIOR	Z	C	3	7	GR GR	6 2 1/2	15 7/8 15 7/8	1 3/16		A A	N	280144
17 1/2	16 1/4	2 3/16	FORD TRACTOR	NAA600, 700, 800, 900 BKT T/HDR	Z	C	3	7	BU GR	5 7/8 2 3/8	17 16 1/2	1/2 1/8		A A	N	225443
17 1/2	16 1/4	2 3/16	OLIVER HART PARR	70	Z	C	3	8	SQ SQ	6 3/4 3 1/8	16 5/8 16 5/8	11/16 11/16		A A	N	281150
17 1/2	16 1/4	2 1/4	FORD TRACTOR	NAA-NAB-600-800,800SD BKT T/HDR	X	C	3	8	BU GR	5 7/8 2 3/8	17 16 1/2	7/16 C		A A	N	288402
17 1/2	16 1/4	2 1/4	OLIVER HART PARR	70	X	C	3	7	GR GR	6 3/4 3 1/4	16 5/8 16 5/8	3/16 3/16		A A	N	281753
17 1/2	16 1/4	2 15/16	FORD POWER PRODUCTS	STATIONARY	Z	C	4	7	GR GR	3 3/8 3 3/8	16 1/2 16 1/2	C C		A A	N	287512
17 1/2	16 1/4	3	FORD POWER PRODUCTS		X	C	4	6	GR GR	3 3/8 3 3/8	16 1/2 16 1/2	C C		A A	N	288000
17 1/2	16 1/4	3	FORD TRACTOR	TRACTOR	X	C	4	6	GR GR	3 3/8 3 3/8	16 1/2 16 1/2	C C		A A	N	266070
17 1/2	16 1/4	3	INT'L HARVESTER	424 DIESEL	X	C	4	9	GR GR	6 1/4 3 1/4	16 1/4 16 1/4	1/4 C		A A	N	266242
17 1/2	16 1/4	3	INT'L HARVESTER	2424	X	C	4	11	GR GR	6 3/8 3 1/4	16 3/8 16 3/8	3/16 3/16		A A	N	289376
17 1/2	16 5/16	2 1/4	FORD POWER PRODUCTS	STATIONARY	T	C	3	6	GR GR	3 3/8 3 3/8	16 1/2 16 1/2	C C		A A	N	265503
17 1/2	16 5/16	2 1/4	FORD TRACTOR	NAA, NAB, JUBILEE BKT T/HDR	T	C	3	7	BU FR	5 7/8 2 3/8	17 16 1/2	1/4 C		A A	N	223144
17 1/2	16 5/16	2 1/4	INT'L HARVESTER		T	C	3	10	GR GR	6 3 1/4	16 1/2 16 1/2	3/16 3/16		A A	N	279299
17 1/2	16 5/16	2 1/4	OLIVER HART PARR	70	T	C	3	7	GR GR	6 3/4 3 1/8	16 5/8 16 5/8	1/4 1/4		A A	N	223252
17 1/2	16 5/16	2 1/4	OLIVER HART PARR	55 SUPER	T	C	3	8	GR GR	6 3/4 2 1/2	16 5/8 16 5/8	1/8 1/8		A A	N	271390
17 1/2	16 5/16	3	INT'L HARVESTER	424 DIESEL	T	C	4	7	GR GR	6 3/8 3 3/8	16 1/4 16 1/4	3/16 3/16		A A	N	276741
17 1/2	16 5/16	3	LIFT TRUCKS & LOADERS	TOWMOTOR	T	C	4	6	GR GR	3 1/2 3 1/2	16 1/2 16 1/2	1/8 1/8		A A	N	279573
17 1/2	17 1/16	2	INTERNATIONAL		VT	C	3	12	GR GR	2 3/4 2 3/4	16 5/8 16 5/8	C C		A A	N	122586
17 1/2	18	2 1/4	MASSEY-FERGUSON		T	C	3	9	GR GR	4 2 1/2	18 1/4 18 1/4	1/2 C		A A	N	272725
17 1/2	18	3 3/4	LIFT TRUCKS & LOADERS	HYSTER	T	C	5	8		3 7/8 3 7/8	18 1/4 18 1/4	C C		0 0	N	279569
17 1/2	18 1/8	2 1/4	CASE/INTERNATIONAL		X	C	3	7	GR FR	5 2 1/4	18 3/8 18 3/8	1/8 C		A A	N	266425
17 1/2	18 1/8	2 15/16	JOHN DEERE	10-20, 12-20	Z	C	4	9	BL BL	5 3/4 5 3/4	20 1/2 20 1/2	1 1/4 1 1/4	22 22	B B	C	281445
17 1/2	18 1/8	3 3/4	LIFT TRUCKS & LOADERS	HYSTER	X	C	5	8	GR GR	3 7/8 3 7/8	18 1/4 18 1/4	C C		A A	N	286635

Vista-Pro Automotive - Core Catalog
(Cores Sorted by Size)

Height	Width	Depth	Application	Description	Fin Type	Fin Matl	Rows	FPI	BH / TH Type	BH / TH Width	BH / TH Length	BH / TH OHF	BH / TH Bolts	BH / TH Shape	Hdr Support	Model #
17 1/2	18 11/16	1 1/4	VALIANT		VT	C	2	12	BU GR	4 1 3/4	19 1/4 18 1/2	FF FF		A A	N	122553
17 1/2	18 11/16	2 5/8	MERCEDES-BENZ		VT	C	4	12	GR GR	2 7/8 2 7/8	18 1/2 18 1/2	C C		A A	N	128323
17 1/2	18 3/4	2 1/4	JOHN DEERE		X	C	3	7	BL BL	5 3/4 5 3/4	20 1/2 20 1/2	1 1/2 1 1/2	22 22	B B	C	260111
17 1/2	19 1/4	1 1/4	CHRYSLER		VT	C	2	12	BU GR	4 1 3/4	19 1/4 19	FF FF		A A	N	122554
17 1/2	22	1 1/4	CHRYSLER		VT	C	2	12	BU GR	4 2	22 1/4 21 3/4	FR FR		A A	N	122563
17 1/2	22	1 1/4	CHRYSLER		VT	C	2	12	GR GR	3 3/8 2	21 5/8 21 3/4	1/4 1/4		A A	N	124582
17 1/2	22	1 1/4	CHRYSLER		VT	C	2	14	BU GR	4 2	22 1/4 21 5/8	FR FR		A A	N	128319
17 1/2	22	2	CHRYSLER		VT	C	3	12	BU GR	4 2 1/4	22 1/4 21 3/4	FR FR		A A	N	122581
17 1/2	22	2	CHRYSLER		VT	C	3	12	BU GR	4 2 1/2	22 1/4 22	C C		A A	N	122574
17 1/2	22	2	CHRYSLER		VT	C	3	12	BU GR	4 2 11/16	22 1/4 21 9/16	C C		A A	N	128626
17 1/2	22	2	CHRYSLER		VT	C	3	12	GR GR	3 3/8 2 1/8	21 5/8 21 5/8	3/16 C		A A	N	128627
17 1/2	24 3/16	2 5/8	MERCEDES BENZ		VT	C	4	12	GR GR	3 1/2 3 1/2	24 1/2 24 1/2	C C		A A	N	128715
17 1/2	25 5/16	2 1/4	STUDEBAKER		T	C	3	8	CR CR	5 1/2 3 3/4	25 1/2 25 1/2	1/2 1/2		A A	N	260281
17 1/2	25 7/8	1 1/4	CHRYSLER		VT	C	2	14	GR GR	3 2	25 9/16 25 9/16	3/8 3/8		A A	N	122564
17 1/2	25 7/8	1 1/4	PLYMOUTH		VT	C	2	12	GR GR	3 2 3/4	25 9/16 25 9/16	3/8 3/8		A A	N	122522
17 1/2	25 7/8	1 1/4	CHRYSLER		VT	C	2	12	GR GR	3 2 5/16	25 9/16 25 9/16	C C		A A	N	128623
17 1/2	25 7/8	2	CHRYSLER		VT	C	3	14	GR GR	3 2 3/4	25 9/16 25 9/16	C C		A A	N	122491
17 1/2	25 7/8	2	CHRYSLER		VT	C	3	12	GR FR	3 2 1/8	25 9/16 25 9/16	1/4 C		A A	N	128621
17 1/2	25 7/8	2	CHRYSLER		VT	C	3	12	GR GR	3 2 1/4	25 9/16 25 9/16	1/4 C		A A	N	124538
17 1/2	25 7/8	2 5/8	CHRYSLER		VT	C	4	12	GR FR	3 2 7/8	25 9/16 25 5/8	C C		A A	N	122493
17 1/2	28 1/16	1 1/4	INTERNATIONAL		VT	C	2	12	GR GR	2 1/2 2 1/2	28 1/8 28 1/8	1/4 1/4		A A	N	124600
17 1/2	28 1/16	1 1/4	INTERNATIONAL		VT	C	2	12	GR GR	2 1/2 2 1/2	28 1/8 28 1/8	C C		A A	N	124599
17 1/2	28 1/16	2	INTERNATIONAL		VT	C	3	12	GR GR	2 1/2 2 1/2	28 1/8 28 1/8	1/4 1/4		A A	N	124888
17 5/8	16 1/2	1 1/4	VOLVO		VT	C	2	12	GR GR	2 7/16 2 7/16	17 5/16 17 5/16	C C		A A	N	124684
17 5/8	16 1/2	2	VOLVO		VT	C	3	12	GR GR	2 7/16 2 7/16	17 5/16 17 5/16	C C		A A	N	124715
17 5/8	16 7/8	2 1/4	LIFT TRUCKS & LOADERS	TCM LIFT	X	C	3	11	GR GR	3 3	17 1/4 17 1/4	C C		A A	N	221794
17 5/8	16 7/8	2 3/8	TOYOTA LIFT TRUCK		R	C	4	10	GR GR	3 3	17 1/4 17 1/4	C C		A A	N	225689
17 5/8	17	3	LIFT TRUCKS & LOADERS	TOYOTA LIFT	B	B	4	6	FR FR	3 3	17 1/4 17 1/4	C C		0 0	N	229651
17 5/8	17 1/16	1 1/4	INT HARV TRK		VT	C	2	12	GR GR	2 13/16 2 13/16	16 3/4 16 3/4	1/4 1/4		A A	N	122649
17 5/8	17 1/16	1 1/4	INTERNATIONAL		VT	C	2	14	GR GR	2 3/4 2 3/4	16 3/4 16 3/4	1/4 1/4		A A	N	122473
17 5/8	17 1/16	1 1/4	INTERNATIONAL		VT	C	2	12	GR GR	2 7/8 2 7/8	16 3/4 17	1/4 1/4		A A	N	124598
17 5/8	17 1/16	2	INTERNATIONAL		VT	C	3	12	GR GR	2 7/8 2 7/8	16 3/4 16 3/4	C C		A A	N	128815

Vista-Pro Automotive - Core Catalog
(Cores Sorted by Size)

Height	Width	Depth	Application	Description	Fin Type	Fin Matl	Rows	FPI	BH / TH Type	BH / TH Width	BH / TH Length	BH / TH OHF	BH / TH Bolts	BH / TH Shape	Hdr Support	Model #
17 5/8	17 7/16	2 1/4	FORD TRACTOR		T	C	3	7	GR GR	4 2 7/8	17 3/4 17 3/4	1/2 1/2		A A	N	223179
17 5/8	17 7/16	2 1/4	FORD TRACTOR	5000 DIESEL	T	C	3	7	GR GR	3 7/8 2 7/8	18 18	1/8 C		A A	N	223186
17 5/8	17 1/2	2 1/4	FORD TRACTOR	5000 DIESEL	X	C	3	10	GR GR	4 2 7/8	17 3/4 17 3/4	1 3/8 C		A A	N	221785
17 5/8	17 1/2	3	FORD TRACTOR	5000 DIESEL	X	C	4	10	GR SQ	4 2 7/8	17 3/4 17 3/4	C C		A A	N	281827
17 5/8	18	2 1/4	CASE/INTERNATIONAL	541, W5G	T	C	3	9	GR GR	5 2 5/8	18 3/8 18 3/8	1/4 1/4		A A	N	223106
17 5/8	18 1/8	2 3/16	CASE/INTERNATIONAL	541	Z	C	3	10	GR GR	5 2 5/8	18 3/8 18 3/8	3/16 3/16		A A	N	225320
17 5/8	18 1/8	2 1/4	MASSEY-FERGUSON	40B	X	C	3	8	GR GR	4 2 1/2	18 3/8 18 3/8	1 1/4 C		A A	N	281828
17 5/8	20 3/8	2	CHRYSLER		VT	C	3	12	GR GR	2 1/2 2 1/2	20 1/2 20 1/2	C C		A A	N	128314
17 5/8	20 5/8	3	LIFT TRUCKS & LOADERS	TOYOTA LIFT	X	C	4	6	GR GR	4 1/8 4 1/8	21 21	C C		A A	N	281868
17 5/8	21 15/16	2 1/4	INTERNATIONAL		T	C	3	8	GR GR	3 1/2 2 1/2	22 3/8 22 3/8	1/4 1/4		A A	N	260860
17 5/8	22	1 1/4	CHRYSLER		VT	C	2	14	BU GR	4 2	22 1/4 21 3/4	C C		A A	N	122239
17 5/8	24 3/16	1 1/4	INTERNATIONAL		VT	C	2	12	GR GR	2 13/16 1 3/4	24 5/8 24	5/16 C		A A	N	124601
17 5/8	24 3/16	2	INTERNATIONAL		VT	C	3	12	GR GR	2 3/4 2 1/4	24 3/4 24	C C		A A	N	124656
17 5/8	25 5/16	2	GM		VT	C	3	12	GR GR	2 3/4 2 3/4	25 7/16 25 7/16	C C		A A	N	122286
17 11/16	17 5/8	2	VOLVO		VT	C	3	14	GR GR	2 7/16 2 7/16	17 5/16 17 5/16	C C		A A	N	128395
17 11/16	23 3/4	2 3/8	JOHN DEERE	210C BACKHOE AT118639	S	C	4	7	GR GR	4 1/2 4 1/2	23 15/16 23 15/16	C C		A A	N	229027
17 3/4	14 3/8	2 1/4	JOHN DEERE		X	C	3	8	BL BL	5 9/16 5 9/16	16 16	1 3/8 1 3/8	18 18	A A	C	280081
17 3/4	14 3/8	2 3/8	JOHN DEERE	B50 AB466R	S	C	4	7	BL BL	5 9/16 5 9/16	16 16	C C	18 18	A A	C	229006
17 3/4	14 3/8	2 15/16	JOHN DEERE	B50	Z	C	4	9	BL BL	5 9/16 5 9/16	16 16	1 3/8 1 3/8	18 18	A A	C	225463
17 3/4	14 3/8	3 7/16	JOHN DEERE	B50 AB3599	S	C	6	6	BL BL	5 9/16 5 9/16	16 16	1 1	18 18	A A	C	229036
17 3/4	15 3/16	2 1/4	CASE/INTERNATIONAL	420, 600	T	C	3	9	GR GR	4 1/2 2 1/2	15 1/2 15 1/2	1/4 C		A A	N	223013
17 3/4	15 5/8	2 3/16	LIFT TRUCKS & LOADERS	MINNEAPOLIS MOLINE	Z	C	3	7	GR GR	6 2 1/2	15 7/8 15 7/8	3/16 3/16		A A	N	281426
17 3/4	15 5/8	2 1/4	CASE/INTERNATIONAL	420, 600	X	C	3	10	GR GR	4 1/2 2 1/2	15 3/4 15 3/4	3/16 3/16		A A	N	287863
17 3/4	15 3/4	2 1/4	LIFT TRUCKS & LOADERS	MINNEAPOLIS MOLINE	T	C	3	6	GR GR	6 2 1/2	15 7/8 15 7/8	C C		A A	N	279576
17 3/4	16 7/8	2 1/4	FORD TRACTOR		X	C	3	9	GR GR	3 9/16 2 13/16	18 1/16 18 1/16	1 1/8 1/4		A A	N	221504
17 3/4	16 7/8	2 3/8	FORD TRACTOR		S	C	4	9	GR GR	3 9/16 2 13/16	18 1/16 18 1/16	1 1/8 1/4		A A	N	229011
17 3/4	17	3	LIFT TRUCKS & LOADERS		B	B	4	6	GR GR	3 3	17 1/4 17 1/4	C C		A A	N	229667
17 3/4	17 7/16	2 1/4	BROWNHOIST	TRACTOR	T	C	3	8	GR GR	2 7/8 2 7/8	17 3/4 17 3/4	C C		A A	N	223057
17 3/4	17 1/2	2 3/8	CASE/INTERNATIONAL		S	C	4	8	GR GR	5 2 3/4	18 3/8 18 3/8	1/4 C		A A	N	229010
17 3/4	18	3 3/4	FORD TRACTOR		T	C	5	8	GR GR	4 4	18 3/8 18 3/8	C C		A A	N	223187
17 3/4	18	5 1/4	LIFT TRUCKS & LOADERS	HYSTER	T	C	7	9	GR GR	6 6	18 18	C C		A A	N	279578
17 3/4	18 1/8	2 7/8	FORD TRACTOR	L550 SKIDDER 9615903	S	C	5	9	GR FR	4 3	18 3/8 18 3/8	1/8 C		A A	N	229048

Vista-Pro Automotive - Core Catalog
(Cores Sorted by Size)

Height	Width	Depth	Application	Description	Fin Type	Fin Matl	Rows	FPI	BH / TH Type	BH / TH Width	BH / TH Length	BH / TH OHF	BH / TH Bolts	BH / TH Shape	Hdr Support	Model #
17 3/4	18 1/8	3	FORD POWER PRODUCTS	5500 POWER UNIT	X	C	4	8	GR GR	4 4	18 3/8 18 3/8	3/16 3/16		A A	N	281649
17 3/4	18 1/8	3	LIFT TRUCKS & LOADERS	HYSTER	X	C	4	8	GR GR	4 1/4 4 1/4	18 3/4 18 3/4	1 1		A A	N	282796
17 3/4	18 1/8	3 3/4	FORD TRACTOR	7000 TRACTOR	X	C	5	8	GR GR	4 4	18 3/8 18 3/8	3/16 3/16		A A	N	221518
17 3/4	18 1/8	3 3/4	FORD TRACTOR		X	C	5	8	GR GR	4 4	18 3/8 18 3/8	C C		A A	N	289467
17 3/4	18 1/8	4 7/16	LIFT TRUCKS & LOADERS	HYSTER BRASS FINS	Z	B	6	10	GR GR	6 6	18 18	C C		A A	N	286499
17 3/4	18 11/16	2	MERCEDES BENZ		VT	C	3	12		2 1/8 2 1/8	18 18	C C		0 0	N	128422
17 3/4	18 3/4	2 15/16	FIAT ALLIS	LIFT TRUCK	Z	C	4	7	GR GR	6 3 7/16	19 3/4 19 3/4	3/16 3/16		A A	N	287640
17 3/4	19 1/8	2 1/4	LIFT TRUCKS & LOADERS	YALE	T	C	3	8	GR GR	3 3	19 5/8 19 5/8	C C		A A	N	279575
17 3/4	19 1/8	2 1/4	LIFT TRUCKS & LOADERS	WHITING TRACK MOBILE	T	C	3	9	GR GR	2 1/2 2 1/2	19 3/8 19 3/8	C C		A A	N	279577
17 3/4	19 1/8	3	LIFT TRUCKS & LOADERS	ALLIS CHALMERS	T	C	4	6	GR GR	6 3 1/2	19 7/8 19 7/8	2 7/8 C		A A	N	223163
17 3/4	19 1/8	3	LIFT TRUCKS & LOADERS	BAKER	T	C	4	8	GR GR	4 3 3/8	20 20	1/4 1/4		A A	N	261606
17 3/4	19 1/4	2	LIFT TRUCKS & LOADERS		VT	C	3	12	GR GR	2 1/2 2 1/2	19 3/8 19 3/8	1/4 1/4		A A	N	124954
17 3/4	19 3/8	2 3/16	LIFT TRUCKS & LOADERS	WHITING TRACK MOBILE	Z	C	3	8	GR GR	2 1/2 2 1/2	19 3/8 19 3/8	C C		A A	N	225525
17 3/4	19 3/8	2 1/4	LIFT TRUCKS & LOADERS	YALE	X	C	3	8	GR GR	3 3	19 5/8 19 5/8	C C		A A	N	286618
17 3/4	20 3/8	2 5/8	MERCURY LIFT TRUCK		VT	C	4	12	GR GR	3 3	20 1/8 20 1/8	C C		A A	N	122010
17 3/4	22	2	MERCEDES BENZ		VT	C	3	14	GR GR	2 1/4 2 1/4	22 5/8 22 5/8	C C		A A	N	128178
17 3/4	22	2	GM		VT	C	3	12	BU GR	3 1/2 2 1/2	22 1/8 22 1/8	C C		A A	N	122229
17 3/4	22	2	CHRYSLER		VT	C	3	12	GR GR	3 3/8 2 1/4	21 5/8 21 5/8	FF C		A A	N	124825
17 3/4	22	2	MERCEDES-BENZ		VT	C	3	16	GR GR	2 3/8 2 3/8	22 22	C C		A A	N	128248
17 3/4	22 9/16	2	MERCEDES BENZ		VT	C	3	12	FR FR	2 1/8 2 1/8	22 1/2 22 1/2	C C		0 A	N	128719
17 3/4	23 1/8	1 1/4	GM		VT	C	2	14	BX BX	2 2	23 23	C C		A A	N	128305
17 3/4	24 3/16	1 1/4	STUDEBAKER		VT	C	2	12	GR GR	2 13/16 2 13/16	24 5/8 24 5/8	C C		A A	N	122221
17 3/4	24 3/16	1 1/4	STUDEBAKER		VT	C	2	12	BU GR	3 1/2 2 1/4	24 3/4 24 7/8	1/4 C		A A	N	122280
17 3/4	24 3/16	1 1/4	STUDEBAKER		VT	C	2	12	BU GR	3 1/2 2 1/4	24 3/4 24 7/8	C C		A A	N	122478
17 3/4	24 3/16	2	STUDEBAKER		VT	C	3	12	GR GR	2 13/16 2 13/16	24 5/8 24 5/8	C C		A A	N	122253
17 3/4	24 3/16	2	STUDEBAKER		VT	C	3	12	BU GR	3 1/2 2 1/4	24 3/4 24 7/8	1/4 C		A A	N	122282
17 3/4	24 3/16	2	STUDEBAKER		VT	C	3	12	BU GR	3 1/2 2 1/4	24 3/4 24 5/8	C C		A A	N	122395
17 3/4	25 5/16	1 1/4	GM		VT	C	2	12	GR GR	3 2 3/4	25 7/16 25 7/16	C C		A A	N	122247
17 3/4	25 5/16	2	GM		VT	C	3	12	GR GR	3 2 3/4	25 7/16 25 7/16	C C		A A	N	122336
17 3/4	27 1/2	2	CHRYSLER		VT	C	3	12	GR GR	3 2 11/16	27 1/4 27 1/4	C C		A A	N	124820
17 13/16	18 11/16	2	CHRYSLER		VT	C	3	12		2 7/8 2 1/8	18 1/4 18 1/2	1/8 C		0 0	N	128378
17 7/8	15 3/8	1 1/4	CHRYSLER		VT	C	2	13	GR GR	2 2	16 3/8 16 3/8	C C		A A	N	128272

Vista-Pro Automotive - Core Catalog
(Cores Sorted by Size)

Height	Width	Depth	Application	Description	Fin Type	Fin Matl	Rows	FPI	BH / TH Type	BH / TH Width	BH / TH Length	BH / TH OHF	BH / TH Bolts	BH / TH Shape	Hdr Support	Model #
17 7/8	18 9/16	2 1/4	LIFT TRUCKS & LOADERS	TOWMOTOR	T	C	3	6	GR GR	5 2 5/8	18 1/2 18 1/2	C C		A A	N	279580
17 7/8	18 11/16	1 1/4	DODGE		VT	C	2	12	GR GR	2 7/8 2	18 1/4 18 1/2	1/4 1/8		A A	N	124547
17 7/8	18 3/4	2 1/4	MINNEAPOLIS MOLINE		X	C	3	6	BL BL	4 1/8 4 1/8	20 3/4 20 3/4	C C	23 23	F F	C	260204
17 7/8	22	1 1/4	DODGE		VT	C	2	13	GR GR	3 3/8 2	21 5/8 21 3/4	FR C		A A	N	124539
17 7/8	22	2	DODGE		VT	C	3	12	GR FR	3 3/8 2 1/8	21 5/8 21 3/4	FF FR		A A	N	128633
17 7/8	22	2	CHRYSLER		VT	C	3	12	BU GR	4 2 1/4	22 1/4 21 3/4	FF C		A A	N	124640
17 7/8	22	2 5/8	CHRYSLER		VT	C	4	12	GR FR	3 3/8 2 3/4	21 5/8 21 5/8	C C		A A	N	128399
17 7/8	22 1/2	2 1/4	INTERNATIONAL		T	C	3	8	GR GR	3 1/2 2 1/2	22 3/8 22 3/8	1/8 1/8		A A	N	270860
17 7/8	22 1/2	3	INTERNATIONAL		T	C	4	9	GR GR	3 1/4 3 1/4	22 7/16 22 7/16	C C		A A	N	270298
17 7/8	23 1/16	3	LIFT TRUCKS & LOADERS	HYSTER	T	C	4	10	GR GR	3 1/2 3 1/2	23 3/4 23 3/4	1/4 1/4		A A	N	261615
17 7/8	23 1/8	2	FORD		VT	C	3	12	BU GR	4 1/4 2 1/4	25 3/4 23 5/8	C C		A A	N	128332
17 7/8	23 5/8	1 1/4	FORD		VT	C	2	12	BU GR	4 1/4 2 1/4	25 3/4 23 5/8	1/4 C		A A	N	128331
17 7/8	24 3/16	1 1/4	FORD		VT	C	2	12	BU GR	4 1/4 2 1/4	25 3/4 23 5/8	C C		A A	N	122228
17 7/8	24 3/16	1 1/4	FORD		VT	C	2	12	BU GR	4 1/4 2 1/4	25 3/4 23 5/8	C C		A A	N	122288
17 7/8	24 3/16	2	FORD		VT	C	3	12	BU GR	4 1/4 2 1/4	25 3/4 23 5/8	C C		A A	N	122246
17 7/8	24 3/16	2	FORD		VT	C	3	12	BU GR	4 1/4 2 1/4	25 3/4 23 5/8	C C		A A	N	122436
17 7/8	25 7/8	1 1/4	CHRYSLER		VT	C	2	12	GR GR	2 3/4 2	25 9/16 25 9/16	C C		A A	N	128641
17 7/8	25 7/8	2	CHRYSLER		VT	C	3	12	GR FR	2 3/4 2 1/8	25 9/16 25 9/16	C C		A A	N	124682
17 7/8	26 3/8	2 5/8	FORD		VT	C	4	12	BU GR	5 3	27 3/8 26 13/16	C C		A A	N	128466
18	15 3/8	1 1/4	DODGE	PLYMOUTH	VT	C	2	16	GR GR	1 3/4 1 3/4	16 3/8 16 3/8	C C		A A	N	122460
18	16 1/4	2 3/16	INT'L HARVESTER	FARMALL H	Z	C	3	7	CR CR	7 1/4 4 1/4	17 3/4 17 3/4	3/8 3/8		A A	N	225526
18	16 1/4	2 3/16	INT'L HARVESTER	MODEL 340	Z	C	3	9	CR CR	7 1/4 4	17 3/4 15 3/4	3/8 7/8		A A	N	225541
18	16 1/4	2 1/4	WITTE	F42, F28 HVY BTM HDR W/TANK & SIDES	X	C	3	8	SQ BH	2 3/4 4 13/16	16 3/8 20	C C	18	A A	C	273468
18	16 1/4	3	INT'L HARVESTER	FARMALL H, SUPER H T/HDR RD REAR	X	C	4	7	CR CR	7 1/4 4 1/4	17 3/4 17 3/4	1/2 1/2		A A	N	221826
18	16 5/16	2 1/4	INT'L HARVESTER	340	T	C	3	6	CR CR	7 1/4 4 1/4	17 3/4 17 3/4	1/2 1/2		A A	N	223170
18	16 5/16	3	INT'L HARVESTER	FARMALL	T	C	4	7	CR CR	7 1/4 4 3/16	17 3/4 17 3/4	3/8 9/16		A A	N	270246
18	17 7/16	2 1/4	LIFT TRUCKS & LOADERS	HYSTER	T	C	3	10	GR GR	3 1/2 3 1/2	17 3/4 17 3/4	C C		A A	N	263458
18	17 1/2	2 1/4	CASE/INTERNATIONAL		X	C	3	7	GR GR	3 3	17 5/8 17 5/8	C C		A A	N	286861
18	17 1/2	5 3/16	LIFT TRUCKS & LOADERS	HYSTER BRASS FINS	Z	B	7	10	GR GR	6 6	18 18	C C		A A	N	286911
18	18 1/8	1 1/4	FORD	RANGER	VT	C	2	12	GR GR	2 2 1/2	18 7/8 18 7/8	C C		A A	N	122704
18	18 1/8	2	FORD	RANGER	VT	C	3	16	GR GR	2 7/8 2 7/8	18 7/8 18 7/8	3/8 3/8		A A	N	128546
18	18 11/16	1 1/4	DODGE		VT	C	2	12	BU GR	4 1 3/4	19 1/4 18 1/2	C C		A A	N	122352

Vista-Pro Automotive - Core Catalog
(Cores Sorted by Size)

Height	Width	Depth	Application	Description	Fin Type	Fin Matl	Rows	FPI	BH / TH Type	BH / TH Width	BH / TH Length	BH / TH OHF	BH / TH Bolts	BH / TH Shape	Hdr Support	Model #
18	18 11/16	1 1/4	PLYMOUTH		VT	C	2	16	GR GR	2 7/8 1 3/4	18 1/4 18 1/2	FR C		A A	N	128781
18	18 11/16	1 1/4	CHRYSLER		VT	C	2	12	GR GR	2 7/8 1 3/4	18 1/4 18 1/2	FF FF		A A	N	124506
18	18 11/16	1 1/4	CHRYSLER		VT	C	2	12	GR GR	1 3/4 1 3/4	18 1/2 18 1/2	C C		A A	N	124945
18	18 11/16	2	CHRYSLER		VT	C	3	12	GR GR	2 7/8 2 1/8	18 1/4 18 1/2	FF C		A A	N	128629
18	18 11/16	2 5/8	CHRYSLER		VT	C	4	12	GR GR	2 7/8 2 7/8	18 1/4 18 1/4	C C		A A	N	128430
18	19 1/8	2 1/4	LIFT TRUCKS & LOADERS	YALE	T	C	3	8	GR GR	3 3	19 5/8 19 5/8	3/16 3/16		A A	N	279584
18	19 1/8	3	LIFT TRUCKS & LOADERS	YALE	T	C	4	8	GR GR	3 3/8 3 3/8	19 7/8 19 7/8	C C		A A	N	279581
18	19 1/4	1 1/4	DODGE	PLYMOUTH	VT	C	2	12	BU GR	4 1 3/4	19 1/4 19	C C		A A	N	122327
18	19 1/4	2	GM		VT	C	3	12	BU GR	3 11/16 2 1/2	19 1/2 19 3/8	C C		A A	N	122255
18	19 3/8	2 1/4	LIFT TRUCKS & LOADERS	YALE	X	C	3	8	GR GR	3 3	19 5/8 19 5/8	3/16 3/16		A A	N	289423
18	19 3/8	2 15/16	LIFT TRUCKS & LOADERS	YALE	Z	C	4	10	GR GR	3 3	19 5/8 19 5/8	C C		A A	N	286619
18	19 3/8	2 15/16	LIFT TRUCKS & LOADERS	YALE	Z	C	4	9	GR GR	3 3/8 3 3/8	19 7/8 19 7/8	3/16 3/16		A A	N	289825
18	19 3/8	3	LIFT TRUCKS & LOADERS	YALE	X	C	4	9	GR GR	3 3/8 3 3/8	19 7/8 19 7/8	C C		A A	N	266133
18	19 11/16	2 1/4	INTERNATIONAL		T	C	3	9	GR GR	3 1/4 2 3/8	19 3/4 19 3/4	1/8 C		A A	N	271945
18	19 11/16	2 1/4	LIFT TRUCKS & LOADERS	HYSTER	T	C	3	8	GR GR	3 1/4 2 3/8	19 7/8 19 7/8	1/4 C		A A	N	260379
18	19 11/16	3	INTERNATIONAL		T	C	4	8	GR GR	3 1/8 3 1/8	19 7/8 19 7/8	C C		A A	N	261956
18	19 13/16	2	JEEP		VT	C	3	15	GR GR	2 1/4 2 1/4	20 20	C C		A A	N	128843
18	20 1/4	1 9/16	MERCEDES BENZ		VE	C	3	14	GR GR	2 1/2 2 1/2	20 1/8 20 1/8	C C		A A	N	128799
18	20 3/8	2	MERCEDES BENZ		VT	C	3	14	GR GR	2 1/2 2 1/2	20 1/8 20 1/8	C C		A A	N	122456
18	21 1/4	2 15/16	CASE/INTERNATIONAL	450B CRAWLER R-41126	Z	C	4	8	GR GR	5 7/8 3 7/16	21 7/8 21 7/8	1/4 C		A A	N	225256
18	21 7/8	2 7/8	CASE/INTERNATIONAL	450B CRAWLER R-46673	S	C	5	7	GR GR	5 7/8 3 7/16	21 7/8 21 7/8	1/4 C		A A	N	229034
18	22	1 1/4	DODGE		VT	C	2	12	GR GR	1 3/4 1 3/4	22 5/16 22 5/16	C C		A A	N	122407
18	22	1 1/4	CHRYSLER		VT	C	2	12	GR GR	2 3/4 2	21 5/8 21 5/8	FF FF		A A	N	124765
18	22	2	CHRYSLER		VT	C	3	12	GR GR	3 3/8 2 1/4	21 5/8 21 3/4	C C		A A	N	124662
18	22	2	CHRYSLER		VT	C	3	12	GR FR	2 3/4 2 1/8	21 5/8 21 5/8	C C		A A	N	128646
18	22 1/2	2 1/4	INTERNATIONAL		T	C	3	6	GR GR	3 1/4 2 1/4	22 1/2 22 1/2	1/4 C		A A	N	260381
18	22 1/2	3	WHITE TRACTOR	3014	T	C	4	8	GR GR	3 1/4 3 1/4	22 1/2 22 1/2	C C		A A	N	260298
18	23 1/16	3	LIFT TRUCKS & LOADERS	HYSTER	T	C	4	8	GR GR	3 7/16 3 7/16	23 3/4 23 3/4	1/8 1/8		A A	N	273439
18	23 5/8	1 1/2	FORD	LIGHT TRUCK	T	C	2	9	GR GR	2 1/2 2	23 3/4 23 3/4	C C		A A	N	263181
18	23 5/8	1 1/4	FORD		VT	C	2	13	GR GR	2 7/8 2	23 3/4 23 3/4	C C		A A	N	124925
18	23 5/8	1 1/4	FORD	LIGHT TRUCK	VT	C	2	16	GR GR	2 7/8 2 7/8	23 3/4 23 3/4	C C		A A	N	124718
18	23 5/8	1 1/4	FORD		VT	C	2	14	GR GR	2 1/2 2	23 3/4 23 3/4	C C		A A	N	122359

Vista-Pro Automotive - Core Catalog
(Cores Sorted by Size)

Height	Width	Depth	Application	Description	Fin Type	Fin Matl	Rows	FPI	BH / TH Type	BH / TH Width	BH / TH Length	BH / TH OHF	BH / TH Bolts	BH / TH Shape	Hdr Support	Model #
18	23 5/8	2	FORD		VT	C	3	12	BU GR	4 1/4 2 1/4	25 3/4 23 5/8	C C		A A	N	122403
18	23 5/8	2	FORD	TRUCK	VT	C	3	12	GR FR	2 11/16 2	23 3/4 23 5/8	C C		A A	N	124808
18	23 5/8	2	FORD		VT	C	3	12	GR GR	2 7/8 2	23 3/4 23 3/4	C C		A A	N	124814
18	23 5/8	2 5/8	FORD		VT	C	4	12	GR GR	2 7/8 2 7/8	23 3/4 23 3/4	C C		A A	N	128660
18	23 3/4	1 7/8	FORD TRUCK		X	C	2	7	GR GR	2 5/8 2	23 3/4 23 3/4	C C		A A	N	288441
18	25 7/8	1 1/4	CHRYSLER		VT	C	2	14	GR GR	2 3/4 2	25 5/8 25 5/8	3/16 3/16		A A	N	122412
18	25 7/8	1 1/4	DODGE		VT	C	2	14	GR GR	3 2 3/4	25 9/16 25 9/16	3/8 3/8		A A	N	124591
18	25 7/8	1 1/4	DODGE		VT	C	2	15	GR GR	3 2	25 9/16 25 9/16	3/8 C		A A	N	124636
18	25 7/8	1 1/4	PLYMOUTH		VT	C	2	12	GR GR	2 2	25 9/16 25 9/16	C C		A A	N	124823
18	25 7/8	1 1/4	MERCEDES-BENZ		VT	C	2	14	GR GR	2 1/8 2 1/8	25 3/8 25 5/8	C C		A A	N	124860
18	25 7/8	2	CHRYSLER		VT	C	3	12	GR GR	3 2 1/8	25 9/16 25 9/16	3/8 C		A A	N	122615
18	25 7/8	2	CHRYSLER		VT	C	3	16	GR GR	3 2 3/4	25 9/16 25 9/16	3/8 C		A A	N	128625
18	25 7/8	2	MERCEDES BENZ		VT	C	3	14	GR GR	2 1/8 2 1/8	25 3/4 25 3/4	C C		A A	N	128446
18	25 7/8	2	CHRYSLER		VT	C	3	16	GR GR	3 2 3/4	25 9/16 25 9/16	C C		A A	N	122495
18	25 7/8	2	CHRYSLER		VT	C	3	14	FR FR	2 1/8 2 1/8	25 9/16 25 9/16	C C		0 A	N	122630
18	25 7/8	2	MERCEDES BENZ		VT	C	3	12	GR GR	2 1/4 2 1/4	25 5/8 25 5/8	C C		A A	N	124916
18	25 7/8	2	CHRYSLER		VT	C	3	16		2 1/8 2 1/8	26 3/8 26 3/8	C C		0 0	N	128528
18	25 7/8	2 5/8	CHRYSLER		VT	C	4	12	GR FR	3 2 3/4	25 9/16 25 9/16	C C		A A	N	128664
18	26	1	CHRYSLER		VE	C	2	14	GR GR	1 3/4 1 3/4	26 1/4 26 1/4	C C		A A	N	124977
18	26 1/4	1 3/4	FORD TRUCK	F500-600 BKT T/HDR 1 1/2" INL 8 1/2" RT	R	C	3	11	BU GR	5 3	27 3/8 26 13/16	1 9/16 C		A A	N	226456
18	26 1/4	2 3/8	FORD TRUCK	F700-750 BKT T/HDR 1 1/2" INL 8 1/2" RT	R	C	4	11	BU GR	5 3	27 3/8 26 13/16	1 5/16 C		A A	N	226455
18	26 3/8	1 1/4	FORD		VT	C	2	12	BU GR	5 3	27 3/8 26 13/16	C C		A A	N	122370
18	26 3/8	2	FORD		VT	C	3	12	BU GR	5 3	27 3/8 26 13/16	C C		A A	N	122372
18	26 7/16	2 1/4	FORD	LIGHT TRUCK	T	C	3	11	BU GR	5 3	27 3/8 26 13/16	C C		A A	N	262840
18 1/8	15 3/4	3	INT'L HARVESTER	300-350	T	C	4	6	GR GR	7 3 3/4	17 1/2 15 1/2	1/2 1/2		A A	N	261224
18 1/8	16 1/4	2 15/16	INT'L HARVESTER	FARMALL 300-350	Z	C	4	7	SQ GR	7 3 3/4	17 1/2 15 1/2	3/8 3/8		A A	N	287520
18 1/8	18	3 3/4	LIFT TRUCKS & LOADERS	HYSTER	T	C	5	8	GR GR	4 1/4 4 1/4	18 3/4 18 3/4	C C		A A	N	265445
18 1/8	18 1/8	2 3/8	FIAT ALLIS	TRACTOR	S	C	4	8	GR GR	5 3/8 2 3/4	18 1/8 18 1/8	1/8 1/8		A A	N	266097
18 1/8	18 11/16	2	CHRYSLER		VT	C	3	12	BU FR	4 2 1/8	19 1/4 19 1/2	C C		A A	N	128341
18 1/8	19 1/8	2 1/4	FIAT ALLIS		T	C	3	7	GR GR	5 7/8 3 3/8	19 3/4 19 3/4	1/4 1/4		A A	N	261636
18 1/8	19 1/8	3 3/4	HERCULES ENGINE		T	C	5	10	GR GR	4 4	20 20	C C		A A	N	279259
18 1/8	19 13/16	1 1/4	JEEP		VT	C	2	16	GR GR	2 1/4 2 1/4	20 20	C C		A A	N	128909

Vista-Pro Automotive - Core Catalog
(Cores Sorted by Size)

Height	Width	Depth	Application	Description	Fin Type	Fin Matl	Rows	FPI	BH / TH Type	BH / TH Width	BH / TH Length	BH / TH OHF	BH / TH Bolts	BH / TH Shape	Hdr Support	Model #
18 1/8	20 3/8	1 1/4	MERCEDES BENZ		VT	C	2	16	GR GR	2 3/8 2 3/8	20 1/8 20 1/8	C C		A A	N	128202
18 1/8	22	1 1/4	CHRYSLER		VT	C	2	16	GR GR	1 3/4 1 3/4	22 5/16 22 5/16	C C		A A	N	124902
18 1/8	22	1 1/4	PLYMOUTH		VT	C	2	12	BU GR	4 2	22 1/4 21 3/4	FF C		A A	N	122344
18 1/8	22	1 1/4	CHRYSLER		VT	C	2	14	BU GR	4 2	22 1/4 21 3/4	C C		A A	N	122470
18 1/8	22	1 1/4	CHRYSLER		VT	C	2	14	BU GR	4 2 1/4	22 1/4 21 1/2	C C		A A	N	128317
18 1/8	22	1 1/4	CHRYSLER		VT	C	2	14	BU GR	4 2	22 1/4 21 5/8	C C		A A	N	128318
18 1/8	22	2	CHRYSLER		VT	C	3	12	BU GR	4 2 1/4	22 5/16 21 3/4	FF C		A A	N	122237
18 1/8	22	2	CHRYSLER		VT	C	3	12	BU GR	4 2 7/8	22 1/4 21 3/4	C C		A A	N	122379
18 1/8	22	2	DODGE		VT	C	3	12	BU GR	4 2 1/2	22 1/4 21 7/8	C C		A A	N	122231
18 1/8	22	2	CHRYSLER		VT	C	3	12	BU GR	4 2 1/4	22 1/4 21 3/4	C C		A A	N	122387
18 1/8	22	2	CHRYSLER		VT	C	3	12	BU GR	4 2 1/4	22 1/4 21 3/4	FF C		A A	N	122399
18 1/8	22	2	CHRYSLER		VT	C	3	12	BU FR	4 2 1/8	22 1/4 21 1/2	C C		A A	N	128612
18 1/8	22	2 5/8	CHRYSLER		VT	C	4	12	BU GR	4 2 7/8	22 1/4 21 3/4	C C		A A	N	122398
18 1/8	22 1/2	3	LIFT TRUCKS & LOADERS	HYSTER	X	C	4	9	GR GR	3 1/2 4 1/2	23 5/8 23 5/8	1/4 1/4		A A	N	265999
18 1/8	22 1/2	3	LIFT TRUCKS & LOADERS	HYSTER	T	C	4	9	GR GR	3 1/4 4 1/2	23 5/8 23 5/8	1/4 1/4		A A	N	279586
18 1/8	25 5/16	2	FORD		VT	C	3	12	BU GR	4 1/4 2 1/4	25 3/4 25	C C		A A	N	128604
18 1/8	27 1/2	1 1/4	CHRYSLER		VT	C	2	16	GR GR	3 2 3/4	27 1/2 27 1/2	C C		A A	N	122596
18 1/8	27 1/2	2	IMPERIAL		VT	C	3	12	GR GR	3 2 11/16	27 1/4 27 1/4	C C		A A	N	122560
18 1/8	27 1/2	2 5/8	CHRYSLER		VT	C	4	12	GR GR	3 2 7/8	27 1/4 27 1/4	C C		A A	N	122552
18 3/16	25 5/16	1 1/4	DODGE	ASPEN	VT	C	2	16	GR GR	1 15/16 1 15/16	26 1/4 26 1/4	C C		A A	N	128723
18 1/4	15 3/4	2 1/4	INT'L HARVESTER	340	T	C	3	8	GR GR	7 3/4 3 7/8	17 1/2 15 5/8	7/8 C		A A	N	275109
18 1/4	17 1/2	2 3/8	DAVID BROWN TRACTOR		R	C	4	7	GR GR	3 3	17 3/4 17 3/4	C C		A A	N	226411
18 1/4	18	2 1/4	FIAT ALLIS	WC-D	T	C	3	7	GR GR	5 3/8 2 7/8	18 1/4 18 1/4	1/8 1/8		A A	N	223122
18 1/4	18	3	FIAT ALLIS	WD-45	T	C	4	6	GR GR	5 3/8 3	18 1/4 18 1/4	3/16 C		A A	N	262813
18 1/4	18	3 3/4	LIFT TRUCKS & LOADERS	HYSTER	T	C	5	9	GR GR	4 1/4 4 1/4	18 3/4 18 3/4	C C		A A	N	279587
18 1/4	18 1/8	2 3/16	FIAT ALLIS	WD-45	Z	C	3	7	GR GR	5 3/8 2 7/8	18 1/4 18 1/4	3/16 3/16		A A	N	225426
18 1/4	18 1/8	2 1/4	FIAT ALLIS	TL-10	X	C	3	6	GR GR	5 3/8 2 7/8	18 1/4 18 1/4	1/4 1/4		A A	N	265919
18 1/4	18 1/8	2 7/8	FORD TRACTOR	285 FERGUSON	S	C	5	7	GR GR	4 3 1/8	18 1/2 18 1/2	C C		A A	N	229012
18 1/4	19 3/8	2 1/4	LIFT TRUCKS & LOADERS	HYSTER	X	C	3	9		3 1/4 3 1/4	19 3/4 19 3/4	5/8 5/8		0 0	N	287529
18 1/4	19 13/16	2	GM		VT	C	3	12	BU GR	3 3/4 2 1/4	19 7/8 19 3/4	C C		A A	N	122200
18 1/4	20 1/4	3	CHRYSLER		T	C	4	9	GR GR	4 3 1/4	20 1/4 20 1/4	C C		A A	N	260661
18 1/4	20 3/8	2	FORD		VT	C	3	12	BU GR	4 5/8 2 1/4	21 1/2 20 1/4	C C		A A	N	122216

Vista-Pro Automotive - Core Catalog
(Cores Sorted by Size)

Height	Width	Depth	Application	Description	Fin Type	Fin Matl	Rows	FPI	BH / TH Type	BH / TH Width	BH / TH Length	BH / TH OHF	BH / TH Bolts	BH / TH Shape	Hdr Support	Model #
18 1/4	20 3/8	2	FORD	T'BIRD CORE	VT	C	3	12	BU GR	4 5/8 2 5/8	21 1/2 20 1/4	C C		A A	N	122248
18 1/4	21 1/4	2 7/8	DODGE	LIGHT TRUCK	S	C	5	10	CR CR	7 1/4 3 5/8	17 3/4 21 1/2	3/8 3/8		A A	N	266331
18 1/4	23 1/16	3	CASE/INTERNATIONAL	190	T	C	4	8	GR GR	4 4	23 3/4 23 3/4	1/8 1/8		A A	N	278762
18 1/4	23 1/16	3 3/4	FIAT ALLIS	190 XT TRACTOR	T	C	5	10	FR FR	3 7/8 3 7/8	23 3/4 23 3/4	C C		0 0	N	223123
18 1/4	23 1/8	3	FIAT ALLIS	190 XT	X	C	4	9	GR GR	3 7/8 3 7/8	23 3/4 23 3/4	1/4 1/4		A A	N	289424
18 1/4	23 1/8	3 11/16	CASE/INTERNATIONAL		Z	C	5	10	GR GR	3 7/8 3 7/8	23 3/4 23 3/4	C C		A A	N	225321
18 1/4	25 7/8	2	FORD		VT	C	3	12	GR GR	3 3	26 13/16 26 13/16	C C		A A	N	124658
18 1/4	26 3/8	2 5/8	FORD		VT	C	4	12	GR GR	3 3	26 13/16 26 13/16	C C		A A	N	128489
18 5/16	23 5/8	2	GM		VT	C	3	12	BU GR	3 11/16 2 1/2	23 3/4 23 3/4	C C		A A	N	122292
18 3/8	16 5/16	2 1/4	TRIUMPH		T	C	3	11	GR GR	2 3/4 2 3/4	16 1/2 16 1/2	C C		A A	N	263625
18 3/8	18	2 1/4	FIAT ALLIS	WD-45	T	C	3	6	CR CR	5 3/4 3 1/4	18 1/4 18 1/4	3/16 3/16		A A	N	223148
18 3/8	18	2 1/4	INT'L HARVESTER		T	C	3	8	GR GR	2 1/2 2 1/2	18 3/4 18 3/4	C C		A A	N	223200
18 3/8	18 1/8	1 7/8	FIAT ALLIS	WD-45	X	C	2	8	CR CR	5 3/4 3 1/4	18 1/4 18 1/4	3/8 1/4		A A	N	287811
18 3/8	18 1/8	2 3/16	INT'L HARVESTER		Z	C	3	9	GR GR	2 1/2 2 1/2	18 3/4 18 3/4	C C		A A	N	225458
18 3/8	18 1/8	2 1/4	FORD TRACTOR	275 MASSEY FERGUSON	X	C	3	9	GR GR	4 2 1/2	18 5/16 18 1/2	1 3/8 C		A A	N	266249
18 3/8	18 1/8	3	MASSEY-FERGUSON	1085	X	C	4	8	GR GR	4 3 1/8	18 3/8 18 3/8	C C		A A	N	281940
18 3/8	18 11/16	1 1/4	DODGE	DART	VT	C	2	12	GR GR	2 7/8 1 3/4	18 1/4 18 1/2	3/16 3/16		A A	N	124638
18 3/8	18 11/16	2	FORD		VT	C	3	12	BU GR	4 2 1/4	19 1/2 18 1/2	C C		A A	N	122302
18 3/8	18 11/16	2	CHRYSLER		VT	C	3	12	GR FR	2 7/8 2 1/8	18 1/4 18 1/2	1/8 C		A A	N	128447
18 3/8	18 3/4	2 3/8	INT'L HARVESTER	539566-R2, 66495-C2, 539561-R2	S	C	4	8	GR GR	2 1/2 2 1/2	18 3/4 18 3/4	C C		A A	N	229013
18 3/8	19 1/4	1 1/4	CHRYSLER		VT	C	2	12	BU GR	4 1 3/4	19 1/4 19	C C		A A	N	122437
18 3/8	19 3/8	1 7/8	FORD	LIGHT TRUCK	X	C	2	7	GR GR	6 2 1/2	19 19	FF C		A A	N	262885
18 3/8	19 3/8	2 1/4	FIAT ALLIS		X	C	3	9	GR GR	6 3 1/2	19 5/8 19 5/8	5/8 5/8		A A	N	260358
18 3/8	22	1 1/4	CHRYSLER		VT	C	2	14	BU GR	4 2	22 1/4 21 3/4	FF FF		A A	N	122435
18 3/8	22	1 1/4	DODGE		VT	C	2	12	GR GR	2 3/4 2	21 5/8 21 5/8	1/4 C		A A	N	124693
18 3/8	22	1 1/4	CHRYSLER		VT	C	2	12		3 3/8 2	21 5/8 21 3/4	1/4 1/4		0 0	N	124542
18 3/8	22	2	CHRYSLER		VT	C	3	12	BU GR	4 2 1/2	22 1/4 21 3/4	C C		A A	N	128800
18 3/8	22	2	CHRYSLER		VT	C	3	12	BU GR	4 2 7/8	22 1/4 21 3/4	FF FF		A A	N	122423
18 3/8	22	2	CHRYSLER		VT	C	3	12	GR GR	4 2 1/2	22 1/4 21 3/4	C C		A A	N	122573
18 3/8	22	2	CHRYSLER		VT	C	3	12	GR GR	3 3/8 2 1/4	21 5/8 21 5/8	1/8 C		A A	N	124663
18 3/8	22	2	CHRYSLER		VT	C	3	12	GR GR	2 3/4 2 1/8	21 5/8 21 5/8	C C		A A	N	128392
18 3/8	25 7/8	2	DODGE TRK		VT	C	3	12	GR GR	3 2 3/4	25 9/16 25 9/16	C C		A A	N	124516

Vista-Pro Automotive - Core Catalog
(Cores Sorted by Size)

Height	Width	Depth	Application	Description	Fin Type	Fin Matl	Rows	FPI	BH / TH Type	BH / TH Width	BH / TH Length	BH / TH OHF	BH / TH Bolts	BH / TH Shape	Hdr Support	Model #
18 7/16	22	2	GM		VT	C	3	12	BU GR	3 3/4 2 3/4	22 1/8 22 1/8	C C		A A	N	122232
18 7/16	23 5/8	2	FORD		VT	C	3	12	BU GR	4 1/4 2 1/4	25 3/4 23 5/8	C C		A A	N	122264
18 7/16	25 7/8	2	FORD		VT	C	3	12	BU GR	4 3/4 2 1/2	27 1/2 26 1/4	C C		A A	N	122274
18 1/2	15 3/16	2 1/4	MASSEY-FERGUSON	B/HDR OFFSET FOR OUTLET	T	C	3	7	SH SH	4 3/4 4	15 5/8 15 5/8	C 1/4		SP A	N	223132
18 1/2	15 5/8	2 15/16	JOHN DEERE	A	Z	C	4	9	BL BL	5 1/2 5 1/2	18 3/8 18 3/8	1 3/8 1 3/8	22 22	B B	C	280469
18 1/2	15 3/4	2 1/4	JOHN DEERE		T	C	3	6	BL BL	5 1/2 5 1/2	18 3/8 18 3/8	1 3/8 1 3/8	22 22	B B	C	261475
18 1/2	15 3/4	2 1/4	JOHN DEERE	A	T	C	3	7	BL BL	5 1/2 5 1/2	18 1/2 18 1/2	C C	22 22	B B	C	271475
18 1/2	15 3/4	3	JOHN DEERE		T	C	4	8	BL BL	5 1/2 5 1/2	18 3/8 18 3/8	C C	22 22	B B	C	278919
18 1/2	16 1/2	2	TRIUMPH		VT	C	3	12	GR GR	2 3/4 2 3/4	16 1/2 16 1/2	C C		A A	N	128367
18 1/2	17 1/16	2 5/8	GM		VT	C	4	12	GR GR	3 3	18 1/2 18 1/2	C C		A A	N	128357
18 1/2	17 1/16	2 5/8	GM		VT	C	4	12	GR GR	3 3	18 1/2 18 1/2	C C		A A	N	128365
18 1/2	18 1/8	3 3/4	LIFT TRUCKS & LOADERS	HYSTER H60F	X	C	5	9	GR GR	4 1/4 4 1/4	18 3/4 18 3/4	C C		A A	N	289972
18 1/2	18 9/16	3	LUFKIN	HB333	T	C	4	8	GR GR	4 3/4 3	19 3/4 19 3/4	1/8 C		A A	N	275482
18 1/2	18 9/16	3 3/4	LIFT TRUCKS & LOADERS	HYSTER H60F	T	C	5	10	GR GR	4 1/4 4 1/4	18 3/4 18 3/4	C C		A A	N	279592
18 1/2	18 11/16	1 1/4	FORD	PICKUP	VT	C	2	12	GR GR	2 9/16 2	18 1/4 18 1/2	C C		A A	N	122508
18 1/2	18 11/16	1 1/4	FORD TRUCK		VT	C	2	12	GR GR	2 9/16 1 3/4	18 1/4 18 1/4	C C		A A	N	122551
18 1/2	18 11/16	2	FORD		VT	C	3	12	GR FR	2 9/16 2	18 1/4 18 1/2	C C		A A	N	122509
18 1/2	19 1/8	3	ELGIN	SWEEPER	T	C	4	8	GR GR	4 4	19 3/4 19 3/4	1/4 1/4		A A	N	223589
18 1/2	19 1/8	3	LIFT TRUCKS & LOADERS	HYSTER	T	C	4	9	GR GR	4 4	19 3/4 19 3/4	C C		A A	N	279591
18 1/2	19 3/8	2 15/16	ELGIN	3D-264	Z	C	4	10	GR GR	4 4	19 3/4 19 3/4	C C		A A	N	288582
18 1/2	20	2 3/8	LIFT TRUCKS & LOADERS	WHITE OH OPPOSITE SIDE	S	C	4	9	GR GR	3 1/2 3 1/2	20 20	1 1		A A	N	273813
18 1/2	20 3/8	2	CHRYSLER		VT	C	3	12	BX BX	2 1/2 2 1/2	20 1/2 20 1/2	C C		A A	N	128309
18 1/2	22	1 1/4	CHRYSLER		VT	C	2	12	BU GR	4 2	22 1/4 21 3/4	FF C		A A	N	122241
18 1/2	22 1/2	3	CHRYSLER		T	C	4	9	BU GR	4 1/4 3 3/8	23 22 5/8	C C		A A	N	260951
18 1/2	23 1/8	2 3/8	FIAT ALLIS		S	C	4	8	GR GR	3 7/8 3 7/8	23 3/4 23 3/4	1/4 1/4		A A	N	266157
18 1/2	25 7/8	1 1/4	CHRYSLER		VT	C	2	14	GR GR	2 3/4 2	25 5/8 25 5/8	3/8 3/16		A A	N	124685
18 1/2	25 7/8	1 1/4	CHRYSLER		VT	C	2	16	GR GR	2 2	25 5/8 25 5/8	C C		A A	N	128411
18 1/2	25 7/8	1 1/4	CHRYSLER		VT	C	2	12	GR GR	3 2	25 9/16 25 9/16	3/8 3/8		A A	N	128642
18 1/2	25 7/8	2	CHRYSLER		VT	C	3	12	GR FR	2 3/4 2 1/8	25 9/16 25 9/16	3/16 C		A A	N	124675
18 1/2	25 7/8	2	CHRYSLER		VT	C	3	16	GR GR	2 3/4 2 3/4	25 9/16 25 9/16	C C		A A	N	124676
18 1/2	25 7/8	2	CHRYSLER		VT	C	3	12	GR GR	2 3/4 2 1/4	25 9/16 25 9/16	C C		A A	N	124772
18 5/8	15 3/8	2	SUNBEAM		VT	C	3	12	GR GR	2 3/16 2 3/16	15 3/4 15 3/4	C C		A A	N	128366

Vista-Pro Automotive - Core Catalog
(Cores Sorted by Size)

Height	Width	Depth	Application	Description	Fin Type	Fin Matl	Rows	FPI	BH / TH Type	BH / TH Width	BH / TH Length	BH / TH OHF	BH / TH Bolts	BH / TH Shape	Hdr Support	Model #
18 5/8	17 1/2	1 3/4	LIFT TRUCKS & LOADERS	CLARK LOADER C/FLO	R	C	3	8	GR	3 1/4	17 7/8	C		A	N	226562
									GR	3 1/4	17 7/8	C		A		
18 5/8	18 1/8	2 3/16	INT'L HARVESTER		Z	C	3	9	GR	2 1/2	18 3/4	C		A	N	289638
									GR	2 1/2	18 3/4	C		A		
18 5/8	18 9/16	2 1/4	FORD		T	C	3	10	BU	4	19 1/2	C		A	N	263254
									GR	2 1/4	18 1/2	C		A		
18 5/8	18 11/16	2	FORD		VT	C	3	12	BU	4	19 1/2	C		A	N	122328
									GR	2 1/4	18 1/2	C		A		
18 5/8	18 3/4	2 7/8	LIFT TRUCKS & LOADERS	BAKER	S	C	5	8	GR	3 1/4	19 3/4	C		A	N	266159
									GR	3 1/4	19 3/4	C		A		
18 5/8	20 7/8	2	TOYOTA		VT	C	3	13	GR	2 1/2	21	C		A	N	128839
									GR	2 1/2	21	C		A		
18 5/8	21 1/4	3	LIFT TRUCKS & LOADERS	CLARK C60	X	C	4	9	GR	3 1/2	21 7/8	C		A	N	289653
									GR	3 1/2	21 7/8	C		A		
18 5/8	21 3/8	3	LIFT TRUCKS & LOADERS	CLARK C60	T	C	4	9	GR	3 1/2	21 7/8	C		A	N	279593
									GR	3 1/2	21 7/8	C		A		
18 5/8	22	2	CHRYSLER		VT	C	3	12	BU	4	22 1/4	FR		A	N	122589
									GR	2 1/4	21 3/4	C		A		
18 5/8	23 1/8	2 7/8	LIFT TRUCKS & LOADERS	CLARK	S	C	5	9	GR	4 1/2	24	1/8		A	N	266105
									GR	4 1/2	24	1/8		A		
18 5/8	25 5/16	2	GM		VT	C	3	12	GR	3	25 7/16	C		A	N	122290
									GR	2 3/4	25 7/16	C		A		
18 5/8	25 5/16	2 5/8	GM		VT	C	4	12	GR	3 3/8	25 7/16	C		A	N	122388
									GR	3 3/8	25 7/16	C		A		
18 5/8	27 1/2	1 1/4	CHRYSLER		VT	C	2	12	GR	2	27 1/4	C		A	N	124735
									GR	2	27 1/4	C		A		
18 5/8	27 1/2	1 1/4	DODGE		VT	C	2	16	GR	2 11/16	27 1/4	3/16		A	N	124996
									GR	2	27 1/4	3/16		A		
18 5/8	27 1/2	1 1/4	CHRYSLER		VT	C	2	12	GR	2 11/16	27 1/4	C		A	N	124677
									GR	2	27 1/4	C		A		
18 5/8	27 1/2	2	CHRYSLER		VT	C	3	12	FR	2 1/16	27 1/4	C		0	N	122626
									FR	2 1/16	27 1/4	C		0		
18 5/8	27 1/2	2	DODGE		VT	C	3	12	GR	2 11/16	27 1/4	C		A	N	124678
									GR	2 11/16	27 1/4	C		A		
18 5/8	27 1/2	2	CHRYSLER		VT	C	3	12	GR	2 11/16	27 1/4	C		A	N	122618
									FR	2 1/16	27 1/4	C		A		
18 11/16	19 13/16	2	GM		VT	C	3	12	BX	2	19 11/16	C		A	N	128480
									BX	2	19 11/16	C		A		
18 11/16	25 5/8	2 1/4	FORD		X	C	3	9	GR	4 3/8	25 1/2	1/4		A	N	265928
									FR	2 1/4	25 1/2	C		A		
18 3/4	13 3/4	3	JOHN DEERE	2240	X	C	4	9		3	13 3/4	C		0	N	260754
										3	13 3/4	C		0		
18 3/4	14 3/8	1 1/4	AUDI		R	C	2	11	GR	2	15	C		A	N	265789
									GR	2	15	C		A		
18 3/4	15 5/8	2 3/16	MASSEY-FERGUSON	FERGUSON DIAMOND T/HDR	Z	C	3	9	SH	4	15 7/8	C		SP	N	225482
									GR	2 3/8	15 3/4	C		A		
18 3/4	15 5/8	2 3/16	MASSEY-FERGUSON	DIAMOND T/HDR	Z	C	3	9	SH	4 1/8	15 3/4	C		SP	N	288685
									GR	2 3/8	15 3/4	C		A		
18 3/4	15 3/4	2 1/4	FORD TRACTOR	202 WORK BULL DIAMOND T/HDR	T	C	3	8	SH	4 1/8	15 3/4	C		SP	N	223171
									GR	2 3/8	15 3/4	C		A		
18 3/4	16 7/8	2 3/16	FORD TRACTOR	BRITISH DIESEL	Z	C	3	10	GR	2 7/8	17 1/4	C		A	N	288596
									GR	2 7/8	17 1/4	C		A		
18 3/4	16 7/8	2 1/4	FORD TRACTOR	BRITISH DIESEL	T	C	3	9	GR	2 7/8	17 1/8	3/16		A	N	263156
									GR	2 7/8	17 1/8	3/16		A		
18 3/4	18 1/8	1 3/4	LIFT TRUCKS & LOADERS	CLARK	S	C	3	6	GR	3 1/8	18	3/16		A	N	229008
									GR	3 1/8	18	3/16		A		
18 3/4	18 1/8	3	LIFT TRUCKS & LOADERS	BAKER, HYSTER	X	C	4	9	GR	3 1/2	19 3/4	C		A	N	289041
									GR	3 1/2	19 3/4	C		A		
18 3/4	19 1/8	2 1/4	LIFT TRUCKS & LOADERS	MINNEAPOLIS MOLINE	T	C	3	8	GR	3 1/2	19 3/4	1/4		A	N	261634
									GR	3 1/2	19 3/4	1/4		A		
18 3/4	19 1/8	2 1/4	MASSEY-FERGUSON		T	C	3	9		3 1/4	19 3/4	1/4		0	N	262797
										2 3/8	19 3/4	C		0		
18 3/4	19 3/8	2 3/16	LIFT TRUCKS & LOADERS	MINNEAPOLIS MOLINE	Z	C	3	9	GR	3 1/2	19 3/4	7/8		A	N	288732
									GR	3 1/2	19 3/4	3/16		A		

Vista-Pro Automotive - Core Catalog
(Cores Sorted by Size)

Height	Width	Depth	Application	Description	Fin Type	Fin Matl	Rows	FPI	BH / TH Type	BH / TH Width	BH / TH Length	BH / TH OHF	BH / TH Bolts	BH / TH Shape	Hdr Support	Model #
18 3/4	20	3 11/16	LIFT TRUCKS & LOADERS	HYSTER	Z	C	5	9	BL BL	6 3/8 6 3/8	22 22	C C	34 34	A A	C	282740
					T	C	4	9	CR CR	6 3/8 3 5/8	21 1/2 21 1/2	1/2 1/2	A A	N	270185	
18 3/4	21 7/8	2 3/16	LIFT TRUCKS & LOADERS	CLARK	Z	C	3	10	GR GR	2 3/4 2 3/4	22 1/8 22 1/8	C C		A A	N	289897
					X	C	3	8	GR GR	2 3/4 2 3/4	22 22	C C		A A	N	266209
18 3/4	26 3/8	2	FORD	PICKUP	VT	C	3	12	GR GR	3 3	26 13/16 26 13/16	C C		A A	N	128476
					VE	C	3	16	GR GR	2 2	27 1/4 27 1/4	C C		A A	N	128852
18 7/8	19	3	TOYOTA LIFT TRUCK		B	C	4	9	GR GR	3 1/8 3 1/8	19 9/16 19 9/16	C C		A A	N	225691
					T	C	3	8	GR GR	6 3 1/2	19 7/8 19 7/8	2 5/8 C	A A	N	260804	
18 7/8	19 3/8	3	MASSEY-FERGUSON	44 LOADER	X	C	4	8	GR GR	6 3 1/2	19 7/8 19 7/8	2 3/8 3/8		A A	N	288677
					VT	C	2	14	BX BX	2 2	19 3/4 19 3/4	C C		A A	N	128303
18 7/8	21 7/16	1 1/4	GM		VT	C	2	14	BX BX	2 2	21 1/4 21 1/4	C C		A A	N	128464
					VT	C	3	12	BX BX	2 2	21 3/8 21 3/8	C C		A A	N	128479
18 7/8	22	1 1/4	CHRYSLER		VT	C	2	12	BU GR	4 2	22 1/4 22 3/4	C C		A A	N	122342
					VT	C	3	12	BU GR	4 2 1/4	22 1/4 21 3/4	C C		A A	N	122250
18 7/8	22	2	CHRYSLER		VT	C	3	12	BU GR	4 2 1/2	22 1/4 21 7/8	C C		A A	N	122252
					VT	C	3	12	BU GR	4 2 3/4	22 1/4 21 3/4	FF FF		A A	N	122421
18 7/8	22	2 5/8	CHRYSLER		VT	C	4	12	BU GR	4 2 13/16	22 1/4 21 7/16	C C		A A	N	128601
					VT	C	3	12	GR GR	4 3	24 3/4 24 3/4	FF C		A A	N	122202
19	15	2 3/16	INT'L HARVESTER	W12	Z	C	3	7	BL BL	5 5/8 5 5/8	17 1/2 17 1/2	1 1/4 1 1/4	23 23	F F	C	281462
					T	C	3	6	BL BL	5 5/8 5 5/8	17 1/2 17 1/2	1 5/8 1 5/8	23 23	A A	C	223233
19	18	3 3/4	LIFT TRUCKS & LOADERS	BAKER CF-600	T	C	5	8	GR GR	3 3/4 3 3/4	17 7/8 17 7/8	C C		A A	N	279602
					Z	C	4	9	GR GR	3 1/2 3 1/2	19 3/4 19 3/4	7/16 7/16	A A	N	289552	
19	18 9/16	2 1/4	OLIVER HART PARR		T	C	3	7	GR GR	3 1/4 3 1/4	18 5/8 18 5/8	C C		A A	N	263450
					T	C	4	7	GR GR	3 3/8 3 3/8	19 11/16 19 11/16	C C		A A	N	265360
19	18 11/16	1 1/4	PLYMOUTH		VT	C	2	13	GR GR	2 7/8 1 3/4	18 1/4 18 1/2	FF FF		A A	N	124737
					T	C	4	8	GR GR	3 1/2 3 1/2	19 3/4 19 3/4	C C		A A	N	279600
19	19 3/8	2 3/16	LINCOLN ELECTRIC	CONTINENTAL ENGINE	Z	C	3	10	GR FR	3 1/8 2 5/16	19 5/8 19 5/8	3/16 C		A A	N	287559
					T	C	3	8	BX BX	2 1/2 2 1/2	19 3/4 19 3/4	C C		A A	N	260644
19	19 13/16	1 1/4	LINCOLN ELECTRIC		VT	C	2	12	GR GR	3 1/8 2 3/8	19 5/8 19 5/8	3/8 3/8		A A	N	124890
					X	C	2	8	GR GR	3 1/8 2 1/4	19 3/4 19 3/4	3/16 3/16		A A	N	221343
19	20	1 7/8	LINCOLN ELECTRIC	200 AMP	X	C	2	8	GR GR	3 3/8 2 3/8	19 5/8 19 5/8	3/8 1/4		A A	N	221271
					VT	C	3	12	BU GR	4 1/8 2 9/16	23 21 7/8	C C		A A	N	122318

Vista-Pro Automotive - Core Catalog
(Cores Sorted by Size)

Height	Width	Depth	Application	Description	Fin Type	Fin Matl	Rows	FPI	BH / TH Type	BH / TH Width	BH / TH Length	BH / TH OHF	BH / TH Bolts	BH / TH Shape	Hdr Support	Model #
19	23 1/8	3	CASE/INTERNATIONAL	680E	X	C	4	8	GR GR	6 3 1/2	23 7/8 23 7/8	3/16 C		A A	N	286520
19	23 5/8	2 1/4	CASE/INTERNATIONAL		T	C	3	9	GR GR	6 3 1/2	23 3/4 23 3/4	1/8 1/8		A A	N	278764
19	23 5/8	3	CASE/INTERNATIONAL	680E	T	C	4	8	GR GR	6 3 1/2	23 7/8 23 7/8	1/8 1/8		A A	N	278763
19	23 3/4	2 7/8	CASE/INTERNATIONAL	680 LOADER L-72507	S	C	5	8	GR GR	6 3 1/2	23 7/8 23 7/8	5/16 C		A A	N	229147
19	23 3/4	3	CASE/INTERNATIONAL	680E	X	C	4	8	GR GR	6 3 1/2	23 7/8 23 7/8	1/4 C		A A	N	266282
19	51 1/4	3 7/16	CROWN COACH		R	C	6	11	BL BL	6 1/4 6 1/4	51 9/16 51 9/16	C C		A A	N	226713
19 1/16	26 1/4	3	FORD		X	C	4	10	GR GR	3 1/4 3 1/4	26 3/8 26 3/8	C C		A A	N	265926
19 1/16	18 1/8	2 3/16	MASSEY-FERGUSON		Z	C	3	10	GR GR	5 2 7/16	18 1/4 18 3/8	3/16 3/16		A A	N	287750
19 1/16	23 1/8	2 7/8	CASE/INTERNATIONAL	W-14 LOADER L-102723	S	C	5	8	GR GR	4 1/2 4 1/2	23 15/16 23 15/16	3/16 3/16		A A	N	229144
19 1/16	23 1/8	3 7/16	CASE/INTERNATIONAL	780B LOADER L-109155	S	C	6	8	GR GR	4 1/2 4 1/2	23 15/16 23 15/16	C C		A A	N	229145
19 1/16	23 1/8	3 15/16	CASE/INTERNATIONAL	780B LOADER L-108998	S	C	7	8	GR GR	4 1/2 4 1/2	23 15/16 23 15/16	C C		A A	N	229146
19 1/8	15	2 1/4	JOHN DEERE	2010 DIESEL	X	C	3	8	GR GR	3 3/8 3 3/8	15 3/4 15 3/4	3/16 3/16		A A	N	221813
19 1/8	15	3	JOHN DEERE	2010 DIESEL	X	C	4	9	GR GR	3 3/8 3 3/8	15 3/4 15 3/4	C C		A A	N	266113
19 1/8	15 3/16	2 1/4	JOHN DEERE	2010 DIESEL	T	C	3	7	GR GR	3 3/8 3 3/8	15 3/4 15 3/4	1/4 1/4		A A	N	265495
19 1/8	15 3/16	2 1/4	JOHN DEERE	2010 DIESEL	T	C	3	7	GR GR	3 3/8 3 3/8	15 3/4 15 3/4	1/8 1/8		A A	N	275112
19 1/8	15 3/4	2 1/4	FORD TRACTOR	3165	T	C	3	9	GR GR	4 1/2 2 1/2	15 3/4 15 3/4	C C		A A	N	223150
19 1/8	18	2 1/4	MASSEY-FERGUSON	MODEL 85	T	C	3	8	GR GR	5 2 7/16	18 1/4 18 3/8	1/4 C		A A	N	223611
19 1/8	18	2 1/4	MASSEY-FERGUSON	85	T	C	3	9	GR GR	5 2 7/16	18 1/4 18 3/8	C 1/4		A A	N	278437
19 1/8	18	3	TOYOTA LIFT TRUCK		B	C	4	9	GR GR	3 1/4 3 1/4	17 3/4 17 3/4	C C		A A	N	225692
19 1/8	18 1/8	2 1/4	GALION	D123554	X	C	3	10	GR GR	3 3/8 3 3/8	18 3/4 18 3/4	C C		A A	N	281551
19 1/8	18 1/8	2 1/4	JOHN DEERE	LOADER	X	C	3	8	GR GR	3 1/4 3 1/4	18 5/8 18 5/8	C C		A A	N	288093
19 1/8	18 1/8	2 1/4	MASSEY-FERGUSON		X	C	3	8	GR GR	5 2 7/16	18 1/4 18 3/8	3/16 3/16		A A	N	265974
19 1/8	18 9/16	2 1/4	JOHN DEERE	1010 DIESEL	T	C	3	8	GR GR	3 1/4 3 1/4	18 5/8 18 5/8	C C		A A	N	263224
19 1/8	18 9/16	2 1/4	JOHN DEERE	1010 DIESEL	T	C	3	7	GR GR	3 1/4 3 1/4	18 5/8 18 5/8	C C		A A	N	275113
19 1/8	19 1/8	2 1/4	KOHLER ENGINES & GEN	T/HDR RD FRONT	T	C	3	7	SH SH	5 7/8 3 1/2	21 3/8 19 3/4	1 3/16 7/16		SP SP	N	260712
19 1/8	19 1/8	3	KOHLER ENGINES & GEN	T/HDR RD FRONT BRASS FINS	T	B	4	7	SH GR	5 7/8 3 1/2	21 1/4 19 7/8	1 3/16 7/16		SP A	N	263118
19 1/8	19 1/4	2 5/8	FORD		VT	C	4	12	FR FR	2 3/4 2 3/4	19 1/8 19 1/8	C C		0 A	N	128401
19 1/8	19 1/4	2 5/8	FORD		VT	C	4	12	GR GR	2 3/4 2 3/4	19 1/8 19 1/8	C C		A A	N	128488
19 1/8	19 3/8	2 1/4	WAUKESHA	T/HDR RD FRONT	X	C	3	9	GR GR	5 7/8 3 1/2	21 1/4 19 7/8	2 C		A A	N	288197
19 1/8	20 5/8	2 1/4	LIFT TRUCKS & LOADERS	HOUGH	X	C	3	9	CR CR	7 1/4 4 1/2	17 3/4 21	3/8 3/4		A A	N	281659
19 1/8	20 13/16	3	FORD	LIGHT TRUCK	T	C	4	8		3 3	21 21	C C		0 0	N	261629
19 1/8	48 15/16	6	CROWN COACH		T	C	8	9	BL BL	8 3/8 8 3/8	52 52	C C	62 62	A A	C	223324

Vista-Pro Automotive - Core Catalog
(Cores Sorted by Size)

Height	Width	Depth	Application	Description	Fin Type	Fin Matl	Rows	FPI	BH / TH Type	BH / TH Width	BH / TH Length	BH / TH OHF	BH / TH Bolts	BH / TH Shape	Hdr Support	Model #
19 1/4	15 5/8	2 1/4	MASSEY-FERGUSON		X	C	3	8	GR GR	4 1/2 2 1/2	15 3/4 15 3/4	C C		A A	N	221834
19 1/4	15 15/16	1 1/4	PEUGEOT		VT	C	2	12	GR GR	1 7/8 1 7/8	15 5/8 15 5/8	C C		A A	N	128115
19 1/4	17 7/16	3 3/4	LIFT TRUCKS & LOADERS	BAKER LIFT TRUCK	T	C	5	8	GR GR	4 4	18 18	C C		A A	N	265399
19 1/4	17 1/2	2 1/4	MINNEAPOLIS MOLINE	U, UTU	X	C	3	7	GR GR	6 3/8 3	18 18	5/16 5/16		A A	N	281458
19 1/4	17 1/2	3	LIFT TRUCKS & LOADERS	BAKER	X	C	4	8	GR GR	4 4	18 18	3/16 3/16		A A	N	289270
19 1/4	18	2 1/4	MINNEAPOLIS MOLINE	UTA, UTU	T	C	3	8	GR GR	6 3/8 3	18 18	1/4 1/4		A A	N	223612
19 1/4	18	3	MASSEY-FERGUSON	FERGUSON 85 DIESEL	T	C	4	9	GR GR	5 3	18 1/4 18 1/4	3/16 C		A A	N	279816
19 1/4	18 1/8	2 3/16	MASSEY-FERGUSON		Z	C	3	10	GR GR	5 2 1/2	18 3/8 18 3/8	2 3/4 C		A A	N	286611
19 1/4	18 1/8	2 3/16	MINNEAPOLIS MOLINE	UTU, UTA	Z	C	3	9	GR GR	6 3/8 3	18 18	1/4 1/4		A A	N	288164
19 1/4	18 1/8	2 7/8	LIFT TRUCKS & LOADERS	CLARK	S	C	5	8	GR GR	3 7/16 3 7/16	19 13/16 19 13/16	1/8 1/8		A A	N	229026
19 1/4	18 9/16	3	CASE/INTERNATIONAL	700-800	T	C	4	7	GR GR	6 3 1/8	19 1/2 19 1/2	3/16 3/16		A A	N	275089
19 1/4	18 9/16	3 3/4	REX	PAVER	T	C	5	9	GR GR	4 1/8 4 1/8	19 7/8 19 7/8	C C		A A	N	279898
19 1/4	18 3/4	3	CASE/INTERNATIONAL		X	C	4	8	GR GR	3 1/2 3 1/2	19 3/4 19 3/4	3/16 3/16		A A	N	286537
19 1/4	19 1/4	2	FORD		VT	C	3	12	GR GR	2 1/2 2 1/2	19 1/8 19 1/8	C C		A A	N	124593
19 1/4	20	2 7/8	CASE/INTERNATIONAL	A-184253	S	C	5	8	GR GR	4 3/4 4 3/4	20 7/8 20 7/8	C C		A A	N	229149
19 1/4	20	3 7/16	CASE/INTERNATIONAL	W-11 LOADER A-184256, A-171322	S	C	6	9	GR GR	4 3/4 4 3/4	20 7/8 20 7/8	1/2 1/2		A A	N	229151
19 1/4	20 5/8	2 3/8	CASE/INTERNATIONAL	1835-1845 A-184582, A-171080, A-171582, A-184250	S	C	4	9	GR GR	4 3/4 4 3/4	20 7/8 20 7/8	7/8 7/8		A A	N	229152
19 1/4	20 5/8	3	LIFT TRUCKS & LOADERS	CLARK 500	X	C	4	9	GR GR	3 1/2 3 1/2	21 7/8 21 7/8	C C		A A	N	289898
19 1/4	20 5/8	3 11/16	CASE/INTERNATIONAL	450B A-172867	Z	C	5	8	GR GR	4 3/4 4 3/4	20 7/8 20 7/8	1/8 1/8		A A	N	225001
19 1/4	20 5/8	3 15/16	CASE/INTERNATIONAL	A-184259	S	C	7	9	GR GR	4 3/4 4 3/4	20 7/8 20 7/8	C C		A A	N	229154
19 1/4	20 13/16	3	LIFT TRUCKS & LOADERS	CLARK 500	T	C	4	9	GR GR	3 1/2 3 1/2	21 7/8 21 7/8	1/8 1/8		A A	N	279615
19 1/4	22 1/2	2 1/4	LIFT TRUCKS & LOADERS	HYSTER	X	C	3	9	GR GR	3 1/2 3 1/2	23 3/4 23 3/4	C C		A A	N	289042
19 1/4	22 1/2	3	LIFT TRUCKS & LOADERS	HYSTER	T	C	4	10	GR GR	3 1/2 3 1/2	23 3/4 23 3/4	C C		A A	N	223116
19 1/4	23 1/2	3	CASE/INTERNATIONAL	W-14 LOADER	B	C	4	8	GR GR	4 1/2 4 1/2	24 24	1/8 1/8		A A	N	229501
19 1/4	25 7/8	1 1/4	FORD	PICKUP	VT	C	2	13	GR GR	3 3	26 26	C C		A A	N	124952
19 1/4	25 7/8	1 1/4	FORD		VT	C	2	16	GR GR	3 3	26 13/16 26 13/16	C C		A A	N	128976
19 1/4	25 7/8	2	FORD		VT	C	3	12	GR GR	3 3	26 13/16 26 13/16	C C		A A	N	124541
19 1/4	25 7/8	2	FORD		VT	C	3	16	GR GR	3 3	26 13/16 26 13/16	C C		A A	N	128978
19 1/4	25 7/8	2	FORD TRUCK		VT	C	3	14	GR GR	3 3	26 13/16 26 13/16	C C		A A	N	122703
19 1/4	25 7/8	2	FORD		VT	C	3	12	GR GR	3 3	26 26	C C		A A	N	124719
19 1/4	25 7/8	2 5/8	FORD		VT	C	4	12	GR GR	3 3	26 13/16 26 13/16	C C		A A	N	124815
19 1/4	26 1/4	1 3/4	FORD	TRUCK	R	C	3	10	GR GR	3 3	26 13/16 26 13/16	C C		A A	N	226887

Vista-Pro Automotive - Core Catalog
(Cores Sorted by Size)

Height	Width	Depth	Application	Description	Fin Type	Fin Matl	Rows	FPI	BH / TH Type	BH / TH Width	BH / TH Length	BH / TH OHF	BH / TH Bolts	BH / TH Shape	Hdr Support	Model #
19 3/8	16 7/8	2 3/16	MINNEAPOLIS MOLINE	JET STAR	Z	C	3	9	GR BL	3 1/2 4 7/8	17 7/8 19 7/8	3/8 1 1/8	20	A A	C	287760
19 3/8	16 7/8	4 7/16	LIFT TRUCKS & LOADERS	HYSTER BRASS FINS	Z	B	6	9	GR GR	6 6	18 18	3/16 3/16		A A	N	286516
19 3/8	16 7/8	5 1/4	LIFT TRUCKS & LOADERS	TOWMOTOR V60-C	X	C	7	6	GR GR	6 6	18 18	1/4 1/4		A A	N	266047
19 3/8	16 7/8	5 1/4	LIFT TRUCKS & LOADERS	HYSTER	T	C	7	7	GR GR	6 6	18 18	C C		A A	N	279620
19 3/8	17 7/16	2 1/4	MINNEAPOLIS MOLINE	445 HVY BTM HDR	T	C	3	8	GR BH	3 1/2 4 7/8	17 7/8 19 7/8	1 1 5/8	20	A A	C	223266
19 3/8	17 1/2	2 1/4	FIAT ALLIS	HD-17	X	C	3	6	GR GR	5 3/8 2 5/8	18 18	3/16 3/16		A A	N	221807
19 3/8	17 1/2	3	FIAT ALLIS	HD-17	X	C	4	9	GR GR	5 3/8 4	18 18	3/16 3/16		A A	N	289459
19 3/8	18	2 1/4	FIAT ALLIS	HD-17	T	C	3	8	GR GR	5 3/8 2 5/8	18 18	1/4 1/4		A A	N	223127
19 3/8	18	2 1/4	LIFT TRUCKS & LOADERS	CLARK	T	C	3	8	GR GR	3 1/4 3 1/4	17 3/4 17 3/4	3/16 3/16		A A	N	279617
19 3/8	18 1/8	2 3/16	LIFT TRUCKS & LOADERS	CLARK	Z	C	3	9	GR GR	3 1/4 3 1/4	17 3/4 17 3/4	3/16 3/16		A A	N	289899
19 3/8	18 1/8	2 1/4	FIAT ALLIS		X	C	3	8	GR GR	5 3/8 2 5/8	18 18	3/16 C		A A	N	266129
19 3/8	18 1/8	2 15/16	LIFT TRUCKS & LOADERS	HYSTER	Z	C	4	9	GR GR	3 1/2 3 1/2	19 7/8 19 7/8	3/16 3/16		A A	N	288021
19 3/8	18 1/8	3 3/4	FIAT ALLIS	HD-17	X	C	5	8	GR GR	5 3/8 3 7/8	18 18	FF C		A A	N	260362
19 3/8	18 9/16	2 1/4	FIAT ALLIS	G-226	T	C	3	7	GR GR	6 3 7/16	19 3/4 19 3/4	3/8 3/8		A A	N	274984
19 3/8	18 3/4	2 1/4	FIAT ALLIS		X	C	3	8	GR GR	6 3 1/2	19 3/4 19 3/4	5/8 5/8		A A	N	260363
19 3/8	18 3/4	2 3/8	FIAT ALLIS	540 LOADER 1011218-03	S	C	4	6	GR GR	3 3/8 3 3/8	19 3/4 19 3/4	C C		A A	N	229183
19 3/8	18 3/4	2 15/16	FIAT ALLIS		Z	C	4	6	GR GR	3 3/8 3 3/8	19 3/4 19 3/4	C C		A A	N	281699
19 3/8	18 3/4	3	LIFT TRUCKS & LOADERS	HYSTER	X	C	4	8	GR GR	3 1/2 3 1/2	20 20	C C		A A	N	289936
19 3/8	19 1/8	2 1/4	DETROIT DIESEL		T	C	3	9	CR CR	4 3	19 1/2 19 1/2	C C		A A	N	223088
19 3/8	19 1/8	3	DETROIT DIESEL	COMPRESSOR	T	C	4	8	GR GR	4 1/4 4 1/4	19 7/8 19 7/8	1/8 1/8		A A	N	278976
19 3/8	19 1/8	3	LIFT TRUCKS & LOADERS	HYSTER	T	C	4	8	GR GR	3 1/2 3 1/2	20 20	C C		A A	N	279618
19 3/8	19 3/8	2 3/8	CASE/INTERNATIONAL	W-11 LOADER L-103034	S	C	4	8	GR GR	3 7/16 3 7/16	19 3/4 19 3/4	C C		A A	N	229155
19 3/8	19 3/8	3	LIFT TRUCKS & LOADERS	TOYOTA LIFT	X	C	4	8	GR GR	3 1/2 3 1/2	19 3/4 19 3/4	C C		A A	N	286912
19 3/8	19 1/2	3	CASE/INTERNATIONAL	W-11 LOADER	B	C	4	8	GR GR	3 7/16 3 7/16	19 3/4 19 3/4	C C		A A	N	278767
19 3/8	20	3	LIFT TRUCKS & LOADERS	CLARK	X	C	4	9	GR GR	3 1/2 3 1/2	21 3/4 21 3/4	C C		A A	N	266428
19 7/16	19 13/16	2	FORD		VT	C	3	12	BU GR	4 5/8 2 1/2	21 1/2 20	1/4 C		A A	N	122224
19 1/2	15 3/16	2 1/4	FORD TRACTOR		T	C	3	8	GR GR	4 1/2 2 1/2	15 3/4 15 3/4	C C		A A	N	223151
19 1/2	15 5/8	2 1/4	CASE/INTERNATIONAL		X	C	3	6	GR GR	6 2 3/8	15 3/4 15 3/4	1/16 1/16		A A	N	260551
19 1/2	16 7/8	4 1/2	CATERPILLAR	LIFT TRUCK	T	C	6	9	GR GR	6 6	18 18	1/4 1/4		A A	N	265671
19 1/2	17 1/16	2 5/8	TOYOTA LIFT TRUCK		VT	C	4	12	GR GR	3 3	17 1/8 17 1/8	C C		A A	N	122009
19 1/2	17 1/2	2 3/8	IVECO TRUCK	220 Z	R	C	4	11	GR GR	2 3/4 2 3/4	18 18	C C		A A	N	226525
19 1/2	18	3	LIFT TRUCKS & LOADERS	HYSTER	T	C	4	9	GR GR	3 1/2 3 1/2	20 20	C C		A A	N	223239

Vista-Pro Automotive - Core Catalog
(Cores Sorted by Size)

Height	Width	Depth	Application	Description	Fin Type	Fin Matl	Rows	FPI	BH / TH Type	BH / TH Width	BH / TH Length	BH / TH OHF	BH / TH Bolts	BH / TH Shape	Hdr Support	Model #
19 1/2	18	3	LIFT TRUCKS & LOADERS	SA-60, AX-60	T	C	4	8	GR GR	6 5/16 3	18 18	1/8 C		A A	N	273473
19 1/2	18 1/8	3 3/4	LIFT TRUCKS & LOADERS	HYSTER H40F	X	C	5	8	GR GR	4 1/4 4 1/4	18 3/4 18 3/4	3/16 3/16		A A	N	289043
19 1/2	18 9/16	2 1/4	LIFT TRUCKS & LOADERS	TOWMOTOR	T	C	3	10	GR GR	6 3 1/4	19 3/4 19 3/4	1/4 1/4		A A	N	263093
19 1/2	18 11/16	1 1/4	DODGE TRK		VT	C	2	12	GR GR	2 7/8 1 3/4	18 1/4 18 1/2	1/4 1/8		A A	N	124521
19 1/2	18 11/16	2	CHRYSLER		VT	C	3	12	GR GR	2 7/8 2 1/8	18 1/4 18 1/2	C C		A A	N	128471
19 1/2	19 1/4	2	FORD		VT	C	3	12	GR GR	2 1/4 2 1/4	19 3/8 19 3/8	C C		A A	N	128669
19 1/2	19 3/8	2 1/4	DETROIT DIESEL	2-71 DIESEL	X	C	3	11		4 3	19 1/2 19 1/2	15/16 7/16		0 0	N	287224
19 1/2	19 11/16	2 1/4	FORD		T	C	3	10	GR GR	4 2 1/4	20 20	C C		A A	N	264043
19 1/2	19 11/16	3	FORD		T	C	4	10	GR FR	4 3	20 20	C C		A A	N	260601
19 1/2	19 13/16	2	FORD		VT	C	3	12	GR GR	4 2 1/4	20 20	1/8 C		A A	N	122330
19 1/2	23 1/16	3 3/4	CASE/INTERNATIONAL	DROTT BACKHOE	T	C	5	8	GR GR	4 4	23 3/4 23 3/4	C C		A A	N	223267
19 1/2	23 1/8	3 3/4	DROTT	BACKHOE	X	C	5	8	SQ SQ	4 4	23 3/4 23 3/4	C C		A A	N	289956
19 1/2	25	2 7/8	CASE/INTERNATIONAL	MC4000 LIFT L-60005	S	C	5	7	GR GR	4 5/16 4 5/16	25 3/4 25 3/4	3/8 3/8		A A	N	229156
19 1/2	25 5/16	3 3/4	LIFT TRUCKS & LOADERS	CLARK CHY-100, C-120	T	C	5	9	GR GR	4 1/4 4 1/4	25 3/4 25 3/4	C C		A A	N	279623
19 1/2	25 5/8	3 3/4	LIFT TRUCKS & LOADERS	CLARK CHY-100 C120	X	C	5	9	GR GR	4 1/4 4 1/4	25 3/4 25 3/4	C C		A A	N	289055
19 1/2	26 3/8	1 1/4	FORD TRUCK		VT	C	2	13	GR GR	3 3	26 13/16 26 13/16	C C		A A	N	122588
19 1/2	29 1/4	3 3/4	FIAT ALLIS	TL-545 LOADER	T	C	5	7	GR GR	5 5	29 3/4 29 3/4	1/8 1/8		A A	N	223158
19 5/8	8 13/16	1 1/4	FORD		VT	C	2	14	GR GR	1 7/8 1 7/8	9 7/16 9 7/16	C C		A A	N	124906
19 5/8	14 7/8	2	GM		VT	C	3	14	GR GR	2 3/8 2 3/8	16 1/2 16 1/2	3/8 3/8		A A	N	128195
19 5/8	15 1/4	1	GMC TRUCK		VE	C	2	14	GR GR	2 3/8 2 3/8	16 1/2 16 1/2	1 1		A A	N	128157
19 5/8	15 1/4	1 9/16	GM		VE	C	3	14	GR GR	2 3/8 2 3/8	16 1/2 16 1/2	C C		A A	N	128158
19 5/8	16 7/8	2 1/4	LIFT TRUCKS & LOADERS	TOYOTA LIFT	X	C	3	8	GR GR	3 3	17 1/4 17 1/4	C C		A A	N	221855
19 5/8	16 7/8	2 3/8	TOYOTA LIFT TRUCK		R	C	4	11	GR GR	3 1/8 3 1/8	17 1/4 17 1/4	C C		A A	N	225693
19 5/8	17	2 1/4	LIFT TRUCKS & LOADERS	TOYOTA LIFT BRASS FINS	B	B	3	8	GR GR	3 3	17 1/8 17 1/8	C C		A A	N	229650
19 5/8	17	3	LIFT TRUCKS & LOADERS	TOYOTA LIFT	B	C	4	7	FR FR	3 1/8 3 1/8	17 1/4 17 1/4	C C		A A	N	229527
19 5/8	17	3	LIFT TRUCKS & LOADERS	TOYOTA LIFT	B	C	4	6	FR FR	3 3	17 1/4 17 1/4	C C		0 0	N	229656
19 5/8	17 1/16	2 5/8	TOYOTA LIFT TRUCK		VT	C	4	12	GR GR	3 1/8 3 1/8	17 1/4 17 1/4	C FF		A A	N	122712
19 5/8	17 1/2	3	LIFT TRUCKS & LOADERS	CLARK C500	X	C	4	6	GR GR	3 1/4 3 1/4	18 18	C C		A A	N	289169
19 5/8	18	2 1/4	LIFT TRUCKS & LOADERS	CLARK C500 C/FLO	T	C	3	8	GR GR	3 1/4 3 1/4	18 18	C C		A A	N	223225
19 5/8	18 1/8	2 3/16	LIFT TRUCKS & LOADERS	CLARK C500	Z	C	3	9	GR GR	3 1/4 3 1/4	18 18	3/16 3/16		A A	N	225486
19 5/8	18 1/8	2 1/4	OLIVER HART PARR	COMBINE 88	X	C	3	6	GR GR	6 3/4 3	18 3/4 18 3/4	3/16 3/16		A A	N	280900
19 5/8	18 9/16	2 1/4	OLIVER HART PARR	88 DIESEL	T	C	3	6	GR GR	6 3/4 3	18 3/4 18 3/4	FF FF		A A	N	278459
19 5/8	19 1/8	2 1/4	LIFT TRUCKS & LOADERS	CLARK	T	C	3	9	GR GR	4 1/4 4 1/4	19 5/8 19 5/8	FF FF		A A	N	279626

Vista-Pro Automotive - Core Catalog
(Cores Sorted by Size)

Height	Width	Depth	Application	Description	Fin Type	Fin Matl	Rows	FPI	BH / TH Type	BH / TH Width	BH / TH Length	BH / TH OHF	BH / TH Bolts	BH / TH Shape	Hdr Support	Model #
19 5/8	19 1/8	3	LIFT TRUCKS & LOADERS	CLARK A630B	T	C	4	8	FR FR	3 1/8 3 1/8	19 5/8 19 5/8	C C		0 0	N	279625
19 5/8	19 3/8	2 3/16	LIFT TRUCKS & LOADERS	CLARK	Z	C	3	10	GR GR	4 1/4 4 1/4	19 5/8 19 5/8	3/16 3/16		A A	N	289269
19 5/8	19 3/8	2 15/16	LIFT TRUCKS & LOADERS	CLARK A630B	Z	C	4	9	SQ SQ	3 1/8 3 1/8	19 5/8 19 5/8	3/16 3/16		A A	N	289054
19 5/8	20 5/8	2 1/4	LIFT TRUCKS & LOADERS	CASE LOADER 1842U	X	C	3	7	GR GR	4 4	21 3/4 21 3/4	1 1/2 1 1/2		A A	N	289921
19 5/8	21 3/8	2 1/4	CASE/INTERNATIONAL	1842 U LOADER	T	C	3	7	GR GR	4 4	21 3/4 21 3/4	1 1/2 1 1/2		A A	N	278770
19 11/16	18 3/4	1 3/4	FORD		R	C	3	8		4 3/8 2 5/16	17 1/2 18 1/2	1/4 1/4		0 0	N	265921
19 11/16	17 1/2	2 15/16	OLIVER HART PARR	C, 18-27, 18-28	Z	C	4	7	BL BL	6 6	20 1/2 20 1/2	1 1/4 1 1/4	27 27	F F	C	281457
19 11/16	18 9/16	2 1/4	OLIVER HART PARR	88 DIESEL	T	C	3	6	GR GR	6 3/4 3	18 3/4 18 3/4	1/4 1/4		A A	N	261219
19 11/16	18 9/16	3	OLIVER HART PARR	88	T	C	4	6	GR GR	6 3/4 3	18 3/4 18 3/4	1/4 C		A A	N	263062
19 3/4	14 7/8	1 1/4	OMNI-HORIZON		VT	C	2	16	GR GR	1 5/8 1 5/8	15 3/4 15 3/4	C C		A A	N	124982
19 3/4	17 1/2	3	OLIVER HART PARR	80	X	C	4	8	BL BL	6 6	20 5/8 20 5/8	1 3/8 1 3/8	27 27	F F	C	221513
19 3/4	18	3	LIFT TRUCKS & LOADERS	CLARK C500, C/FLO.	B	C	4	8	GR GR	3 3/8 3 3/8	17 7/8 17 7/8	1/8 1/8		A A	N	277402
19 3/4	18 1/8	3 3/4	LIFT TRUCKS & LOADERS	HYSTER H60F	X	C	5	9	GR GR	4 1/4 4 1/4	18 3/4 18 3/4	C C		A A	N	265996
19 3/4	18 1/8	3 3/4	LIFT TRUCKS & LOADERS	CATERPILLAR LIFT	X	C	5	7	GR GR	5 1/4 5 1/4	18 3/4 18 3/4	C C		A A	N	282761
19 3/4	18 3/4	1 7/8	FORD	LIGHT TRUCK	X	C	2	6	SQ SQ	4 3/8 2 3/8	19 19	C 1/4		A A	N	262829
19 3/4	19 1/8	2 1/4	CONTINENTAL	LINCOLN WELDER	T	C	3	8	GR GR	6 3 3/8	19 3/4 19 3/4	1/4 1/4		A A	N	261140
19 3/4	19 1/8	2 1/4	LIFT TRUCKS & LOADERS	HOUGH 25B LOADER	T	C	3	6	GR GR	4 4	19 3/4 19 3/4	FF FF		A A	N	279632
19 3/4	19 3/8	2 1/4	DRESSER INDUSTRIES	HOUGH H25-B	X	C	3	9	GR GR	4 4	19 3/4 19 3/4	1/4 1/4		A A	N	221501
19 3/4	19 3/8	2 1/4	LIFT TRUCKS & LOADERS	HOUGH 25-B LOADER	X	C	3	6	GR GR	4 4	19 3/4 19 3/4	3/16 3/16		A A	N	221823
19 3/4	19 3/8	2 7/8	FORD POWER PRODUCTS	D7JL-8005-AA	S	C	5	10	GR GR	4 1/4 4 1/4	19 5/8 19 5/8	C C		A A	N	229046
19 3/4	19 11/16	2 1/4	LINCOLN ELECTRIC	S-6090	T	C	3	8	GR GR	6 3 1/2	19 3/4 19 3/4	1/8 1/8		A A	N	271140
19 3/4	20 1/4	2 1/4	JOHN DEERE	D15-27	T	C	3	6	BL BL	15 7/8 5 3/4	23 1/2 23 1/2	1 7/16 1 7/16	30 30	A A	C	278920
19 3/4	20 1/4	3	JOHN DEERE		T	C	4	6	BL BL	15 3/4 5 3/4	23 1/2 23 1/2	1 3/8 C	30 22	A A	C	278921
19 3/4	20 5/8	3	JOHN DEERE		X	C	4	8	BL BL	6 3/16 6 3/16	22 7/8 22 7/8	1 5/8 1 5/8	22 23	F F	C	280468
19 3/4	21 7/8	2 15/16	LIFT TRUCKS & LOADERS	YALE	Z	C	4	6	SQ SQ	3 3	22 22	C C		A A	N	282776
19 3/4	22	2	GM		VT	C	3	12	BU GR	3 1/2 2 1/2	22 1/8 22 1/8	C C		A A	N	122263
19 3/4	24 3/16	3 3/4	LIFT TRUCKS & LOADERS	TROJAN M134	T	C	5	9	GR GR	4 4	24 24	C C		A A	N	263229
19 3/4	27 1/2	1 1/4	CHRYSLER		VT	C	2	12	GR GR	2 11/16 2	27 1/4 27 1/4	3/8 C		A A	N	124939
19 3/4	27 1/2	2	CHRYSLER		VT	C	3	12	GR FR	2 11/16 2 1/16	27 1/4 27 1/4	C C		A A	N	122621
19 3/4	27 1/2	2	IMPERIAL		VT	C	3	14	GR GR	2 11/16 2 11/16	27 1/4 27 1/4	C C		A A	N	124798
19 3/4	27 1/2	2	CHRYSLER		VT	C	3	14	GR GR	2 1/8 2 1/8	27 1/4 27 1/4	C C		A A	N	124821
19 3/4	27 1/2	2	CHRYSLER		VT	C	3	16	GR GR	2 1/8 2 1/8	27 1/4 27 1/4	C C		A A	N	128529

Vista-Pro Automotive - Core Catalog
(Cores Sorted by Size)

Height	Width	Depth	Application	Description	Fin Type	Fin Matl	Rows	FPI	BH / TH Type	BH / TH Width	BH / TH Length	BH / TH OHF	BH / TH Bolts	BH / TH Shape	Hdr Support	Model #
19 13/16	19 1/8	2 1/4	FORD		T	C	3	8		4 2 1/4	18 18 3/16	FF C		0 0	N	265409
19 13/16	19 1/4	1 1/4	CHEVROLET		VT	C	2	12	BU GR	3 11/16 2 1/2	19 1/2 19 3/8	C C		A A	N	128602
19 13/16	19 1/4	2	GM		VT	C	3	12	BU GR	3 11/16 2 1/2	19 1/2 19 3/8	C C		A A	N	122257
19 7/8	18	4 1/2	JOHN DEERE		T	C	6	7	GR GR	5 3/8 5 3/8	18 3/4 18 3/4	C C		A A	N	223253
19 7/8	18 1/8	2 1/4	GALION	12D 4409UD-236	X	C	3	9	GR GR	4 4	18 7/8 18 7/8	C C		A A	N	289153
19 7/8	18 1/8	4 7/16	JOHN DEERE	440A SKIDDER AT42555	S	C	8	8	GR GR	5 3/8 5 3/8	18 3/4 18 3/4	1/4 1/4		A A	N	229032
19 7/8	18 1/8	4 7/16	JOHN DEERE	440A BRASS FINS	Z	B	6	6	GR GR	5 3/8 5 3/8	18 3/4 18 3/4	1/4 1/4		A A	N	286642
19 7/8	18 9/16	2 1/4	GALION	ROLLER	T	C	3	9	GR GR	4 4	18 7/8 18 7/8	C C		A A	N	279212
19 7/8	19 1/8	2 1/4	LINCOLN ELECTRIC	LINCOLN WELDER	T	C	3	8	GR GR	4 4	19 3/4 19 3/4	1/4 1/4		A A	N	223172
19 7/8	19 3/8	2 3/16	CONTINENTAL	LINCOLN WELDER	Z	C	3	9	GR GR	4 4	19 3/4 19 3/4	3/16 3/16		A A	N	225418
19 7/8	19 3/8	3	LIFT TRUCKS & LOADERS	ROSS CARRIER	X	C	4	7	GR GR	3 3/8 3 3/8	19 3/4 19 3/4	1/4 1/4		A A	N	266246
19 7/8	21 1/4	1 3/4	CHEV/GMC	CELLULAR REPLACEMENT	R	C	3	9	BX BX	2 2	21 3/8 21 3/8	C C		A A	N	226321
19 7/8	21 7/16	2	GM		VT	C	3	12	BX BX	2 2	21 3/8 21 3/8	C C		A A	N	121021
19 7/8	22 9/16	1 1/4	CHRYSLER		VT	C	2	12	BU GR	3 1/2 2 1/4	23 1/8 22 5/8	C C		A A	N	128461
19 7/8	23 1/8	1 3/4	CHEV/GMC	P 50-60 CELLULAR REPLACEMENT	R	C	3	8	BX BX	2 2	23 3/8 23 3/8	C C		A A	N	226336
19 7/8	23 1/8	2 3/8	CHEV/GMC	P 50-60 CELLULAR REPLACEMENT	R	C	4	9	BX BX	2 1/2 2 1/2	23 3/8 23 3/8	C C		A A	N	226337
19 7/8	23 5/8	2 1/4	CHEV/GMC	CELLULAR REPLACEMENT	T	C	3	8	BX BX	2 1/2 2 1/2	23 3/8 23 3/8	C C		A A	N	261022
19 7/8	23 5/8	2	GM		VT	C	3	12	BX BX	2 2	23 5/8 23 5/8	C C		A A	N	121026
19 7/8	23 5/8	2 5/8	GM		VT	C	4	12	BX BX	3 3	23 3/8 23 3/8	C C		A A	N	121027
20	13 1/2	3	LIFT TRUCKS & LOADERS	TOWMOTOR	T	C	4	9	GR GR	3 1/8 3 1/8	14 14	C C		A A	N	279634
20	13 3/4	2 15/16	LIFT TRUCKS & LOADERS	TOWMOTOR	Z	C	4	11	SQ SQ	3 1/8 3 1/8	14 14	C C		A A	N	286580
20	16 7/8	2 1/4	JOHN DEERE	440A	X	C	3	7	BL BL	5 1/2 5 1/2	18 5/16 18 5/16	1 3/4 1 3/4	20 20	B B	C	281935
20	17 5/8	2	FORD		VT	C	3	12	GR GR	2 5/8 2 5/8	17 7/16 17 7/16	C C		A A	N	122503
20	18	2 1/4	LIFT TRUCKS & LOADERS	CLARK	T	C	3	9	GR GR	5 7/8 3 1/2	19 3/4 19 3/4	1/4 1/4		A A	N	260119
20	18 1/8	2 15/16	JOHN DEERE	440A	Z	C	4	8	GR GR	3 1/4 3 1/4	18 3/4 18 3/4	C C		A A	N	225464
20	18 9/16	2 1/4	JOHN DEERE	440	T	C	3	7	GR GR	3 1/4 3 1/4	18 3/4 18 3/4	C C		A A	N	223194
20	18 9/16	3	JOHN DEERE	440	T	C	4	7	GR GR	3 1/4 3 1/4	18 3/4 18 3/4	C C		A A	N	223195
20	18 3/4	2 3/16	JOHN DEERE	440	Z	C	3	9	GR GR	3 1/4 3 1/4	18 3/4 18 3/4	C C		A A	N	289058
20	18 3/4	2 1/4	AJAX	6 1/2 X 8	X	C	3	8	GR GR	5 5	20 20	1/4 1/4		A A	N	221427
20	18 3/4	2 3/8	AJAX		R	C	4	8	GR GR	5 5	20 20	FF FF		A A	N	221472
20	18 3/4	3	JOHN DEERE	SKIDDER	X	C	4	8	GR GR	3 1/4 3 1/4	18 3/4 18 3/4	C C		A A	N	286641
20	19 3/8	2 3/16	HOBART WELDER		Z	C	3	9	GR GR	4 4	19 7/8 19 7/8	3/16 3/16		A A	N	289533

Vista-Pro Automotive - Core Catalog
(Cores Sorted by Size)

Height	Width	Depth	Application	Description	Fin Type	Fin Matl	Rows	FPI	BH / TH Type	BH / TH Width	BH / TH Length	BH / TH OHF	BH / TH Bolts	BH / TH Shape	Hdr Support	Model #
20	20	2 1/4	HOBART WELDER		X	C	3	8	BL BL	6 1/4 6 1/4	23 23	1 1/4 1 1/4	30 30	F F	C	280445
20	20 1/4	2 1/4	HOBART WELDER		T	C	3	8	BL BL	6 1/4 6 1/4	23 23	C C	30 30	F F	C	223269
20	20 1/4	3	HOBART WELDER		T	C	4	8	BL BL	6 1/4 6 1/4	23 23	C C	30 30	F F	C	223270
20	21 7/16	2	GM		VT	C	3	12	BX BX	2 1/4 2 1/4	21 3/8 21 3/8	C C		A A	N	128482
20	23	3 3/4	FIAT ALLIS	COTTON PICKER BRASS FINS	B	B	5	6	GR GR	4 4	23 3/4 23 3/4	C C		A A	N	278614
20	23 1/8	2	GM		VT	C	3	12	BX BX	2 1/2 2 1/2	23 1/2 23 1/2	C C		A A	N	128316
20	23 1/8	3 11/16	FIAT ALLIS	COTTON PICKER	Z	C	5	9	GR GR	4 3/8 4 3/8	23 3/4 23 3/4	C C		A A	N	286662
20	23 1/8	3 11/16	FIAT ALLIS	BALDWIN GLEANER	Z	C	5	7	GR GR	4 4	23 3/4 23 3/4	C C		A A	N	289865
20	23 5/8	2 1/4	FORD	LIGHT TRUCK	T	C	3	8	BU GR	4 3/4 3	24 1/2 24	C C		A A	N	266093
20	23 5/8	1 1/4	FORD		VT	C	2	12	BU GR	4 3/4 3	24 1/2 24	C C		A A	N	128600
20	23 5/8	2 5/8	GM		VT	C	4	12	BX BX	2 5/8 2 5/8	23 5/8 23 5/8	C C		A A	N	128478
20	23 5/8	2 5/8	FORD		VT	C	4	12	BU GR	4 3/4 3	24 5/8 24 1/8	C C		A A	N	122424
20	23 3/4	1 3/4	FORD TRUCK	F350-600 BKT T/HDR RD INL CTRD	R	C	3	7	BU GR	4 3/4 3	24 5/8 24 1/8	1 3/4 C		A A	N	226457
20	23 3/4	2 3/8	FORD TRUCK	F600 BKT T/HDR RD INL CTRD	R	C	4	8	BU GR	4 3/4 3	24 5/8 24 1/8	1 3/8 C		A A	N	226458
20	24 3/16	2 1/4	FORD TRUCK	F35-600 BKT T/HDR 1 1/2" INL CTRD	T	C	3	10	BU GR	4 3/4 3	24 5/8 24 1/8	C C		A A	N	261187
20	24 3/16	2	FORD		VT	C	3	12	BU GR	4 3/4 3	24 1/2 24	C C		A A	N	122251
20	24 3/16	2	FORD		VT	C	3	12	BU GR	4 3/4 3	24 5/8 24 1/8	C C		A A	N	122256
20	26 15/16	2	CHRYSLER		VT	C	3	14	GR GR	2 1/2 2 1/2	27 1/4 27 1/4	1/4 1/4		A A	N	124974
20 1/16	12 3/8	1 9/16	PORSCHE		VE	C	3	16	GR GR	1 3/4 1 3/4	12 3/8 12 3/8	C C		A A	N	122685
20 1/16	25 5/16	2	GM		VT	C	3	12	GR GR	3 2 3/4	25 7/16 25 7/16	C C		A A	N	122271
20 1/8	15 3/4	3 3/4	INT'L HARVESTER	606 DIESEL	T	C	5	10	GR GR	7 1/4 4 1/4	17 1/2 17 1/2	3/8 3/8		A A	N	264031
20 1/8	16 1/4	3	INT'L HARVESTER	606 DIESEL	X	C	4	9	GR GR	7 1/8 3 7/8	17 5/8 15 5/8	3/8 3/8		A A	N	275011
20 1/8	16 1/4	3	JOHN DEERE	450, 550	X	C	4	8	GR GR	4 1/2 4 1/2	16 1/2 16 1/2	C C		A A	N	221234
20 1/8	16 1/4	4 7/16	JOHN DEERE	MODEL 450C AT39009 BRASS FINS	Z	B	6	8	GR GR	4 3/4 4 3/4	16 1/2 16 1/2	C C		A A	N	225466
20 1/8	16 1/4	4 7/16	JOHN DEERE	450C CRAWLER AT116777	S	C	8	8	GR GR	4 3/4 4 3/4	16 1/2 16 1/2	C C		A A	N	229018
20 1/8	16 1/4	4 5/8	JOHN DEERE		X	C	6	8		4 3/4 4 3/4	16 1/2 16 1/2	C C		0 0	N	266437
20 1/8	18 3/4	2 15/16	AJAX		Z	C	4	7	GR GR	5 5	20 20	3/16 3/16		A A	N	225260
20 1/8	19 3/8	2 3/16	JOHN DEERE	350	Z	C	3	7	GR GR	3 1/4 3 1/4	19 7/8 19 7/8	C C		A A	N	225467
20 1/8	19 3/8	2 3/8	DIVCO	240, 300 C528175	R	C	4	8		3 1/4 3 1/4	19 7/8 19 7/8	1/2 1/2		0 0	N	226129
20 1/8	19 3/8	2 15/16	JOHN DEERE	350 RE20981	Z	C	4	7	GR GR	3 1/4 3 1/4	19 7/8 19 7/8	C C		A A	N	225468
20 1/8	19 3/8	3	JOHN DEERE	880	X	C	4	6	GR GR	3 1/4 3 1/4	19 7/8 19 7/8	C C		A A	N	266441
20 1/8	19 11/16	3	LIFT TRUCKS & LOADERS	HYSTER	T	C	4	9	GR GR	4 4	19 7/8 19 7/8	C C		A A	N	279635

Vista-Pro Automotive - Core Catalog
(Cores Sorted by Size)

Height	Width	Depth	Application	Description	Fin Type	Fin Matl	Rows	FPI	BH / TH Type	BH / TH Width	BH / TH Length	BH / TH OHF	BH / TH Bolts	BH / TH Shape	Hdr Support	Model #
20 1/8	20	2 15/16	LIFT TRUCKS & LOADERS	HYSTER	Z	C	4	11	GR GR	4 4	19 7/8 19 7/8	3/16 3/16		A A	N	289937
20 1/8	21	3 3/4	FORD TRUCK	105 TNL CRP/HDRS	B	C	5	8	CR CR	5 1/4 4 1/8	21 1/4 21 1/4	1/4 C		A A	N	268007
20 1/8	21 1/4	3	INT'L HARVESTER	U-6, D-6	X	C	4	7	BL BL	5 1/2 5 1/2	24 3/8 24 3/8	1 1/16 1 1/16	23 23	F F	C	280613
20 1/8	21 3/8	3	DRESSER INDUSTRIES	TD-6	T	C	4	7	BL BL	5 1/2 5 1/2	24 3/8 24 3/8	C C	22 22	A A	C	223022
20 1/8	22 1/2	2 7/8	LIFT TRUCKS & LOADERS	HYSTER	S	C	5	8	GR GR	3 3/8 4 1/4	23 3/4 23 3/4	C 1/4		A A	N	229007
20 1/8	24 3/16	2 1/4	FORD TRUCK	F350-600 BKT T/HDR 1 1/2" INL 8 1/2" RT	T	C	3	9	BU GR	4 3/4 3	24 5/8 24 1/8	1 3/8 C		A A	N	274290
20 1/4	8 3/4	3 7/16	TRUCK AND BUS HEATER	SUPERIOR 331085	R	C	6	10	GR GR	4 4	8 3/4 8 3/4	C C		A A	N	226722
20 1/4	10 5/8	2 7/8	TRUCK AND BUS HEATER	THOMAS, CARPENTER	R	C	5	11	GR GR	3 3/8 3 3/8	10 3/4 10 3/4	C C		A A	N	226723
20 1/4	13 3/4	2 5/8	JOHN DEERE		VT	C	4	12	GR GR	3 1/4 3 1/4	14 14	C C		A A	N	124768
20 1/4	13 3/4	2 15/16	JOHN DEERE	400 BACKHOE	Z	C	4	9	GR GR	3 1/4 3 1/4	14 14	C C		A A	N	225465
20 1/4	14 1/16	3	JOHN DEERE	400-600	T	C	4	8	GR GR	3 1/4 3 1/4	14 14	C C		A A	N	223196
20 1/4	14 5/16	2 5/8	JOHN DEERE		VT	C	4	12	GR GR	3 1/4 3 1/4	14 14	C C		A A	N	124724
20 1/4	16 1/4	2 15/16	INT'L HARVESTER	340, 460	Z	C	4	10	GR GR	7 1/8 3 3/4	17 3/8 15 5/8	1/2 5/8		A A	N	225459
20 1/4	16 1/4	3 11/16	JOHN DEERE	450B CRAWLER	Z	C	5	7	GR GR	4 3/4 4 3/4	16 5/8 16 5/8	C C		A A	N	225508
20 1/4	16 1/4	3 3/4	JOHN DEERE	450	X	C	5	8	GR GR	4 3/4 4 3/4	16 5/8 16 5/8	C C		A A	N	221816
20 1/4	16 1/4	3 15/16	JOHN DEERE	450	S	C	7	7	GR GR	4 3/4 4 3/4	16 5/8 16 5/8	C C		A A	N	273800
20 1/4	16 1/4	3 15/16	JOHN DEERE	450	S	C	7	7	GR GR	4 1/2 4 1/2	16 5/8 16 5/8	C C		A A	N	273801
20 1/4	16 1/4	4 7/16	JOHN DEERE	450C CRAWLER BRASS FINS	Z	B	6	8	GR GR	4 3/4 4 3/4	16 5/8 16 5/8	C C		A A	N	225494
20 1/4	16 5/16	3 3/4	INT'L HARVESTER	340 CRAWLER	T	C	5	7	GR GR	7 1/8 3 7/8	17 1/2 17 3/8	3/8 3/8		A A	N	279307
20 1/4	16 5/16	4 1/2	JOHN DEERE	450	T	C	6	8	GR GR	4 3/4 4 3/4	16 5/8 16 5/8	C C		A A	N	223613
20 1/4	18 9/16	2 1/4	CHRYSLER INDUSTRIAL		T	C	3	8	GR GR	4 1/8 4 1/8	20 20	1/4 1/4		A A	N	260710
20 1/4	18 9/16	2 1/4	GALION	ROLLER	T	C	3	10	GR GR	4 1/4 4 1/4	20 20	1/4 1/4		A A	N	262996
20 1/4	18 9/16	3	CASE/INTERNATIONAL	400	T	C	4	8	GR BL	6 1/8 3 1/4	19 1/2 19 1/2	1/4 1/4		A A	N	223014
20 1/4	18 9/16	3	DETROIT DIESEL	GENERATOR	T	C	4	8	BL BL	5 3/8 5 3/8	20 1/2 20 1/2	C C	34 34	A A	C	272642
20 1/4	18 9/16	3	FAIRBANKS-MORSE	CONTINENTAL ENGINE	T	C	4	8	GR GR	4 1/8 4 1/8	20 20	1/4 1/4		A A	N	223083
20 1/4	18 3/4	2 3/16	GALION		Z	C	3	10	GR GR	4 1/4 4 1/4	20 20	3/16 3/16		A A	N	287736
20 1/4	19	3	CASE/INTERNATIONAL		B	C	4	6	GR GR	3 1/4 3 1/4	19 3/4 19 3/4	C C		A A	N	277125
20 1/4	19 1/8	2 1/4	LeROI		T	C	3	7		6 3 1/2	20 20	1/4 1/4		0 0	N	260260
20 1/4	19 1/8	3	CASE/INTERNATIONAL		T	C	4	6	GR GR	3 1/4 3 1/4	19 3/4 19 3/4	C C		A A	N	263686
20 1/4	19 1/8	3	SPEED SPRAYER	SPEEDSPRAYER	T	C	4	8	GR GR	4 1/4 4 1/4	20 20	1/4 1/4		A A	N	265367
20 1/4	19 3/8	2 1/4	CONTINENTAL	CEMENT MIXER	X	C	3	8	GR GR	4 1/8 4 1/8	20 20	1/8 1/8		A A	N	270709
20 1/4	19 3/8	2 1/4	LINCOLN ELECTRIC		X	C	3	9	GR FR	3 1/8 2 1/4	19 5/8 19 5/8	C C		A A	N	266044

Vista-Pro Automotive - Core Catalog
(Cores Sorted by Size)

Height	Width	Depth	Application	Description	Fin Type	Fin Matl	Rows	FPI	BH / TH Type	BH / TH Width	BH / TH Length	BH / TH OHF	BH / TH Bolts	BH / TH Shape	Hdr Support	Model #
20 1/4	19 3/8	3 3/4	INT'L HARVESTER	3616 BACK HOE	X	C	5	7	GR	4 1/4	19 1/2	C		A	N	221786
									GR	4 1/4	19 1/2	C	A			
20 1/4	19 11/16	2 1/4	JOHN DEERE	350	T	C	3	8	GR	3 1/4	19 7/8	C		A	N	223197
									GR	3 1/4	19 7/8	C	A			
20 1/4	20 1/4	3	CHRYSLER INDUSTRIAL		T	C	4	8	GR	3 1/2	21 3/8	1/4		A	N	261493
									GR	3 1/2	21 3/8	1/4	A			
20 1/4	20 1/4	3	CLETRAC	K12-20	T	C	4	6	BL	6 1/8	24	C	26	J	C	260595
									BL	6 1/8	24	C	26	J		
20 1/4	20 5/8	2 7/8	FORD POWER PRODUCTS		R	C	5	8	CR	7 1/4	17 3/4	3/8		A	N	226454
									CR	4 1/2	21 1/2	3/16	A			
20 1/4	21 3/8	3	FORD POWER PRODUCTS		T	C	4	10	CR	5 1/4	21 5/8	1/4		A	N	223135
									CR	4 1/4	21 5/8	1/4	A			
20 1/4	22	1 1/4	DODGE		VT	C	2	12	BU	4	22 1/4	C		A	N	122396
									GR	2	21 3/4	C	A			
20 1/4	22	1 1/4	DODGE		VT	C	2	12	BU	4	22 1/4	1/4		A	N	122506
									GR	2	21 3/4	1/4	A			
20 1/4	22	2	CHRYSLER		VT	C	3	12	BU	4	22 1/4	C		A	N	128665
									FR	2 1/8	21 3/4	C	A			
20 1/4	22	2	DODGE		VT	C	3	12	BU	4	22 1/4	C		A	N	124590
									GR	2 3/4	21 3/4	C	A			
20 1/4	22	2 5/8	CHRYSLER		VT	C	4	12	BU	4	22 1/4	C		A	N	128657
									GR	2 3/4	21 3/4	C	A			
20 1/4	22 1/2	1 3/4	FORD TRUCK		R	C	3	7	BU	5 3/8	22 7/8	C		A	N	281380
									GR	3	22 1/2	C	A			
20 1/4	22 1/2	1 3/4	FORD TRUCK		R	C	3	11	BU	5 3/8	22 7/8	1 11/16		A	N	282110
									GR	3	22 1/2	C	A			
20 1/4	22 1/2	2 1/4	FORD TRUCK		T	C	3	9	BU	5 1/4	22 7/8	C		A	N	223323
									GR	3	22 1/2	C	A			
20 1/4	23 3/4	1 7/8	NAVISTAR		X	C	2	9	GR	2 1/2	24 1/4	C		A	N	263180
									GR	2 1/2	24 1/4	C	A			
20 1/4	23 3/4	2 1/4	NAVISTAR	A 170,180	X	C	3	11	GR	2 1/2	24	C		A	N	266178
									GR	2 1/2	24	C	A			
20 1/4	24 3/16	2 1/4	NAVISTAR		T	C	3	9	GR	2 1/2	24	C		A	N	261322
									GR	2 1/2	24	C	A			
20 1/4	25 5/16	3	STUDEBAKER TRUCK		T	C	4	8	GR	3 7/8	25 1/2	1/4		0	N	261181
									GR	3 3/8	25 1/2	1/4	0			
20 1/4	25 5/8	2 3/8	FORD TRACTOR	4750 89178	S	C	4	8	GR	4 1/4	26 5/8	1/4		A	N	229049
									GR	4 1/4	26 5/8	1/4	A			
20 1/4	26 1/4	4 7/16	LIFT TRUCKS & LOADERS	TAYLOR BRASS FINS	Z	B	6	10	GR	5	27	C		A	N	286948
									GR	5	27	C	A			
20 5/16	20 7/8	2	FORD		VT	C	3	12	GR	3	21	7/16		A	N	122304
									GR	3	21	7/16	A			
20 5/16	22 1/2	2 1/4	FORD	LIGHT TRUCK	T	C	3	8	BU	5 3/8	23	C		A	N	260713
									GR	3	22 1/2	C	A			
20 5/16	22 1/2	2 1/4	FORD	LIGHT TRUCK	T	C	3	8	BU	5 3/8	23	C		A	N	264055
									GR	3	22 1/2	C	A			
20 5/16	22 9/16	2	FORD		VT	C	3	12	BU	5 3/8	23	C		A	N	122334
									GR	3	22 1/2	C	A			
20 5/16	22 9/16	2	FORD		VT	C	3	12	BU	5 3/8	23	C		A	N	122212
									GR	3	22 1/2	C	A			
20 5/16	22 1/2	3	FORD TRUCK	F500-600 BKT T/HDR 1 1/4" INL CTRD	T	C	4	10	BU	5 3/8	23	C		A	N	264056
									GR	3	22 1/2	C	A			
20 5/16	22 9/16	2 5/8	FORD		VT	C	4	12	BU	5 3/8	23	C		A	N	122420
									GR	3	22 1/2	C	A			
20 3/8	12 5/8	1 1/4	SAAB		VT	C	2	16	GR	1 3/4	13 5/16	C		A	N	128205
									GR	1 3/4	13 5/16	C	A			
20 3/8	14 7/8	1 1/4	BUICK		VT	C	2	16	GR	2 3/4	16 1/2	3/8		A	N	124830
									GR	2 1/16	16 1/2	3/8	A			
20 3/8	14 7/8	1 1/4	CHEVROLET		VT	C	2	16	GR	2 3/4	16 1/2	3/16		A	N	124731
									GR	2 3/4	16 1/2	3/16	A			
20 3/8	14 7/8	2	BUICK		VT	C	3	12	GR	2 3/4	16 1/2	C		A	N	124732
									GR	2 3/4	16 1/2	C	A			
20 3/8	14 7/8	2 5/8	GM		VT	C	4	16	GR	2 7/8	16 1/2	C		A	N	128460
									GR	2 7/8	16 1/2	C	A			

Vista-Pro Automotive - Core Catalog
(Cores Sorted by Size)

Height	Width	Depth	Application	Description	Fin Type	Fin Matl	Rows	FPI	BH / TH Type	BH / TH Width	BH / TH Length	BH / TH OHF	BH / TH Bolts	BH / TH Shape	Hdr Support	Model #
20 3/8	15 5/8	2 7/8	INT'L HARVESTER	340D 377090-R92	S	C	5	7	GR	7 1/8	17 3/8	3/8		A	N	229092
									GR	3 3/4	15 3/4	C		A		
20 3/8	15 3/4	3	INT'L HARVESTER	460	T	C	4	7	GR	7 1/8	17 3/8	3/8		SP	N	223199
									GR	3 3/4	15 3/4	5/8		A		
20 3/8	15 3/4	3 3/4	INT'L HARVESTER	405, 606	T	C	5	10	GR	7 1/8	17 3/8	1/4		A	N	263213
									GR	3 3/4	15 3/4	C		A		
20 3/8	18 3/4	2 1/4	LIFT TRUCKS & LOADERS	CLARK	X	C	3	8	GR	5 7/8	19 3/4	1/4		A	N	266390
									GR	3 7/16	19 3/4	1/4		A		
20 3/8	19 3/8	2 7/8	INT'L HARVESTER	TX47 400941-R1, 65426-C1	S	C	5	7	GR	4 1/4	19 5/8	C		A	N	229093
									GR	4 1/4	19 5/8	C		A		
20 3/8	19 3/8	2 15/16	INT'L HARVESTER	F20 P20 T20	Z	C	4	7	BL	5 1/4	22	1 1/8	28	F	C	280493
									BL	5 1/4	22	1 1/8	28	F		
20 3/8	19 3/8	3	FORD POWER PRODUCTS	403	X	C	4	8	GR	3 7/8	20	1/4		A	N	221502
									GR	3 7/8	20	1/4		A		
20 3/8	19 3/8	3 7/16	INT'L HARVESTER	656 396352-R91, 391200-R91	S	C	6	9	GR	4 1/4	19 5/8	C		A	N	229094
									GR	4 1/4	19 5/8	C		A		
20 3/8	19 1/2	3	FORD POWER PRODUCTS		B	C	4	7	GR	3 7/8	20	3/16		A	N	229514
									GR	3 7/8	20	3/16		A		
20 3/8	19 11/16	3 3/4	INT'L HARVESTER	706D	T	C	5	7	GR	4 1/4	19 3/4	C		A	N	223178
									GR	4 1/4	19 3/4	C		A		
20 3/8	20 5/8	2 1/4	CATERPILLAR		X	C	3	6	BL	4 1/8	22 7/8	C	24	SS	C	265971
									BL	4 1/8	22 7/8	C	24	SS		
20 3/8	22	2	CHRYSLER		VT	C	3	12	BU	4	22 1/4	C		A	N	128467
									FR	2 1/4	21 1/2	C		A		
20 3/8	22	2	CHRYSLER		VT	C	3	12	BU	4	22 1/4	C		A	N	128537
									FR	2 1/8	21 1/2	C		A		
20 3/8	23 1/8	2	GM		VT	C	3	12	BU	3 11/16	23 3/4	C		A	N	122238
									GR	2 1/2	23 3/4	C		A		
20 3/8	23 5/8	2	GM		VT	C	3	12	BU	3 11/16	23 3/4	C		A	N	122227
									GR	2 1/2	23 3/4	C		A		
20 3/8	25 5/16	2	GM		VT	C	3	12	BU	3 3/4	25 1/2	C		A	N	122272
									GR	2 1/2	25 7/16	C		A		
20 3/8	25 7/8	1 1/4	FORD		VT	C	2	14	GR	3	26 13/16	C		A	N	124926
									GR	3	26 13/16	C		A		
20 3/8	25 7/8	2	FORD		VT	C	3	12	GR	3	26 13/16	C		A	N	124927
									GR	3	26 13/16	C		A		
20 3/8	26 3/8	1 1/4	FORD TRUCK		VT	C	2	14	GR	3	26	C		A	N	128142
									GR	3	26	C		A		
20 1/2	12 5/8	1 1/4	HONDA		VT	C	2	12	GR	1 3/4	12 7/16	C		A	N	124973
									GR	1 3/4	12 7/16	C		A		
20 1/2	15	2 3/16	CASE/INTERNATIONAL		Z	C	3	7	BL	5 5/8	17 1/2	2 3/8	16	F	C	225324
									BL	5 5/8	17 1/2	2 3/8	16	F		
20 1/2	15	3	CASE/INTERNATIONAL		X	C	4	7	BL	5 5/8	17 1/2	1 1/16	16	F	C	281061
									BL	5 5/8	17 1/2	1 1/16	16	F		
20 1/2	15 3/8	1 1/4	OMNI-HORIZON		VT	C	2	12	GR	2	16 3/8	C		A	N	124998
									GR	2	16 3/8	C		A		
20 1/2	15 3/8	1 1/4	OMNI-HORIZON		VT	C	2	16	GR	2	16 3/8	C		A	N	128790
									GR	2	16 3/8	C		A		
20 1/2	15 3/4	2 1/4	CASE/INTERNATIONAL	D, DC	T	C	3	8	BL	5 5/8	17 1/2	C	16	A	C	270089
									BL	5 5/8	17 1/2	C	16	A		
20 1/2	15 3/4	3	CASE/INTERNATIONAL	D, DC	T	C	4	7	BL	5 5/8	17 1/2	C	16	A	C	279292
									BL	5 5/8	17 1/2	C	16	A		
20 1/2	15 3/4	3 3/4	CASE/INTERNATIONAL		T	C	5	7	BL	5 5/8	17 1/2	C	16	A	C	223274
									BL	5 5/8	17 1/2	C	16	A		
20 1/2	17 7/16	2 1/4	MINNEAPOLIS MOLINE	2066-4 SWEEPER	T	C	3	9	GR	3 1/2	18	C		A	N	279845
									GR	3 1/2	18	C		A		
20 1/2	18 1/8	3	JOHN DEERE	440	X	C	4	11	GR	3 1/4	18 3/4	C		A	N	221519
									GR	3 1/4	18 3/4	C		A		
20 1/2	18 9/16	2 1/4	JOHN DEERE	440	T	C	3	8	GR	3 1/4	18 3/4	C		A	N	263719
									GR	3 1/4	18 3/4	C		A		
20 1/2	18 9/16	2 1/4	LINCOLN ELECTRIC		T	C	3	8	GR	6	20	1/8		A	N	279733
									GR	4 1/4	20	1/8		A		
20 1/2	18 9/16	3	JOHN DEERE		T	C	4	6	GR	3 1/4	18 3/4	C		A	N	278925
									GR	3 1/4	18 3/4	C		A		

Vista-Pro Automotive - Core Catalog
(Cores Sorted by Size)

Height	Width	Depth	Application	Description	Fin Type	Fin Matl	Rows	FPI	BH / TH Type	BH / TH Width	BH / TH Length	BH / TH OHF	BH / TH Bolts	BH / TH Shape	Hdr Support	Model #
20 1/2	18 3/4	3	JOHN DEERE	2510	X	C	4	6	GR GR	3 1/4 3 1/4	18 3/4 18 3/4	C C		A A	N	289769
20 1/2	19 3/8	2 15/16	FORD POWER PRODUCTS		Z	C	4	10	GR GR	3 7/8 3 7/8	20 20	3/16 3/16		A A	N	286883
20 1/2	19 3/8	3	TREE FARMER	CHIPPER	X	C	4	9	GR GR	4 4	20 20	3/16 3/16		A A	N	289885
20 1/2	19 3/8	3 3/4	INT'L HARVESTER	FARMALL 706	X	C	5	7	GR GR	4 1/4 4 1/4	19 3/4 19 3/4	C C		A A	N	221814
20 1/2	20 5/8	2 15/16	FORD TRACTOR	COTTON PICKER	Z	C	4	8	GR GR	5 4 1/4	21 1/4 21 1/4	3/8 3/8		A A	N	287688
20 1/2	20 5/8	3 3/4	FORD TRACTOR		X	C	5	9	CR CR	7 1/4 4 1/4	17 3/4 21 1/4	3/8 C		A A	N	265981
20 1/2	20 13/16	3	LIFT TRUCKS & LOADERS	CLARK 1500, C120	T	C	4	9	GR GR	6 3 1/2	22 22	1/4 1/4		A A	N	223223
20 1/2	20 13/16	3 3/4	FORD TRACTOR	COTTON PICKER	T	C	5	8	GR GR	5 4 1/4	21 1/4 21 1/4	3/8 3/8		A A	N	223153
20 1/2	22 9/16	2	PACKARD		VT	C	3	12	GR GR	3 5/16 2 3/4	23 23	C C		A A	N	128558
20 1/2	23 1/8	1 1/4	GM		VT	C	2	14	BX BX	2 2	23 1/2 23 1/2	C C		A A	N	128311
20 1/2	23 3/4	2 1/4	MASSEY-FERGUSON		X	C	3	7	SQ SQ	4 4	24 24	1 1/4 1 1/4		A A	N	281974
20 1/2	24 3/16	2 1/4	NAVISTAR		T	C	3	8	GR GR	3 1/8 3 1/8	24 24	1/4 1/4		A A	N	261959
20 1/2	24 3/16	3	NAVISTAR	K-7	T	C	4	8	GR GR	3 1/8 3 1/8	24 24	C C		A A	N	261960
20 1/2	25	2 7/8	FIAT ALLIS	840 LOADER 71007924	S	C	5	7	GR GR	4 1/8 4 1/8	25 3/4 25 3/4	C C		A A	N	229188
20 1/2	25	3 7/16	FIAT ALLIS	840 LOADER 73141093	S	C	6	7	GR GR	4 1/8 4 1/8	25 3/4 25 3/4	C C		A A	N	229189
20 9/16	17 5/8	1 1/4	FORD		VT	C	2	12	GR GR	2 1/4 2 1/4	17 7/16 17 7/16	C C		A A	N	122289
20 9/16	17 5/8	2	FORD		VT	C	3	12	GR GR	2 1/4 2 1/4	17 7/16 17 7/16	C C		A A	N	122311
20 5/8	12 13/16	1 9/16	SAAB		VE	C	3	14	GR GR	2 3/8 2 3/8	13 3/8 13 3/8	C C		A A	N	122699
20 5/8	13 3/16	1 1/4	SAAB		VT	C	2	12	GR GR	2 3/8 2 3/8	13 3/8 13 3/8	C C		A A	N	128104
20 5/8	13 3/16	2	SAAB		VT	C	3	14	GR GR	2 3/8 2 3/8	13 3/8 13 3/8	C C		A A	N	124619
20 5/8	18 1/8	3	CASE/INTERNATIONAL	W-12	X	C	4	9	GR SQ	6 3 1/8	19 3/8 19 3/8	3/16 C		A A	N	289922
20 5/8	19 3/8	2 1/4	JOHN DEERE	350	X	C	3	6	GR GR	3 1/4 3 1/4	19 7/8 19 7/8	C C		A A	N	266426
20 5/8	19 3/8	2 3/8	CHEV/GMC	P 50-60 CELLULAR REPLACEMENT	R	C	4	7	BX BX	3 3	19 3/4 19 3/4	C C		A A	N	226338
20 5/8	19 11/16	3	CHEV/GMC	1 1/2 - 2 TON CELLULAR REPLACEMENT	T	C	4	9	BX BX	3 3	19 5/8 19 5/8	C C		A A	N	223075
20 5/8	20	1 3/4	CHEV/GMC	P 50-60 CELLULAR REPLACEMENT	R	C	3	7	BX BX	2 2	19 3/4 19 3/4	C C		A A	N	226339
20 5/8	21 1/4	1 3/4	INGERSOLL-RAND	SD40 59878819	S	C	3	8	GR GR	3 7/16 3 7/16	21 15/16 21 15/16	1/8 1/8		A A	N	229080
20 5/8	21 1/4	2 7/8	CATERPILLAR	PAVER 5E9014	S	C	5	9	GR GR	3 7/16 3 7/16	21 7/8 21 7/8	C C		A A	N	229174
20 11/16	19 13/16	2	GM		VT	C	3	12	BX BX	2 2	19 11/16 19 11/16	C C		A A	N	122028
20 11/16	19 13/16	2	GM		VT	C	3	12	BX BX	2 2	19 11/16 19 11/16	C C		A A	N	128667
20 11/16	19 13/16	2 5/8	GM		VT	C	4	12	BX BX	2 5/8 2 5/8	19 11/16 19 11/16	C C		A A	N	128477
20 11/16	19 13/16	1 1/4	GM		VT	C	2	14	GR GR	2 2	19 11/16 19 11/16	C C		A A	N	128302
20 11/16	19 13/16	2 5/8	GM		VT	C	4	12	BX BX	3 3	19 11/16 19 11/16	C C		A A	N	122029

Vista-Pro Automotive - Core Catalog
(Cores Sorted by Size)

Height	Width	Depth	Application	Description	Fin Type	Fin Matl	Rows	FPI	BH / TH Type	BH / TH Width	BH / TH Length	BH / TH OHF	BH / TH Bolts	BH / TH Shape	Hdr Support	Model #
20 3/4	10 5/8	3 7/16	TRUCK AND BUS HEATER	WARD	R	C	6	11		4 1/8 4 1/8	10 3/4 10 3/4	C C		0 0	N	226724
20 3/4	11 1/4	2 7/8	TRUCK AND BUS HEATER	WAYNE	R	C	5	11	FR FR	3 3	11 11	C C		0 0	N	226725
20 3/4	11 9/16	1 1/4	VEGA		VT	C	2	13	GR GR	2 2 3/4	13 3/16 13 3/16	C C		A A	N	124563
20 3/4	11 9/16	2	GM		VT	C	3	12	GR FR	2 3/4 2	13 1/4 13 1/4	C C		A A	N	122313
20 3/4	11 9/16	2 5/8	GM		VT	C	4	12	GR GR	2 3/4 2 3/4	13 3/16 13 3/16	C C		A A	N	122613
20 3/4	15 3/8	2 5/8	GM		VT	C	4	12	GR GR	3 5/16 3 5/16	16 11/16 16 11/16	1/4 1/4		A A	N	122438
20 3/4	16 15/16	1 9/16	GM		VE	C	3	14	GR GR	2 3/4 2 3/4	18 5/8 18 5/8	C C		A A	N	128731
20 3/4	17 1/16	1 1/4	CHEVROLET		VT	C	2	12	GR GR	2 3/4 2 3/4	18 5/8 18 5/8	C C		A A	N	122411
20 3/4	17 1/16	1 1/4	CHEVROLET		VT	C	2	13	GR GR	2 1/16 2 3/4	18 5/8 18 5/8	C 7/16		A A	N	124953
20 3/4	17 1/16	2	BUICK		VT	C	3	12	GR GR	2 3/4 2 3/4	18 5/8 18 5/8	C C		A A	N	122413
20 3/4	17 1/16	2	GM		VT	C	3	12	GR GR	2 1/16 2 3/4	18 5/8 18 5/8	C C		A A	N	128619
20 3/4	17 1/16	2	GM		VT	C	3	12	GR GR	3 1/2 3 1/2	18 5/8 18 5/8	C C		A A	N	122479
20 3/4	17 1/16	2 5/8	BUICK		VT	C	4	14	GR GR	3 1/2 3 1/2	18 5/8 18 5/8	C C		A A	N	122483
20 3/4	17 1/16	2 5/8	GM		VT	C	4	12	GR GR	2 3/4 2 3/4	18 5/8 18 5/8	C C		A A	N	122604
20 3/4	17 3/8	1 9/16	GM		VE	C	3	16	GR GR	2 1/16 2 3/4	18 5/8 18 5/8	3/8 3/8		A A	N	128707
20 3/4	18 1/8	2 7/8	FORD TRACTOR	L780 SKIDDER 9603478	S	C	5	8	GR GR	4 4	18 5/16 18 5/16	1/4 1/4		A A	N	229050
20 3/4	18 1/8	3	FORD TRACTOR	L785	X	C	4	9	GR GR	4 4	18 5/16 18 5/16	3/16 3/16		A A	N	282972
20 3/4	18 1/8	3 7/16	FORD TRACTOR	A755 E9NN-8005-BA	S	C	6	9	GR GR	4 4	18 5/8 18 5/8	C C		A A	N	229051
20 3/4	18 9/16	2 1/4	OLIVER HART PARR		T	C	3	9	GR GR	3 1/4 3 1/4	18 3/4 18 3/4	C C		A A	N	279860
20 3/4	18 3/4	2 3/16	OLIVER HART PARR	WHITE	Z	C	3	10	GR GR	3 1/4 3 1/4	18 3/4 18 3/4	C C		A A	N	286613
20 3/4	19 3/8	3 3/4	GM		X	C	5	9	CR CR	4 9/16 3 13/16	19 1/16 19 1/16	3/8 C		A A	N	265920
20 3/4	20 1/4	3	LIFT TRUCKS & LOADERS	CLARK	T	C	4	9	GR GR	3 5/8 3 5/8	22 22	1/4 1/4		A A	N	261712
20 3/4	20 5/8	2 1/4	LIFT TRUCKS & LOADERS	ROSS CARRIER	X	C	3	11	SQ SQ	3 1/2 3 1/2	21 21	3/16 3/16		A A	N	287777
20 3/4	21 1/4	3	LIFT TRUCKS & LOADERS	INTERNATIONAL	X	C	4	10	GR GR	3 1/2 3 1/2	21 3/4 21 3/4	3/16 3/16		A A	N	286598
20 3/4	22	2	GM		VT	C	3	12	BU GR	3 13/16 2 9/16	22 22	C C		A A	N	122230
20 3/4	26 3/8	2	FORD		VT	C	3	12	BU GR	5 3	27 3/8 26 13/16	C C		A A	N	122349
20 3/4	29 1/4	4 1/2	INT'L HARVESTER	4WD TRACTOR	T	C	6	9	GR GR	4 3/4 4 3/4	29 3/4 29 3/4	C C		A A	N	272689
20 13/16	14 7/8	1	TRIUMPH		VE	C	2	16		1 15/16 1 15/16	15 3/4 15 3/4	C C		0 0	N	122431
20 7/8	20 5/8	2 7/8	FORD		S	C	5	8		3 3	21 21	C C		0 0	N	266335
20 7/8	20 5/8	2 15/16	CATERPILLAR	D-4 1S364 HVY T/BTM HDRS	Z	C	4	7	BH BH	5 5/8 5 5/8	23 23	C C	24 24	A A	C	225035
20 7/8	20 5/8	2 15/16	CATERPILLAR	D-4 1S364 HVY T/BTM HDRS HVY STEEL FINS	Z	S	4	7	BH BH	5 5/8 5 5/8	23 23	C C	24 24	A A	C	225801
20 7/8	21	3	CATERPILLAR	D-4 HVY T/BTM HDRS BRASS FINS	B	B	4	7	BH BH	5 5/8 5 5/8	23 23	C C	24 24	A A	C	229581

Vista-Pro Automotive - Core Catalog
(Cores Sorted by Size)

Height	Width	Depth	Application	Description	Fin Type	Fin Matl	Rows	FPI	BH / TH Type	BH / TH Width	BH / TH Length	BH / TH OHF	BH / TH Bolts	BH / TH Shape	Hdr Support	Model #
20 7/8	22 1/2	3	LINCOLN ELECTRIC	300	T	C	4	9	GR	6	23 3/4	1/8		A	N	270594
									GR	4 1/4	23 3/4	1/8		A		
20 7/8	24 3/8	2 7/8	CASE/INTERNATIONAL	W-18	S	C	5	9	GR	4 3/4	25 3/8	1/4		A	N	266275
									GR	4 3/4	25 3/8	1/4		A		
20 7/8	25 7/8	2	CHRYSLER		VT	C	3	12	GR	2 3/4	25 9/16	C		A	N	124778
									GR	2 3/4	25 9/16	C		A		
20 15/16	42 1/2	4 7/16	CATERPILLAR	D353 5L4384 HVY T/BTM HDRS BRASS FINS	Z	B	6	9	BH	8	43 7/8	C	52	A	C	225021
									BH	8	43 7/8	C	52	A		
20 15/16	42 1/2	4 1/2	CATERPILLAR	D353 HVY T/BTM HDRS BRASS FINS FACE DIPPED	B	B	6	7	BH	8	43 7/8	1 1/2	52	A	C	274989
									BH	8	43 7/8	1 1/2	52	A		
21	16 7/8	2 1/4	JOHN DEERE		T	C	3	7	BL	5 1/2	18 3/8	C	20	B	C	278927
									BL	5 1/2	18 3/8	C	20	B		
21	16 7/8	2 1/4	JOHN DEERE	A, 60, 620, 630 HDRS BEVELED	X	C	3	7	BL	5 1/2	18 3/8	1 3/8	20	B	C	282061
									BL	5 1/2	18 3/8	1 3/8	20	B		
21	16 7/8	2 15/16	JOHN DEERE	A, 60, 620, 630 HDRS BEVELED	Z	C	4	6	BL	5 1/2	18 3/8	1 3/8	20	B	C	287561
									BL	5 1/2	18 3/8	1 3/8	20	B		
21	18 11/16	2	DODGE TRK		VT	C	3	12	BU	4	19 1/4	C		A	N	128470
									FR	2 1/8	18 1/2	C		A		
21	19 1/8	3	LIFT TRUCKS & LOADERS	BOBCAT	T	C	4	8	GR	3 3/8	20	1/4		A	N	261724
									GR	3 3/8	20	1/4		A		
21	19 1/4	1 1/4	DODGE TRK		VT	C	2	12	BU	4	19 1/4	C		A	N	124660
									GR	1 3/4	19	C		A		
21	20 5/8	2 1/4	LIFT TRUCKS & LOADERS	PAYLOADER	X	C	3	11	GR	3 1/2	22	3/16		A	N	288777
									GR	3 1/2	22	3/16		A		
21	20 5/8	2 15/16	LIFT TRUCKS & LOADERS	PAYLOADER	Z	C	4	9	SQ	3 1/2	22	3/16		A	N	287702
									SQ	3 1/2	22	3/16		A		
21	20 13/16	3	DRESSER INDUSTRIES	HOUGH	T	C	4	10	GR	3 1/2	22	C		A	N	262966
									GR	3 1/2	22	C		A		
21	21 1/4	2 15/16	LIFT TRUCKS & LOADERS	CLARK BL60	Z	C	4	10	GR	3 3/8	21 7/8	C		A	N	289904
									GR	3 3/8	21 7/8	C		A		
21	21 1/4	3	LIFT TRUCKS & LOADERS	CLARK	X	C	4	9	GR	3 3/8	21 3/4	C		A	N	266183
									GR	3 3/8	21 3/4	C		A		
21	21 3/8	3	LIFT TRUCKS & LOADERS	CLARK	T	C	4	9	GR	3 3/8	21 7/8	C		A	N	279649
									GR	3 3/8	21 7/8	C		A		
21	21 7/8	2 3/16	FIAT ALLIS	HD-5 BRASS FINS	Z	B	3	9	GR	4	22 3/4	3/16		A	N	285000
									GR	2 1/2	22 3/4	3/16		A		
21	21 15/16	2 1/4	FIAT ALLIS	HD-5 BRASS FINS	T	B	3	7	GR	4	22 3/4	1/4		A	N	260117
									GR	2 1/2	22 3/4	1/4		A		
21	22	2 1/4	FIAT ALLIS	HD-5 BRASS FINS FACE DIPPED	B	B	3	6	GR	4	22 3/4	1/8		A	N	274510
									GR	2 1/2	22 3/4	1/8		A		
21	22 1/2	2 7/8	CASE/INTERNATIONAL	870 A-66331	S	C	5	7	GR	3 5/8	23	1/8		A	N	229164
									GR	3 5/8	23	1/8		A		
21	23 1/8	3 11/16	LIFT TRUCKS & LOADERS	INTERNATIONAL	Z	C	5	10	GR	4 1/4	23 3/4	3/16		A	N	286600
									GR	4 1/4	23 3/4	3/16		A		
21	23 1/8	3 3/4	DIEHOE		X	C	5	10	GR	4	23 7/8	C		A	N	266329
									GR	4	23 7/8	C		A		
21	23 3/4	2 3/16	SULLAIR	COMPRESSOR	Z	C	3	10	GR	4	24	3/16		A	N	281854
									GR	4	24	3/16		A		
21	25 7/8	2	DODGE	PICKUP	VT	C	3	14	GR	2 3/4	25 9/16	C		A	N	128282
									GR	2 3/4	25 9/16	C		A		
21	25 7/8	2 5/8	CHRYSLER		VT	C	4	12	GR	2 3/4	25 9/16	C		A	N	128668
									GR	2 3/4	25 9/16	C		A		
21 1/16	21	3	CATERPILLAR	D-4 HVY BTM HDR BRASS FINS	B	B	4	7	BL	5 5/16	27 7/8	C	26	A	C	229659
									BH	5 5/16	27 7/8	C	26	A		
21 1/16	23 1/8	2 7/8	CASE/INTERNATIONAL	475 R-24765	S	C	5	8	GR	3 7/16	23 3/4	C		A	N	229169
									GR	3 7/16	23 3/4	C		A		
21 1/8	15 3/8	1 1/4	TRIUMPH		VT	C	2	16	GR	2 1/4	15 7/8	C		0	N	128454
									GR	2 1/4	15 7/8	C		A		
21 1/8	18 11/16	1 1/4	CHRYSLER		VT	C	2	12	BU	4	19 1/4	C		A	N	122453
									GR	1 3/4	18 1/2	1/8		A		
21 1/8	19 3/8	3	LIFT TRUCKS & LOADERS	BOBCAT	X	C	4	8	GR	3 7/8	19 3/4	3/16		A	N	286727
									GR	3 7/8	19 3/4	3/16		A		
21 1/8	23 1/8	1 1/4	GM		VT	C	2	14	BX	2	23 1/2	C		A	N	128310
									BX	2	23 1/2	C		A		

Vista-Pro Automotive - Core Catalog
(Cores Sorted by Size)

Height	Width	Depth	Application	Description	Fin Type	Fin Matl	Rows	FPI	BH / TH Type	BH / TH Width	BH / TH Length	BH / TH OHF	BH / TH Bolts	BH / TH Shape	Hdr Support	Model #
21 1/8	23 1/8	3 3/4	DYNAHOE		X	C	5	8	GR GR	4 4	23 7/8 23 7/8	C C		A A	N	289594
21 1/8	30 1/4	2	FORD	PICKUP	VT	C	3	12	GR GR	3 3	30 1/2 30 1/2	1/4 1/4		A A	N	124781
21 1/8	30 1/4	2 5/8	FORD		VT	C	4	12	GR GR	3 3	30 1/2 30 1/2	C C		A A	N	128131
21 3/16	18	2 1/4	MINNEAPOLIS MOLINE	UBU	T	C	3	8	BL BL	4 7/8 4 7/8	20 11/16 20 11/16	C C	20 20	F F	C	273448
21 3/16	18 3/4	2 1/4	MINNEAPOLIS MOLINE	UDU	X	C	3	7	BL BL	4 7/8 4 7/8	20 11/16 20 11/16	C C	20 20	F F	C	274471
21 3/16	19 3/8	2 1/4	MINNEAPOLIS MOLINE	KEF-PU	X	C	3	7	BL BL	5 3/8 5 3/8	22 11/16 22 11/16	1 5/16 1 5/16	21 21	J J	C	281461
21 1/4	18 1/8	3 3/4	FORD TRACTOR	BACKHOE	X	C	5	11	GR GR	4 1/8 4 1/8	18 1/2 18 1/2	C C		A A	N	286984
21 1/4	18 9/16	2 1/4	OLIVER HART PARR	1600	T	C	3	9	GR GR	3 1/2 3 1/2	18 3/4 18 3/4	C C		A A	N	279861
21 1/4	18 3/4	2 3/16	OLIVER HART PARR	1600	Z	C	3	9	SQ SQ	3 1/2 3 1/2	18 3/4 18 3/4	C C		A A	N	286360
21 1/4	21 3/8	2 1/4	ONAN		T	C	3	8	GR GR	3 1/2 3 1/2	21 3/4 21 3/4	1/8 1/8		A A	N	272734
21 1/4	22	1 1/4	CHRYSLER		VT	C	2	14	BU GR	4 2	22 1/4 21 3/4	C C		A A	N	128472
21 1/4	22 1/2	2 7/8	LIFT TRUCKS & LOADERS	HYSTER	S	C	5	9	GR GR	3 1/2 3 1/2	23 3/4 23 3/4	C C		A A	N	266223
21 1/4	22 1/2	2 15/16	LIFT TRUCKS & LOADERS	HYSTER	Z	C	4	9	SQ SQ	3 1/2 3 1/2	23 3/4 23 3/4	C C		A A	N	282744
21 1/4	23 1/16	3	CASE/INTERNATIONAL		T	C	4	8	GR GR	3 7/8 3 7/8	23 3/4 23 3/4	C C		A A	N	278773
21 1/4	23 1/8	3	CASE/INTERNATIONAL		X	C	4	8	GR GR	3 7/8 3 7/8	23 3/4 23 3/4	C C		A A	N	289923
21 1/4	24 3/16	3	LIFT TRUCKS & LOADERS	CASE W-14 LOADER	T	C	4	9	GR GR	4 3/4 4 3/4	25 3/8 25 3/8	3/16 3/16		A A	N	265905
21 1/4	24 3/8	3	CASE/INTERNATIONAL	W-18 LOADER	X	C	4	9	GR GR	4 3/4 4 3/4	25 1/4 25 1/4	1/4 1/4		A A	N	221824
21 3/8	12 5/8	2	VOLKSWAGEN		VT	C	3	14		2 3/16 2 3/16	12 11/16 12 11/16	C C		0 0	N	128491
21 3/8	19 3/8	2 3/16	LINCOLN ELECTRIC	DIX 40-250 AMP	Z	C	3	10	GR GR	3 1/8 2 3/8	19 3/4 19 3/4	3/16 3/16		A A	N	287742
21 3/8	19 3/8	2 3/16	MINNEAPOLIS MOLINE	5 STAR	Z	C	3	9	GR BL	3 3/8 5	19 7/8 21 7/8	15/16 1 3/4	22	A F	C	287465
21 3/8	19 11/16	2 1/4	LINCOLN ELECTRIC	250-300 AMP	T	C	3	9	GR FR	3 1/8 2 1/4	19 3/4 19 3/4	1/8 C		A A	N	274436
21 3/8	19 11/16	2 1/4	MINNEAPOLIS MOLINE	HVY BTM HDR	T	C	3	9	SQ BH	3 3/8 5	19 7/8 21 7/8	1 1 5/8	22	A F	C	261731
21 3/8	19 13/16	1 1/4	LINCOLN ELECTRIC	WELDER	VT	C	2	12	GR GR	3 3/8 2 3/8	19 5/8 19 5/8	3/8 C		A A	N	124958
21 3/8	19 13/16	2	WORTHINGTON		VT	C	3	12	GR GR	3 1/8 2 5/16	19 5/8 19 5/8	1/4 C		A A	N	124667
21 3/8	21 3/8	2 1/4	FORD		T	C	3	8	GR GR	3 3	21 21	7/16 7/16		A A	N	260799
21 3/8	24 3/4	2 1/4	JOHN DEERE	COTTON PICKER	T	C	3	7	GR GR	6 3 1/2	25 3/4 25 3/4	1/8 1/8		A A	N	278929
21 1/2	13 3/4	2 15/16	JOHN DEERE	4110	Z	C	4	9	GR GR	3 1/4 3 1/4	14 14	C C		A A	N	225469
21 1/2	13 3/4	3	JOHN DEERE	410	X	C	4	9	GR GR	3 1/4 3 1/4	14 14	C C		A A	N	260761
21 1/2	15	1 3/4	TRIUMPH		R	C	3	11	GR GR	2 3/8 2 3/8	16 16	C C		A A	N	266373
21 1/2	15 3/8	2	TRIUMPH		VT	C	3	12	GR GR	2 3/8 2 3/8	16 16	C C		A A	N	124875
21 1/2	18 1/8	3	CASE/INTERNATIONAL	830	X	C	4	10	GR GR	3 1/4 3 1/4	18 3/8 18 3/8	C C		A A	N	221801
21 1/2	18 1/8	3	OLIVER HART PARR	1650-OL	X	C	4	10	SQ SQ	3 3	19 19	C C		A A	N	265983

Vista-Pro Automotive - Core Catalog
(Cores Sorted by Size)

Height	Width	Depth	Application	Description	Fin Type	Fin Matl	Rows	FPI	BH / TH Type	BH / TH Width	BH / TH Length	BH / TH OHF	BH / TH Bolts	BH / TH Shape	Hdr Support	Model #
21 1/2	18 9/16	3	OLIVER HART PARR	CRAWLER	T	C	4	8	GR GR	3 1/4 3 1/4	19 19	C C		A A	N	277207
21 1/2	18 3/4	2 1/4	JOHN DEERE	G-4251-12,999	X	C	3	7	BL BL	5 3/4 5 3/4	21 1/2 21 1/2	1 3/8 1 3/8	22 22	A A	C	280655
21 1/2	18 3/4	2 7/8	OLIVER HART PARR	CRAWLER	S	C	5	8	GR GR	3 1/4 3 1/4	19 19	3/16 3/16		A A	N	265982
21 1/2	18 3/4	3	OLIVER HART PARR	1600	X	C	4	9	GR GR	3 1/4 3 1/4	19 19	3/16 3/16		A A	N	289178
21 1/2	19 3/8	1 7/8	JOHN DEERE	720 DIESEL	X	C	2	7	BL BL	5 9/16 5 9/16	21 1/2 21 1/2	C C	20 20	C C	C	288305
21 1/2	19 3/8	2 1/4	JOHN DEERE	G-400	X	C	3	7	BL BL	5 5/8 5 5/8	21 1/2 21 1/2	1 1/4 1 1/4	21 21	C C	C	221818
21 1/2	19 3/8	2 1/4	MINNEAPOLIS MOLINE	M5, M602, M670	X	C	3	9	GR BL	3 3/8 5	19 7/8 21 7/8	13/16 1 5/8		A F	C	288417
21 1/2	19 11/16	2 1/4	JOHN DEERE		T	C	3	7	BL BL	5 9/16 5 9/16	21 1/2 21 1/2	1 5/16 1 5/16	20 20	C C	C	262855
21 1/2	19 11/16	2 1/4	JOHN DEERE	70 DIESEL	T	C	3	7	BL BL	5 5/8 5 5/8	21 1/2 21 1/2	1 1/2 1 1/2	22 22	A A	C	273413
21 1/2	19 13/16	2	ONAN CHIPPER		VT	C	3	12	GR GR	3 2 1/4	19 5/8 19 5/8	3/16 C		A A	N	122671
21 1/2	20	3	JOHN DEERE	G-13000	X	C	4	7	BL BL	5 9/16 5 9/16	21 1/2 21 1/2	1 1/8 1 1/8	20 20	C C	C	287288
21 1/2	21 1/4	3	WAUKESHA		X	C	4	8	GR GR	5 7/8 3 1/4	22 1/16 22 1/16	1/4 C		A A	N	286629
21 1/2	23 5/8	2	FORD TRACTOR		VT	C	3	16	GR GR	3 3	24 24	C C		A A	N	128474
21 1/2	23 3/4	2 1/4	JOHN DEERE	COMBINE	X	C	3	6	GR GR	6 3 1/2	25 3/4 25 3/4	1/2 1/2		A A	N	288095
21 1/2	25	3 11/16	JOHN DEERE	699	Z	C	5	7	GR GR	4 1/4 4 1/4	25 3/4 25 3/4	C C		A A	N	289374
21 1/2	25	3 3/4	JOHN DEERE	699	X	C	5	6	GR GR	4 1/4 4 1/4	25 3/4 25 3/4	C C		A A	N	278933
21 1/2	25 5/8	4 5/8	JOHN DEERE	COMBINE	X	C	6	6	GR GR	5 7/8 5 7/8	25 3/4 25 3/4	C C		A A	N	266307
21 9/16	23 1/16	2 1/4	SULLAIR		T	C	3	9	GR GR	3 3	24 24	C C		A A	N	223278
21 5/8	17 1/2	2 7/8	CASE/INTERNATIONAL	830	S	C	5	8	GR GR	3 1/4 3 3/4	18 3/8 18 3/8	C C		A A	N	266273
21 5/8	18 9/16	3	CASE/INTERNATIONAL	730, 740, 830	T	C	4	9	GR GR	6 1/8 3 3/8	19 5/8 19 5/8	1/4 1/4		A A	N	262944
21 5/8	18 9/16	3	CASE/INTERNATIONAL		T	C	4	7	GR GR	3 1/4 3 1/4	18 5/8 18 5/8	C C		A A	N	277345
21 5/8	18 3/4	3	CASE/INTERNATIONAL	830, 840, 900	X	C	4	8	GR GR	6 3 3/8	19 5/8 19 5/8	3/16 C		A A	N	221827
21 5/8	19 13/16	1 1/4	FORD TRUCK		VT	C	2	14	GR GR	2 3/4 2 3/4	20 3/4 20 3/4	1/4 1/4		A A	N	124988
21 5/8	19 13/16	2	FORD		VT	C	3	12	GR GR	2 3/4 2 3/4	20 3/4 20 3/4	C C		A A	N	128108
21 5/8	20 13/16	2 1/4	FORD TRUCK	6 & 8	T	C	3	9	GR GR	3 3	21 21	1/8 1/8		A A	N	271925
21 5/8	20 13/16	2 1/4	FORD		T	C	3	8	GR GR	3 3	21 21	1/4 1/4		A A	N	261925
21 5/8	20 13/16	3	FORD TRUCK	3/4 -2 TON	T	C	4	10	FR FR	3 3	21 21	C C		A 0	N	223202
21 5/8	20 7/8	2	FORD		VT	C	3	12	GR GR	3 3	21 21	1/4 1/4		A A	N	122324
21 5/8	20 7/8	2 5/8	FORD		VT	C	4	12	GR GR	3 3	21 21	C C		A A	N	122333
21 5/8	22	1 1/4	INTERNATIONAL		VT	C	2	12	GR GR	2 3/4 2 3/4	22 22	1/4 1/4		A A	N	124657
21 5/8	22	2	INTERNATIONAL		VT	C	3	12	GR GR	2 3/4 2 3/4	22 22	C C		A A	N	124764
21 5/8	23 1/8	2 3/16	SULLAIR		Z	C	3	10	GR GR	3 3	24 24	3/16 3/16		A A	N	289161

Vista-Pro Automotive - Core Catalog
(Cores Sorted by Size)

Height	Width	Depth	Application	Description	Fin Type	Fin Matl	Rows	FPI	BH / TH Type	BH / TH Width	BH / TH Length	BH / TH OHF	BH / TH Bolts	BH / TH Shape	Hdr Support	Model #
21 5/8	23 5/8	2	NISSAN UD TRUCK		VT	C	3	12	GR GR	2 1/2 2 1/2	24 1/8 24 1/8	C C		A A	N	124037
21 5/8	25	1 3/4	DODGE TRK	D400-600	R	C	3	11	GR GR	4 3 1/8	25 3/4 25 3/4	3/4 C		A A	N	226433
21 3/4	13 3/4	2 5/8	JOHN DEERE		VT	C	4	12	GR GR	3 1/4 3 1/4	14 14	C C		A A	N	124769
21 3/4	13 3/4	2 7/8	JOHN DEERE	410	S	C	5	9	GR GR	3 1/4 3 1/4	14 14	C C		A A	N	266431
21 3/4	13 3/4	2 15/16	JOHN DEERE		Z	C	4	10	GR GR	3 1/2 3 1/2	14 14	C C		A A	N	286640
21 3/4	18	2 1/4	FIAT ALLIS	D-19	T	C	3	8	GR GR	5 3/8 2 1/2	18 18	1/4 1/4		A A	N	223619
21 3/4	18	3	FIAT ALLIS	D-19	T	C	4	8	GR GR	5 3/8 4	18 18	3/16 3/16		A A	N	278620
21 3/4	18 1/8	2 15/16	FIAT ALLIS	D-19	Z	C	4	9	GR GR	5 3/8 4	18 18	3/16 3/16		A A	N	289268
21 3/4	18 1/8	2 15/16	LIFT TRUCKS & LOADERS	CLARK LOADER	Z	C	4	10	SQ SQ	6 3 1/8	19 3/8 19 3/8	3/16 1/8		A A	N	287494
21 3/4	18 1/8	1 1/4	FORD		VT	C	2	14	GR GR	2 13/16 3 3/8	18 7/8 18 7/8	1 1		A A	N	124534
21 3/4	18 1/8	2	FORD		VT	C	3	12	GR GR	3 3/8 2 13/16	18 7/8 18 7/8	3/8 C		A A	N	124535
21 3/4	18 1/8	2 5/8	FORD		VT	C	4	12	GR GR	2 13/16 3 3/8	18 7/8 18 7/8	C C		A A	N	122611
21 3/4	19 3/8	2 1/4	LIFT TRUCKS & LOADERS	CLARK	X	C	3	8	GR GR	3 1/2 3 1/2	19 3/4 19 3/4	3/16 3/16		A A	N	282455
21 3/4	21 1/4	4 7/16	CATERPILLAR	910 LOADER 8N4077 BRASS FINS	Z	B	6	9	GR GR	4 7/8 4 7/8	22 1/8 22 1/8	C C		A A	N	225129
21 3/4	21 1/4	4 5/8	CATERPILLAR	910 LOADER 8N4077	X	C	6	6		4 7/8 4 7/8	22 1/8 22 1/8	C C		0 0	N	266293
21 3/4	21 3/8	4 1/2	CATERPILLAR	910 LOADER	T	C	6	9	GR GR	4 7/8 4 7/8	22 1/8 22 1/8	1/4 1/4		A A	N	265628
21 3/4	21 1/2	4 1/2	CATERPILLAR	910 LOADER 8N4077 BRASS FINS FACE DIPPED	B	B	6	9	GR GR	4 7/8 4 7/8	22 1/8 22 1/8	C C		A A	N	229525
21 3/4	21 1/2	4 1/2	CATERPILLAR	910 LOADER 8N4077 BRASS FINS	B	B	6	9	GR GR	4 7/8 4 7/8	22 1/8 22 1/8	C C		A A	N	229584
21 3/4	25	1 7/8	DODGE TRK	500W	X	C	2	11	GR GR	5 3	25 3/4 25 3/4	1 3/8 3/8		A A	N	288874
21 3/4	25	2 3/8	DODGE TRK	D500-600	R	C	4	10	GR GR	4 3	25 3/4 25 3/4	1/2 C		A A	N	226434
21 3/4	25	2 3/8	DODGE TRK	D500-700	R	C	4	11	GR GR	5 3	25 3/4 25 3/4	C C		A A	N	226435
21 3/4	25	2 15/16	LIFT TRUCKS & LOADERS	CLARK 160B	Z	C	4	11	GR GR	4 4	26 26	3/16 3/16		A A	N	289439
21 3/4	25 5/16	1 1/4	CHRYSLER		VT	C	2	12	GR GR	4 3 1/4	25 3/4 25 3/4	1/4 C		A A	N	124510
21 3/4	25 5/16	2	DODGE TRK		VT	C	3	14	GR GR	5 3	25 3/4 25 3/4	1 1/8 1/4		A A	N	124513
21 3/4	25 5/16	2	DODGE TRK		VT	C	3	12	GR GR	4 3	25 3/4 25 3/4	1/4 1/4		A A	N	128465
21 3/4	25 5/16	2	DODGE TRK		VT	C	3	14	GR GR	5 3	25 3/4 25 3/4	C C		A A	N	128652
21 3/4	25 5/16	2 5/8	DODGE TRK		VT	C	4	12	GR GR	5 3	25 3/4 25 3/4	C C		A A	N	128658
21 3/4	25 5/16	1 1/2	DODGE TRK	D400-600	T	C	2	10	GR GR	4 3	25 3/4 25 3/4	3/4 C		A A	N	223101
21 3/4	25 5/16	2 1/4	DODGE TRK	D400-600	T	C	3	10	GR GR	4 3	25 3/4 25 3/4	3/4 C		A A	N	263308
21 3/4	26 1/4	2 15/16	LIFT TRUCKS & LOADERS	CLARK	Z	C	4	11	GR GR	4 4	26 7/8 26 7/8	3/16 3/16		A A	N	282591
21 3/4	26 7/8	2 7/8	CASE/INTERNATIONAL	W-9 LOADER L-10089	S	C	5	8	GR GR	4 1/4 4 1/4	27 1/4 27 1/4	1/8 1/8		A A	N	229157
21 7/8	18	3 3/4	MASSEY-FERGUSON	1130	T	C	5	9	GR GR	5 1/4 4	18 1/2 18 1/2	3/16 3/16		A A	N	279818

Vista-Pro Automotive - Core Catalog
(Cores Sorted by Size)

Height	Width	Depth	Application	Description	Fin Type	Fin Matl	Rows	FPI	BH / TH Type	BH / TH Width	BH / TH Length	BH / TH OHF	BH / TH Bolts	BH / TH Shape	Hdr Support	Model #
21 7/8	18 1/8	3 11/16	MASSEY-FERGUSON	1130	Z	C	5	9	GR	5 1/4	18 1/2	3/16		A	N	289843
									GR	4	18 1/2	3/16		A		
21 7/8	19 3/8	3	LIFT TRUCKS & LOADERS	HYSTER	X	C	4	10	GR	4	19 3/4	C		A	N	266043
									GR	4	19 3/4	C		A		
21 7/8	19 3/8	3 3/4	LIFT TRUCKS & LOADERS	HYSTER	X	C	5	11	GR	4	19 3/4	C		A	N	266216
									GR	4	19 3/4	C		A		
21 7/8	22 1/2	3	FORD TRUCK	F700-900 BKT T/HDR 1 3/4" INL CTRD	T	C	4	7	BU	5 3/8	23	C		A	N	223156
									GR	3	22 1/2	C		A		
21 7/8	25 5/16	2	DODGE TRK		VT	C	3	12	GR	3 1/4	25 5/8	C		A	N	122635
									GR	3 1/4	25 5/8	C		A		
22	17 1/16	2	GM		VT	C	3	12	GR	3 1/2	18 5/8	3/8		A	N	122576
									GR	3 1/2	18 5/8	3/8		A		
22	17 1/16	2 5/8	CHEV/GMC	CHEV TRK	VT	C	4	12	GR	3 1/2	18 5/8	C		A	N	122584
									GR	3 1/2	18 5/8	C		A		
22	17 7/16	3	MASSEY-FERGUSON		T	C	4	8	GR	4 7/8	18 1/4	C		A	N	279819
									GR	3 1/8	18 1/4	C		A		
22	17 7/16	3 3/4	MASSEY-FERGUSON		T	C	5	9	GR	5	18 1/4	C		A	N	279820
									GR	4	18 1/4	C		A		
22	17 1/2	3 3/4	MASSEY-FERGUSON	1130	X	C	5	9	GR	5	18 1/4	3/16		A	N	286508
									GR	4	18 1/4	3/16		A		
22	18	3 3/4	JOHN DEERE	2010 DIESEL	T	C	5	8	GR	5 1/4	18 5/8	7/8		A	N	275446
									GR	5 1/4	18 5/8	7/8		A		
22	18 1/8	3	MASSEY-FERGUSON	1100	X	C	4	8	GR	5	18 1/2	1/8		A	N	265966
									GR	3 1/4	18 1/2	C		A		
22	19 1/4	1 1/4	INTERNATIONAL		VT	C	2	12	GR	2 1/2	19 3/8	C		A	N	124655
									GR	2 1/2	19 3/8	C		A		
22	19 11/16	3	LIFT TRUCKS & LOADERS	CONTINENTAL LIFT	T	C	4	9	GR	3 1/4	19 3/4	C		A	N	279657
									GR	3 1/4	19 3/4	C		A		
22	21 15/16	3	CUMMINS ENGINE		T	C	4	9	BL	5 3/8	24	C	32	A	C	272837
									BL	5 3/8	24	C	32	A		
22	22	2	DODGE TRK		VT	C	3	12	BU	4	22 5/16	C		A	N	122648
									GR	2 1/2	21 5/8	C		A		
22	22	2	DODGE TRK		VT	C	3	12	BU	4	22 5/16	C		A	N	122705
									GR	2 1/2	21 5/8	C		A		
22	22 1/2	2 1/4	CATERPILLAR	D-3	T	C	3	8	GR	4 3/4	22 3/4	C		A	N	265629
									GR	4 3/4	22 3/4	C		A		
22	22 1/2	3	CATERPILLAR	D-2	T	C	4	8	GR	4 3/4	22 3/4	1/4		A	N	265630
									GR	4 3/4	22 3/4	1/4		A		
22	25 5/8	2 3/8	DODGE TRK		R	C	4	11	GR	3	25 5/8	C		A	N	226131
									GR	2 3/4	25 5/8	C		A		
22	25 7/8	1 1/4	CHRYSLER		VT	C	2	12	GR	3	25 9/16	3/8		A	N	124880
									GR	2	25 9/16	3/8		A		
22	25 7/8	2	DODGE		VT	C	3	12	GR	3	25 9/16	C		A	N	124717
									GR	2 3/4	25 9/16	C		A		
22	26 1/4	6	TIMBER JACK	240A SKIDDER BRASS FINS BAFFLED	Z	B	8	6	GR	6 3/8	26 7/8	C		A	N	282970
									GR	6 3/8	26 7/8	C		A		
22	28 1/16	2	GM		VT	C	3	14	GR	3 1/2	28 3/4	3/8		A	N	128655
									GR	3 1/2	28 3/4	3/8		A		
22	28 11/16	3	CHEV/GMC		T	C	4	9	GR	3 1/2	28 3/4	C		A	N	223076
									GR	3 1/2	28 3/4	C		A		
22 1/8	16 7/8	2 7/8	FORD		S	C	5	8	GR	5 3/4	17 1/8	C		A	N	265934
									GR	3 1/16	17 3/8	C		A		
22 1/8	18	2 1/4	FORD		T	C	3	8	GR	4	17 3/16	FF		A	N	265410
									GR	2 1/4	17 3/16	C		A		
22 1/8	21 1/4	3 3/4	WHITE TRACTOR	FARM TRACTOR	X	C	5	10	GR	6	21 7/8	C		A	N	282661
									GR	4	21 7/8	3/16		A		
22 1/8	21 7/16	2	GM		VT	C	3	12	BU	3 13/16	22	C		A	N	122213
									GR	2 9/16	22	C		A		
22 1/8	22	1 1/4	GM		VT	C	2	14	BX	2	21 7/8	C		A	N	128306
									BX	2	21 7/8	C		A		
22 1/8	22	2	GM		VT	C	3	12	BX	2 1/2	21 7/8	C		A	N	128304
									BX	2 1/2	21 7/8	C		A		

Vista-Pro Automotive - Core Catalog
(Cores Sorted by Size)

Height	Width	Depth	Application	Description	Fin Type	Fin Matl	Rows	FPI	BH / TH Type	BH / TH Width	BH / TH Length	BH / TH OHF	BH / TH Bolts	BH / TH Shape	Hdr Support	Model #
22 1/8	24 3/4	4 1/2	JOHN DEERE	540B SKIDDER	T	C	6	9	GR	5 7/8	25 7/8	C		A	N	223627
									GR	5 7/8	25 7/8	C		A		
22 1/8	25	4 7/16	JOHN DEERE	540B SKIDDER HVY STEEL FINS	Z	S	6	8	GR	5 7/8	25 7/8	3/16		A	N	225945
									GR	5 7/8	25 7/8	3/16		A		
22 3/16	19 1/4	2	INTERNATIONAL		VT	C	3	12	GR	2 1/2	19 3/8	C		A	N	124597
									GR	2 1/2	19 3/8	C		A		
22 1/4	18	2 1/4	JOHN DEERE	3010, 3020 AR46448, AR46019	T	C	3	7	GR	5 1/4	18 7/8	1		A	N	223198
									GR	3 1/4	18 7/8	1		A		
22 1/4	18 1/8	1 3/4	FORD		R	C	3	7	SQ	4 3/8	17 1/8	1/4		0	N	265922
									SQ	2 5/16	17 3/8	1/4		A		
22 1/4	18 1/8	2 3/8	FORD	LIGHT TRUCK	S	C	4	8	GR	4 3/8	17 7/8	1/4		A	N	265933
									GR	2 13/16	17 7/8	C		A		
22 1/4	23 1/8	3 11/16	DYNABOE	190-4	Z	C	5	9	SQ	4 5/16	23 3/4	C		A	N	281648
									SQ	4 5/16	23 3/4	C		A		
22 1/4	24 3/8	2 7/8	CATERPILLAR	D-4 2A684	S	C	5	6	BL	5 3/8	27 1/4	C	28	H	C	229175
									BL	5 3/8	27 1/4	C	28	H		
22 1/4	25 5/16	1 1/4	DODGE TRK		VT	C	2	12	GR	3	25 5/8	1		A	N	122651
									GR	2 3/4	25 5/8	1		A		
22 1/4	26 7/8	2 7/8	FIAT ALLIS	940 LOADER 1005966-05	S	C	5	6	GR	4 1/8	27 1/4	C		A	N	229190
									GR	4 1/8	27 1/4	C		A		
22 5/16	21 15/16	2 1/4	MINNEAPOLIS MOLINE	336 TM-3230B	T	C	3	8	BL	5 7/8	24 5/8	1 5/16	24	A	C	260633
									BL	5 7/8	24 5/8	1 5/16	24	A		
22 3/8	19 1/4	2	STUDEBAKER		VT	C	3	12	GR	2 1/2	19 1/16	C		A	N	122452
									GR	2 1/2	19 1/16	C		A		
22 3/8	22 1/2	2 1/4	MINNEAPOLIS MOLINE	UB 283-GTB-403	T	C	3	7	BL	6	24 3/4	1 3/8	24	F	C	270633
									BL	6	24 3/4	1 3/8	24	F		
22 3/8	22 1/2	2 1/4	MINNEAPOLIS MOLINE	UB 283-GTB-403	X	C	3	9	BL	5 7/8	24 5/8	1 3/16	24	F	C	281456
									BL	5 7/8	24 5/8	1 3/16	24	F		
22 3/8	22 1/2	3	MINNEAPOLIS MOLINE		X	C	4	8	BL	5 7/8	24 5/8	1 3/16	24	F	C	288694
									BL	5 7/8	24 5/8	1 3/16	24	F		
22 3/8	23 1/8	3	LIFT TRUCKS & LOADERS	CLARK	X	C	4	9	GR	3 1/2	23 3/4	3/16		A	N	286950
									GR	3 1/2	23 3/4	3/16		A		
22 3/8	25	3 3/4	JOHN DEERE	95 COMBINE	X	C	5	6	GR	4 3/8	25 7/8	C		A	N	286659
									GR	4 3/8	25 7/8	C		A		
22 7/16	17 5/8	1 1/4	MERCURY		VT	C	2	12	GR	2 1/4	17 7/16	C		A	N	122235
									GR	2 1/4	17 7/16	C		A		
22 7/16	17 5/8	1 1/4	FORD		VT	C	2	12	GR	2 5/8	17 1/2	C		A	N	122348
									GR	2 5/8	17 1/2	C		A		
22 7/16	17 5/8	2	FORD		VT	C	3	12	GR	2 1/4	17 7/16	C		A	N	122338
									GR	2 1/4	17 7/16	C		A		
22 7/16	17 5/8	2	FORD		VT	C	3	12	GR	2 5/8	17 1/2	C		A	N	122350
									GR	2 5/8	17 1/2	C		A		
22 7/16	19 11/16	3	FORD		T	C	4	8		6 1/4	19 5/8	1/4		0	N	261289
										3	19 5/8	C		0		
22 7/16	19 1/8	3	INT'L HARVESTER	FARMALL 460	T	C	4	7	GR	4 1/4	19 3/4	C		A	N	223234
									GR	4 1/4	19 3/4	C		A		
22 7/16	19 1/8	3 3/4	INT'L HARVESTER		T	C	5	8	GR	4 1/4	19 3/4	C		A	N	263953
									GR	4 1/4	19 3/4	C		A		
22 7/16	19 3/8	2 15/16	INT'L HARVESTER	460	Z	C	4	8	GR	4 1/4	19 3/4	C		A	N	288641
									GR	4 1/4	19 3/4	C		A		
22 7/16	19 11/16	3 3/4	INT'L HARVESTER	FARMALL F-560 DIESEL	T	C	5	7	GR	4 1/4	19 7/8	C		A	N	274790
									GR	4 1/4	19 7/8	C		A		
22 1/2	10 5/8	2 7/8	TRUCK AND BUS HEATER	BLUEBIRD 0556050	R	C	5	11		3 1/4	10 5/8	C		0	N	226726
										3 1/4	10 5/8	C		0		
22 1/2	17 1/16	2 5/8	CHEVROLET	CORVETTE	VT	C	4	12	GR	3 1/2	18 5/8	C		A	N	122515
									GR	3 7/16	18 5/8	C		A		
22 1/2	17 1/16	2 5/8	GM		VT	C	4	16	GR	3 1/2	18 5/8	C		A	N	128776
									GR	3 1/2	18 5/8	C		A		
22 1/2	17 5/8	2 5/8	FORD		VT	C	4	12	GR	2 3/4	17 7/16	C		A	N	128613
									GR	2 3/4	17 7/16	C		A		
22 1/2	18 1/8	2 1/4	JOHN DEERE	3010 TRACTOR	X	C	3	6	GR	5 3/8	18 3/4	2 1/4		A	N	221819
									GR	3 3/8	18 3/4	3/16		A		
22 1/2	18 1/8	3	CASE/INTERNATIONAL	930, 940	X	C	4	9	GR	3 1/4	18 3/4	1/8		A	N	266101
									GR	3 1/4	18 3/4	1/8		A		

Vista-Pro Automotive - Core Catalog
(Cores Sorted by Size)

Height	Width	Depth	Application	Description	Fin Type	Fin Matl	Rows	FPI	BH / TH Type	BH / TH Width	BH / TH Length	BH / TH OHF	BH / TH Bolts	BH / TH Shape	Hdr Support	Model #
22 1/2	18 1/8	3	CASE/INTERNATIONAL	930, 940	X	C	4	8	GR GR	3 1/4 3 1/4	18 3/4 18 3/4	C C		A A	N	288696
22 1/2	18 1/8	3	JOHN DEERE	2010 DIESEL	X	C	4	8	GR GR	3 1/4 3 1/4	18 3/4 18 3/4	C C		A A	N	288561
22 1/2	18 1/8	3	JOHN DEERE	3020	X	C	4	8	GR GR	5 3/8 3 3/8	18 3/4 18 3/4	3/16 3/16		A A	N	289130
22 1/2	18 1/8	2 5/8	GM		VT	C	4	12	BX BX	3 3	18 18	C C		A A	N	121442
22 1/2	18 1/2	3	CASE/INTERNATIONAL	930, 940	B	C	4	7	GR GR	3 1/4 3 1/4	18 3/4 18 3/4	3/16 3/16		A A	N	277346
22 1/2	18 9/16	2 1/4	JOHN DEERE	3010 TRACTOR	T	C	3	8	GR GR	5 3/8 3 3/8	18 3/4 18 3/4	7/8 7/8		A A	N	223203
22 1/2	18 9/16	2 1/4	JOHN DEERE	3010 TRACTOR	T	C	3	6	GR GR	5 3/8 3 3/8	18 3/4 18 3/4	3/4 3/4		A A	N	223204
22 1/2	18 9/16	3	JOHN DEERE	3020	T	C	4	8	GR GR	5 3/8 3 3/8	18 3/4 18 3/4	3/16 3/16		A A	N	223205
22 1/2	18 9/16	3	JOHN DEERE	2010 DIESEL	T	C	4	7	GR GR	3 1/4 3 1/4	18 3/4 18 3/4	C C		A A	N	277161
22 1/2	18 9/16	3 3/4	JOHN DEERE	2010 DIESEL	T	C	5	8	GR GR	5 3/8 5 3/8	18 3/4 18 3/4	1/4 1/4		A A	N	263952
22 1/2	18 3/4	2 7/8	JOHN DEERE	G-421	S	C	5	8	GR GR	5 3/8 3 3/8	18 3/4 18 3/4	1/8 C		A A	N	221245
22 1/2	19 1/8	4 1/2	JOHN DEERE	540 SKIDDER	T	C	6	6	GR GR	5 3/8 5 3/8	19 7/8 19 7/8	C C		A A	N	265469
22 1/2	19 1/8	4 1/2	JOHN DEERE	540	T	C	6	8	GR GR	5 3/8 5 3/8	19 7/8 19 7/8	C C		A A	N	278942
22 1/2	19 1/4	2	FORD		VT	C	3	14	GR GR	2 7/8 2 7/8	19 19	C C		A A	N	124645
22 1/2	20 7/8	2	FORD		VT	C	3	12	GR GR	3 3	21 21	1/4 1/4		A A	N	122322
22 1/2	21 3/8	3	WAUKESHA		T	C	4	8	GR GR	5 7/8 3 1/4	22 1/16 22 1/16	1/8 1/8		A A	N	279957
22 1/2	21 7/8	3 11/16	OLIVER HART PARR	OC121956	Z	C	5	8	SQ SQ	6 1/4 4	22 22	1/16 1/16		A A	N	287295
22 1/2	22 1/2	2 1/4	GARDNER DENVER		T	C	3	9	BL BL	4 3/8 4 3/8	26 1/2 26 1/2	C C	28 28	A A	C	272661
22 1/2	23 1/16	3	CASE/INTERNATIONAL		T	C	4	8	GR GR	6 3 1/2	23 3/4 23 3/4	C C		A A	N	223015
22 1/2	23 1/16	3	GALION		T	C	4	9		4 1/4 4 1/4	23 3/4 23 3/4	C C		0 0	N	279213
22 1/2	23 1/8	2 3/8	GALION	CRANE D-77013	S	C	4	10	GR GR	3 1/2 3 1/2	23 3/4 23 3/4	C C		A A	N	229063
22 1/2	23 1/8	2 7/8	GALION	ROLLER D-119223, D-124204	S	C	5	9	GR GR	3 1/2 3 1/2	23 3/4 23 3/4	C C		A A	N	229127
22 1/2	23 1/8	3	GALION		X	C	4	9	GR GR	4 1/4 4 1/4	23 3/4 23 3/4	C C		A A	N	286559
22 1/2	23 1/8	3	GALION	104363	X	C	4	9	GR GR	3 1/2 3 1/2	23 3/4 23 3/4	C C		A A	N	286872
22 1/2	23 5/8	2 1/4	CHEV/GMC	CELLULAR REPLACEMENT	T	C	3	8	BX BX	2 1/2 2 1/2	23 5/8 23 5/8	C C		A A	N	261137
22 1/2	23 5/8	3	GALION	WAUKESHA 150	T	C	4	9	GR GR	3 1/2 3 1/2	23 3/4 23 3/4	C C		A A	N	265509
22 1/2	23 5/8	3	LIFT TRUCKS & LOADERS	TROJAN	T	C	4	9	GR GR	4 4	24 24	1/4 1/4		A A	N	261762
22 1/2	25	2 3/16	JOHN DEERE	SKIDDER	Z	C	3	7	GR GR	4 4	25 1/2 25 1/2	3/16 3/16		A A	N	281862
22 1/2	25	2 1/4	JOHN DEERE		X	C	3	7	GR GR	4 4	25 1/2 25 1/2	3/16 3/16		A A	N	281647
22 1/2	25	3	JOHN DEERE	690	X	C	4	7	GR GR	4 3/8 4 3/8	25 7/8 25 7/8	C C		A A	N	260770
22 1/2	25	3	JOHN DEERE	690 EXPEDITER	X	C	4	8	GR GR	4 3/8 4 3/8	25 7/8 25 7/8	C C		A A	N	289565
22 1/2	25	3 11/16	CASE/INTERNATIONAL	850 BRASS FINS	Z	B	5	8	GR BL	5 1/4 7 1/8	25 27 1/2	3/8 1 1/4	36	A A	C	225616

Vista-Pro Automotive - Core Catalog
(Cores Sorted by Size)

Height	Width	Depth	Application	Description	Fin Type	Fin Matl	Rows	FPI	BH / TH Type	BH / TH Width	BH / TH Length	BH / TH OHF	BH / TH Bolts	BH / TH Shape	Hdr Support	Model #
22 1/2	25	3 3/4	CASE/INTERNATIONAL	880 HVY BTM HDR BRASS FIN FACE DIPPED	B	B	5	7	SQ BH	5 1/4 7 1/8	25 27 3/4	1/4 1 3/8	40	A A	C	277126
22 1/2	25	3 3/4	CASE/INTERNATIONAL	850	X	C	5	8	GR BL	5 1/4 7 1/8	25 27 3/4	1 1/4 2 1/4	40	A A	C	286917
22 1/2	27 1/2	2 7/8	DRESSER INDUSTRIES	1260643-H1	S	C	5	7	GR GR	4 1/4 4 1/4	28 1/4 28 1/4	C C		A A	N	229042
22 5/8	18	2 1/4	CATERPILLAR	D-2 HVY BTM HDR OFFSET FOR O/C	T	C	3	8	BL BH	5 1/4 5 1/4	25 1/4 25 1/4	C C	28 28	H H	C	265631
22 5/8	18	3	CASE/INTERNATIONAL	930	T	C	4	7	GR GR	6 3 1/4	19 3/8 19 3/8	1/8 C		A A	N	274991
22 5/8	18	3	CATERPILLAR	D-2 HVY BTM HDR OFFSET FOR O/C	T	C	4	9	BL BH	5 1/4 5 1/4	25 1/4 25 1/4	C C	28 28	H H	C	265632
22 5/8	18 1/8	2 15/16	CATERPILLAR	D-2 8F3135 HVY T/BTM HDRS OFFSET FOR O/C	Z	C	4	6	BH BH	5 1/4 5 1/4	25 1/4 25 1/4	C C	28 28	H H	C	225026
22 5/8	18 9/16	2 1/4	INT'L HARVESTER	FARMALL A	T	C	3	7	GR GR	7 3 1/2	19 5/8 19 5/8	1/2 1/2		A A	N	223235
22 5/8	18 9/16	2 1/4	INT'L HARVESTER	SUPER M CRP/HDRS	T	C	3	6	CR CR	8 1/2 4 1/4	19 3/4 19 3/4	1/2 1/2		A A	N	223236
22 5/8	18 9/16	2 1/4	INT'L HARVESTER	FARMALL M	T	C	3	7	GR GR	8 1/4 3 3/4	19 5/8 19 3/8	1/2 1/2		A A	N	260251
22 5/8	18 9/16	2 1/4	INT'L HARVESTER	FARMALL M	T	C	3	7	GR GR	8 1/4 3 3/4	19 5/8 19 5/8	9/16 9/16		A A	N	270920
22 5/8	18 9/16	3 3/4	INT'L HARVESTER	M DIESEL CRP/HDRS	T	C	5	7	CR CR	7 1/4 4 1/4	17 3/4 19 3/4	3/8 1/2		A A	N	262163
22 5/8	18 3/4	2 1/4	INT'L HARVESTER	FARMALL M	X	C	3	6	CR CR	8 1/4 3 3/4	19 5/8 19 5/8	1/2 1/2		A A	N	288223
22 5/8	18 3/4	3	INT'L HARVESTER	SUPER M	X	C	4	7	CR CR	8 1/4 3 3/4	19 5/8 19 5/8	3/8 3/8		A A	N	265901
22 5/8	18 3/4	3	INT'L HARVESTER	M CRP/HDRS	X	C	4	6	CR CR	8 1/2 4 1/4	17 3/4 19 3/4	1/2 1/2		A A	N	265902
22 5/8	18 3/4	3	INT'L HARVESTER	FARMALL M CRP HDRS	X	C	4	7	CR CR	8 1/2 4 1/4	19 3/4 19 3/4	9/16 9/16		A A	N	274783
22 5/8	18 3/4	3 7/16	INT'L HARVESTER	FARMALL CRP/HDRS	S	C	6	10	CR CR	8 1/2 4 1/4	19 3/4 19 3/4	1/2 1/2		A A	N	229029
22 5/8	19 3/8	4 7/16	JOHN DEERE	540 BRASS FIN	Z	B	6	6	GR GR	5 3/8 5 3/8	19 7/8 19 7/8	C C		A A	N	289410
22 5/8	20 13/16	3	WAUKESHA	GL-190	T	C	4	8	BL BL	5 3/4 5 3/4	24 24	C C	36 36	A A	C	272531
22 5/8	21 3/8	2 1/4	WAUKESHA	VRG-155, VRD-232	T	C	3	9	GR GR	5 7/8 3 7/16	21 3/4 21 3/4	1/4 1/4		A A	N	272529
22 5/8	21 3/8	3	WAUKESHA	VRD-232	T	C	4	8	GR GR	5 7/16 3 7/16	21 3/4 21 3/4	1/8 1/8		A A	N	272530
22 5/8	22 1/2	2 3/16	CATERPILLAR	933 LOADER 3S9307 HVY T/BTM HDRS	Z	C	3	8	BH BH	4 1/2 4 1/2	25 3/8 25 3/8	C C	24 24	F F	C	225031
22 5/8	22 1/2	2 15/16	CATERPILLAR	922B 1S1386 HVY T/BTM HDRS	Z	C	4	6	BH BH	5 3/8 5 3/8	25 1/8 25 1/8	C C	24 24	F F	C	225036
22 5/8	22 1/2	3	CATERPILLAR	922B HVY BTM HDR	T	C	4	7	BL BH	5 3/8 5 3/8	25 1/8 25 1/8	C C	24 24	A A	C	270103
22 5/8	24 1/2	3	CATERPILLAR	922 LOADER 4M114 HVY BTM HDR BRASS FIN FACE DIPPED	B	B	4	7	BL BH	5 5	26 26	C C	24 24	A A	C	275091
22 5/8	25	2 3/16	PETTIBONE	INTERNATIONAL ENGINE	Z	C	3	6	GR GR	5 1/4 4	25 9/16 25 9/16	1 1/4 1 1/4		A A	N	282586
22 5/8	25 5/16	2 1/4	BARBER-GREENE		T	C	3	8	GR GR	5 1/4 4	25 1/2 25 1/2	1 7/8 1/2		A A	N	223005
22 11/16	25	2 3/8	INT'L HARVESTER	UB220 265595-R93	S	C	4	6	GR GR	5 1/4 4	25 5/8 25 5/8	9/16 1/2		A A	N	229096
22 11/16	25	2 7/8	INT'L HARVESTER	UD236 304608-R93	S	C	5	8	GR GR	5 1/4 4	25 5/8 25 5/8	9/16 C		A A	N	229097
22 11/16	25	3 7/16	INT'L HARVESTER	UD282 610643-C91	S	C	6	9	GR GR	5 1/4 4	25 5/8 25 5/8	9/16 C		A A	N	229098
22 11/16	25 5/16	3	INT'L HARVESTER	UD236 304608-R93	T	C	4	8	GR GR	5 1/4 4	25 5/8 25 5/8	3/8 3/8		A A	N	223237
22 3/4	9 3/8	3	CASE/INTERNATIONAL	LOADER	X	C	4	9		4 4	11 11	1/4 1/4		0 0	N	289429

Vista-Pro Automotive - Core Catalog
(Cores Sorted by Size)

Height	Width	Depth	Application	Description	Fin Type	Fin Matl	Rows	FPI	BH / TH Type	BH / TH Width	BH / TH Length	BH / TH OHF	BH / TH Bolts	BH / TH Shape	Hdr Support	Model #
22 3/4	16 7/8	3	FORD		T	C	4	9	GR GR	7 1/16 3	17 17	1/4 C		A A	N	260348
22 3/4	18	3	CASE/INTERNATIONAL		T	C	4	9	GR GR	3 1/4 3 1/4	18 1/4 18 1/4	C C		A A	N	278782
22 3/4	18 1/8	2 15/16	CASE/INTERNATIONAL	930, 940	Z	C	4	11	GR GR	3 1/4 3 1/4	18 1/4 18 1/4	C C		A A	N	225331
22 3/4	18 11/16	1 1/4	BMW		VT	C	2	12	GR GR	2 1/8 2 1/8	18 1/2 18 1/2	C C		A A	N	124840
22 3/4	18 11/16	1 1/4	BMW		VT	C	2	16	GR GR	2 5/16 2 5/16	18 1/2 18 1/2	3/16 3/16		A A	N	124603
22 3/4	18 11/16	2	BMW		VT	C	3	14		2 5/16 2 5/16	18 1/2 18 1/2	C C		0 0	N	124909
22 3/4	20 13/16	3	WAUKESHA	190	T	C	4	7	BL BL	5 5/8 5 5/8	24 24	C C	36 36	A A	C	266620
22 3/4	21 7/8	2 15/16	WAUKESHA	VRG-310	Z	C	4	10	GR GR	6 3 1/2	22 22	1/4 1/4		A A	N	286909
22 3/4	24 3/4	4 1/2	STEIGER TRACTOR	BEARCAT II	T	C	6	9		4 3/4 4 3/4	25 1/2 25 1/2	C C		0 0	N	265535
22 3/4	31 1/2	4 1/2	MASSEY-FERGUSON	760 COMBINE	T	C	6	6	GR GR	4 3/4 4 3/4	31 3/4 31 3/4	C C		A A	N	265907
22 7/8	18 3/4	3	CASE/INTERNATIONAL	26-40	X	C	4	7	BL BL	6 3/8 6 3/8	22 1/4 22 1/4	C C	18 18	S S	C	274571
22 7/8	19 3/8	3	CASE/INTERNATIONAL	L500	X	C	4	7	BL BL	6 3/8 6 3/8	22 1/4 22 1/4	1 1/4 1 1/4	18 18	S S	C	281440
22 7/8	25	2 7/8	DRESSER INDUSTRIES	515B LOADER 1279581-H91	S	C	5	7	GR GR	4 5/16 4 5/16	25 3/4 25 3/4	C C		A A	N	229128
22 7/8	27 1/2	2 7/8	GARDNER DENVER	185 CFM COMPRESSOR 2014438	S	C	5	9	GR GR	4 1/4 4 1/4	28 1/4 28 1/4	C C		A A	N	229069
23	13 3/16	1 1/4	SUBARU		VT	C	2	14	GR GR	2 7/8 1 7/8	13 1/2 13 1/2	FF C		A A	N	124993
23	15 5/8	3	FORD		X	C	4	8	GR GR	8 1/4 3	15 3/4 15 3/4	1 1/4 C		A A	N	265924
23	15 15/16	1 1/4	PACER		VT	C	2	12	GR GR	2 3/4 2 3/4	17 1/2 17 1/2	C C		A A	N	124759
23	17 1/16	1 1/4	APOLLO		VT	C	2	12	GR GR	2 3/4 2 3/4	18 5/8 18 5/8	3/8 3/8		A A	N	122559
23	17 1/16	2	FIREBIRD		VT	C	3	12	GR GR	2 3/4 2 3/4	18 5/8 18 5/8	C C		A A	N	122530
23	17 1/16	2	GM		VT	C	3	12	GR GR	3 1/2 3 1/2	18 5/8 18 5/8	C C		A A	N	122555
23	17 1/16	2 5/8	PONTIAC		VT	C	4	12	GR GR	3 1/2 3 1/2	18 5/8 18 5/8	C C		A A	N	122558
23	17 1/16	2 5/8	GM		VT	C	4	12	GR GR	2 3/4 2 3/4	18 5/8 18 5/8	C C		A A	N	122607
23	18 9/16	2 1/4	JOHN DEERE		T	C	3	7	GR GR	5 3/8 3 3/8	18 3/4 18 3/4	C 7/8		A A	N	223283
23	19 1/8	3	MASSEY-FERGUSON		T	C	4	8	GR GR	6 3 1/2	19 5/8 19 5/8	3/4 C		A A	N	260690
23	19 3/8	3 3/4	INT'L HARVESTER	1806	X	C	5	7	GR GR	4 3/8 4 3/8	19 3/4 19 3/4	C C		A A	N	221810
23	19 11/16	3	LIFT TRUCKS & LOADERS	CLARK	T	C	4	8	GR GR	3 7/8 3 7/8	19 7/8 19 7/8	3/16 3/16		A A	N	279663
23	20 1/4	2 1/4	FIAT ALLIS	CRAWLER 1" X 2 1/2" ELONGATED HOLE CTRD ON BTM HDR	T	C	3	6	BL BL	7 1/4 5 3/4	23 23	1 5/16 1 5/16	24 22	H F	C	261467
23	20 5/8	2 3/16	FIAT ALLIS	U-40 1" X 2 1/2" ELONGATED HOLE CTRD ON BTM HDR	Z	C	3	8	BL BL	7 1/4 5 3/4	23 23	1 1/4 1 1/8	24 24	J F	C	281467
23	21 3/8	3	WAUKESHA		T	C	4	10	GR GR	6 3 1/2	22 22	1/4 1/4		A A	N	265653
23	23 1/16	2 1/4	GALION	WAUKESHA ENGINE	T	C	3	7	GR GR	4 3/8 4 3/8	24 24	C C		A A	N	279215
23	23 1/16	3 3/4	GALION		T	C	5	9	GR GR	4 3/8 4 3/8	24 24	C C		A A	N	279216
23	23 1/16	4 1/2	SPEED SPRAYER	SOLDER COATED FINIS	T	SC	6	9	GR GR	5 3/8 4 7/8	23 1/4 23 1/4	C C		A A	N	273459

Vista-Pro Automotive - Core Catalog
(Cores Sorted by Size)

Height	Width	Depth	Application	Description	Fin Type	Fin Matl	Rows	FPI	BH / TH Type	BH / TH Width	BH / TH Length	BH / TH OHF	BH / TH Bolts	BH / TH Shape	Hdr Support	Model #
23	23 1/8	1 3/4	KOHLER ENGINES & GEN	50-60 KW A-273412	S	C	3	10	GR	4 1/2	23 15/16	C		A	N	229122
									GR	4 1/2	23 15/16	C		A	N	
23	23 1/8	2 3/8	GALION		S	C	4	9	GR	4 3/8	24	C		A	N	266324
									GR	4 3/8	24	C		A	N	
23	23 1/8	3	GALION		X	C	4	9	GR	4 3/8	24	C		A	N	286560
									GR	4 3/8	24	C		A	N	
23	23 1/2	3 3/4	FIAT ALLIS	880 COTTON STRIPPER	B	C	5	7	GR	4	24	C		A	N	229513
									GR	4	24	C		A	N	
23	23 5/8	2 1/4	JOY MANUFACTURING	COMPRESSOR	T	C	3	10	GR	3 1/8	24	C		A	N	279437
									GR	3 1/8	24	C		A	N	
23	23 5/8	1 1/4	WORTHINGTON		VT	C	2	12	GR	3	24	1/4		A	N	124669
									GR	3	24	1/4		A	N	
23	24 3/16	3 3/4	MASSEY-FERGUSON		T	C	5	9	GR	5	24 1/4	1/8		A	N	279821
									GR	4 1/8	24 1/4	1/8		A	N	
23	24 3/8	3	FIAT ALLIS	HD-6	X	C	4	9	GR	4 3/4	25 3/4	3/16		A	N	287094
									GR	4 3/4	25 3/4	3/16		A	N	
23	24 3/8	3 3/4	MASSEY-FERGUSON		X	C	5	9	GR	5	24 1/4	C		A	N	289875
									GR	4	24 1/4	C		A	N	
23	25	3 11/16	FIAT ALLIS	HD-6 BRASS FINS	Z	B	5	10	GR	4 3/4	25 3/4	3/16		A	N	285001
									GR	4 3/4	25 3/4	3/16		A	N	
23	25	3 11/16	LIFT TRUCKS & LOADERS	CLARK	Z	C	5	9	GR	4 1/4	25 3/4	C		A	N	289122
									GR	4 1/4	25 3/4	C		A	N	
23	25	3 3/4	FIAT ALLIS	HD-6 BRASS FINS FACE DIPPED	B	B	5	6	GR	4 3/4	25 3/4	1/4		A	N	229551
									GR	4 3/4	25 3/4	1/4		A	N	
23	25	4 7/16	LIFT TRUCKS & LOADERS	SKIDDER BRASS FINS	Z	B	6	6		4 3/4	26	C		0	N	289906
										4 3/4	26	C		0	N	
23	26 1/4	1 3/4	FORD TRUCK	BKT T/HDR RD INL 8 1/2" RT	R	C	3	11	BU	5	27 3/8	1 9/16		A	N	226139
									GR	3	26 13/16	C		A	N	
23	27 1/2	4 7/16	JOHN DEERE	SKIDDER BRASS FINS	Z	B	6	9	GR	4 3/4	28 3/8	C		A	N	286756
									GR	4 3/4	28 3/8	C		A	N	
23	28 3/4	3 11/16	FIAT ALLIS	605	Z	C	5	7	BL	7 3/8	31 1/8	1 3/8	40	A	C	289322
									BL	7 3/8	31 1/8	1 3/8	40	A	C	
23	29	3 3/4	FIAT ALLIS	645 LOADER	B	C	5	7	GR	4	29 5/8	C		A	N	278621
									GR	4	29 5/8	C		A	N	
23	29 1/4	3 3/4	FIAT ALLIS	645 FRONT END LOADER	T	C	5	7	BL	7 3/8	31 1/4	1 1/2	40	A	C	265862
									BL	7 3/8	31 1/4	1 1/2	40	A	C	
23	29 3/8	3 11/16	FIAT ALLIS	645 LOADER	Z	C	5	8	GR	4	29 5/8	C		A	N	289435
									GR	4	29 5/8	C		A	N	
23 1/8	20	2 15/16	OLIVER HART PARR		Z	C	4	11	GR	6	22	3/8		A	N	286363
									GR	3 1/2	22	3/8		A	N	
23 1/8	20 5/8	2 3/16	OLIVER HART PARR	1800	Z	C	3	9	GR	6	22	1/4		A	N	286362
									GR	3 1/2	22	1/4		A	N	
23 1/8	22 9/16	1 1/4	INGERSOLL-RAND		VT	C	2	12	GR	3 1/2	23 3/4	C		A	N	122664
									GR	3 1/2	23 3/4	C		A	N	
23 1/8	22 9/16	2	INGERSOLL-RAND		VT	C	3	12	GR	3 1/2	23 3/4	C		A	N	122663
									GR	3 1/2	23 3/4	C		A	N	
23 1/8	23 1/8	1 3/4	INGERSOLL-RAND	100-175 COMPRESSOR 35312156	S	C	3	9	GR	3 7/16	23 3/4	C		A	N	229081
									GR	3 7/16	23 3/4	C		A	N	
23 1/8	23 1/8	2 3/8	GARDNER DENVER	150 CFM COMPRESSOR 200SPH300	S	C	4	11	GR	3	23 15/16	C		A	N	229070
									GR	3	23 15/16	C		A	N	
23 1/4	15 15/16	1 1/4	AMC		VT	C	2	12	GR	2 5/8	17 1/2	C		A	N	128449
									GR	2 5/8	17 1/2	C		A	N	
23 1/4	16 1/2	1 1/4	VOLVO		VT	C	2	12	GR	2 7/16	17 5/16	C		A	N	128155
									GR	2 7/16	17 5/16	C		A	N	
23 1/4	16 1/2	2	VOLVO		VT	C	3	14	GR	2 7/16	17 5/16	C		A	N	128171
									GR	2 7/16	17 5/16	C		A	N	
23 1/4	17 5/8	2	FORD		VT	C	3	12	GR	2 1/2	17 7/16	C		A	N	128607
									GR	2 1/2	17 7/16	C		A	N	
23 1/4	18 3/4	3 11/16	INT'L HARVESTER	220A COTTON PICKER	Z	C	5	8	GR	4 1/2	19 1/2	C		A	N	287721
									GR	4 1/2	19 1/2	C		A	N	
23 1/4	19 3/8	3 7/16	INT'L HARVESTER	806 DIESEL 391931-R1, 386860-R1	S	C	6	9	GR	4 1/2	19 1/2	C		A	N	229100
									GR	4 1/2	19 1/2	C		A	N	
23 1/4	19 3/8	3 3/4	INT'L HARVESTER	1256 TRACTOR	X	C	5	8	GR	4 1/4	19 7/8	C		A	N	221800
									GR	4 1/4	19 7/8	C		A	N	

Vista-Pro Automotive - Core Catalog
(Cores Sorted by Size)

Height	Width	Depth	Application	Description	Fin Type	Fin Matl	Rows	FPI	BH / TH Type	BH / TH Width	BH / TH Length	BH / TH OHF	BH / TH Bolts	BH / TH Shape	Hdr Support	Model #
23 1/4	21 1/4	1 3/4	FIAT ALLIS	320 BACKHOE 76022357	S	C	3	8	GR	3 7/16	21 7/8	1/8	A	N		229191
									GR	3 7/16	21 7/8	1/8				
23 1/4	21 1/4	2 15/16	JOHN DEERE		Z	C	4	10	GR	3 1/2	21 7/8	C	A	N		282777
									GR	3 1/2	21 7/8	C				
23 1/4	21 3/8	2 1/4	OLIVER HART PARR		T	C	3	11	GR	6	22	1/4	A	N		279433
									GR	3 1/2	22	1/4				
23 1/4	21 3/8	3	OLIVER HART PARR	1800 DIESEL	T	C	4	9	GR	6	22	1/4	A	N		223280
									GR	3 1/2	22	1/4				
23 1/4	22 1/2	3	FORD POWER PRODUCTS		X	C	4	11	GR	3 1/2	22 1/2	C	A	N		289159
									GR	3 1/2	22 1/2	C				
23 1/4	26 3/8	2	FORD		VT	C	3	12	BU	5	27 3/8	C	A	N		122524
									GR	3	26 13/16	C				
23 1/4	26 7/16	2 1/4	FORD TRUCK	F500-600 BKT T/HDR 1 1/2" INL 8 1/2" RT	T	C	3	10	BU	5	27 3/8	C	A	N		223160
									GR	3	26 13/16	C				
23 1/4	27 1/2	1 1/4	FORD TRUCK		VT	C	2	16	GR	2 7/8	27 7/8	7/8	A	N		128128
									GR	2 7/8	27 7/8	7/8				
23 1/4	27 1/2	1 1/4	FORD		VT	C	2	12	GR	4 1/8	27 7/8	1 3/4	A	N		128217
									GR	2 3/4	27 7/8	5/16				
23 1/4	27 1/2	2	FORD		VT	C	3	14	GR	2 7/8	27 7/8	C	A	N		128127
									GR	2 7/8	27 7/8	C				
23 1/4	27 1/2	2 3/16	FORD TRUCK	FEED LOT	Z	C	3	7	GR	2 7/8	27 7/8	C	A	N		286925
									GR	2 7/8	27 7/8	C				
23 1/4	28 1/16	2 5/8	FORD TRUCK		VT	C	4	14	GR	2 7/8	27 7/8	3/16	A	N		122660
									GR	2 7/8	27 7/8	3/16				
23 5/16	17 5/8	2	FORD		VT	C	3	12	GR	2 5/8	17 1/2	C	A	N		122366
									GR	2 5/8	17 1/2	C				
23 3/8	20	2 15/16	INT'L HARVESTER	103,15-30,16-35	Z	C	4	7	BL	6 1/8	24	1 1/4	28	F	C	280908
									BL	6 1/8	24	1 1/4	28	F		
23 7/16	24 3/16	3	CATERPILLAR	12 GRADER HVY BTM HDR	T	C	4	7	BL	5 3/4	26 9/16	C	24	H	C	271472
									BH	5 3/4	26 9/16	C	24	H		
23 7/16	24 3/16	3	CATERPILLAR	D-4 HVY BTM HDR	T	C	4	7	BL	5 3/4	26 5/8	C	24	T	C	274602
									BH	5 3/4	26 5/8	C	24	T		
23 7/16	24 3/8	2 15/16	CATERPILLAR	D-4 9H4771 HVY T/BTM HDRS	Z	C	4	7	BH	5 3/4	26 5/8	C	24	N	C	225039
									BH	5 3/4	26 5/8	C	24	N		
23 7/16	24 3/8	2 15/16	CATERPILLAR	D-4 2A1164 HVY T/BTM HDRS	Z	C	4	6	BH	5 3/4	26 5/8	1 1/8	24	GG	C	225230
									BH	5 3/4	26 5/8	1 1/8	24	GG		
23 1/2	12 13/16	1 9/16	SAAB		VE	C	3	16	GR	1 3/4	13 5/16	C	A	N		122689
									GR	1 3/4	13 5/16	C				
23 1/2	18 3/4	2 3/16	CATERPILLAR	D-4 4F7979 OFFSET FOR O/C	Z	C	3	9	BL	5 3/4	26 5/8	2 3/16	24	N	C	225038
									BL	5 3/4	26 5/8	2 3/16	24	N		
23 1/2	18 3/4	2 15/16	CATERPILLAR	D-4 4A2577 HVY BTM HDR OFFSET FOR O/C	Z	C	4	6	BL	5 3/4	26 5/8	1 1/16	24	N	C	225042
									BH	5 3/4	26 5/8	1 1/16	24	N		
23 1/2	20 5/8	2 15/16	INT'L HARVESTER	15-30	Z	C	4	7	BL	5 1/2	24	1 1/4	32	F	C	280494
									BL	5 1/2	24	1 1/4	32	F		
23 1/2	20 5/8	2 15/16	LIFT TRUCKS & LOADERS	PAYLOADER	Z	C	4	9	SQ	4	21 3/4	3/16	A	N		288040
									SQ	4	21 3/4	3/16				
23 1/2	20 13/16	3	CHRYSLER INDUSTRIAL		T	C	4	9	GR	5 1/2	21	C	A	N		270155
									GR	3	21	C				
23 5/8	14 7/8	1 1/4	INTERNATIONAL		VT	C	2	14	GR	2 3/8	16 1/2	C	A	N		124989
									GR	2 3/8	16 1/2	C				
23 5/8	14 7/8	2	GM		VT	C	3	14	GR	2 3/8	16 1/2	C	A	N		128196
									GR	2 3/8	16 1/2	C				
23 5/8	15 1/4	1	CHEVROLET		VE	C	2	14	GR	2 3/8	16 1/2	3/8	A	N		128106
									GR	2 3/8	16 1/2	3/8				
23 5/8	15 1/4	1 9/16	GM	VE CORE;3R-14 FPI	VE	C	3	14	GR	2 3/8	16 1/2	C	A	N		128107
									GR	2 3/8	16 1/2	C				
23 5/8	19 13/16	2 5/8	AUSTIN		VT	C	4	12	GR	3 1/4	20 5/8	C	A	N		128445
									GR	3 1/4	20 5/8	C				
23 5/8	31 3/8	2	FORD		VT	C	3	16	GR	3 5/8	31 1/4	3/8	A	N		128564
									GR	3 5/8	31 1/4	3/8				
23 5/8	31 3/8	2	FORD		VT	C	3	16	GR	3 5/8	31 1/4	1/4	A	N		128261
									GR	3 5/8	31 1/4	1/4				
23 5/8	31 3/8	2 5/8	FORD		VT	C	4	14	GR	3 5/8	31 1/4	3/8	A	N		128764
									GR	3 5/8	31 1/4	3/8				

Vista-Pro Automotive - Core Catalog
(Cores Sorted by Size)

Height	Width	Depth	Application	Description	Fin Type	Fin Matl	Rows	FPI	BH / TH Type	BH / TH Width	BH / TH Length	BH / TH OHF	BH / TH Bolts	BH / TH Shape	Hdr Support	Model #
23 5/8	31 3/8	2 5/8	FORD TRUCK	LIGHT TRUCK DIMPLED TUBE	VT	C	4	16	GR GR	3 5/8 3 5/8	31 1/4 31 1/4	C C		A A	N	128925
23 3/4	20 1/4	3 3/4	OLIVER HART PARR	HI-LIFT	T	C	5	8	BL BL	6 1/4 6 1/4	24 24	C C	26 26	J J	C	278465
23 3/4	21	4 1/2	INT'L HARVESTER	C-100 FRONT END LOADER BRASS FINS FACE DIPPED	B	B	6	7		5 7/8 5 7/8	21 7/8 21 7/8	1/8 5/8		0 0	N	279315
23 3/4	21 1/4	3	DRESSER INDUSTRIES	TD-6	X	C	4	7	BL BL	5 1/2 5 1/2	24 3/8 24 3/8	C C	23 23	A A	C	270925
23 3/4	22 1/2	3	CASE/INTERNATIONAL	1070	X	C	4	9	GR GR	3 3/4 3 3/4	22 7/8 22 7/8	C C		A A	N	278784
23 3/4	22 1/2	3	CASE/INTERNATIONAL	1070	X	C	4	9	GR GR	3 3/4 3 3/4	23 1/4 23 1/4	C C		A A	N	289700
23 3/4	22 1/2	3	DRESSER INDUSTRIES	TD-9	X	C	4	7	BL BL	5 1/2 5 1/2	25 3/4 25 3/4	C C	23 23	F F	C	274400
23 3/4	22 1/2	3 7/16	CASE/INTERNATIONAL	1070	S	C	6	9	GR GR	3 3/4 3 3/4	22 7/8 22 7/8	C C		A A	N	229028
23 3/4	22 1/2	3 11/16	CASE/INTERNATIONAL	1370	Z	C	5	11		3 3/4 3 3/4	22 7/8 22 7/8	C C		0 0	N	225332
23 3/4	22 1/2	3 3/4	CASE/INTERNATIONAL	1270,1370, 2290 TRACTOR	T	C	5	9	FR FR	3 3/4 3 3/4	22 7/8 22 7/8	C C		0 0	N	223017
23 3/4	23 1/16	3	FIAT ALLIS	220	T	C	4	8	GR GR	4 4	23 5/8 23 5/8	C C		A A	N	278625
23 3/4	23 1/8	3	SPEED SPRAYER		X	C	4	9	SQ SQ	4 4	23 1/4 23 1/4	1/4 1/4		A A	N	286785
23 3/4	25 7/8	2	DODGE		VT	C	3	15	GR GR	3 2 3/4	25 9/16 25 9/16	C C		A A	N	124923
23 13/16	22 1/2	2 7/8	CASE/INTERNATIONAL	1270 A-64483	S	C	5	8	GR GR	3 5/8 3 5/8	23 23	1/8 1/8		A A	N	229158
23 13/16	22 1/2	3 7/16	CASE/INTERNATIONAL	2290 A-165922, A-66330	S	C	6	9	GR GR	3 5/8 3 5/8	23 23	C C		A A	N	229159
23 7/8	20 5/8	3	JOHN DEERE	MOTOR GRADER	X	C	4	6	GR GR	3 3/8 3 3/8	21 7/8 21 7/8	C C		A A	N	289446
23 7/8	20 13/16	3	JOHN DEERE	MOTOR GRADER	T	C	4	6	GR GR	3 3/8 3 3/8	21 7/8 21 7/8	1/8 1/8		A A	N	278945
23 7/8	24 3/4	2 1/4	CATERPILLAR		T	C	3	8	GR GR	4 1/4 4 1/4	25 3/4 25 3/4	C C		A A	N	265637
23 15/16	20 5/8	4 7/16	DRESSER INDUSTRIES	TD-7 1248995-H91 744043-C1	S	C	8	9	GR GR	5 7/8 5 7/8	21 15/16 21 15/16	5/8 5/8		A A	N	229043
23 15/16	21 1/4	2 1/4	OLIVER HART PARR		X	C	3	6	BL BL	6 6	24 1/2 24 1/2	1 7/16 1 7/16	27 27	F F	C	260212
24	15 15/16	1 1/4	RAMBLER		VT	C	2	16	GR GR	2 3/4 2 3/4	17 1/2 17 1/2	C C		A A	N	124782
24	15 15/16	2	PACER		VT	C	3	12	GR GR	2 3/4 2 3/4	17 1/2 17 1/2	C C		A A	N	124783
24	17 1/2	5 3/16	MOTOR COACH IND (MC)	BUS BRASS FINS	Z	B	7	11	BL BL	7 3/4 7 3/4	19 1/4 19 1/4	C C	26 26	A A	C	282573
24	17 5/8	2	FORD		VT	C	3	12	GR GR	2 1/2 2 1/2	17 1/2 17 1/2	C C		A A	N	122278
24	17 5/8	2	FORD		VT	C	3	12	GR GR	2 5/8 2 5/8	17 1/2 17 1/2	C C		A A	N	122404
24	19 3/8	2 15/16	FORD TRACTOR	8000	Z	C	4	9	GR GR	3 3/8 3 3/8	20 20	C C		A A	C	286764
24	19 3/8	3 3/4	FORD TRACTOR	862	X	C	5	8	GR GR	4 4	20 20	C C		A A	C	282489
24	19 11/16	3	FORD TRACTOR	8000	T	C	4	9	GR GR	3 3/8 3 3/8	19 7/8 19 7/8	C C		A A	C	272639
24	19 11/16	3 3/4	FORD TRACTOR	862	T	C	5	8	GR GR	4 4	20 20	C C		A A	C	272640
24	20	1 7/8	LeROI	COMPRESSOR	X	C	2	9	GR GR	3 1/4 3 1/4	21 3/8 21 3/8	3/16 3/16		A A	C	289175
24	20 5/8	4 7/16	INT'L HARVESTER	C-100 FRONT END LOADER BRASS FINS	Z	B	6	9	GR GR	5 7/8 5 7/8	21 7/8 21 7/8	3/16 3/16		A A	C	285097
24	20 13/16	4 1/2	INT'L HARVESTER	C-100 FRONT END LOADER	T	C	6	9	GR GR	5 7/8 5 7/8	21 7/8 21 7/8	1/4 5/8		A A	C	265755

Vista-Pro Automotive - Core Catalog
(Cores Sorted by Size)

Height	Width	Depth	Application	Description	Fin Type	Fin Matl	Rows	FPI	BH / TH Type	BH / TH Width	BH / TH Length	BH / TH OHF	BH / TH Bolts	BH / TH Shape	Hdr Support	Model #
24	21	4 1/2	INT'L HARVESTER	BRASS FINS FACE DIPPED	B	B	6	7	GR GR	5 7/8 5 7/8	21 7/8 21 7/8	1/8 1/8		A A	C	272691
24	21 7/8	2 3/8	NAVISTAR	1810A	S	C	4	11	GR GR	3 1/2 3 1/2	22 1/2 22 1/2	C C		A A	C	266421
24	22 1/2	2 3/8	INT'L HARVESTER	966, 104594-C2, 121723-C1	S	C	4	8	GR GR	4 1/4 4 1/4	22 7/8 22 7/8	C C		A A	C	229101
24	22 1/2	2 7/8	INT'L HARVESTER	1066, 121724-C2, 71610-C1	S	C	5	9	GR GR	4 1/4 4 1/4	22 7/8 22 7/8	C C		A A	C	229102
24	22 1/2	3	DRESSER INDUSTRIES	WD-9	X	C	4	7	BL BL	5 7/8 5 7/8	24 3/8 24 3/8	1 1/4 1 1/4	30 30	A A	C	221828
24	22 1/2	3	INT'L HARVESTER	966, 1066	X	C	4	8	GR GR	4 1/4 4 1/4	22 7/8 22 7/8	C C		A A	C	221811
24	22 1/2	3	INT'L HARVESTER	966, 1066	T	C	4	7	GR GR	4 1/4 4 1/4	22 7/8 22 7/8	C C		A A	C	223181
24	22 1/2	3 7/16	INT'L HARVESTER	966, 1066	S	C	6	9	GR GR	4 1/4 4 1/4	22 7/8 22 7/8	C C		A A	C	229014
24	22 1/2	3 11/16	INT'L HARVESTER	1066	Z	C	5	10	GR GR	4 1/4 4 1/4	22 7/8 22 7/8	C C		A A	C	225460
24	22 1/2	3 3/4	DRESSER INDUSTRIES	WD-9	T	C	5	6	BL BL	5 7/8 5 7/8	24 3/8 24 3/8	C C	30 30	A A	C	261746
24	22 1/2	3 3/4	INT'L HARVESTER	966, 1066	X	C	5	7	GR GR	4 1/4 4 1/4	22 7/8 22 7/8	C C		A A	C	221505
24	22 1/2	3 3/4	INT'L HARVESTER	533587 R2	X	C	5	9	GR GR	4 1/4 4 1/4	22 7/8 22 7/8	C C		A A	C	221812
24	22 1/2	3 3/4	INT'L HARVESTER		T	C	5	8	GR GR	4 1/4 4 1/4	22 7/8 22 7/8	C C		A A	C	223184
24	22 1/2	3 15/16	INT'L HARVESTER	1486, 1586 71611-C1	S	C	7	9	GR GR	4 1/4 4 1/4	22 7/8 22 7/8	C C		A A	C	229015
24	23 5/8	3 3/4	LIFT TRUCKS & LOADERS	TROJAN	T	C	5	8	GR GR	4 4	24 24	C C		A A	C	279675
24	23 5/8	2 5/8	FORD		VT	C	4	12	GR GR	3 3	24 1/8 24 1/8	C C		A A	N	128462
24	24 3/16	2 1/4	NAVISTAR	A180 SCHOOL BUS	T	C	3	9	GR GR	2 1/2 2 1/2	24 24	C C		A A	C	223275
24	24 3/16	3	NAVISTAR		T	C	4	11		3 1/8 3 1/8	24 24	C C		0 0	C	263030
24	24 3/4	3	LIFT TRUCKS & LOADERS	HOUGH PAYLOADER	T	C	4	8	GR GR	4 3/4 4 3/4	25 1/2 25 1/2	1/8 1/8		A A	C	279672
24	24 3/4	3	SCHRAMM		T	C	4	9	BL BL	5 1/2 5 1/2	27 27	C C	36 36	A A	C	265533
24	25	2 7/8	FORD TRACTOR	1495 9619855	S	C	5	7	GR GR	3 1/4 3 1/4	25 1/2 25 1/2	C C		A A	C	229052
24	25	3	FORD TRACTOR		B	C	4	7	GR GR	3 1/4 3 1/4	25 1/2 25 1/2	C C		A A	C	229571
24	25	3	FORD TRACTOR	SWATHER	X	C	4	6	GR GR	3 1/4 3 1/4	25 1/2 25 1/2	C C		A A	C	265846
24	25	4 1/2	CASE/INTERNATIONAL	D1000 HVY BTM HDR BRASS FINS FACE DIPPED	B	B	6	7	GR BH	5 1/8 7 1/8	25 1/4 27 3/4	C C	40	A A	C	275088
24	25 5/16	4 1/2	CASE/INTERNATIONAL		T	C	6	9	GR BL	5 1/8 7 1/8	25 1/4 27 3/4	C C	40	A A	C	263354
24	25 1/2	3	MASSEY-FERGUSON	410 COMBINE	B	C	4	7	GR GR	3 1/4 3 1/4	25 3/4 25 3/4	C C		A A	C	275365
24	25 5/8	2 3/8	FORD TRUCK	C800-1000 C7TA-8005-DS	R	C	4	9	GR GR	4 1/4 4 1/4	26 1/4 26 1/4	C C		A A	C	226804
24	25 5/8	2 7/8	FORD TRUCK	C800-1000 C7TA-8005-DS	R	C	5	10	GR GR	4 1/4 4 1/4	26 1/4 26 1/4	C C		A A	C	226805
24	25 5/8	2 7/8	HESTON	WIND ROVER	S	C	5	6	GR GR	3 3/8 3 3/8	25 3/4 25 3/4	C C		A A	C	265994
24	25 7/8	3	FORD TRUCK	C800-1000 C7TA-8005-DS	T	C	4	11	GR GR	4 1/4 4 1/4	26 1/4 26 1/4	C C		A A	C	223137
24	25 7/8	3	FORD TRUCK	F800-1000 T750-800 BKT T/HDR 1 1/4" X 3" INL CTRD	T	C	4	11	BU GR	6 7/8 4 1/4	26 7/8 26 5/16	C C		A A	C	223139
24	26 1/4	2 3/8	FORD TRUCK	F800-1000 BKT T/HDR OVAL INL	R	C	4	8	BU GR	6 7/8 4 1/4	26 3/4 26 1/4	1 7/8 C		A A	C	226465

Vista-Pro Automotive - Core Catalog
(Cores Sorted by Size)

Height	Width	Depth	Application	Description	Fin Type	Fin Matl	Rows	FPI	BH / TH Type	BH / TH Width	BH / TH Length	BH / TH OHF	BH / TH Bolts	BH / TH Shape	Hdr Support	Model #
24 1/4	26 3/8	2	FORD		VT	C	3	12	GR GR	3 3	26 13/16 26 13/16	C C		A A	N	128473
24 1/4	26 3/8	2 5/8	FORD	PICKUP	VT	C	4	12	GR GR	4 1/4 3	26 1/4 26 13/16	C C		A A	N	124767
24 1/4	26 3/8	2 5/8	INTERNATIONAL		VT	C	4	13	GR GR	4 4	26 3/4 26 3/4	3/16 3/16		A A	N	122674
24 1/4	26 3/8	2 5/8	FORD		VT	C	4	12	GR GR	3 3	26 13/16 26 13/16	C C		A A	N	128653
24 1/4	26 7/16	2 1/4	FORD TRUCK		T	C	3	10	GR GR	3 3	26 13/16 26 13/16	C C		A A	C	223188
24 1/4	26 7/16	3	FORD TRUCK	C600-800	T	C	4	9		3 3	26 13/16 26 13/16	C C		0 0	C	223189
24 5/16	26 1/4	1 3/4	FORD TRUCK	F500-750 BKT T/HDR RD INL 8 1/2" RT	R	C	3	9	BU GR	5 3	27 7/16 26 13/16	C C		A A	C	226477
24 5/16	26 1/4	1 3/4	FORD TRUCK	L600-700 W/3208 CAT ENGINE LEVEL BKT T/HDR RD INL 8 1/2" LT	R	C	3	11	BU GR	5 3	27 7/16 26 13/16	1 5/16 3/8		A A	C	226478
24 5/16	26 1/4	2 3/8	FORD TRUCK	F700-900 W/AT BKT T/HDR RD INL 8 1/2" RT	R	C	4	9	BU GR	5 4 1/4	27 3/8 26 1/4	1 5/16 1 5/16		A A	C	226481
24 5/16	26 1/4	2 3/8	FORD TRUCK	F600-900 BKT T/HDR RD INL 8 1/2" RT	R	C	4	10	BU GR	5 3	27 3/8 26 13/16	C C		A A	C	226482
24 5/16	26 1/4	2 3/8	FORD TRUCK	LN7000 W/3208 CAT ENGINE LEVEL BKT T/HDR RD INL 8 1/2" LT	R	C	4	10	BU GR	5 3	27 3/8 26 13/16	C C		A A	C	226484
24 5/16	26 1/4	2 7/8	FORD TRUCK	B600-700 BKT T/HDR RD INL 8 1/2" RT	R	C	5	9	BU GR	5 3	27 3/8 26 13/16	1 C		A A	C	226148
24 5/16	26 1/4	2 7/8	FORD TRUCK	LN6000-7000 W/3208 CAT ENGINE LEVEL BKT T/HDR RD INL 8 1/2" LT	R	C	5	11	BU GR	5 3	27 3/8 26 13/16	C C		A A	C	226486
24 5/16	26 1/4	2 7/8	FORD TRUCK	F600-800 BKT T/HDR 5" X 4" CRANK ROX	R	C	5	11	BU GR	5 3	27 3/8 26 13/16	C C		A A	C	226820
24 5/16	26 1/4	2 15/16	FORD TRUCK	FEED LOT BKT T/HDR RD INL 8 1/2" RT	Z	C	4	7	BU FR	5 3	27 5/16 26 13/16	C C		A A	C	286466
24 5/16	26 3/8	2	FORD		VT	C	3	12	BU GR	5 3	27 3/8 26 13/16	C C		A A	N	128743
24 5/16	26 3/8	2	FORD TRUCK		VT	C	3	12	BU GR	5 3	27 3/8 26 13/16	C C		A A	N	122457
24 5/16	26 3/8	2	FORD		VT	C	3	12	BU GR	5 4 1/4	27 3/8 26 1/4	C C		A A	N	128659
24 5/16	26 3/8	2 5/8	FORD		VT	C	4	12	BU GR	5 3	27 3/8 26 13/16	C C		A A	N	128274
24 5/16	26 3/8	2 5/8	FORD		VT	C	4	12	BU GR	5 4 1/4	27 3/8 26 1/4	C 3/16		A A	N	128654
24 5/16	26 7/16	2 1/4	FORD TRUCK	F600-700 BKT T/HDR RD INL 8 1/2" RT	T	C	3	10	BU GR	5 3	27 5/16 26 13/16	C C		A A	C	223167
24 5/16	26 7/16	3	FORD TRUCK	F600-750 BKT T/HDR RD INL 8 1/2" RT	T	C	4	9	BU GR	5 3	27 5/16 26 13/16	C C		A A	C	223174
24 5/16	26 7/16	3	FORD TRUCK	LN6000-7000 LEVEL BKT T/HDR RD INL 8 1/2" LT	T	C	4	10	BU GR	5 3	27 3/8 26 13/16	C C		A A	C	223201
24 5/16	26 7/16	3	FORD TRUCK	F700-900, W/AT BKT T/HDR RD INL 8 1/2" RT	T	C	4	10	BU GR	5 4 1/4	27 3/8 26 1/4	C 1/4		A A	C	223284
24 5/16	26 1/2	3	FORD TRUCK	BKT T/HDR RD INL 8 1/2" RT	B	C	4	6	BU GR	5 3	27 3/8 26 13/16	C C		A A	C	229572
24 3/8	19 3/8	2 1/4	JOHN DEERE	4010	X	C	3	8	GR GR	5 3/8 3 1/4	19 7/8 19 7/8	2 1/4 1/4		A A	C	221506
24 3/8	19 3/8	2 7/8	JOHN DEERE	4010, 4020	S	C	5	7	GR GR	5 3/8 3 1/4	19 7/8 19 7/8	1/8 1/8		A A	C	229019
24 3/8	19 3/8	2 15/16	JOHN DEERE	4010, 4020	Z	C	4	7	GR GR	5 3/8 3 1/4	19 7/8 19 7/8	3/4 1/4		A A	C	273617
24 3/8	19 3/8	3	JOHN DEERE	4010, 4020 AR 46449	X	C	4	8	GR GR	5 3/8 3 1/4	19 7/8 19 7/8	2 1/4 1/4		A A	C	221510
24 3/8	19 3/8	3	JOHN DEERE	4020 TRACTOR AR 49455	X	C	4	8	GR GR	5 3/8 3 1/4	19 7/8 19 7/8	3/16 3/16		A A	C	221820
24 3/8	19 1/2	3	JOHN DEERE	4020	B	C	4	8	GR GR	5 3/8 3 1/4	19 7/8 19 7/8	1/8 1/8		A A	C	229516
24 3/8	19 11/16	2 1/4	JOHN DEERE	4010	T	C	3	8	GR GR	5 3/8 3 1/4	19 7/8 19 7/8	2 1/4 1/4		A A	C	263240

Vista-Pro Automotive - Core Catalog
(Cores Sorted by Size)

Height	Width	Depth	Application	Description	Fin Type	Fin Matl	Rows	FPI	BH / TH Type	BH / TH Width	BH / TH Length	BH / TH OHF	BH / TH Bolts	BH / TH Shape	Hdr Support	Model #
24 3/8	20	2 1/4	JOHN DEERE	4020 TRACTOR	X	C	3	8	GR	5 3/8	19 7/8	1/8		A	C	221246
									GR	3 1/4	19 7/8	1/8				
24 3/8	22 1/2	2 1/4	GARDNER DENVER	SP 125G	T	C	3	8	BL	4 3/8	26 3/8	C	28	A	C	223146
									BL	4 3/8	26 3/8	C	28	A		
24 3/8	24 3/4	3 3/4	LIFT TRUCKS & LOADERS	LOADER	T	C	5	9	GR	4 3/4	25 1/2	C		A	C	279677
									GR	4 3/4	25 1/2	C				
24 3/8	26 1/4	2 3/8	FORD	PICK UP	R	C	4	9	GR	4 1/4	26 1/4	1/2		A	C	289747
									GR	3	26 13/16	1/2				
24 3/8	26 15/16	2 5/8	MILITARY	MILITARY CORE "M998"	VT	C	4	12	GR	3 1/2	28	C		A	N	220037
									GR	3 1/2	28	C				
24 3/8	27 1/2	2 7/8	AM GENERAL	HUMMER 6.2L DIESEL LOW FLOW DIMPLED TUBE	R	C	5	11	GR	3 5/16	27 5/8	C		A	C	226037
									GR	3 5/16	27 5/8	C				
24 3/8	27 9/16	3 3/4	CASE/INTERNATIONAL	1570	T	C	5	7	GR	4 3/16	28 1/4	C		A	C	272461
									GR	4 3/16	28 1/4	C				
24 7/16	28 1/8	3	GALION	101-104,116, 118 GRADER HVY BTM HDR	T	C	4	9	BL	5 1/2	32	C	28	F	C	279217
									BH	5 1/2	32	C	28	F		
24 1/2	17 5/8	1 1/4	FORD	GRANADA	VT	C	2	14	GR	2 13/16	18 7/8	1/4		A	N	122679
									GR	2 13/16	18 7/8	1/4				
24 1/2	18 1/8	1 1/4	FORD		VT	C	2	14	GR	2	18 7/8	5/16		A	N	124983
									GR	2 1/2	18 7/8	5/16				
24 1/2	18 1/8	1 1/4	FORD		VT	C	2	13	GR	2 13/16	18 7/8	5/16		A	N	124741
									GR	2 13/16	18 7/8	5/16				
24 1/2	18 1/8	2	LINCOLN		VT	C	3	12	GR	3 7/16	18 7/8	3/4		A	N	122579
									GR	2 7/8	18 7/8	3/4				
24 1/2	18 1/8	2	MERCURY		VT	C	3	14	GR	2 13/16	18 7/8	5/16		A	N	124742
									GR	2 13/16	18 7/8	5/16				
24 1/2	18 1/8	2 5/8	FORD		VT	C	4	12	GR	3 3/8	18 7/8	3/4		A	N	122609
									GR	2 13/16	18 7/8	C				
24 1/2	18 1/8	2 5/8	FORD		VT	C	4	12	GR	2 7/8	18 7/8	C		A	N	122627
									GR	2 7/8	18 7/8	C				
24 1/2	18 3/16	1 9/16	FORD		VE	C	3	16	GR	2	18 7/8	C		A	N	128721
									GR	2 1/2	18 7/8	3/8				
24 1/2	19 3/8	2 1/4	JOHN DEERE	4010	X	C	3	7	GR	5 3/8	19 7/8	7/8		A	C	221799
									GR	3 1/4	19 7/8	7/8				
24 1/2	19 3/8	2 15/16	JOHN DEERE	FEED LOT BRASS FINS	Z	B	4	7	GR	5 3/8	19 7/8	3/16		A	C	286463
									GR	3 1/4	19 7/8	3/16				
24 1/2	19 3/8	3	JOHN DEERE	4020	X	C	4	9	GR	5 3/8	19 7/8	3/16		A	C	221787
									GR	3 1/4	19 7/8	C				
24 1/2	19 11/16	2 1/4	JOHN DEERE	4010	T	C	3	8	GR	5 7/16	19 7/8	1		A	C	274953
									GR	3 1/4	19 7/8	3/4				
24 1/2	22	2 5/8	INTERNATIONAL		VT	C	4	12	GR	2 3/4	22 1/16	C		A	N	128530
									GR	2 3/4	22 1/16	C				
24 1/2	24 3/4	3 3/4	SPEED SPRAYER		T	C	5	8	GR	4 5/8	25 1/2	1/4		A	C	265368
									GR	4 5/8	25 1/2	1/4				
24 1/2	26 1/4	3 11/16	FIAT ALLIS	7050	Z	C	5	9	GR	4	26 1/2	C		A	C	286716
									GR	4	26 1/2	C				
24 1/2	27	3	JOHN DEERE	GD544	T	C	4	7	GR	4 1/4	28 1/4	C		A	C	223614
									GR	4 1/4	28 1/4	C				
24 1/2	27 1/2	3	JOHN DEERE	GD544	X	C	4	6	GR	4 1/4	28 1/4	C		A	C	289517
									GR	4 1/4	28 1/4	C				
24 1/2	28 3/4	2 15/16	DRESSER INDUSTRIES	TD-14 HVY BTM HDR	Z	C	4	10	BL	5 1/2	32	1 1/4	29	A	C	287188
									BH	5 1/2	32	1 1/4	28	A		
24 1/2	28 3/4	3	DRESSER INDUSTRIES	TD-14 HVY BTM HDR	X	C	4	7	BL	5 1/2	32	C	29	A	C	274402
									BH	5 1/2	32	C	29	A		
24 5/8	17 1/2	5 3/16	MOTOR COACH IND (MCI)	BUS BRASS FINS	Z	B	7	11	BL	7 7/8	19 5/8	C	34	A	C	282171
									BL	7 7/8	19 5/8	C	34	A		
24 5/8	17 1/2	6	MOTOR COACH IND (MCI)	BRASS FINS	Z	B	8	10	BL	9 5/8	19 5/8	C	36	A	C	225647
									BL	9 5/8	19 5/8	C	36	A		
24 5/8	22	1 1/4	INTERNATIONAL		VT	C	2	12	GR	2 3/4	22	1 1/4		A	N	124664
									GR	2 3/4	22	1 1/4				
24 5/8	22	2	INTERNATIONAL		VT	C	3	12	GR	2 11/16	22 1/4	3/16		A	N	122694
									GR	2 11/16	22 1/4	3/16				
24 5/8	22	2	INTERNATIONAL		VT	C	3	12	GR	2 3/4	22	C		A	N	124549
									GR	2 3/4	22	C				

Vista-Pro Automotive - Core Catalog
(Cores Sorted by Size)

Height	Width	Depth	Application	Description	Fin Type	Fin Matl	Rows	FPI	BH / TH Type	BH / TH Width	BH / TH Length	BH / TH OHF	BH / TH Bolts	BH / TH Shape	Hdr Support	Model #
24 5/8	23 5/8	2	GM		VT	C	3	12	BU GR	4 3/8 3 3/8	23 3/4 23 3/4	C C		A A	N	122236
24 5/8	23 5/8	2 5/8	GM		VT	C	4	12	BU BU	4 3/8 3 3/8	23 3/4 23 3/4	C C		A A	N	122414
24 5/8	26 1/4	2 3/8	FIAT ALLIS	8010 TRACTOR 264168	S	C	4	11	GR GR	4 1/4 4 1/4	26 5/8 26 5/8	1/8 1/8		A A	C	229180
24 5/8	26 1/4	2 7/8	FIAT ALLIS	8030 TRACTOR 275254	S	C	5	11	GR GR	4 1/4 4 1/4	26 5/8 26 5/8	1/4 1/4		A A	C	229178
24 5/8	26 1/4	3	FIAT ALLIS	7030	X	C	4	10	GR GR	4 4	26 1/2 26 1/2	C C		A A	C	286715
24 5/8	26 1/4	3 7/16	FIAT ALLIS	8030, 8050 264227	S	C	6	11	GR GR	4 1/4 4 1/4	26 5/8 26 5/8	1/8 1/8		A A	C	229179
24 5/8	28 11/16	3	ADAMS GRADER	HVY BTM HDR	T	C	4	10	BL BH	6 1/4 6 1/4	33 3/8 33 3/8	1 1/2 1 1/2	36 36	A A	C	223025
24 11/16	26 1/4	4 7/16	CAT-LeMASTER	508 SKIDDER 4W8922 GROUP REPL 6 CORES BRASS FINIS	Z	B	6	7	BH BH	6 1/2 6 1/2	25 1/2 25 1/2	C C	32 32	0 0	C	284240
24 3/4	11 1/4	3 11/16	LIFT TRUCKS & LOADERS	METRO BOB CAT	Z	C	5	6	GR GR	4 1/4 4 1/4	12 12	C C		A A	C	282667
24 3/4	21 7/8	2 3/8	DETROIT DIESEL	INGRAM ROLLER	S	C	4	10	BL BL	5 1/2 5 1/2	25 3/4 25 3/4	C C	38 38	A A	C	272883
24 3/4	21 7/8	3 7/16	FORD TRACTOR	9700 3/8" RADIUS HDR	S	C	6	8	GR GR	4 4	22 22	C C		A A	C	229204
24 3/4	21 7/8	3 3/4	FORD TRACTOR	8200	X	C	5	8	GR GR	4 1/2 4 1/2	22 22	C C		A A	C	282767
24 3/4	21 15/16	3 3/4	FORD TRACTOR	A700	T	C	5	8	GR GR	4 4	22 22	C C		A A	C	223166
24 3/4	23 1/8	1 1/4	CHEV/GMC	CHEV TRK	VT	C	2	12	GR GR	2 3/4 2 3/4	25 7/16 25 7/16	3/8 3/8		A A	N	122513
24 3/4	23 1/8	1 1/4	CHEVROLET		VT	C	2	12	GR GR	3 2 3/4	25 7/16 25 7/16	3/8 3/8		A A	N	122451
24 3/4	23 1/8	2	CHEVROLET		VT	C	3	12	GR GR	2 3/4 2 3/4	25 7/16 25 7/16	C C		A A	N	122369
24 3/4	23 1/8	2	CHEVROLET		VT	C	3	12	GR GR	3 2 3/4	25 7/16 25 7/16	C C		A A	N	122476
24 3/4	23 1/8	2	GM		VT	C	3	12	GR GR	3 3	25 7/16 25 7/16	C C		A A	N	128468
24 3/4	23 1/8	2 5/8	GM		VT	C	4	12	GR GR	3 2 3/4	25 7/16 25 7/16	C C		A A	N	128485
24 3/4	23 5/8	2 5/8	INTERNATIONAL		VT	C	4	12	GR GR	3 1/8 3 1/8	24 24	C C		A A	N	122335
24 3/4	23 3/4	1 3/4	CHEV/GMC	C 50-60 CELLULAR REPLACEMENT	R	C	3	8	BX BX	2 2	23 5/8 23 5/8	C C		A A	C	226343
24 3/4	23 3/4	2 3/8	NAVISTAR	R190	R	C	4	8		3 1/8 3 1/8	24 24	3/16 3/16		0 0	C	226632
24 3/4	24 3/16	3	NAVISTAR		T	C	4	11	GR GR	3 1/8 3 1/8	24 24	C C		A A	C	223285
24 3/4	24 3/4	3	FRANKLIN LOGGER		T	C	4	6	GR GR	4 3/4 4 3/4	25 1/2 25 1/2	C C		A A	C	265505
24 3/4	31 7/8	3 7/16	F.W.D.		R	C	6	11	BL BL	6 5/8 6 5/8	34 34	C C	42 42	A A	C	226448
24 7/8	19 11/16	2 1/4	JOHN DEERE	4030	T	C	3	8	GR GR	5 1/2 3 3/8	20 20	1/8 1/8		A A	C	277364
24 7/8	21 7/8	1 3/4	NAVISTAR	1700-1800 C/FLO	R	C	3	7	GR GR	2 1/2 2 1/2	22 3/8 22 3/8	3/16 3/16		A A	C	226633
24 7/8	21 15/16	3	DETROIT DIESEL	INGRAM ROLLER	T	C	4	8	BL BL	5 1/2 5 1/2	25 3/4 25 3/4	C C	38 38	A A	C	272884
24 7/8	22	2	INTERNATIONAL		VT	C	3	12	GR GR	2 1/4 2 1/4	21 9/16 21 9/16	C C		A A	N	124661
24 7/8	24 3/4	2 1/4	BARBER-GREENE	3-53 DETROIT ENGINE	T	C	3	9	GR GR	4 3/4 4 3/4	25 1/2 25 1/2	C C		A A	C	223006
24 7/8	24 3/4	2 1/4	DETROIT DIESEL		T	C	3	10	GR GR	4 3/4 4 3/4	25 1/2 25 1/2	C C		A A	C	223089
24 7/8	24 3/4	2 1/4	DETROIT DIESEL		T	C	3	10	GR GR	4 3/4 4 3/4	25 1/2 25 1/2	1/4 1/4		A A	C	223090

Vista-Pro Automotive - Core Catalog
(Cores Sorted by Size)

Height	Width	Depth	Application	Description	Fin Type	Fin Matl	Rows	FPI	BH / TH Type	BH / TH Width	BH / TH Length	BH / TH OHF	BH / TH Bolts	BH / TH Shape	Hdr Support	Model #
24 7/8	24 3/4	3 3/4	LIFT TRUCKS & LOADERS	BAKER	T	C	5	9	GR	4 5/8	25 1/2	C		A	C	261840
									GR	4 5/8	25 1/2	C	A			
24 7/8	25	2 3/16	DETROIT DIESEL		Z	C	3	9	GR	4	25 7/8	1/2		A	C	281616
									GR	4	25 7/8	1/2	A			
24 7/8	26 1/4	3	FIAT ALLIS	TL-20	X	C	4	8	GR	4	26 3/4	1/4		A	C	266163
									GR	4	26 3/4	1/4	A			
24 7/8	26 1/4	3 11/16	FIAT ALLIS	TL-30	Z	C	5	8	GR	4	26 3/4	3/8		A	C	289083
									GR	4	26 3/4	3/8	A			
25	17 5/8	2	FORD		VT	C	3	12	GR	2 5/8	17 1/2	C		A	N	122430
									GR	2 5/8	17 1/2	C	A			
25	19 1/4	1 1/4	FORD		VT	C	2	12	GR	2 7/8	19	C		A	N	122541
									GR	2 7/8	19	C	A			
25	19 1/4	2	LINCOLN		VT	C	3	14	GR	2 7/8	19	C		A	N	122512
									GR	2 7/8	19	C	A			
25	19 1/4	2 5/8	FORD		VT	C	4	12	GR	2 7/8	19	C		A	N	122570
									GR	2 7/8	19	C	A			
25	19 3/8	3	MINNEAPOLIS MOLINE	G1000	X	C	4	8	GR	3 3/8	19 5/8	5/16		A	C	288698
									GR	3 3/8	19 5/8	5/16	A			
25	21 1/4	3	JOHN DEERE	4320	X	C	4	9	GR	6	21 7/8	C		A	C	221788
									GR	3 1/2	21 7/8	C	A			
25	21 1/4	3	JOHN DEERE	4320	X	C	4	11	GR	6	21 7/8	5/16		A	C	260776
									GR	3 1/2	21 7/8	5/16	A			
25	21 1/4	3	JOHN DEERE	4320	X	C	4	9	GR	6	21 7/8	C		A	C	289420
									GR	3 1/2	21 7/8	C	A			
25	21 3/8	3	JOHN DEERE	4320	T	C	4	9	GR	6	21 7/8	C		A	C	223206
									GR	3 1/2	21 7/8	C	A			
25	21 1/2	3	JOHN DEERE		B	C	4	7	GR	6	21 7/8	C		A	C	277365
									GR	3 1/2	21 7/8	C	A			
25	21 7/8	2 3/8	NAVISTAR	1800	R	C	4	11	GR	3 3/8	22 1/2	1/4		A	C	226634
									GR	3 3/8	22 1/2	1/4	A			
25	21 15/16	2 1/4	NAVISTAR	CO1800	T	C	3	11	GR	3 3/8	22 1/2	1/4		A	C	264370
									GR	3 3/8	22 1/2	1/4	A			
25	22	2	INTERNATIONAL		VT	C	3	12	GR	2 1/2	21 11/16	C		A	N	128656
									GR	2 1/2	21 11/16	C	A			
25	22 1/2	3 3/4	CASE/INTERNATIONAL	850-B LOADER BRASS FIN	T	B	5	6	BL	7 1/4	25	1 3/4	30	A	C	265611
									BL	7 1/4	25	1 3/4	30	A		
25	22 1/2	3 3/4	CASE/INTERNATIONAL		X	C	5	6	BL	7 1/4	25	1 3/4	30	A	C	281633
									BL	7 1/4	25	1 3/4	30	A		
25	22 1/2	4 1/2	CASE/INTERNATIONAL	850-B LOADER HVY BTM HDR BRASS FIN	B	B	6	7	BL	7 1/4	25	C	30	A	C	272462
									BH	7 1/4	25	C	30	A		
25	23 1/8	3 3/4	FIAT ALLIS	D-21	X	C	5	8	GR	4	23 3/4	C		A	C	289522
									GR	4	23 3/4	C	A			
25	23 5/8	3	PETTIBONE	402 GRADER	T	C	4	8	BL	6 1/8	26 7/8	1 1/4	32	A	C	263483
									BL	6 1/8	26 7/8	1 1/4	32	A		
25	24 3/4	3	CATERPILLAR	613 SCRAPER	T	C	4	9	GR	3 7/16	25 5/8	C		A	C	223018
									GR	3 7/16	25 5/8	C	A			
25	25	2 3/8	BLAW KNOX	ASPHALT SPREADER 164-659	S	C	4	9	GR	4 5/16	25 3/4	1/8		A	C	229135
									GR	4 5/16	25 3/4	1/8	A			
25	25	3 7/16	BLAW KNOX	PLANER 164-741	S	C	6	9	GR	4 5/16	25 3/4	C		A	C	229138
									GR	4 5/16	25 3/4	C	A			
25	27 1/2	3	VOLVO TRUCK		VH	C	4	16	BL	7	30 3/8	1 3/4	42	A	N	251139
									BL	7	30 3/8	1 3/4	42	A		
25	35	2 3/8	OSHKOSH TRUCK	X-4330 E-2468-1	R	C	4	11	BL	7	37 1/2	C	46	A	C	226822
									BL	7	37 1/2	C	46	A		
25	35	3	OSHKOSH TRUCK	X-4003-1 E2468 NEW VH CONSTRUCTION	VH	C	4	14	BL	7	37 1/2	C	46	A	N	251001
									BL	7	37 1/2	C	46	A		
25 1/8	19 1/8	2 1/4	MINNEAPOLIS MOLINE	670 SUPER	T	C	3	8	GR	3 3/8	19 7/8	1/4		A	C	279847
									GR	3 3/8	19 7/8	1/4	A			
25 1/8	19 3/8	2 1/4	MINNEAPOLIS MOLINE	670 SUPER	X	C	3	9	GR	3 3/8	19 7/8	1/4		A	C	288923
									GR	3 3/8	19 7/8	1/4	A			
25 1/8	19 3/8	3 3/4	INT'L HARVESTER	DIESEL 660 WHEATLAND	X	C	5	7	GR	4 1/4	19 3/4	C		A	C	288192
									GR	4 1/4	19 3/4	C	A			
25 1/8	25	2 1/4	DETROIT DIESEL	3-53 POWER UNIT	X	C	3	8	GR	4	25 3/4	1/4		0	C	221500
									GR	4	25 3/4	1/4	0			

Vista-Pro Automotive - Core Catalog
(Cores Sorted by Size)

Height	Width	Depth	Application	Description	Fin Type	Fin Matl	Rows	FPI	BH / TH Type	BH / TH Width	BH / TH Length	BH / TH OHF	BH / TH Bolts	BH / TH Shape	Hdr Support	Model #
25 1/8	25	2 1/4	DETROIT DIESEL	4-53 ENGINE	X	C	3	8	GR	4	25 3/4	1/4		A	C	221805
									GR	4	25 3/4	1/4				
25 1/8	25	3 11/16	AJAX		Z	C	5	10	GR	4 3/4	26 3/4	3/16		A	C	225261
									GR	4 3/4	26 3/4	3/16				
25 1/8	25 5/16	2 1/4	DETROIT DIESEL	3-53 ENGINE	T	C	3	8	GR	4	25 3/4	1/4		A	C	223117
									GR	4	25 3/4	1/4				
25 1/8	25 5/16	2 1/4	LIFT TRUCKS & LOADERS	WAGNER	T	C	3	8	GR	3 7/8	25 3/4	1/8		A	C	279681
									GR	3 7/8	25 3/4	1/8				
25 1/8	25 5/16	3	DETROIT DIESEL	3-53 ENGINE	T	C	4	8	GR	4	25 3/4	3/16		A	C	223126
									GR	4	25 3/4	3/16				
25 1/8	25 5/8	3 9/16	AJAX	9 1/2 X 12	X	C	5	8	GR	4 3/4	26 3/4	1/4		A	C	221200
									GR	4 3/4	26 3/4	1/4				
25 1/8	25 5/8	3 3/4	AJAX		X	C	5	8	SQ	4 1/4	26 1/2	FF		A	C	222100
									SQ	4 1/4	26 1/2	FF				
25 1/8	26 1/4	3	CATERPILLAR	3208	X	C	4	10	GR	4	26 7/8	C		A	C	286717
									GR	4	26 7/8	C				
25 1/4	21 7/8	2 7/8	MACK TRUCKS	MIDLINER MS-2000	R	C	5	11	GR	3 5/16	22 5/16	C		A	C	226565
									GR	3 5/16	22 5/16	C				
25 1/4	22 5/16	2 1/4	MACK TRUCKS		VE	C	4	14	GR	3 5/16	22 5/16	C		A	N	128765
									GR	3 5/16	22 5/16	C				
25 1/4	25	2 15/16	LIFT TRUCKS & LOADERS	HUSKY LIFT	Z	C	4	10	GR	4	25 7/8	3/16		A	C	286871
									GR	4	25 7/8	3/16				
25 1/4	25 5/16	3	LIFT TRUCKS & LOADERS	HUSKY LIFT	T	C	4	10	GR	4	25 7/8	3/16		A	C	266382
									GR	4	25 7/8	3/16				
25 1/4	25 5/8	3 11/16	DROTT	1800 CRANE	Z	C	5	11	GR	4	27	C		A	C	225516
									GR	4	27	C				
25 1/4	25 7/8	2	FORD TRUCK	CARGO STAR	VT	C	3	12	GR	3 1/2	25 3/4	C		A	N	122675
									GR	3 1/2	25 3/4	C				
25 1/4	26 1/4	2 1/4	LIFT TRUCKS & LOADERS	TOWMOTOR	X	C	3	9	GR	4	27	C		A	C	286397
									GR	4	27	C				
25 1/4	35 7/16	4 1/2	EUCLID	R-22 DUMP TRUCK 4018449, 4039339 HVY BTM HDR	T	C	6	7	BL	7 1/4	39 1/2	C	36	A	C	223591
									BH	7 1/4	39 1/2	C	36	A		
25 1/4	35 5/8	4 7/16	EUCLID	R-22 HVY BTM HDR BRASS FINS	Z	B	6	11	BL	7 1/4	39 1/2	C	36	A	C	289132
									BH	7 1/4	39 1/2	C	36	A		
25 3/8	18	3 3/4	CASE/INTERNATIONAL		T	C	5	9	GR	5	18 3/8	1/8		A	C	278786
									GR	4	18 3/8	1/8				
25 3/8	19 1/8	3	BOMBARDIER		T	C	4	8		3 1/4	19 7/8	C		0	C	223051
										3 1/4	19 7/8	C				
25 3/8	24 3/16	3	CATERPILLAR	112 GRADER 7S584 HVY T/BTM HDRS	T	C	4	8	BH	5 3/8	28 3/8	C	26	B	C	265030
									BH	5 3/8	25 3/8	C	28	A		
25 3/8	25 5/16	2 1/4	DODGE TRK	800 DIESEL	T	C	3	9	GR	5	25 3/4	C		A	C	223102
									GR	3	25 3/4	C				
25 3/8	25 5/8	1 3/4	DODGE TRK	CT700-1000	R	C	3	11	GR	5	25 3/4	C		A	C	226437
									GR	3	25 3/4	C				
25 3/8	25 5/8	3	CATERPILLAR	112 GRADER HVY BTM HDR	X	C	4	8	BL	5 3/8	28 3/8	C	26	DD	C	274939
									BH	5 3/8	28 3/8	C	26	DD		
25 3/8	35 7/16	3 3/4	EUCLID	FD-28	T	C	5	7	BL	6 1/4	39 1/2	C	34	H	C	223620
									BL	6 1/4	39 1/2	C	34	H		
25 3/8	35 5/8	3 11/16	EUCLID	FD-5	Z	C	5	8	BL	6 1/4	39 1/2	1 1/4	34	H	C	287564
									BL	6 1/4	39 1/2	1 1/4	34	H		
25 3/8	35 5/8	3 3/4	EUCLID	FD-5	X	C	5	8	BL	6 1/4	39 1/2	C	34	H	C	266060
									BL	6 1/4	39 1/2	C	34	H		
25 1/2	19 3/8	3	JOHN DEERE	4010, 4020	X	C	4	10	GR	5 3/8	19 7/8	3/8		A	C	221507
									GR	3 1/4	19 7/8	C				
25 1/2	19 3/8	3	JOHN DEERE	4230 AT 60371	X	C	4	10	GR	5 3/8	20	3/16		A	C	221798
									GR	3 1/4	20	3/16				
25 1/2	19 3/8	3	JOHN DEERE		X	C	4	10	GR	5 3/8	20	1/4		A	C	266240
									GR	3 3/4	20	1/4				
25 1/2	19 3/8	3 7/16	JOHN DEERE		S	C	6	10	GR	5 3/8	20	1/4		A	C	266541
									GR	3 3/4	20	1/4				
25 1/2	19 3/8	3 7/16	JOHN DEERE	4230	S	C	6	10	GR	5	20	1/4		A	C	266542
									GR	3 3/4	20	1/4				
25 1/2	19 3/8	3 3/4	JOHN DEERE	4230	X	C	5	10	GR	5	20	1/4		A	C	221499
									FR	3 3/4	20	C				

Vista-Pro Automotive - Core Catalog
(Cores Sorted by Size)

Height	Width	Depth	Application	Description	Fin Type	Fin Matl	Rows	FPI	BH / TH Type	BH / TH Width	BH / TH Length	BH / TH OHF	BH / TH Bolts	BH / TH Shape	Hdr Support	Model #
25 1/2	19 3/8	3 3/4	JOHN DEERE	4230	X	C	5	9	GR GR	5 3 3/4	20 20	3/16 C		A A	C	221797
25 1/2	19 3/8	3 3/4	JOHN DEERE	CAN USE 221499	X	C	5	10	GR GR	4 7/8 4	20 20	1/4 1/4		A A	C	266220
25 1/2	19 11/16	3	JOHN DEERE	4230	T	C	4	9	GR GR	5 3 3/4	20 20	3/16 3/16		A A	C	223207
25 1/2	19 11/16	3	JOHN DEERE	4230	T	C	4	10	GR GR	5 3/8 3 1/4	20 20	3/16 C		A A	C	223212
25 1/2	19 11/16	3 3/4	JOHN DEERE	4230	T	C	5	9	GR GR	5 3 3/4	20 20	3/16 C		A A	C	223227
25 1/2	22 1/2	2 7/8	VOLVO WHITEGMC		R	C	5	11	GR GR	3 1/4 3 1/4	22 3/4 22 3/4	C C		A A	C	226732
25 1/2	25	3 11/16	FIAT ALLIS	HD-7G BRASS FINS	Z	B	5	8	GR GR	4 3/4 4 3/4	25 3/4 25 3/4	3/16 3/16		A A	C	285027
25 1/2	26 7/16	2 1/4	CATERPILLAR	225 SHOVEL 3N2913	T	C	3	8	GR GR	4 4	26 7/8 26 7/8	C C		A A	C	223019
25 1/2	28 3/4	2 3/8	CHEV/GMC	T 6000	R	C	4	11	GR GR	3 1/2 3 1/2	28 7/8 28 7/8	C C		A A	C	226111
25 5/8	18 1/8	2 5/8	JAGUAR		VT	C	4	12	GR GR	3 1/4 3 1/4	18 1/4 18 1/4	C C		A A	N	128121
25 5/8	24 3/4	3 3/4	CASE/INTERNATIONAL		T	C	5	8	BL BL	6 5/8 6 5/8	27 1/2 27 1/2	1 1/4 1 1/4	34 34	A A	C	272788
25 5/8	25 5/16	2 1/4	DODGE TRK	C800-900, D800	T	C	3	10	GR GR	4 3	25 3/4 25 3/4	3/8 C		A A	C	262977
25 5/8	25 5/16	3	DODGE TRK		T	C	4	11	GR GR	3 1/4 3 1/4	25 5/8 25 5/8	C C		A A	C	223104
25 3/4	9 7/8	1 1/4	FIAT		VT	C	2	12		1 3/4 1 3/4	10 1/4 10 1/4	C C		0 0	N	124751
25 3/4	17 5/8	2	LINCOLN		VT	C	3	12	GR GR	2 5/8 2 5/8	17 1/2 17 1/2	C C		A A	N	122406
25 3/4	18 1/8	2	JAGUAR		VT	C	3	12	GR GR	3 1/8 3 1/8	18 18	C C		A A	N	124615
25 3/4	20 5/8	2 7/8	PACKARD		S	C	5	10	GR GR	3 3/8 3 3/8	20 1/4 20 1/4	C C		A A	C	265927
25 3/4	22 1/2	3 3/4	LIFT TRUCKS & LOADERS	MICHIGAN	T	C	5	9	GR GR	4 1/2 4 1/2	23 1/8 23 1/8	C C		A A	C	261857
25 3/4	22 1/2	3 3/4	LIFT TRUCKS & LOADERS	MICHIGAN	X	C	5	8	GR GR	4 1/2 4 1/2	23 1/8 23 1/8	3/16 3/16		A A	C	288681
25 3/4	25	3	GALION		X	C	4	11	GR GR	3 1/2 3 1/2	25 3/4 25 3/4	C C		A A	C	221858
25 3/4	25 5/16	3	GALION		T	C	4	11	GR GR	3 1/2 3 1/2	25 3/4 25 3/4	C C		A A	C	279218
25 3/4	25 5/16	3	INGERSOLL-RAND		T	C	4	10	GR GR	3 7/16 3 7/16	25 3/4 25 3/4	C C		A A	C	279282
25 3/4	25 5/8	2 3/8	INGERSOLL-RAND	59695692	S	C	4	9	GR GR	3 7/16 3 7/16	25 3/4 25 3/4	1/4 1/4		A A	C	229082
25 3/4	25 5/8	2 7/8	INGERSOLL-RAND	175-250 59624320, 59970954	S	C	5	10	GR GR	3 7/16 3 7/16	25 3/4 25 3/4	C C		A A	C	229083
25 3/4	27 1/2	3 11/16	JOHN DEERE	GD544	Z	C	5	6	GR GR	4 1/4 4 1/4	28 1/4 28 1/4	C C		A A	C	281920
25 3/4	27 1/2	3 11/16	LIFT TRUCKS & LOADERS	YALE	Z	C	5	10	BL BL	7 3/8 7 3/8	30 30	1 7/8 1 7/8	40 40	A A	C	281666
25 3/4	27 9/16	3 3/4	JOHN DEERE	GD544	T	C	5	6	GR GR	4 1/4 4 1/4	28 1/4 28 1/4	C C		A A	C	265678
25 7/8	13 3/4	2 3/8	GARDNER DENVER	100-150 COMPRESSOR	S	C	4	11	GR GR	3 1/4 3 1/4	14 1/4 14 1/4	C C		A A	C	229072
25 7/8	26 1/4	3 7/16	FIAT ALLIS	8070 TRACTOR 264229	S	C	6	10	GR GR	4 1/4 4 1/4	26 5/8 26 5/8	1/8 1/8		A A	C	229192
25 7/8	26 1/2	3 3/4	FIAT ALLIS	7080	B	C	5	7	GR GR	3 7/8 3 7/8	26 5/8 26 5/8	C C		A A	C	272779
25 7/8	29 1/2	3 3/4	CASE/INTERNATIONAL	825 SKIDDER	B	C	5	7	GR GR	4 7/8 4 7/8	29 3/4 29 3/4	C C		A A	C	278787
25 15/16	20 5/8	2 15/16	CATERPILLAR	12 GRADER 8F3136 HVY BTM HDR	Z	C	4	6	BL BH	5 3/4 5 3/4	28 5/8 28 5/8	C C	28 28	H H	C	225235

Vista-Pro Automotive - Core Catalog
(Cores Sorted by Size)

Height	Width	Depth	Application	Description	Fin Type	Fin Matl	Rows	FPI	BH / TH Type	BH / TH Width	BH / TH Length	BH / TH OHF	BH / TH Bolts	BH / TH Shape	Hdr Support	Model #
25 15/16	20 13/16	3	CATERPILLAR	12 GRADER OFFSET FOR O/C	T	C	4	7	BL	5 3/4	28 5/8	C		H	C	270095
									BL	5 3/4	28 5/8	C	28	H		
26	15 15/16	2 5/8	JAGUAR		VT	C	4	12	GR	3 1/16	16	C		A	N	128360
									GR	3 1/16	16	C		A		
26	17 1/16	2 5/8	CHEVROLET	CORVETTE	VT	C	4	12	GR	3 1/2	18 5/8	C		A	N	122599
									GR	3 7/16	18 5/8	C		A		
26	18 1/8	1 1/4	FORD		VT	C	2	14	GR	3 3/8	18 7/8	1 7/16		A	N	124502
									GR	2 13/16	18 7/8	1 7/16		A		
26	18 1/8	2	FORD		VT	C	3	12	GR	2 13/16	18 7/8	1/4		A	N	124511
									GR	3 3/8	18 7/8	3/4		A		
26	18 1/8	2 5/8	FORD		VT	C	4	12	GR	2 13/16	18 7/8	C		A	N	122610
									GR	3 3/8	18 7/8	C		A		
26	24 3/8	3 11/16	LIFT TRUCKS & LOADERS	MICHIGAN 85A	Z	C	5	8	GR	6 1/8	25 1/4	3/16		A	C	282692
									GR	4 1/2	24 3/4	3/16		A		
26	25 7/8	4 1/2	CRANE CARRIER		T	C	6	8	BL	7 1/4	27 7/8	C	42	A	C	223084
									BL	7 1/4	27 7/8	C	42	A		
26	26 1/4	2 7/8	CRANE CARRIER		R	C	5	8	BL	7 1/4	27 7/8	C	42	A	C	226400
									BL	7 1/4	27 7/8	C	42	A		
26	26 1/4	3	JOHN DEERE	SCRAPER	X	C	4	7	GR	4 1/8	27 1/4	1/4		A	C	266305
									GR	4 1/8	27 1/4	1/4		A		
26	27 1/2	2 3/16	CATERPILLAR	D-4D 5S8052 HVY T/BTM HDRS HVY STEEL FINS 4 CRNRS OF CORE NOTCHED	Z	S	3	6	BH	5 3/4	29 3/8	C	32	F	C	225857
									BH	5 3/4	29 3/8	C	32	F		
26	27 1/2	2 15/16	CATERPILLAR	D-4 5S4592 HVY T/BTM HDRS 4 CRNRS OF CORE NOTCHED	Z	C	4	9	BH	5 3/4	29 3/8	C	32	F	C	225238
									BH	5 3/4	28 7/8	C	32	F		
26	27 1/2	3	CATERPILLAR	D-4 HVY T/BTM HDRS	B	C	4	7	BH	5 3/4	29 3/8	C	32	A	C	278807
									BH	5 3/4	29	C	32	A		
26	27 1/2	3 3/4	CATERPILLAR	D-4 HVY T/BTM HDRS BRASS FINS	B	B	5	6	BH	5 3/4	29 3/8	C	32	A	C	229585
									BH	5 3/4	29	C	32	A		
26	27 9/16	3	CATERPILLAR	D-4 HVY T/BTM HDRS BRASS FINS	T	B	4	9	BH	5 3/4	29 3/8	C	32	A	C	264351
									BH	5 3/4	29	C	32	A		
26	28 1/8	2 1/4	LIFT TRUCKS & LOADERS	HOUGH	X	C	3	11	BL	6 3/8	31 1/8	1 5/16	36	F	C	289977
									BL	6 3/8	31 1/8	1 5/16	36	F		
26	28 3/4	4 7/16	CATERPILLAR	7N561 BRASS FINS	Z	B	6	9	GR	6	29 1/2	C		A	C	225240
									GR	6	29 1/2	C		A		
26 1/8	22 1/2	1 1/4	INGERSOLL-RAND		R	C	2	10	GR	3 5/8	24 1/4	1/4		A	C	226514
									GR	3 5/8	24 1/4	1/4		A		
26 1/8	23 1/8	1 3/4	DAVEY COMPRESSOR	185 CFM COMPRESSOR C-63345	S	C	3	7	GR	3	23 15/16	C		A	C	229040
									GR	3	23 15/16	C		A		
26 1/8	23 1/8	4 7/16	LIFT TRUCKS & LOADERS	TROYAN BRASS FINS	Z	B	6	7	BL	7 5/8	26 1/8	1 3/4	36	A	C	289592
									BL	7 5/8	26 1/8	1 3/4	36	A		
26 1/8	30	3 15/16	CASE/INTERNATIONAL	4690 TRACTOR A-149542	S	C	7	8	GR	4 7/16	31 1/16	C		A	C	229165
									GR	4 7/16	31 1/16	C		A		
26 1/4	13 3/16	1 1/4	NISSAN-STANZA		VT	C	2	15	GR	1 7/8	13	C		A	N	128702
									GR	1 7/8	13	C		A		
26 1/4	13 3/4	2 3/8	ATLAS COPCO	175 CFM 13100310 71	S	C	4	10	GR	3 1/4	14 1/4	C		A	C	229136
									GR	3 1/4	14 1/4	C		A		
26 1/4	18 1/8	3 3/4	CASE/INTERNATIONAL	1030	X	C	5	8	GR	5	18 3/8	C		A	C	266168
									GR	4	18 3/8	C		A		
26 1/4	18 1/8	3 3/4	CASE/INTERNATIONAL	1370	X	C	5	9	GR	5	18 3/8	3/16		A	C	289166
									GR	4	18 3/8	3/16		A		
26 1/4	20 5/8	2 7/8	MACK TRUCKS		R	C	5	10	GR	8	21 1/8	13/16		A	C	226566
									GR	3 15/16	21 1/8	13/16		A		
26 1/4	23 1/8	4 7/16	LIFT TRUCKS & LOADERS	TROYAN TRACTOR BRASS FINS	Z	B	6	10	BL	7 5/8	26 1/4	C	40	A	C	282597
									BL	7 5/8	26 1/4	C	40	A		
26 1/4	25 7/8	2 5/8	INTERNATIONAL		VT	C	4	14	GR	4	26 3/4	1/4		A	N	128481
									GR	4	26 3/4	1/4		A		
26 1/4	26 1/4	2 7/8	NAVISTAR		R	C	5	9	GR	4	26 7/8	3/16		A	C	226635
									GR	4	26 7/8	3/16		A		
26 1/4	26 1/4	3 7/16	NAVISTAR	1910B	R	C	6	11	GR	3 7/8	26 3/4	3/16		A	C	226169
									GR	3 7/8	26 3/4	3/16		A		
26 1/4	26 7/16	3 3/4	NAVISTAR	CO1910B	T	C	5	11	GR	3 7/8	26 3/4	1/4		A	C	265621
									GR	3 7/8	26 3/4	1/4		A		
26 1/4	27 1/2	2 3/8	CASE/INTERNATIONAL	A-184453, A-189085, A-190657	S	C	4	9	GR	4 3/4	28 1/4	7/8		A	C	229160
									GR	4 3/4	28 1/4	7/8		A		

Vista-Pro Automotive - Core Catalog
(Cores Sorted by Size)

Height	Width	Depth	Application	Description	Fin Type	Fin Matl	Rows	FPI	BH / TH Type	BH / TH Width	BH / TH Length	BH / TH OHF	BH / TH Bolts	BH / TH Shape	Hdr Support	Model #
26 1/4	27 1/2	2 7/8	CASE/INTERNATIONAL	1085-C A-189217, A-189087	S	C	5	8	GR GR	4 3/4 4 3/4	28 1/4 28 1/4	C C		A A	C	229161
26 1/4	27 1/2	3 7/16	CASE/INTERNATIONAL	2590, 2390 A-189089 A-172192	S	C	6	9	GR GR	4 3/4 4 3/4	28 1/4 28 1/4	3/8 3/8		A A	C	229162
26 1/4	27 1/2	3 15/16	CASE/INTERNATIONAL	A-189091 A-190663	S	C	7	9	GR GR	4 3/4 4 3/4	28 1/4 28 1/4	C C		A A	C	229163
26 1/4	27 1/2	4 7/16	CASE/INTERNATIONAL	621 LOADER A-190619 BRASS FINS	Z	B	6	7	GR GR	4 3/4 4 3/4	28 1/4 28 1/4	C C		A A	C	225002
26 1/4	28 1/8	3 7/16	BROCKWAY		R	C	6	11	BL BL	7 3/8 7 3/8	30 1/4 30 1/4	C C	42 42	A A	C	226300
26 3/8	13 3/16	1 1/4	DATSUN		VT	C	2	14	GR GR	1 15/16 2 5/8	13 1/8 13 1/8	C C		A A	N	128283
26 3/8	16 15/16	1	GM	VE CORE;2R-17 FPI	VE	C	2	17	GR GR	2 3/8 2 3/8	18 5/8 18 5/8	C C		A A	N	128182
26 3/8	16 15/16	1 9/16	GM		VE	C	3	14	GR GR	2 3/4 2 3/4	18 5/8 18 5/8	7/16 7/16		A A	N	128211
26 3/8	16 15/16	1 9/16	GM	VE CORE;3R-17 FPI	VE	C	3	17	GR GR	2 3/8 2 3/8	18 5/8 18 5/8	C C		A A	N	128183
26 3/8	16 15/16	1 9/16	GM		VE	C	3	14	GR GR	2 3/4 2 1/16	18 5/8 18 5/8	3/8 C		A A	N	122332
26 3/8	17 1/16	1 1/4	BUICK		VT	C	2	12	GR GR	2 3/4 2 3/4	18 5/8 18 5/8	C C		A A	N	122520
26 3/8	17 1/16	1 1/4	BUICK		VT	C	2	13	GR GR	2 3/4 2 1/16	18 5/8 18 5/8	3/8 C		A A	N	124897
26 3/8	17 1/16	1 1/4	GM		VT	C	2	16	GR GR	2 3/4 2 3/4	18 5/8 18 5/8	C C		A A	N	128779
26 3/8	17 1/16	1 1/4	GM		VT	C	2	12	GR GR	3 1/2 2 3/4	18 5/8 18 5/8	C C		A A	N	122441
26 3/8	17 1/16	1 1/4	GM		VT	C	2	12	GR GR	3 1/2 2 3/4	18 5/8 18 5/8	C 3/8		A A	N	124501
26 3/8	17 1/16	1 1/4	GM		VT	C	2	14	GR GR	2 3/8 2 3/8	18 5/8 18 5/8	7/16 7/16		A A	N	128149
26 3/8	17 1/16	2	GM	Reg. plant model	VT	C	3	12	GR GR	2 3/4 2 3/4	18 5/8 18 5/8	C C		A A	N	122521
26 3/8	17 1/16	2	PONTIAC		VT	C	3	12	GR GR	3 1/2 2 3/4	18 5/8 18 5/8	3/8 3/8		A A	N	122443
26 3/8	17 1/16	2	GM		VT	C	3	12	GR GR	2 1/16 2 3/4	18 5/8 18 5/8	C C		A A	N	122633
26 3/8	17 1/16	2	GM		VT	C	3	14	GR GR	2 3/8 2 3/8	18 5/8 18 5/8	C C		A A	N	128198
26 3/8	17 1/16	2 5/8	PONTIAC		VT	C	4	12	GR GR	3 1/2 3 1/2	18 5/8 18 5/8	C C		A A	N	122445
26 3/8	17 1/16	2 5/8	GM		VT	C	4	16	GR GR	2 3/4 2 3/4	18 5/8 18 5/8	C C		A A	N	128355
26 3/8	17 1/16	2 5/8	GM		VT	C	4	14	GR GR	3 3/4 3 3/4	18 5/8 18 5/8	C C		A A	N	128459
26 3/8	17 1/16	2 5/8	GM		VT	C	4	12	GR GR	2 3/4 2 3/4	18 5/8 18 5/8	C C		A A	N	128732
26 3/8	19 1/4	2 5/8	CHEVROLET		VT	C	4	12	GR GR	3 1/2 3 1/2	20 7/8 20 7/8	C C		A A	N	122655
26 3/8	19 1/4	2 5/8	GM		VT	C	4	12	GR GR	3 1/2 3 1/2	20 7/8 20 7/8	C C		A A	N	124879
26 3/8	20	2 15/16	CATERPILLAR	GRADER BRASS FINS	Z	B	4	9	GR GR	3 1/2 3 1/2	22 22	C C		A A	C	225139
26 3/8	22 1/2	2 1/4	LIFT TRUCKS & LOADERS	MICHIGAN	X	C	3	8	GR GR	4 1/2 4 1/8	23 1/4 23 1/4	1/4 1/4		A A	C	287398
26 3/8	24 3/16	1 1/4	CHEV/GMC	CHEV TRK	VT	C	2	12	GR GR	2 3/4 2 3/4	25 3/4 25 3/4	3/8 3/8		A A	N	122527
26 3/8	24 3/16	2	CHEV/GMC	CHEV TRK	VT	C	3	12	GR GR	2 3/4 2 3/4	25 3/4 25 3/4	C C		A A	N	122550
26 3/8	25	2 7/8	FORD TRACTOR	495 COMBINE 594118	S	C	5	6	GR GR	3 1/4 3 1/4	25 5/8 25 5/8	C C		A A	C	229132
26 3/8	25 1/2	3	FORD TRACTOR	COMBINE 495	B	C	4	6	GR GR	3 1/4 3 1/4	25 5/8 25 5/8	C C		A A	C	279850

Vista-Pro Automotive - Core Catalog
(Cores Sorted by Size)

Height	Width	Depth	Application	Description	Fin Type	Fin Matl	Rows	FPI	BH / TH Type	BH / TH Width	BH / TH Length	BH / TH OHF	BH / TH Bolts	BH / TH Shape	Hdr Support	Model #
26 7/16	29 1/4	4 1/2	GROVE WORLDWIDE		T	C	6	9	GR	5 3/8	29 7/8	1/8		A	C	223243
									GR	5 3/8	29 7/8	1/8	A			
26 7/16	31 7/8	3 11/16	EMD LOCOMOTIVE	3129239 HVY T/BTM HDRS RECESSED HDRS	T12	C	4	9	PN	6 7/8	35 3/4	C	40	A	N	225425
									PN	6 7/8	35 3/4	C	40	A		
26 1/2	20 5/8	2 1/4	JOHN DEERE	ROLLER RE33358	X	C	3	7	GR	3 1/2	22	C		A	C	221247
									GR	3 1/2	22	C	A			
26 1/2	20 5/8	2 15/16	JOHN DEERE		Z	C	4	7	GR	3 1/2	22	C		A	C	286544
									GR	3 1/2	22	C	A			
26 1/2	21 3/8	3	MACK TRUCKS	B61	T	C	4	10	GR	6	21 3/4	1/4		A	C	261291
									GR	3 3/8	21 3/4	1/4	A			
26 1/2	25	3	FIAT ALLIS	HD-9	X	C	4	6	GR	4 5/8	25 3/4	3/16		A	C	265948
									GR	3 1/8	25 3/4	3/16	A			
26 1/2	25 5/16	2 5/8	INTERNATIONAL		VT	C	4	12	GR	3 1/2	25 3/4	C		A	N	128524
									GR	3 1/2	25 3/4	C	A			
26 1/2	25 5/16	2 1/4	NAVISTAR	1850 DIESEL	T	C	3	10	GR	3 1/2	25 3/4	C		A	C	265603
									GR	3 1/2	25 3/4	C	A			
26 1/2	25 5/16	3	NAVISTAR	D1900	T	C	4	10	GR	3 1/2	25 3/4	C		A	C	264085
									GR	3 1/2	25 3/4	C	A			
26 1/2	25 5/8	1 1/4	NAVISTAR	1700-1800 LOADSTAR	R	C	2	8	GR	2 1/2	26 1/4	C		A	C	226171
									GR	2 1/2	26 1/4	C	A			
26 1/2	25 5/8	1 3/4	NAVISTAR		R	C	3	11	GR	2 1/4	25 3/4	C		A	C	226172
									GR	2 1/4	25 3/4	C	A			
26 1/2	25 5/8	1 3/4	NAVISTAR	1600-1800	R	C	3	8	GR	2 7/16	26 1/8	7/16		A	C	226173
									GR	2 7/16	26 1/8	7/16	A			
26 1/2	25 5/8	1 3/4	NAVISTAR		S	C	3	10	GR	2 1/2	26 1/4	C		A	C	266408
									GR	2 1/2	26 1/4	C	A			
26 1/2	25 5/8	2 3/8	MERCEDES BENZ TRUCK	1390	R	C	4	11	GR	3	26 5/8	C		A	C	226625
									GR	3	26 5/8	C	A			
26 1/2	25 5/8	2 3/8	NAVISTAR	1850 DIESEL	R	C	4	11	GR	3 1/2	25 7/8	C		A	C	226636
									GR	3 1/2	25 7/8	C	A			
26 1/2	25 5/8	2 7/8	NAVISTAR		R	C	5	9	GR	3 1/2	25 7/8	C		A	C	226637
									GR	3 1/2	25 7/8	C	A			
26 1/2	25 5/8	3 7/16	FORD TRUCK		S	C	6	7	GR	4 1/4	26 1/4	C		A	C	266219
									GR	4 1/4	26 1/4	C	A			
26 1/2	25 7/8	2	INTERNATIONAL		VT	C	3	12	GR	3 1/8	26	5/8		A	N	122222
									GR	3 1/8	26	5/8	A			
26 1/2	25 7/8	2	INTERNATIONAL		VT	C	3	12	GR	2 1/4	25 3/4	3/16		A	N	124404
									GR	2 1/4	25 3/4	3/16	A			
26 1/2	25 7/8	2	INTERNATIONAL		VT	C	3	12	GR	2 1/2	26 3/8	1/4		A	N	124928
									GR	2 1/2	26 3/8	1/4	A			
26 1/2	25 7/8	2 1/4	NAVISTAR	1600-1800	T	C	3	11	GR	2 1/2	26 1/4	C		A	C	263247
									GR	2 1/2	26 1/4	C	A			
26 1/2	26 1/4	3	DETROIT DIESEL		X	C	4	8	GR	4	26 7/8	7/8		A	C	288603
									GR	4	26 7/8	7/8	A			
26 1/2	26 3/8	1 1/4	INTERNATIONAL		VT	C	2	12	GR	2 1/2	26 3/8	3/16		A	N	128103
									GR	2 1/2	26 3/8	3/16	A			
26 1/2	28 11/16	3	CATERPILLAR	D330	T	C	4	9	GR	4	29 1/2	1/4		A	C	223624
									GR	4	29 1/2	1/4	A			
26 9/16	25 5/8	3 7/16	FORD TRACTOR	D6NN-8005-G	S	C	6	8	GR	4 1/4	26 1/4	C		A	C	229053
									GR	4 1/4	26 1/4	C	A			
26 9/16	25 5/8	3 3/4	FORD TRACTOR	8A66 WHEEL LOADER	X	C	5	8	GR	4 3/16	26 3/8	C		A	C	266215
									GR	4 3/16	26 3/8	C	A			
26 9/16	25 5/8	3 15/16	FORD TRACTOR	D6NN-8005-H	S	C	7	8	GR	4 1/4	26 1/4	C		A	C	229054
									GR	4 1/4	26 1/4	C	A			
26 9/16	29 3/8	5 3/16	EMD LOCOMOTIVE	3129131 HVY T/BTM HDRS RECESSED BRASS FINS	T12	C	6	10	PN	9	33 3/4	C	40	A	N	286816
									PN	9	33 3/4	C	40	A		
26 5/8	21 7/8	3 11/16	JOHN DEERE	4240	Z	C	5	9	GR	4 1/4	22	1/8		A	C	273629
									GR	4 1/4	22	1/8	A			
26 5/8	24 3/8	3	WAUKESHA	MZ	X	C	4	7	BL	6 5/8	27 1/4	C	32	H	C	274897
									BL	6 5/8	27 1/4	C	32	H		
26 5/8	24 3/4	3 3/4	WAUKESHA	GK-135	T	C	5	7	BL	6 5/8	27 1/4	C	32	H	C	223316
									BL	6 5/8	27 1/4	C	32	H		
26 5/8	25	3 11/16	KOMATSU	HVY STEEL FINS	Z	S	5	9	GR	4 1/4	25	C		A	C	225934
									GR	4 1/4	25	C	A			

Vista-Pro Automotive - Core Catalog
(Cores Sorted by Size)

Height	Width	Depth	Application	Description	Fin Type	Fin Matl	Rows	FPI	BH / TH Type	BH / TH Width	BH / TH Length	BH / TH OHF	BH / TH Bolts	BH / TH Shape	Hdr Support	Model #
26 5/8	25 5/16	2	INTERNATIONAL		VT	C	3	12	GR	2 3/8 2 3/8	25 3/4 25 3/4	C		A	N	124929
26 5/8	25 7/8	2 1/4	NAVISTAR	16001800	T	C	3	11	GR	2 7/16 2 7/16	26 1/8 26 1/8	C		A	C	274967
26 5/8	27 1/2	2 7/8	CASE/INTERNATIONAL	2470 A-75526	S	C	5	8	GR	4 1/4 4 1/4	28 1/4 28 1/4	C		A	C	229148
26 5/8	27 1/2	3 7/16	CASE/INTERNATIONAL	4490 A-166306	S	C	6	9	GR	4 1/4 4 1/4	28 1/4 28 1/4	C		A	C	229166
26 5/8	27 1/2	3 3/4	CASE/INTERNATIONAL		B	C	5	10	GR	4 1/4 4 1/4	28 1/4 28 1/4	C		A	C	229524
26 5/8	30	3 15/16	CASE/INTERNATIONAL	2670 TRACTOR A-160204	S	C	7	8	GR	4 3/8 4 3/8	31 1/16 31 1/16	C		A	C	229167
26 5/8	30 3/8	3 3/4	CASE/INTERNATIONAL	2670 TRACTOR	T	C	5	10	GR	4 3/8 4 3/8	31 1/16 31 1/16	C		A	C	278789
26 3/4	20 5/8	2 3/8	MACK TRUCKS	MB-401	R	C	4	9	GR	8 3/8 3 5/8	21 1/2 21 1/2	3/8 3/8		A	C	226567
26 3/4	21 7/8	2 7/8	JOHN DEERE		S	C	5	8	GR	4 1/4 4 1/4	22 22	1/8 1/8		A	C	272900
26 3/4	21 7/8	3	JOHN DEERE	4240	X	C	4	8	GR	4 1/4 4 1/4	22 22	C		A	C	282571
26 3/4	21 7/8	3 7/16	JOHN DEERE	4240 RE21898	S	C	6	9	GR	4 1/4 4 1/4	22 22	3/16 3/16		A	C	229020
26 3/4	24	3	CATERPILLAR	D-6 HVY T/BTM HDRS BRASS FINS FACE DIPPED T/HDR OFFSET	B	B	4	7	BH	8 1/2 6 9/16	33 24 1/8	2 3/8 C	28 24	Z A	C	278809
26 3/4	24	3 3/4	CATERPILLAR	D-6 POWER SHIFT 8H4432 HVY T/BTM HDRS BRASS FINS	B	B	5	7	BH	8 1/2 6 9/16	33 24 1/8	2 3/8 C	28 24	Z A	C	229586
26 3/4	24 3/8	2 15/16	CATERPILLAR	D-6 6H9008 HVY T/BTM HDRS 2 BTM CRNRS OF CORE NOTCHED	Z	C	4	8	BH	8 1/2 6 9/16	33 24 1/8	2 3/8 C	28 24	Z F	C	225241
26 3/4	24 3/8	3 11/16	CATERPILLAR	D-6 POWER SHIFT 8H4432 HVY T/BTM HDRS 2 BTM CRNRS OF CORE NOTCHED	Z	C	5	7	BH	8 1/2 6 9/16	33 24 1/8	2 3/8 C	28 24	Z F	C	225186
26 3/4	25 5/8	1 3/4	NAVISTAR	1700	R	C	3	9	GR	3 3	26 26	C		A	C	226174
26 3/4	25 7/8	2 5/8	INTERNATIONAL		VT	C	4	12	GR	3 1/8 3 1/8	26 1/8 26 1/8	C		A	N	128679
26 3/4	26 1/4	2 3/16	CATERPILLAR	D-6 2M4798 HVY T/BTM HDRS 4 CRNRS OF CORE NOTCHED	Z	C	3	9	BH	5 7/16 5 7/16	27 7/16 27 7/16	C	26	F	C	225242
26 3/4	26 1/4	2 7/8	NAVISTAR	1800-1900	R	C	5	11	GR	3 3/8 3 3/8	26 7/8 26 7/8	3/16 3/16		A	C	226175
26 3/4	26 1/4	2 15/16	CATERPILLAR	D-6, 561 2S739 HVY T/BTM HDRS BRASS FINS 4 CRNRS OF CORE NOTCHED	Z	B	4	7	BH	5 7/16 5 7/16	27 7/16 27 7/16	C	26	F	C	225134
26 3/4	26 7/16	3	CATERPILLAR	D-6 HVY T/BTM HDRS BRASS FINS 4 CRNRS OF CORE NOTCHED	T	B	4	6	BH	5 7/16 5 7/16	27 7/16 27 7/16	C	26	F	C	265028
26 3/4	26 1/2	3	CATERPILLAR	D-6 2S739 HVY T/BTM HDRS BRASS FINS FACE DIPPED 4 CRNRS OF CORE NOTCHED	B	B	4	7	BH	5 7/16 5 7/16	27 7/16 27 7/16	C	26	F	C	229522
26 3/4	26 1/2	3	CATERPILLAR	D-6 2S739 HVY T/BTM HDRS BRASS FINS 4 CRNRS OF CORE NOTCHED	B	B	4	7	BH	5 7/16 5 7/16	27 7/16 27 7/16	C	26	F	C	229587
26 3/4	27	3	CATERPILLAR	613 SCRAPER BRASS FINS	B	B	4	7	GR	4 1/4 4 1/4	28 28	C		A	C	272557
26 3/4	27 1/2	3	CASE/INTERNATIONAL	2470 TRACTOR	X	C	4	8	GR	4 1/4 4 1/4	28 1/2 28 1/2	C		A	C	221802
26 3/4	27 1/2	3	CASE/INTERNATIONAL	2470 TRACTOR	X	C	4	7	GR	4 1/4 4 1/4	28 1/2 28 1/2	C		A	C	265898
26 3/4	27 9/16	3	CASE/INTERNATIONAL	2470 TRACTOR	T	C	4	8	GR	4 1/4 4 1/4	28 1/2 28 1/2	C		A	C	223108
26 3/4	28 11/16	2 1/4	CATERPILLAR	D330A 4L2114	T	C	3	9	GR	4 4	29 1/2 29 1/2	C		A	C	265645
26 3/4	28 11/16	3 3/4	CATERPILLAR	D330A	T	C	5	7	GR	4 4	29 5/8 29 5/8	C		A	C	223042
26 3/4	28 3/4	2 3/8	CATERPILLAR	D330A 4L2114	S	C	4	9	GR	4 4	29 1/2 29 1/2	C		A	C	223020
26 3/4	28 3/4	3 11/16	CATERPILLAR	D330A	Z	C	5	11	GR	4 4	29 1/2 29 1/2	C		A	C	225350
26 3/4	29 3/8	2 3/8	FORD TRUCK	C7000-8000	R	C	4	11	GR	3 1/2 3 1/2	29 1/8 29 1/8	3/16 3/16		A	C	226487

Vista-Pro Automotive - Core Catalog
(Cores Sorted by Size)

Height	Width	Depth	Application	Description	Fin Type	Fin Matl	Rows	FPI	BH / TH Type	BH / TH Width	BH / TH Length	BH / TH OHF	BH / TH Bolts	BH / TH Shape	Hdr Support	Model #
26 7/8	28 3/4	4 7/16	GROVE WORLDWIDE	BRASS FINS	Z	B	6	9	GR	5 3/8	29 5/8	5/16		A	C	286568
									GR	5 3/8	29 5/8	5/16	A			
26 7/8	33 3/4	4 1/2	CHAMPION	GRADER HVY T/BTM HDRS	T	C	6	8	BH	7	36 3/8	C	44	A	C	272823
									BH	7	36 3/8	C	44	A		
27	20 5/8	2 3/8	MACK TRUCKS	B61	R	C	4	9	GR	8	21 1/8	3/16		A	C	226569
27	20 5/8	2 3/8	MACK TRUCKS	B SERIES X-947-3E X-971-1E	R	C	4	9	GR	8 3/8	21 1/2	1/4		A	C	226571
									GR	3 5/8	21 1/2	1/4	A			
27	20 5/8	3	OLIVER HART PARR		X	C	4	9	GR	6	22	1/4		A	C	286364
27	20 13/16	3	MACK TRUCKS	B61	T	C	4	9	GR	8 3/8	21 1/2	1/4		A	C	261987
									GR	3 5/8	21 1/2	1/4	A			
27	20 13/16	3	MACK TRUCKS		T	C	4	9	GR	6 7/8	21 3/4	3/8		A	C	261994
27	21 1/4	2 7/8	MACK TRUCKS	B61	R	C	5	9	GR	3 5/8	21 3/4	C		A	C	226206
									GR	8	21 1/4	3/16	A			
27	21 1/4	2 7/8	MACK TRUCKS	B61	R	C	5	10	GR	8 3/8	21 1/2	1/8		A	C	226570
									GR	3 5/8	21 1/2	1/8	A			
27	21 1/4	2 7/8	WAUKESHA		S	C	5	10	BL	5 3/8	24	C	30	A	C	272962
									BL	5 3/8	24	C	30	A		
27	21 1/4	3	JOHN DEERE	4430	X	C	4	9	GR	5 7/8	21 3/4	C		A	C	289524
									GR	4 1/4	21 3/4	C	A			
27	21 1/4	3 7/16	JOHN DEERE	4430	S	C	6	9	GR	5 7/8	21 3/4	C		A	C	229021
									GR	3 7/8	21 3/4	C	A			
27	21 3/8	3	WAUKESHA	VGR-220, VGR-330	T	C	4	8	BL	5 3/8	24	C	36	A	C	272533
									BL	5 3/8	24	C	36	A		
27	21 3/8	3 3/4	JOHN DEERE	4430	T	C	5	10	GR	5 7/8	21 3/4	1 3/4		A	C	278955
									GR	3 7/8	21 3/4	C	A			
27	21 7/8	3 11/16	JOHN DEERE	4430	Z	C	5	10	GR	5 7/8	21 3/4	1 1/8		A	C	225534
									GR	3 7/8	21 3/4	C	A			
27	25 5/16	3 3/4	AJAX	11 X 14 CMA	T	C	5	8		6 3/4	25 3/4	1/4		0	C	223027
										6	25 3/4	1/4	0			
27	25 5/8	2 3/8	NAVISTAR	1800	R	C	4	11	GR	3	26	C		A	C	226176
									GR	3	26	C	A			
27	26 1/4	2 3/8	NAVISTAR		R	C	4	11	GR	3	26 1/4	C		A	C	226638
									GR	3	26 1/4	C	A			
27	26 1/4	2 3/8	NAVISTAR	6" X 6" CRANK BOX	R	C	4	11	GR	3	26 1/4	C		A	C	226842
									GR	3	26 1/4	C	A			
27	27	2 1/4	BUCYRUS ERIE		T	C	3	7	BL	6 1/2	29	1 1/4	38	A	C	223059
									BL	6 1/2	29	1 1/4	38	A		
27	27	3 3/4	BUCYRUS ERIE	CRANE HVY T/BTM HDRS	T	C	5	8	BH	6 1/2	29	C	38	A	C	223060
									BH	6 1/2	29	C	38	A		
27	27 1/2	3 7/16	CASE/INTERNATIONAL	A-50914	S	C	6	8	GR	4 1/4	28 1/4	1/4		A	C	229168
									GR	4 1/4	28 1/4	1/4	A			
27	27 1/2	3 3/4	CASE/INTERNATIONAL		X	C	5	11	GR	4 1/4	28 1/4	C		A	C	221803
									GR	4 1/4	28 1/4	C	A			
27	27 9/16	3 3/4	CASE/INTERNATIONAL		T	C	5	10	GR	4 1/4	28 1/4	C		A	C	223109
									GR	4 1/4	28 1/4	C	A			
27	29 13/16	2 1/4	INGERSOLL-RAND	DR-250	T	C	3	9	GR	4 5/8	31 1/8	3/16		A	C	261155
									BL	4 5/8	31 1/8	3/16	A			
27	35	3 3/4	LIFT TRUCKS & LOADERS	HYSTER	X	C	5	11	GR	7 1/2	37	C	48	A	C	281678
									BL	7 1/2	37	C	48	A		
27 1/8	17 5/8	1 1/4	JAGUAR		VT	C	2	16	GR	1 3/4	17 5/8	C		A	N	124994
									GR	1 3/4	17 5/8	C	A			
27 1/8	21 3/8	3	JOHN DEERE	4430	T	C	4	9	GR	5 7/8	21 3/4	C		A	C	223208
									GR	3 7/8	21 3/4	1/8	A			
27 1/8	21 3/8	3 3/4	JOHN DEERE	4430	T	C	5	9	GR	5 7/8	21 3/4	C		A	C	223214
									GR	3 7/8	21 3/4	C	A			
27 1/8	21 1/2	3 3/4	JOHN DEERE	4430	B	C	5	7	GR	5 7/8	21 3/4	C		A	C	272757
									GR	3 7/8	21 3/4	C	A			
27 1/8	21 7/8	2 7/8	JOHN DEERE	4460	S	C	5	9	GR	5 7/8	21 3/4	1 5/8		A	C	266547
									GR	3 7/8	21 3/4	1/8	A			
27 1/8	21 7/8	3 7/16	JOHN DEERE	4440, 4050 AR102736, AR95849	S	C	6	9	GR	4 1/4	21 15/16	3/8		A	C	229041
									GR	4 1/4	21 15/16	3/8	A			

Vista-Pro Automotive - Core Catalog
(Cores Sorted by Size)

Height	Width	Depth	Application	Description	Fin Type	Fin Matl	Rows	FPI	BH / TH Type	BH / TH Width	BH / TH Length	BH / TH OHF	BH / TH Bolts	BH / TH Shape	Hdr Support	Model #
27 1/8	21 7/8	3 7/16	JOHN DEERE	4430	S	C	6	9	GR	5 7/8 3 7/8	21 3/4 21 3/4	1 3/4 1/4		A A	C	266546
27 1/8	21 7/8	3 3/4	JOHN DEERE	4430	X	C	5	9	GR	5 7/8 3 7/8	21 3/4 21 3/4	C C		A A	C	265892
27 1/8	21 15/16	3	JOHN DEERE	4430	T	C	4	9	GR	6 3 7/8	22 22	1 3/4 1/4		A A	C	223209
27 1/8	25	3 7/16	INT'L HARVESTER	3388 121845-C3	S	C	6	9	GR	4 1/4 4 1/4	25 3/4 25 3/4	C C		A A	C	229103
27 1/8	25	3 15/16	INT'L HARVESTER	3788 130814-C3	S	C	7	9	GR	4 1/4 4 1/4	25 3/4 25 3/4	C C		A A	C	229104
27 1/8	28 1/8	3 3/4	GROVE WORLDWIDE		X	C	5	11	GR	4 7/8 4 7/8	28 1/4 28 1/4	1/4 1/4		A A	C	289813
27 1/8	25 7/8	2	NAVISTAR		VT	C	3	11	GR	3 1/8 3 1/8	26 1/8 26 1/8	C C		A A	N	124889
27 1/4	9 3/8	1 3/4	TRUCK AND BUS HEATER	BLUEBIRD BUS 0557629	R	C	3	7	GR	2 1/2 2 1/2	9 9	1/4 1/4		A A	C	226730
27 1/4	20	3 11/16	OLIVER HART PARR		Z	C	5	11	GR	4 1/4 4 1/4	22 22	3/8 3/8		A A	C	282655
27 1/4	25	3 11/16	JOHN DEERE	BRASS FINS	Z	B	5	8	GR	4 1/4 4 1/4	25 7/8 25 7/8	C C		A A	C	282747
27 1/4	26 7/8	2 3/8	CASE/INTERNATIONAL		S	C	4	8	GR	5 5	28 28	C C		A A	C	266271
27 5/16	10 5/8	2 1/4	GARDNER DENVER	HVY T/BTM HDRS	X	C	3	9	BH	7	12 3/4 12 3/4	2 7/8 2 7/8	18 18	A A	C	288469
27 5/16	10 5/8	3	GARDNER DENVER	HVY T/BTM HDRS	X	C	4	6	BH	7	12 3/4 12 3/4	1 1/2 1 1/2	18 18	A A	C	260208
27 3/8	18 1/8	2 5/8	JAGUAR		VT	C	4	12	GR	3 3/16 3 3/16	18 3/16 18 3/16	C C		A A	N	124852
27 3/8	22	2 5/8	VOLVO WHITEGMC		VT	C	4	12	GR	3 7/16 3 7/16	22 1/4 22 1/4	C C		A A	N	128896
27 3/8	24	6	LIFT TRUCKS & LOADERS	CLARK SKIDDER 1913288, 1923035 HVY T/BTM HDRS BRASS FINS FACE DIPPED	B	B	8	6	BH	8 7/8 8 7/8	26 7/8 26 7/8	C C	40 40	A A	C	279691
27 3/8	24 3/8	3	CASE/INTERNATIONAL		X	C	4	9	GR	4 3/4 4 7/8	25 1/2 25 1/2	3/16 3/16		A A	C	282657
27 3/8	24 3/8	4 5/8	CASE/INTERNATIONAL		X	C	6	8	GR	4 3/4 4 7/8	25 1/2 25 1/2	C C		A A	C	266270
27 3/8	24 3/8	5 1/4	FIAT ALLIS	GLEANER COMBINE	X	C	7	8	GR	6 1/4 6 1/4	24 3/4 24 3/4	C C		A A	C	260397
27 3/8	28 3/4	3 3/4	LIMA	CRANE	X	C	5	9	BL	7 1/2 7 1/4	32 3/4 32 3/4	1 5/16 1 5/16	44 44	A A	C	289756
27 1/2	16 15/16	1 9/16	GM		VE	C	3	16	GR	2 3/4 2 3/4	18 5/8 18 5/8	C C		A A	N	128782
27 1/2	17 1/16	1 1/4	FIREBIRD		VT	C	2	12	GR	2 3/4 2 3/4	18 5/8 18 5/8	3/8 3/8		A A	N	124733
27 1/2	17 1/16	2	FIREBIRD		VT	C	3	12	GR	2 3/4 3 1/2	18 5/8 18 5/8	C C		A A	N	124570
27 1/2	17 1/16	2	FIREBIRD		VT	C	3	12	GR	2 3/4 2 3/4	18 5/8 18 5/8	C C		A A	N	124734
27 1/2	17 1/16	2	GM		VT	C	3	12	GR	3 1/2 3 1/2	18 5/8 18 5/8	C C		A A	N	128385
27 1/2	17 1/16	2	GM		VT	C	3	16	GR	2 3/4 2 3/4	18 5/8 18 5/8	C C		A A	N	128680
27 1/2	17 1/16	2 5/8	GM	Reg. plant model	VT	C	4	12	GR	3 1/2 3 1/2	18 5/8 18 5/8	C C		A A	N	124504
27 1/2	17 1/16	2 5/8	GM		VT	C	4	12	GR	2 3/4 2 3/4	18 5/8 18 5/8	C C		A A	N	122625
27 1/2	17 3/4	1 9/16	JAGUAR		VE	C	3	16	GR	2 2	17 3/4 17 3/4	C C		A A	N	122355
27 1/2	21 1/4	3	JOHN DEERE	4430	X	C	4	9	GR	6 3 7/8	21 3/4 21 3/4	C C		A A	C	286402
27 1/2	21 3/8	3	JOHN DEERE	4430	T	C	4	9	GR	6 3 7/8	21 3/4 21 3/4	C C		A A	C	278957
27 1/2	24	5 1/4	FIAT ALLIS	BALDWIN GLEANER	B	C	7	6	GR	6 1/4 6 1/4	24 3/4 24 3/4	5/8 5/8		A A	C	272780

Vista-Pro Automotive - Core Catalog
(Cores Sorted by Size)

Height	Width	Depth	Application	Description	Fin Type	Fin Matl	Rows	FPI	BH / TH Type	BH / TH Width	BH / TH Length	BH / TH OHF	BH / TH Bolts	BH / TH Shape	Hdr Support	Model #
27 1/2	24 3/8	5 3/16	FIAT ALLIS	BALDWIN GLEANER BRASS FINS	Z	B	7	6	GR	5 7/8	24 7/8	C		A	C	289866
									GR	5 7/8	24 7/8	C		A		
27 1/2	25	2 7/8	KOHLER ENGINES & GEN	80-100 KW A-273472	S	C	5	9	GR	4 5/16	25 3/4	C		A	C	229123
									GR	4 5/16	25 3/4	C		A		
27 1/2	25	3	CASE/INTERNATIONAL	W-20C LOADER	X	C	4	10	GR	3 7/8	25 3/4	3/16		A	C	282474
									GR	3 7/8	25 3/4	3/16		A		
27 1/2	25 5/8	4 7/16	CASE/INTERNATIONAL	1150-B BRASS FINS	Z	B	6	7	BL	7	28	C	42	A	C	225337
									BL	7	28	C	42	A		
27 1/2	25 7/8	4 1/2	CASE/INTERNATIONAL	1150-B	T	C	6	9	BL	7	28	C	42	A	C	265485
									BL	7	28	C	42	A		
27 1/2	26	4 1/2	CASE/INTERNATIONAL	1150-B HVY BTM HDR BRASS FINS FACE DIPPED	B	B	6	8	BL	7	28	C	42	A	C	278794
									BH	7	28	C	42	A		
27 1/2	26 1/4	2 3/8	FORD TRUCK	F600-750	R	C	4	11	GR	3	26 13/16	C		A	C	226488
									GR	3	26 13/16	C		A		
27 1/2	26 1/4	2 3/8	FORD TRUCK	LN6000-7000 W/CAT ENGINE LEVEL BKT T/HDR RD INL 8 1/2" LT	R	C	4	9	BU	5	27 3/8	1 5/16		A	C	226489
									GR	3	26 13/16	C		A		
27 1/2	26 1/4	2 7/8	FORD TRUCK	C7000-8000	R	C	5	11	GR	3	26 13/16	C		A	C	226490
									GR	3	26 13/16	C		A		
27 1/2	26 1/4	4 5/8	CASE/INTERNATIONAL	1150-B HVY T/BTM HDRS	X	C	6	7	BH	7	28	C	42	A	C	266182
									BH	7	28	C	42	A		
27 1/2	26 3/8	2	FORD TRUCK		VT	C	3	12	BU	5	27 3/8	C		A	N	124091
									GR	3	26 13/16	C		A		
27 1/2	26 3/8	2	FORD TRUCK		VT	C	3	12	GR	3	26 13/16	C		A	N	128591
									GR	3	26 13/16	C		A		
27 1/2	26 3/8	2 5/8	FORD TRUCK		VT	C	4	12	BU	5	27 3/8	C		A	N	124032
									GR	3	26 13/16	C		A		
27 1/2	26 3/8	2 5/8	FORD TRUCK		VT	C	4	12	GR	3	26 13/16	C		A	N	128132
									GR	3	26 13/16	C		A		
27 9/16	19 13/16	1 1/4	FORD TRUCK		VT	C	2	12	GR	2 7/8	20 3/4	3/8		A	N	124991
									GR	2 7/8	20 3/4	3/8		A		
27 9/16	19 13/16	2	FORD TRUCK		VT	C	3	12	GR	2 3/4	20 3/4	1/4		A	N	124985
									GR	2 3/4	20 3/4	1/4		A		
27 5/8	25	2 15/16	LIFT TRUCKS & LOADERS	HOUGH	Z	C	4	9	SQ	4 5/8	26	1		A	C	286586
									SQ	4 5/8	26	1		A		
27 5/8	25	5 3/16	LIFT TRUCKS & LOADERS	CLARK SKIDDER BRASS FINS	Z	B	7	6	SQ	6	26 1/2	C		A	C	289910
									SQ	6	26 1/2	C		A		
27 5/8	25 5/16	3	DRESSER INDUSTRIES	HOUGH H-70 LOADER	T	C	4	7	GR	4 5/8	25 3/4	3/8		A	C	265854
									GR	4 5/8	25 3/4	3/8		A		
27 5/8	26 7/8	2 7/8	VOLVO WHITEGMC	716	R	C	5	11	SQ	3 7/16	27	C		A	C	226733
									SQ	3 7/16	27	C		A		
27 3/4	20 5/8	4 7/16	DRESSER INDUSTRIES	TD-8C 653856-C91, 630266-C1 HVY T/BTM HDRS BRASS FINS	Z	B	6	10	BH	8	22 1/4	1 1/2	34	A	C	285099
									BH	7 3/8	22 1/4	1 1/2	34	A		
27 3/4	21 1/4	3	JOHN DEERE	4520, 4620	X	C	4	9	GR	6	22	C		A	C	289170
									GR	3 1/2	22	C		A		
27 3/4	21 1/4	5 3/16	CATERPILLAR	951C 4N3474 HVY T/BTM HDRS HVY STEEL FINS	Z	S	7	9	BH	7 5/16	23 11/16	C	26	F	C	225804
									BH	7 5/16	23 11/16	C	26	F		
27 3/4	21 1/2	3	JOHN DEERE	4520	B	C	4	7	GR	6	22	C		A	C	277366
									GR	3 1/2	22	C		A		
27 3/4	21 1/2	5 1/4	CATERPILLAR	951C LOADER HVY T/BTM HDRS BRASS FINS FACE DIPPED	B	B	7	7	BH	7 5/16	23 11/16	C	26	F	C	272560
									BH	7 5/16	23 11/16	C	26	F		
27 3/4	21 15/16	3	JOHN DEERE	4520	T	C	4	9	GR	6	22	C		A	C	265419
									GR	3 1/2	22	C		A		
27 3/4	25 5/8	2 15/16	CATERPILLAR	941, 951 5S8036 HVY T/BTM HDRS	Z	C	4	9	BH	7 5/16	28 3/8	C	30	F	C	225244
									BH	7 5/16	28 3/8	C	30	F		
27 3/4	25 5/8	3 11/16	CATERPILLAR	951 8S2640 HVY T/BTM HDRS BRASS FINS	Z	B	5	9	BH	7 5/16	28 3/8	C	30	F	C	225135
									BH	7 5/16	28 3/8	C	30	F		
27 3/4	25 5/8	3 11/16	CATERPILLAR	951 8S2640 HVY T/BTM HDRS HVY STEEL FINS	Z	S	5	9	BH	7 5/16	28 3/8	C	30	F	C	225805
									BH	7 5/16	28 3/8	C	30	F		
27 3/4	25 7/8	3 3/4	CATERPILLAR	941 HVY T/BTM HDRS	T	C	5	9	BH	7 5/16	28 3/8	C	30	F	F	266548
									BH	7 5/16	28 3/8	C	30	F		
27 3/4	26	3 3/4	CATERPILLAR	941, 951 POWER SHIFT 8S2640 HVY T/BTM HDRS BRASS FINS FACE DIPPED	B	B	5	6	BH	7 5/16	28 3/8	C	30	F	C	229532
									BH	7 5/16	28 3/8	C	30	F		
27 3/4	26	3 3/4	CATERPILLAR	941, 951 POWER SHIFT 8S2640 HVY T/BTM HDRS BRASS FINS	B	B	5	6	BH	7 5/16	28 3/8	C	30	F	C	229588
									BH	7 5/16	28 3/8	C	30	F		

Vista-Pro Automotive - Core Catalog
(Cores Sorted by Size)

Height	Width	Depth	Application	Description	Fin Type	Fin Matl	Rows	FPI	BH / TH Type	BH / TH Width	BH / TH Length	BH / TH OHF	BH / TH Bolts	BH / TH Shape	Hdr Support	Model #
27 3/4	26 7/16	4 1/2	CUMMINS ENGINE	DRAGLINE HVY T/BTM HDRS	T	C	6	9	BH	7 3/8	29 1/2	C	44	A	C	272784
									BH	7 3/8	29 1/2	C	44	A		
27 3/4	27 9/16	3 3/4	JOHN DEERE	TRACTOR	T	C	5	9	GR	4 1/4	28 3/16	C		A	C	265893
									GR	4 1/4	28 3/16	C		A		
27 3/4	29 3/8	2 3/8	FORD TRUCK	C700-900	R	C	4	11	GR	3 1/2	29 1/8	C		A	C	226491
									GR	3 1/2	29 1/8	C		A		
27 3/4	29 3/8	2 7/8	FORD TRUCK	C700-900	R	C	5	11	GR	3 1/2	29 1/8	C		A	C	226150
									GR	3 1/2	29 1/8	C		A		
27 3/4	40 5/8	2 3/8	AUTOCAR		R	C	4	11	BL	7 1/16	44 3/8	2 1/2	62	C	C	226180
									BL	7 1/16	44 3/8	2 1/2	62	C		
27 13/16	20 1/2	4 1/2	INT'L HARVESTER	125 LOADER HVY T/BTM HDRS BRASS FINS FACE DIPPED 15/16" BTWN HOLES 1 & 2	B	B	6	7	BH	8	22 3/8	1 3/8	34	A	C	272694
									BH	7 3/8	22 3/8	1 3/8	34	A		
27 13/16	20 1/2	4 1/2	INT'L HARVESTER	125 LOADER HVY T/BTM HDRS BRASS FINS FACE DIPPED 1 3/8" BTWN HOLES 1 & 2	B	B	6	7	BH	8	22 1/4	1 3/8	34	A	C	272695
									BH	7 3/8	22 1/4	1 3/8	34	A		
27 13/16	25	2 7/8	INT'L HARVESTER	59954-C2	S	C	5	7	GR	5 7/8	25 7/8	C		A	C	229116
									GR	5 7/8	25 7/8	C		A		
27 7/8	25 5/8	2 3/16	JOHN DEERE	5010	Z	C	3	9	GR	6	25 3/4	3/4		A	C	288642
									GR	3 1/4	25 3/4	C		A		
27 7/8	25 5/8	3	JOHN DEERE	5020, 7520	X	C	4	8	GR	6	25 3/4	3/16		A	C	289260
									GR	3 1/4	25 3/4	3/16		A		
27 7/8	26 7/8	3	MINNEAPOLIS MOLINE	800	X	C	4	8	BL	5 7/8	28 5/8	1 1/4	28	F	C	288291
									BL	5 7/8	28 5/8	1 1/4	28	F		
27 7/8	27 1/2	4 7/16	JOHN DEERE	644A SKIDDER BRASS FINS	Z	B	6	8	GR	4 3/4	28 3/8	C		A	C	289500
									GR	4 3/4	28 3/8	C		A		
27 7/8	27 1/2	4 1/2	JOHN DEERE	644A SKIDDER BRASS FINS FACE DIPPED	B	B	6	6	GR	4 3/4	28 3/8	C		A	C	278960
									GR	4 3/4	28 3/8	C		A		
27 7/8	27 9/16	4 1/2	JOHN DEERE	644A SKIDDER	T	C	6	7		4 3/4	28 3/8	C	0	0	C	265910
										4 3/4	28 3/8	C	0	0		
27 7/8	28 1/8	3 3/4	GROVE WORLDWIDE	5.22773E+12	X	C	5	9	GR	6 1/2	28 3/8	11/16		A	C	286758
									GR	4 7/8	28 3/8	11/16		A		
27 15/16	25	2 15/16	INT'L HARVESTER	COTTON PICKER 401188-R3	Z	C	4	7	GR	5 7/8	25 7/8	C		A	C	225519
									GR	5 7/8	25 7/8	C		A		
27 15/16	25	3 7/16	INT'L HARVESTER	400734-R3	S	C	6	7	GR	5 7/8	25 7/8	C		A	C	229105
									GR	5 7/8	25 7/8	C		A		
27 15/16	25	4 7/16	CASE/INTERNATIONAL	1420, 1440 COMBINE 55650-C3 107668 C3 BRASS FINS	Z	B	6	6	GR	5 7/8	25 7/8	C		A	C	225003
									GR	5 7/8	25 7/8	C		A		
27 15/16	25 5/8	2 7/8	INT'L HARVESTER	COTTON PICKER 782	S	C	5	6	GR	5 7/8	25 7/8	C		A	C	266250
									GR	5 7/8	25 7/8	C		A		
27 15/16	26 1/4	3	MINNEAPOLIS MOLINE	800, 6 CYL	X	C	4	7	BL	5 7/8	28 5/8	C	28	A	C	274469
									BL	5 7/8	28 5/8	C	28	A		
27 15/16	26 7/16	2 1/4	MINNEAPOLIS MOLINE	605-6A, 1210-12A	T	C	3	8	BL	5 7/8	28 5/8	C	28	A	C	271377
									BL	5 7/8	28 5/8	C	28	A		
28	18 1/8	1 1/4	FORD		VT	C	2	12	GR	2 13/16	18 7/8	7/16		A	N	124642
									GR	3 3/8	18 7/8	7/16		A		
28	18 1/8	2	FORD		VT	C	3	14	GR	2 13/16	18 7/8	5/16		A	N	124643
									GR	3 3/8	18 7/8	5/16		A		
28	18 1/8	2	FORD		VT	C	3	16	GR	2 13/16	18 7/8	5/16		A	N	124944
									GR	2 13/16	18 7/8	5/16		A		
28	18 1/8	2 5/8	FORD		VT	C	4	12	GR	2 13/16	18 7/8	C		A	N	122616
									GR	3 3/8	18 7/8	C		A		
28	18 1/8	2 5/8	FORD		VT	C	4	12	GR	2 13/16	18 7/8	C		A	N	122634
									GR	2 13/16	18 7/8	C		A		
28	20	4 7/16	JOHN DEERE	550 CRAWLER BRASS FINS HVY T/BTM HDRS	Z	B	6	8	BH	7 5/8	21 3/8	C	28	A	C	225214
									BH	7 5/8	21 3/8	C	28	A		
28	20	4 7/16	JOHN DEERE	550 CRAWLER HVY BTM HDR BRASS FINS	Z	B	6	9	BL	7 5/8	21 3/8	C	34	A	C	225645
									BH	7 5/8	21 3/8	C	34	A		
28	20	4 7/16	JOHN DEERE	550 CRAWLER HVY STEEL FINS	Z	S	6	8	BL	7 5/8	21 3/8	C	28	A	C	225943
									BL	7 5/8	21 3/8	C	28	A		
28	20	4 7/16	JOHN DEERE	550 CRAWLER HVY BTM HDR HVY STEEL FINS	Z	S	6	9	BL	7 5/8	21 3/8	C	34	A	C	225944
									BH	7 5/8	21 3/8	C	34	A		
28	20	4 1/2	JOHN DEERE	550 CRAWLER HVY T/BTM HDRS BRASS FINS FACE DIPPED	B	B	6	8	BH	7 5/8	21 3/8	C	34	A	C	272502
									BH	7 5/8	21 3/8	C	34	A		
28	20	4 1/2	JOHN DEERE	550 CRAWLER HVY T/BTM HDRS BRASS FINS FACE DIPPED	B	B	6	8	BH	7 5/8	21 3/8	C	28	A	C	272623
									BH	7 5/8	21 3/8	C	28	A		

Vista-Pro Automotive - Core Catalog
(Cores Sorted by Size)

Height	Width	Depth	Application	Description	Fin Type	Fin Matl	Rows	FPI	BH / TH Type	BH / TH Width	BH / TH Length	BH / TH OHF	BH / TH Bolts	BH / TH Shape	Hdr Support	Model #
28	24 3/16	2 1/4	GALION	ROLLER	T	C	3	7	GR	8	25 3/4	1/4		A	C	223143
									GR	3	25 3/4	1/4		A		
28	25 5/8	3	JOHN DEERE	5010	X	C	4	9	GR	6	25 3/4	C		A	C	289617
									GR	3 1/4	25 3/4	C		A		
28	25 7/8	3	JOHN DEERE	5010, 5020	T	C	4	7	GR	6	25 3/4	1/8		A	C	277040
									GR	3 1/4	25 3/4	1/8		A		
28	26 1/4	2 3/8	BLUE BIRD BUS		R	C	4	11	GR	8 1/4	26 7/8	1 7/16		A	C	226320
									GR	4	26 7/8	5/16		A		
28	26 1/4	2 7/8	BLUE BIRD BUS		R	C	5	10	GR	4	26 7/8	5/16		A	C	226103
									GR	4	26 7/8	5/16		A		
28	26 1/4	2 7/8	BLUE BIRD BUS		R	C	5	11	GR	8 1/4	26 7/8	1 7/16		A	C	226290
									GR	4	26 7/8	3/8		A		
28	26 1/4	2 7/8	BLUE BIRD BUS		R	C	5	11	GR	8 1/4	26 7/8	3/8		A	C	226291
									GR	4	26 7/8	3/8		A		
28	26 1/4	3 7/16	BLUE BIRD BUS		R	C	6	11	GR	4	26 7/8	5/16		A	C	226295
									GR	4	26 7/8	5/16		A		
28	26 7/16	2 1/4	MINNEAPOLIS MOLINE		T	C	3	9	BL	5 7/8	28 5/8	1 5/16	28	A	C	261710
									BL	5 7/8	28 5/8	1 5/16	28	A		
28	26 7/16	3 3/4	MINNEAPOLIS MOLINE	800	T	C	5	9	BL	5 7/8	28 5/8	C	28	A	C	263435
									BL	5 7/8	28 5/8	C	28	A		
28	26 7/8	3 11/16	JOHN DEERE	7700 COMBINE	Z	C	5	7	GR	4 1/4	28 3/8	C		A	C	225154
									GR	4 1/4	28 3/8	C		A		
28	26 7/8	3 11/16	JOHN DEERE	7700 COMBINE HVY STEEL FINS	Z	S	5	7	GR	4 1/4	28 3/8	C		A	C	225919
									GR	4 1/4	28 3/8	C		A		
28	27	3	JOHN DEERE	6000 COMBINE	B	C	4	7	GR	4 1/4	28 3/8	C		A	C	278961
									GR	4 1/4	28 3/8	C		A		
28	27	3 3/4	JOHN DEERE	6600 COMBINE AH 87820	B	C	5	6	GR	4 1/4	28 3/8	C		A	C	229517
									GR	4 1/4	28 3/8	C		A		
28	27	3 3/4	JOHN DEERE	4400 COMBINE	T	C	5	6	GR	4 1/4	28 3/8	C		A	C	265894
									GR	4 1/4	28 3/8	C		A		
28	27 1/2	2 3/16	CATERPILLAR	D-4 2P4648 HVY T/BTM HDRS BRASS FINS 4 CRNRS OF CORE NOTCHED	Z	B	3	7	BH	5 3/4	29 3/8	C	32	A	C	225245
									BH	5 3/4	28 7/8	C	32	A		
28	27 1/2	2 7/8	KOHLER ENGINES & GEN	125-180 KW A-273433	S	C	5	11	GR	4 3/4	28 1/4	C		A	C	229124
									GR	4 3/4	28 1/4	C		A		
28	27 1/2	2 15/16	CATERPILLAR	D-4E 8N3545 HVY T/BTM HDRS 4 CRNRS OF CORE NOTCHED	Z	C	4	8	BH	5 3/4	29 3/8	C	32	A	C	225246
									BH	5 3/4	28 7/8	C	32	A		
28	27 1/2	3 11/16	CATERPILLAR	D-4E 4N8779 HVY T/BTM HDRS BRASS FINS 4 CRNRS OF CORE NOTCHED	Z	B	5	9	BH	5 3/4	29 3/8	C	32	A	C	225247
									BH	5 3/4	28 7/8	C	32	A		
28	27 1/2	3 11/16	CATERPILLAR	D-4E 7N6223 HVY T/BTM HDRS HVY STEEL FINS 4 CRNRS OF CORE NOTCHED	Z	S	5	9	BH	5 3/4	29 3/8	C	32	A	C	225898
									BH	5 3/4	28 7/8	C	32	A		
28	27 1/2	3 3/4	CATERPILLAR	D-4D HVY T/BTM HDRS BRASS FINS	B	B	5	6	BH	5 3/4	29 3/8	C	32	A	C	229600
									BH	5 3/4	28 7/8	C	32	A		
28	28 11/16	3 3/4	EUCLID	TC-12 9023576 HVY BTM HDR	T	C	5	7	BL	7 1/2	32	1 1/2	42	A	C	223289
									BH	7 1/2	32	1 1/2	42	A		
28	28 11/16	4 1/2	EUCLID	TS-12 HVY BTM HDR	T	C	6	7	BL	7 1/2	32	C	42	A	C	275008
									BH	7 1/2	32	C	42	A		
28	28 3/4	3 11/16	TEREX	TS-14B HVY BTM HDR	Z	C	5	9	BL	7 1/2	32	1 3/8	42	A	C	225410
									BH	7 1/2	32	1 3/8	42	A		
28	28 3/4	4 7/16	EUCLID	TC-12 HVY BTM HDR BRASS FINS	Z	B	6	7	BL	7 1/2	32	C	42	A	C	287963
									BH	7 1/2	32	C	42	A		
28	39 1/2	4 1/2	REX	COMPACTOR HVY T/BTM HDRS	B	C	6	7	BH	7 3/4	42	C	60	A	C	272938
									BH	7 3/4	42	C	60	A		
28	47 1/2	3 11/16	EUCLID	TEREX 30B HVY T/BTM HDRS	Z	C	5	9	BH	8 1/2	51 7/8	C	50	A	C	282723
									BH	8 1/2	51 7/8	C	50	A		
28 1/8	28 3/4	3 7/16	CHEV/GMC	BUS 797246	R	C	6	8	BL	6 1/4	30 7/8	C	38	F	C	226260
									BL	6 1/4	30 7/8	C	38	F		
28 3/16	25	3 3/4	INT'L HARVESTER	COMBINE	B	C	5	6	GR	5 7/8	25 7/8	C		A	C	277396
									GR	5 7/8	25 7/8	C		A		
28 1/4	16 15/16	1	CHEV/GMC	CHEV TRK	VE	C	2	17	GR	2 3/8	18 5/8	1		A	N	128184
									GR	2 3/8	18 5/8	1		A		
28 1/4	16 15/16	1 9/16	GM		VE	C	3	14	GR	2 3/4	18 5/8	C		A	N	122337
									GR	2 1/16	18 5/8	C		A		
28 1/4	16 15/16	1 9/16	GM	Reg. plant model	VE	C	3	17	GR	2 3/8	18 5/8	C		A	N	128185
									GR	2 3/8	18 5/8	C		A		

Vista-Pro Automotive - Core Catalog
(Cores Sorted by Size)

Height	Width	Depth	Application	Description	Fin Type	Fin Matl	Rows	FPI	BH / TH Type	BH / TH Width	BH / TH Length	BH / TH OHF	BH / TH Bolts	BH / TH Shape	Hdr Support	Model #
28 1/4	16 15/16	1 9/16	GM		VE	C	3	17	GR	3 1/2	18 5/8	C		A	N	128552
									GR	3 1/2	18 5/8	C		A	N	
28 1/4	16 15/16	1 9/16	GM		VE	C	3	14	GR	2 3/4	18 5/8	C		A	N	128218
									GR	2 3/4	18 5/8	C		A	N	
28 1/4	16 15/16	2 1/4	GM		VE	C	4	14	GR	2 3/4	18 5/8	C		A	N	128756
									GR	2 3/4	18 5/8	C		A	N	
28 1/4	17 1/16	1 1/4	BUICK		VT	C	2	13	GR	2 3/4	18 5/8	3/8		A	N	122516
									GR	2 3/4	18 5/8	3/8		A	N	
28 1/4	17 1/16	1 1/4	OLDSMOBILE		VT	C	2	14	GR	3 1/2	18 5/8	3/8		A	N	122461
									GR	2 3/4	18 5/8	3/8		A	N	
28 1/4	17 1/16	1 1/4	GM		VT	C	2	12	GR	2 3/4	18 5/8	C		A	N	122575
									GR	3 1/2	18 5/8	C		A	N	
28 1/4	17 1/16	1 1/4	GM		VT	C	2	14	GR	2 3/8	18 5/8	7/16		A	N	128150
									GR	2 3/8	18 5/8	7/16		A	N	
28 1/4	17 1/16	2	CHEV/GMC	CHEV TRK	VT	C	3	12	GR	3 1/2	18 5/8	3/8		A	N	124565
									GR	3 1/2	18 5/8	3/8		A	N	
28 1/4	17 1/16	2	GM	Reg. plant model	VT	C	3	12	GR	2 3/4	18 5/8	C		A	N	122505
									GR	2 3/4	18 5/8	C		A	N	
28 1/4	17 1/16	2	GM		VT	C	3	16	GR	2 3/4	18 5/8	C		A	N	128639
									GR	2 3/4	18 5/8	C		A	N	
28 1/4	17 1/16	2	OLDSMOBILE		VT	C	3	12	GR	3 7/16	18 5/8	3/8		A	N	122409
									GR	2 3/4	18 5/8	C		A	N	
28 1/4	17 1/16	2	GM		VT	C	3	14	GR	2 3/8	18 5/8	C		A	N	128199
									GR	2 3/8	18 5/8	C		A	N	
28 1/4	17 1/16	2	GM		VT	C	3	16	GR	3 7/16	18 5/8	3/8		A	N	128638
									GR	2 3/4	18 5/8	C		A	N	
28 1/4	17 1/16	2	GM		VT	C	3	16	GR	3 1/2	18 5/8	3/8		A	N	128640
									GR	3 1/2	18 5/8	3/8		A	N	
28 1/4	17 1/16	2 5/8	GMC		VT	C	4	15	GR	3 1/2	18 5/8	C		A	N	124034
									GR	3 1/2	18 5/8	C		A	N	
28 1/4	17 1/16	2 5/8	GM	Reg. plant model	VT	C	4	12	GR	3 1/2	18 5/8	C		A	N	122548
									GR	3 1/2	18 5/8	C		A	N	
28 1/4	17 1/16	2 5/8	GM		VT	C	4	12	GR	2 3/4	18 5/8	C		A	N	128733
									GR	2 3/4	18 5/8	C		A	N	
28 1/4	17 1/16	2 5/8	GM		VT	C	4	12	GR	3 1/2	18 5/8	C		A	N	122603
									GR	2 3/4	18 5/8	C		A	N	
28 1/4	19	1 9/16	GM	VE CORE;3R-17 FPI	VE	C	3	17	GR	2 3/8	20 5/8	C		A	N	128187
									GR	2 3/8	20 5/8	C		A	N	
28 1/4	19	2 1/4	GM		VE	C	4	18	GR	2 3/4	20 7/8	C		A	N	128804
									GR	2 3/4	20 7/8	C		A	N	
28 1/4	19	2 1/4	GM	VE CORE;4R-12 FPI	VE	C	4	14	GR	3 1/2	20 7/8	3/8		A	N	128579
									GR	3 1/2	20 7/8	3/8		A	N	
28 1/4	19	2 3/4	GM		VE	C	5	14	GR	3 7/16	20 7/8	C		A	N	128806
									GR	3 7/16	20 7/8	C		A	N	
28 1/4	19 1/4	2	CHEV/GMC	CHEV TRK	VT	C	3	15	GR	3 1/2	20 7/8	3/8		A	N	124716
									GR	3 7/16	20 7/8	3/8		A	N	
28 1/4	19 1/4	2	GMC		VT	C	3	13	GR	2 3/4	20 7/8	C		A	N	124922
									GR	2 3/4	20 7/8	C		A	N	
28 1/4	19 1/4	2 5/8	GM	Reg. plant model	VT	C	4	15	GR	3 1/2	20 7/8	C		A	N	124672
									GR	3 1/2	20 7/8	C		A	N	
28 1/4	19 1/4	2 5/8	GM		VT	C	4	12	GR	2 3/4	20 7/8	C		A	N	128663
									GR	2 3/4	20 7/8	C		A	N	
28 1/4	19 7/16	1 9/16	GM		VE	C	3	16	GR	3 1/2	20 7/8	C		A	N	128805
									GR	3 1/2	20 7/8	C		A	N	
28 1/4	19 7/16	1 9/16	GM		VE	C	3	16	GR	2 3/4	20 7/8	C		A	N	128767
									GR	2 3/4	20 7/8	C		A	N	
28 1/4	19 7/16	2 1/4	GM		VE	C	4	14	GR	2 3/4	20 7/8	C		A	N	128803
									GR	2 3/4	20 7/8	C		A	N	
28 1/4	20 5/8	2 7/8	GMC		R	C	5	11	GR	3 1/2	20 7/8	C		A	C	281581
									GR	3 1/2	20 7/8	C		A	C	
28 1/4	21 1/4	3	JOHN DEERE	4020	X	C	4	10	GR	5 7/8	22	C		A	C	266193
									GR	3 3/8	22	C		A	C	
28 1/4	21 1/4	3	JOHN DEERE	4420	X	C	4	9	GR	5 7/8	22	C		A	C	289868
									GR	3 1/2	22	C		A	C	

Vista-Pro Automotive - Core Catalog
(Cores Sorted by Size)

Height	Width	Depth	Application	Description	Fin Type	Fin Matl	Rows	FPI	BH / TH Type	BH / TH Width	BH / TH Length	BH / TH OHF	BH / TH Bolts	BH / TH Shape	Hdr Support	Model #
28 1/4	21 15/16	3	JOHN DEERE	4420	T	C	4	9	GR GR	5 7/8 3 1/2	22 22	C C		A A	C C	278964
28 1/4	24	3	CHEV/GMC	C/FLO W/SIDE RAILS	B	C	4	7	GR GR	3 1/2 3 1/2	25 3/4 25 3/4	C C		A A	C C	229570
28 1/4	24	3 3/4	CATERPILLAR	12 GRADER HVY T/BTM HDRS BRASS FINNS FACE DIP T/HDR OFFSET FOR O/C	B	B	5	6	BH BH	8 1/2 6 5/8	33 24 1/8	C C	28 24	Z A	C C	274204
28 1/4	24 3/16	3	CHEV/GMC	C 40-80 C/FLO W/SIDE RAILS	T	C	4	10	GR GR	3 1/2 3 1/2	25 3/4 25 3/4	C C		A A	C C	223081
28 1/4	24 3/16	1 1/4	GMC TRUCK		VT	C	2	12	GR GR	3 1/2 3 1/2	25 3/4 25 3/4	C C		A A	N N	124596
28 1/4	24 3/16	2	GM		VT	C	3	12	GR GR	3 1/2 3 1/2	25 3/4 25 3/4	1/4 1/4		A A	N N	128750
28 1/4	24 3/16	2 5/8	GMC TRUCK	Reg. plant model	VT	C	4	13	GR GR	3 1/2 3 1/2	25 3/4 25 3/4	C C		A A	N N	122585
28 1/4	24 3/16	2 5/8	GM		VT	C	4	12	GR GR	3 1/2 3 1/2	25 3/4 25 3/4	C C		A A	N N	128751
28 1/4	24 3/8	2 15/16	CATERPILLAR	12 GRADER 6H9001 HVY T/BTM HDRS T OFFSET O/C 2 BTM CRNRS NOTCHED	Z	C	4	8	BH BH	8 1/2 6 5/8	33 24 1/8	2 1/8 C	28 24	Z F	C C	225248
28 1/4	24 3/8	4 7/16	CATERPILLAR	12 GRADER HVY T/BTM HDRS BRASS FINNS 2 BTM CRNRS NOTCHED T/ HDR OFFSET O/C	Z	B	6	8	BH BH	8 1/2 6 5/8	33 24 1/8	2 1/2 1 1/4	28 24	Z F	C C	225158
28 1/4	25 7/8	3 3/4	DETROIT DIESEL	6-71 DIESEL	T	C	5	10	GR GR	4 4	26 5/8 26 5/8	C C		A A	C C	279145
28 1/4	26	3 3/4	CATERPILLAR	941, 951B HVY T/BTM HDRS BRASS FINNS	B	B	5	6	BH BH	7 5/16 7 5/16	28 3/8 28 3/8	C C	30 30	A A	C C	229589
28 1/4	26 1/4	2 3/8	CHEV/GMC	TOP KICK C/FLO W/SIDE RAILS	R	C	4	10	GR GR	3 7/16 3 7/16	28 28	3/8 3/8		A A	C C	226349
28 1/4	26 3/8	2 5/8	GMC TRUCK	Reg. plant model	VT	C	4	12	GR GR	3 1/2 3 1/2	28 28	C C		A A	N N	128290
28 1/4	26 3/8	2 5/8	GM		VT	C	4	16	GR GR	3 1/2 3 1/2	28 28	C C		A A	N N	128526
28 1/4	27 1/2	1 3/4	CHEV/GMC	ASTRO 7500	R	C	3	10	BL BL	7 1/8 5 3/8	30 1/2 30 1/2	2 7/8 2	42 42	A A	C C	226350
28 1/4	27 1/2	1 3/4	FORD TRUCK	F600-900, F7000-8000	R	C	3	11	GR GR	4 1/4 2 7/8	27 7/8 27 7/8	1/4 C		A A	C C	226493
28 1/4	27 1/2	2	FORD TRUCK		VT	C	3	12	GR GR	4 1/4 2 7/8	27 7/8 27 7/8	1/4 C		A A	N N	128686
28 1/4	27 1/2	2 3/8	CHEV/GMC	ASTRO 7500	R	C	4	10	BL BL	7 1/8 5 3/8	30 1/2 30 1/2	C C	46 42	A A	C C	226351
28 1/4	27 1/2	2 3/8	FORD TRUCK	F600-900, F7000-8000	R	C	4	11	GR GR	4 1/4 2 7/8	27 7/8 27 7/8	3/16 3/16		A A	C C	226492
28 1/4	27 1/2	2 3/8	FORD TRUCK	F700 6" X 6" CRANK BOX	R	C	4	11	GR GR	4 1/4 2 7/8	27 7/8 27 7/8	3/16 3/16		A A	C C	226811
28 1/4	27 1/2	2 5/8	GM		VT	C	4	14	GR GR	3 1/2 3 1/2	28 13/16 28 13/16	C C		A A	N N	128531
28 1/4	29	3	CATERPILLAR	14 GRADER HVY T/BTM HDRS BRASS FINNS FACE DIPPED	B	B	4	8	BH BH	5 1/2 5 1/2	32 9/16 29 5/16	C C	30 26	F F	C C	229502
28 1/4	29	3	CATERPILLAR	14 GRADER HVY T/BTM HDRS BRASS FINNS	B	B	4	7	BH BH	5 7/16 5 7/16	32 9/16 29 5/16	C C	30 26	F F	C C	229590
28 1/4	29 3/8	2 3/16	CATERPILLAR	12 GRADER 9S4997, 7S1086 HVY T/BTM HDRS HVY STEEL FINNS 2 BTM CRNRS OF CORE NOTCHED	Z	S	3	9	BH BH	5 7/16 5 7/16	32 9/16 29 5/16	C C	30 26	F F	C C	225808
28 1/4	29 3/8	2 3/8	CATERPILLAR	920 LOADER HVY T/BTM HDRS	S	C	4	9	BH BH	5 1/2 5 1/2	32 3/4 29 3/8	C C	30 26	F F	C C	266187
28 1/4	29 3/8	2 15/16	CATERPILLAR	14 GRADER 4N8248 HVY T/BTM HDRS 2 BTM CRNRS OF CORE NOTCHED	Z	C	4	9	BH BH	5 7/16 5 7/16	32 9/16 29 3/8	C C	30 26	F F	C C	225119
28 1/4	29 3/8	2 15/16	CATERPILLAR	14 GRADER 4N8248 HVY T/BTM HDRS BRASS FINNS 2 BTM CRNRS NOTCHED	Z	B	4	9	BH BH	5 7/16 5 7/16	32 9/16 29 3/8	C C	30 26	F F	C C	225609
28 1/4	29 3/8	2 15/16	CATERPILLAR	14 GRADER 8N7857, 7S1085 HVY T/BTM HDRS HVY STEEL FINNS 2 BTM CRNRS OF CORE NOTCHED	Z	S	4	9	BH BH	5 7/16 5 7/16	32 9/16 29 5/16	C C	30 26	F F	C C	225835
28 1/4	24 1/4	2	GMC TRUCK		VT	C	3	13	GR GR	3 1/2 3 1/2	25 3/4 25 3/4	1/4 1/4		A A	N N	122523
28 1/4	16 15/16	2 1/4	CORE		VE	C	4	12	GR GR	3 7/16 3 7/16	18 5/8 18 5/8	5/8 5/8		A A	N N	128553
28 3/8	16 15/16	2 1/4	0	VE CORE	VE	C	4	16	GR GR	2 3/4 2 3/4	18 5/8 18 5/8	C C		A A	N N	122107

Vista-Pro Automotive - Core Catalog
(Cores Sorted by Size)

Height	Width	Depth	Application	Description	Fin Type	Fin Matl	Rows	FPI	BH / TH Type	BH / TH Width	BH / TH Length	BH / TH OHF	BH / TH Bolts	BH / TH Shape	Hdr Support	Model #
28 3/8	19 3/8	2 1/4	GM		VE	C	4	16	GR GR	3 1/2 3 1/2	20 7/8 20 7/8	C C		A A	N	122113
28 3/8	25 5/16	2 1/4	CHEV/GMC	C/FLO	T	C	3	10	GR GR	3 1/2 3 1/2	25 3/4 25 3/4	C C		A A	C	265206
28 3/8	25 5/16	3	CHEV/GMC	V-8 350-400 C/FLO	T	C	4	10	GR GR	3 1/2 3 1/2	25 3/4 25 3/4	C C		A A	C	265205
28 3/8	25 7/8	3	HALLIBURTON	3-53 DETROIT HVY BTM HDR	T	C	4	9	BL BH	6 1/2 6 1/2	28 1/2 28 1/2	C C	38 38	A A	C	272677
28 3/8	26 1/4	4 7/16	LIFT TRUCKS & LOADERS	MICHIGAN BRASS FINS	Z	B	6	8	GR GR	6 1/8 5 1/2	27 1/2 27 1/2	1/2 1/2		A A	C	282770
28 3/8	28 1/8	1 3/4	CHEV/GMC	ASTRO 7500	R	C	3	11	BL BL	7 1/8 5 1/4	30 1/2 30 1/2	2 1/4 1 3/8	46 42	A A	C	226352
28 3/8	28 1/8	2 1/4	CHEV/GMC	7500	T	C	3	9	BL BL	7 1/8 5 1/4	30 1/2 30 1/2	2 1/4 1 1/4	46 42	A A	C	263962
28 3/8	28 1/8	2 7/8	CHEV/GMC	9500	R	C	5	10	BL BL	7 1/8 5 1/4	30 1/2 30 1/2	C C	46 42	A A	C	226113
28 3/8	28 1/8	3	CHEV/GMC	7500 V6 DIESEL	T	C	4	9	BL BL	7 1/8 5 1/4	30 1/2 30 1/2	C C	46 42	A A	C	265508
28 1/2	13 3/4	2 3/8	JOY MANUFACTURING	185 CFM COMPRESSOR 519294-10	R	C	4	10	GR GR	3 3/8 3 3/8	14 3/8 14 3/8	C C		A A	C	226529
28 1/2	21 7/8	3 3/4	JOHN DEERE		X	C	5	9	GR GR	4 1/4 4 1/4	21 7/8 21 7/8	1/4 1/4		A A	C	281631
28 1/2	23 3/4	2 3/8	BROCKWAY		R	C	4	11	GR GR	6 7/8 3 5/8	24 1/4 24 1/4	7/8 7/8		A A	C	226302
28 1/2	23 3/4	2 3/8	MACK TRUCKS		R	C	4	11		6 7/8 3 5/8	24 1/4 24 1/4	1/4 1/4		0 0	C	226572
28 1/2	23 3/4	2 7/8	MACK TRUCKS	X-1631, X-1071-2	R	C	5	11	GR GR	6 7/8 3 5/8	24 1/4 24 1/4	3/8 3/8		A A	C	226574
28 1/2	25 5/8	2 3/8	NAVISTAR	LOADSTAR	R	C	4	9	GR GR	3 3	26 26	C C		A A	C	226177
28 1/2	25 7/8	2	INTERNATIONAL		VT	C	3	12	GR GR	3 3	26 1/4 26 1/4	9/16 9/16		A A	N	122657
28 1/2	25 7/8	2	INTERNATIONAL		VT	C	3	12	GR GR	3 3	26 26	C C		A A	N	124930
28 1/2	26 7/8	3	JOHN DEERE	6600	X	C	4	9	GR GR	4 1/4 4 1/4	28 1/4 28 1/4	C C		A A	C	260783
28 1/2	27 1/2	4 7/16	GROVE WORLDWIDE	CRANE BRASS FINS	Z	B	6	9		5 5	27 3/4 27 3/4	C C		0 0	C	286569
28 1/2	27 9/16	3	WAUKESHA	SCANIA HVY BTM HDR	T	C	4	8	BL BH	6 1/4 6 1/4	30 1/2 30 1/2	C C	42 42	A A	C	272534
28 1/2	28 1/8	2 15/16	OSHKOSH TRUCK	HVY T/BTM HDRS BRASS FINS	Z	B	4	11	BH BH	6 3/8 6 3/8	30 30	1 1/2 1 1/2	40 40	A A	C	286953
28 1/2	28 1/8	3	AJAX	DPC-80	X	C	4	7	BL BL	7 7	31 31	C C	36 36	A A	C	221211
28 1/2	28 1/8	3 3/4	AJAX		X	C	5	9	BL BL	6 7/8 6 7/8	31 1/8 31 1/8	1 7/16 1 7/16	30 30	A A	C	221210
28 9/16	28 11/16	3 3/4	GALION	GRADER HVY BTM HDR	T	C	5	8	BL BH	7 5/16 7 5/16	32 1/4 32 1/4	C C	40 40	A A	C	274736
28 9/16	28 11/16	4 1/2	GALION	ROLLER	T	C	6	9	BL BL	7 5/16 7 5/16	32 1/4 32 1/4	C C	40 40	A A	C	261516
28 9/16	28 3/4	4 7/16	GALION	BRASS FINS	Z	B	6	7	BL BL	7 5/16 7 5/16	32 1/2 32 1/2	1 1/2 1 1/2	40 40	B B	C	225310
28 5/8	21 7/8	3 7/16	JOHN DEERE	4250, 4450 RE21893	S	C	6	9	GR GR	4 3/16 4 3/16	21 7/8 21 7/8	3/16 3/16		A A	C	229022
28 5/8	21 7/8	3 15/16	JOHN DEERE	4440	S	C	7	9	GR GR	4 1/4 4 1/4	21 7/8 21 7/8	C C		A A	C	273805
28 5/8	26 1/4	2 7/8	NAVISTAR		R	C	5	8	GR GR	4 1/2 4 1/2	26 5/8 26 5/8	7/16 7/16		A A	C	226640
28 5/8	35 5/8	3 11/16	OSHKOSH TRUCK		Z	C	5	11	BL BL	7 3/8 7 3/8	38 5/8 38 5/8	C C	46 46	A A	C	282683
28 3/4	18	4 1/2	CASE/INTERNATIONAL	1150-D CRAWLER HVY T/BTM HDRS	T	C	6	8	BH BH	7 1/2 7 1/2	21 1/4 21 1/4	C C	30 30	A A	C	272790
28 3/4	21 7/8	3 3/4	JOHN DEERE	4460, 4480	X	C	5	10	GR GR	4 1/4 4 1/4	21 7/8 21 7/8	3/16 3/16		A A	C	286982

Vista-Pro Automotive - Core Catalog
(Cores Sorted by Size)

Height	Width	Depth	Application	Description	Fin Type	Fin Matl	Rows	FPI	BH / TH Type	BH / TH Width	BH / TH Length	BH / TH OHF	BH / TH Bolts	BH / TH Shape	Hdr Support	Model #
28 3/4	25	3 3/4	LIFT TRUCKS & LOADERS	CLARK SKIDDER HVY T/BTM HDRS BRASS FINS FACE DIPPED	B	B	5	6	BH BH	6 3/4 6 3/4	26 3/4 26 3/4	C C	32 32	A A	C C	272514
28 3/4	25 5/8	2 1/4	INT'L HARVESTER	U 372	X	C	3	8	GR GR	5 1/4 4	25 5/8 25 5/8	1 3/8 1 3/8		A A	C C	289273
28 3/4	26 1/4	2 3/8	FORD TRUCK	F700 BKT T/HDR RD INL 8 1/2" RT	R	C	4	11	BU GR	5 3	27 3/8 26 13/16	1 5/16 C		A A	C C	226494
28 3/4	26 7/16	2 1/4	FORD TRUCK	BKT T/HDR RD INL 8 1/2" RT	T	C	3	9	BU GR	5 3	27 5/16 26 13/16	C C		A A	C C	272776
28 7/8	23 5/8	3	MACK TRUCKS	B60	T	C	4	9	GR GR	6 7/8 3 5/8	24 1/4 24 1/4	1/4 1/4		A A	C C	262004
28 7/8	23 3/4	2 3/8	MACK TRUCKS	B60 X-973-C, C1	R	C	4	9	GR GR	6 7/8 3 5/8	24 1/4 24 1/4	1/4 1/4		A A	C C	226575
28 7/8	23 3/4	2 7/8	MACK TRUCKS		R	C	5	9	GR GR	6 7/8 3 5/8	24 1/4 24 1/4	1/4 1/4		A A	C C	226576
28 7/8	24 3/16	3	MACK TRUCKS		T	C	4	11	GR GR	6 7/8 3 5/8	24 1/4 24 1/4	3/16 3/16		A A	C C	275230
28 7/8	26 1/4	3 15/16	FIAT ALLIS	273317	S	C	7	10	GR GR	4 1/4 4 1/4	26 5/8 26 5/8	C C		A A	C C	229182
28 7/8	27 1/2	2	INTERNATIONAL		VT	C	3	12	GR GR	2 7/8 2 7/8	28 28	C C		A A	N N	122650
28 7/8	28 3/4	5 3/16	STEIGER TRACTOR	PANTHER BRASS FINS	Z	B	7	11	GR GR	5 5/8 5 5/8	29 3/4 29 3/4	C C		A A	C C	286649
28 7/8	29 1/4	5 1/4	STEIGER TRACTOR	PANTHER	T	C	7	9	GR GR	5 5/8 5 5/8	29 3/4 29 3/4	C C		A A	C C	265536
28 15/16	35	2 7/8	GILLIG BUS		R	C	5	11	BL BL	6 5/8 6 5/8	37 7/8 37 7/8	C C	46 46	A A	C C	226325
29	21 7/8	3	JOHN DEERE	4630	X	C	4	9	GR GR	6 3 7/8	21 7/8 21 7/8	2 3/4		A A	C C	289442
29	21 7/8	3 7/16	JOHN DEERE	4250	S	C	6	10	GR GR	5 4	22 1/4 22 1/4	C C		A A	C C	229023
29	21 7/8	3 3/4	JOHN DEERE	4630	X	C	5	11	GR GR	6 3 7/8	21 7/8 21 7/8	11/16 C		A A	C C	289876
29	21 15/16	3 3/4	JOHN DEERE	4630, 4640	T	C	5	10	GR GR	6 3 7/8	21 7/8 21 7/8	1/8 C		A A	C C	223210
29	22	3 3/4	JOHN DEERE	4630	B	C	5	7	GR GR	6 3 7/8	21 7/8 21 7/8	5/8 C		A A	C C	272756
29	23 5/8	2	GMC TRUCK		VT	C	3	12	BU BU	5 3/8 3 3/8	23 3/4 23 3/4	C C		A A	N N	122416
29	23 5/8	2	GM		VT	C	3	12	BU BU	4 3/8 3 3/8	23 3/4 23 3/4	C C		A A	N N	122432
29	23 5/8	2 5/8	GM		VT	C	4	12	BU BU	4 3/8 3 3/8	23 3/4 23 3/4	C C		A A	N N	122418
29	25 5/8	2 7/8	DRESSER INDUSTRIES	HOUGH PAYLOADER	S	C	5	9	GR GR	5 1/4 4 1/2	25 3/4 25 3/4	C C		A A	C C	266075
29	25 5/8	2 15/16	DETROIT DIESEL	6V-71 ENGINE	Z	C	4	10	CR CR	5 1/4 4 1/4	25 7/8 25 7/8	5/8 5/8		A A	C C	225413
29	25 5/8	3	DETROIT DIESEL	6V-71 ENGINE CRP/HDRS	X	C	4	8	CR CR	5 1/4 4 1/4	25 7/8 25 7/8	11/16 C		A A	C C	221821
29	25 5/8	3 11/16	DETROIT DIESEL	6V-71 ENGINE	Z	C	5	11	CR CR	5 1/4 4 1/4	25 7/8 25 7/8	1/2 3/8		A A	C C	225414
29	25 5/8	3 3/4	DETROIT DIESEL	6V-71 ENGINE	X	C	5	8	CR CR	5 1/4 4 1/4	25 7/8 25 7/8	1/2 C		A A	C C	221511
29	25 5/8	3 3/4	DETROIT DIESEL	6V-71 ENGINE	X	C	5	8	CR CR	7 1/4 4 1/4	17 3/4 25 7/8	3/8 5/16		A A	C C	281257
29	25 7/8	3	DETROIT DIESEL	6V-71 ENGINE	T	C	4	8	CR CR	5 1/4 4 1/4	26 26	11/16 C		A A	C C	223091
29	25 7/8	3 3/4	DETROIT DIESEL	6V-71 ENGINE	T	C	5	8	CR CR	5 1/4 4 1/4	25 7/8 25 7/8	9/16 C		A A	C C	223092
29	26 1/4	3 7/16	JOHN DEERE	4850	S	C	6	8	GR GR	5 4	26 3/4 26 3/4	C C		A A	C C	229176
29	27 1/2	1 1/4	FORD TRUCK		VT	C	2	16	GR GR	2 7/8 2 7/8	27 7/8 27 7/8	1 7/16 1 7/16		A A	N N	128137
29	27 1/2	2	FORD		VT	C	3	14	GR GR	2 7/8 2 7/8	27 7/8 27 7/8	1/2 1/2		A A	N N	128138

Vista-Pro Automotive - Core Catalog
(Cores Sorted by Size)

Height	Width	Depth	Application	Description	Fin Type	Fin Matl	Rows	FPI	BH / TH Type	BH / TH Width	BH / TH Length	BH / TH OHF	BH / TH Bolts	BH / TH Shape	Hdr Support	Model #
29	27 1/2	2 3/16	FORD TRUCK	FEED LOT	Z	C	3	7	GR GR	2 7/8 2 7/8	27 7/8 27 7/8	C C		A A	C	286926
29	27 1/2	2 5/8	FORD		VT	C	4	12	GR GR	2 7/8 2 7/8	27 7/8 27 7/8	C C		A A	N	128736
29	27 1/2	3 7/16	ORION BUS		R	C	6	10	BL BL	7 7	30 7/16 30 7/16	C C	42 42	A A	C	226886
29	32 1/16	4 1/2	EUCLID	HVY BTM HDR	T	C	6	7	BL BH	8 3/8 8 3/8	35 5/8 35 5/8	C C	46 46	B B	C	275314
29	34 5/16	2 1/4	MACK TRUCKS	R MODEL HVY BTM HDR	T	C	3	10	BL BH	6 6	37 1/8 37 1/8	C C	44 44	A A	C	265657
29	34 5/16	3	MACK TRUCKS	R MODEL HVY BTM HDR	T	C	4	10	BL BH	6 6	37 1/8 37 1/8	C C	44 44	A A	C	223226
29	34 5/16	4 1/2	V.M.E.	TS-24 HVY BTM HDR	T	C	6	7	BL BH	7 1/2 7 1/2	38 38	C C	48 48	A A	C	273289
29	34 3/8	1 3/4	MACK TRUCKS	E-1919 E-2416	R	C	3	11	BL BL	6 1/4 6 1/4	36 3/8 36 3/8	2 2	46 46	A A	C	226163
29	34 3/8	2 3/8	MACK TRUCKS	R MODEL E-2416-1	R	C	4	11	BL BL	6 1/4 6 1/4	36 3/8 36 3/8	C C	46 46	A A	C	226154
29	34 3/8	2 3/8	MACK TRUCKS	R MODEL 3MF-5224AP1, E-1610-1, 3MF-5296APZ HVY BTM HDR	R	C	4	8	BL BH	6 6	37 1/8 37 1/8	1 1/2 1 1/2	44 44	A A	C	226207
29	34 3/8	2 3/8	MACK TRUCKS	E-1440-4 HVY BTM HDR	R	C	4	11	BL BH	6 7/8 6 7/8	37 1/8 37 1/8	C C	44 44	A A	C	226209
29	34 3/8	2 3/8	MACK TRUCKS	R MODEL E-1758-2, X-2339-6	R	C	4	11	BL BL	6 7/8 6	37 1/8 37 1/8	C C	44 44	A A	C	226579
29	34 3/8	2 3/8	MACK TRUCKS	R MODEL ULTRA-FUSED CAN USE 226207	R	C	4	11	BL BL	6 6	37 1/8 37 1/8	1 1/2 1 1/2	44 44	A A	C	281938
29	34 3/8	2 7/8	MACK TRUCKS	E-2416-9	R	C	5	11	BL BL	6 1/4 6 1/4	36 3/8 36 3/8	C C	46 46	A A	C	226167
29	34 3/8	2 7/8	MACK TRUCKS	R MODEL E-1322 HVY BTM HDR	R	C	5	9	BL BH	6 6	37 1/8 37 1/8	C C	44 44	A A	C	226210
29	34 3/8	2 7/8	MACK TRUCKS	R MODEL E-1440-1, E1440-5 HVY BTM HDR	R	C	5	11	BL BH	6 7/8 6 7/8	37 1/8 37 1/8	C C	44 44	A A	C	226211
29	34 3/8	3 7/16	MACK TRUCKS	R MODEL E-1611 HVY BTM HDR	R	C	6	11	BL BH	6 6	37 1/8 37 1/8	C C	44 44	A A	C	226212
29	34 3/8	3 7/16	MACK TRUCKS	WESTERN HVY BTM HDR	R	C	6	11	BL BH	6 7/8 6 7/8	37 1/8 37 1/8	C C	44 44	A A	C	226580
29	34 3/8	3 7/16	MACK TRUCKS		R	C	6	11	BL BL	6 7/8 6	37 1/8 37 1/8	C C	44 44	A A	C	226581
29	34 1/2	2 1/4	MACK TRUCKS	E-2416-12	VH	C	3	16	BL BL	6 1/4 6 1/4	36 3/8 36 3/8	C C	46 46	A A	N	251141
29	34 1/2	2 1/4	MACK TRUCKS	R MODEL	VH	C	3	14	BL BL	6 6	37 1/8 37 1/8	1 1/2 1 1/2	44 44	A A	N	251110
29	34 1/2	3	MACK TRUCKS	E-2416-1	VH	C	4	14	BL BL	6 1/4 6 1/4	36 3/8 36 3/8	C C	46 46	A A	N	251128
29	34 1/2	1 1/2	MACK TRUCKS	SEE 251110	VTH	C	2	16	BL BL	6 6	37 1/8 37 1/8	1 1/2 1 1/2	44 44	A A	N	253110
29	34 1/2	1 1/2	MACK TRUCKS	SEE 251141	VTH	C	2	16	BL BL	6 1/4 6 1/4	36 3/8 36 3/8	C C	46 46	A A	N	253141
29	34 1/2	2 1/4	MACK TRUCKS	SEE 251141	VTH	C	3	16	BL BL	6 1/4 6 1/4	36 3/8 36 3/8	C C	46 46	A A	N	252141
29	34 1/2	2 1/4	MACK TRUCKS	SEE 251110	VTH	C	3	14	BL BL	6 6	37 1/8 37 1/8	1 1/2 1 1/2	44 44	A A	N	252110
29	34 1/2	2 1/4	MACK TRUCKS	SEE 251128	VTH	C	3	16	BL BL	6 1/4 6 1/4	36 3/8 36 3/8	C C	46 46	A A	N	252141
29	34 1/2	3	MACK TRUCKS	SEE 251128	VTH	C	4	14	BL BL	6 1/4 6 1/4	36 3/8 36 3/8	C C	46 46	A A	N	252128
29	34 3/4	2 1/4	MACK TRUCKS	ULTRA-FUSED E-2416-1 CAN USE 226154 OR 251141	VH	C	3	11	BL BL	6 1/4 6 1/4	36 3/8 36 3/8	C C	46 46	A A	N	284075
29	38 3/4	2 7/8	PETERBILT		R	C	5	11	BL BL	9 5/8 7	41 1/8 40 3/8	3 9/16 1 7/16	48 46	F F	C	226257
29	38 3/4	3 7/16	PETERBILT		R	C	6	11	BL BL	9 5/8 7	41 1/8 40 3/8	3 1/2 1 1/2	48 46	F F	C	226256
29	40 1/2	2 1/4	VOLVO/GM LO-FLOW VH	LOW FLOW DIMPLED TUBE	VH	C	3	15	BL BL	7 7	43 3/8 43 3/8	2 C	56 56	A A	N	251017

Vista-Pro Automotive - Core Catalog
(Cores Sorted by Size)

Height	Width	Depth	Application	Description	Fin Type	Fin Matl	Rows	FPI	BH / TH Type	BH / TH Width	BH / TH Length	BH / TH OHF	BH / TH Bolts	BH / TH Shape	Hdr Support	Model #
29	40 5/8	1 3/4	AUTOCAR		R	C	3	11	BL BL	7 7	43 3/8 43 3/8	C C	56 56	A A	CC	226208
29	40 5/8	2 3/8	VOLVO WHITEGMC	LOW FLOW DIMPLED TUBE	R	C	4	11	BL BL	7 7	43 3/8 43 3/8	C C	56 56	A A	CC	226007
29	40 5/8	2 7/8	FREIGHTLINER	LOW FLOW CAN USE 284395 DIMPLED TUBE	R	C	5	11	BL BL	7 7	43 3/8 43 3/8	C C	56 56	A A	CC	226002
29	40 5/8	2 7/8	VOLVO WHITEGMC	AERO	R	C	5	10	BL BL	7 7	43 3/8 43 3/8	2 1/2 2 1/2	56 56	A A	CC	226736
29 1/8	24 3/8	2 7/8	CONTINENTAL		S	C	5	8	GR GR	4 3/4 4 1/4	25 3/4 25 3/4	C C		0 0	C	266300
29 1/8	24 3/4	4 1/2	CAT-LeMASTER	D-4 REPL 4 CORES BRASS FINS	T	B	6	7	BH BH	6 1/2 6 1/2	25 25	C C	32 32	0 0	C	274170
29 1/8	24 3/4	4 1/2	CAT-LeMASTER	D-4H (IMRM) 2W6509, 8N7031 GROUPS REPL 5 CORES BRASS FINS	T	B	6	7	BH BH	6 1/2 6 1/2	25 25	C C	32 32	0 0	C	274222
29 1/8	25	4 7/16	CAT-LeMASTER	D-4 REPL 4 CORES BRASS FINS	Z	B	6	7	BH BH	6 1/2 6 1/2	25 25	C C	32 32	A A	C	284170
29 1/8	25	4 7/16	CAT-LeMASTER	D-4H (IMRM) 2W6509, 8N7031 GROUP REPL 5 CORES BRASS FINS	Z	B	6	7	BH BH	6 1/2 6 1/2	25 25	C C	32 32	A A	C	284222
29 1/8	25 5/16	3 3/4	JOHN DEERE	4440	T	C	5	9	GR GR	4 3/8 4 3/8	25 3/4 25 3/4	3/16 3/16		A A	C	223211
29 1/8	25 5/8	3 7/16	JOHN DEERE	4440	S	C	6	9	GR GR	4 3/8 4 3/8	25 3/4 25 3/4	1/8 1/8		A A	C	229177
29 1/8	25 5/8	3 3/4	JOHN DEERE	4440	X	C	5	9	GR GR	4 3/8 4 3/8	25 3/4 25 3/4	C C		A A	C	286966
29 1/8	27 1/2	2 3/8	FORD TRUCK	F700 6" X 6" CRANK BOX	R	C	4	11	GR GR	2 7/8 2 7/8	27 7/8 27 7/8	C C		A A	C	226831
29 1/8	28 3/4	4 7/16	CAT-LeMASTER	916, 928, IT28 1W9441 GROUP REPL 4 CORES BRASS FINS	Z	B	6	7	BH BH	6 1/2 6 1/2	29 29	C C	34 34	A A	C	284172
29 1/8	29 1/4	4 1/2	CAT-LeMASTER	916, 928, IT28 1W9441 GROUP REPL 4 CORES BRASS FINS	T	B	6	7	BH BH	6 1/2 6 1/2	29 29	C C	34 34	0 0	C	274172
29 1/8	31 7/8	5 3/16	CAT-LeMASTER	936E WO/AC 1W4553 GROUP REPL 5 CORES BRASS FINS	Z	B	7	7	BH BH	7 7	32 32	C C	38 38	0 0	C	284148
29 1/8	31 7/8	5 3/16	CAT-LeMASTER	936E W/AC 1W4555 GROUP REPL 8 CORES BRASS FINS	Z	B	7	7	BH BH	7 7	32 32	C C	38 38	0 0	C	284182
29 1/8	32 1/16	5 1/4	CAT-LeMASTER	936 WO/AC 1W4553 GROUP REPL 5 CORES BRASS FINS	T	B	7	7	BH BH	7 7	32 32	C C	38 38	0 0	C	274148
29 1/4	16 1/4	3 11/16	CATERPILLAR	943 LOADER 8N184 4 CRNRS OF CORE NOTCHED	Z	C	5	9	GR GR	6 1/2 6 1/2	16 5/8 16 5/8	C C		A A	C	225249
29 1/4	16 1/4	3 11/16	CATERPILLAR	943 LOADER 8N184 HVY STEEL FINS 4 CRNRS OF CORE NOTCHED	Z	S	5	9	GR GR	6 1/2 6 1/2	16 5/8 16 5/8	C C		A A	C	225883
29 1/4	16 1/4	4 7/16	CATERPILLAR	953 LOADER 8N185 BRASS FINS 4 CRNRS OF CORE NOTCHED	Z	B	6	9	GR GR	6 1/2 6 1/2	16 5/8 16 5/8	C C		A A	C	225250
29 1/4	16 1/4	4 7/16	CATERPILLAR	953 LOADER 8N185 HVY STEEL FINS 4 CRNRS OF CORE NOTCHED	Z	S	6	9	GR GR	6 1/2 6 1/2	16 5/8 16 5/8	C C		A A	C	225891
29 1/4	16 1/2	4 1/2	CATERPILLAR	953 LOADER 8N185 BRASS FINS FACE DIPPED 4 CRNRS NOTCHED	B	B	6	7	GR GR	6 1/2 6 1/2	16 5/8 16 5/8	C C		A A	C	229503
29 1/4	21 1/4	3 3/4	JOHN DEERE	4440	X	C	5	11	GR GR	6 3 7/8	21 7/8 21 7/8	C C		A A	C	221789
29 1/4	21 1/4	3 3/4	JOHN DEERE	3660	X	C	5	11	GR GR	6 3 7/8	21 7/8 21 7/8	1 3/4 C		A A	C	289527
29 1/4	21 7/8	3 7/16	JOHN DEERE	4630, 4030	S	C	6	9	GR GR	6 3 7/8	21 7/8 21 7/8	3/4 C		A A	C	266544
29 1/4	21 7/8	3 3/4	JOHN DEERE	4640	X	C	5	9	GR GR	6 3 7/8	21 7/8 21 7/8	3/4 C		A A	C	221515
29 1/4	21 7/8	3 3/4	JOHN DEERE	4450	X	C	5	11	GR GR	5 4	22 1/4 22 1/4	C C		A A	C	221795
29 1/4	21 15/16	3 3/4	JOHN DEERE	4460	T	C	5	10	GR GR	6 3 7/8	21 7/8 21 7/8	3/4 C		A A	C	223220
29 1/4	21 15/16	3 3/4	JOHN DEERE	4440, 4640	T	C	5	10	GR GR	6 3 7/8	21 7/8 21 7/8	C C		A A	C	223238
29 1/4	22	3 3/4	JOHN DEERE	4630	B	C	5	7	GR GR	6 3 7/8	21 7/8 21 7/8	3/4 C		A A	C	272755
29 1/4	25 5/16	3 3/4	JOHN DEERE	4640, 9940 RE21896, AN190887	T	C	5	10	GR GR	4 3/8 4 3/8	25 3/4 25 3/4	C C		A A	C	223224

Vista-Pro Automotive - Core Catalog
(Cores Sorted by Size)

Height	Width	Depth	Application	Description	Fin Type	Fin Matl	Rows	FPI	BH / TH Type	BH / TH Width	BH / TH Length	BH / TH OHF	BH / TH Bolts	BH / TH Shape	Hdr Support	Model #
29 1/4	27 1/2	2 7/8	DRESSER INDUSTRIES	520B LOADER 1279582-H91	S	C	5	7	GR GR	4 3/4 4 3/4	28 1/4 28 1/4	C C		A A	C C	229129
29 1/4	28 3/4	4 7/16	MILITARY	MILITARY CORE "LAV"	R	C	8	10	SQ SQ	5 1/4 5 1/4	30 1/8 30 1/8	C C		A A	C C	220035
29 1/4	29 1/4	4 1/2	P & H MANUFACTURING	HVY BTM HDR	T	C	6	10	BL BH	7 1/4 7 1/4	31 1/4 31 1/4	C C	42 42	A A	C C	272935
29 1/4	34 3/8	2 7/8	PETERBILT	LOW FLOW CAN USE 284751 DIMPLED TUBE	R	C	5	11	BL BL	6 5/8 6 5/8	37 1/2 37 1/2	C C	42 42	F F	C C	226006
29 1/4	34 1/2	3	PETERBILT	LOW FLOW CAN USE 284751 DIMPLED TUBE	VH	C	4	15	BL BL	6 5/8 6 5/8	37 1/2 37 1/2	C C	42 42	F F	N	251016
29 5/16	26 7/16	3	NAVISTAR	2010A	T	C	4	10	BL BL	10 6 1/4	28 3/4 28 3/4	1 1/8 1 1/8	42 38	A A	C	264039
29 5/16	29 3/8	4 7/16	CATERPILLAR	518 SKIDDER BRASS FINS	Z	B	6	9	GR GR	6 6	29 9/16 29 9/16	C C		A A	C	225355
29 5/16	29 3/8	5 3/16	CATERPILLAR	518 SKIDDER 8N4973 HVY STEEL FINS	Z	S	7	9	GR GR	6 6	29 9/16 29 9/16	C C		A A	C	225886
29 5/16	29 3/8	5 1/4	CATERPILLAR	518 SKIDDER	X	C	7	6	GR GR	6 6	29 9/16 29 9/16	C C		A A	C	266236
29 5/16	39 7/8	1 1/2	MACK TRUCKS	MODEL CH ULTRA-FUSED CAN USE 226104	VH	C	2	11	BL BL	6 1/4 6 1/4	42 42	C C	48 48	A A	N	284841
29 5/16	39 7/8	2 1/4	MACK TRUCKS	CH ULTRA-FUSED CAN USE 251126	VH	C	3	14	BL BL	6 1/4 6 1/4	42 42	C C	48 48	A A	N	284045
29 5/16	39 7/8	3	MACK TRUCKS	CH ULTRA-FUSED CAN USE 226219 OR 251130	VH	C	4	14	BL BL	6 1/4 6 1/4	42 42	C C	48 48	A A	N	284050
29 5/16	40	1 1/2	MACK TRUCKS	SEE 251126	VTH	C	2	16	BL BL	6 1/4 6 1/4	42 42	C C	48 48	A A	N	253126
29 5/16	40	2 1/4	MACK TRUCKS	SEE 251126	VTH	C	3	14	BL BL	6 1/4 6 1/4	42 42	C C	48 48	A A	N	252126
29 5/16	40	1 1/2	MACK TRUCKS	MODEL CH CAN USE 226104	VH	C	2	14	BL BL	6 1/4 6 1/4	42 42	C C	48 48	A A	N	251106
29 5/16	40	1 3/4	MACK TRUCKS	MODEL CH	R	C	3	11	BL BL	6 1/4 6 1/4	42 42	C C	48 48	A A	C	226104
29 5/16	40	2 1/4	MACK TRUCKS	CH CAN USE 226262	VH	C	3	14	BL BL	6 1/4 6 1/4	42 42	C C	48 48	A A	N	251126
29 5/16	40	2 3/8	MACK TRUCKS	CH MODEL X-3780-1	R	C	4	11	BL BL	6 1/4 6 1/4	42 42	C C	48 48	A A	C	226262
29 5/16	40	2 7/8	MACK TRUCKS	CH MODEL X-3780	R	C	5	11	BL BL	6 1/4 6 1/4	42 42	C C	48 48	A A	C	226219
29 5/16	40	3	MACK TRUCKS	CH	VH	C	4	14	BL BL	6 1/4 6 1/4	42 42	C C	48 48	A A	N	251130
29 3/8	21 7/8	3 7/16	JOHN DEERE	4630	S	C	6	7	GR GR	6 3 7/8	21 7/8 21 7/8	C C		A A	C	273806
29 3/8	26 1/4	2 3/8	NAVISTAR	2050	R	C	4	11	BL BL	6 1/4 6 1/4	28 3/4 28 3/4	1 1/8 1 1/8	38 38	A A	C	226642
29 3/8	26 1/4	2 3/8	NAVISTAR	F2010A	R	C	4	11	BL BL	10 6 1/4	28 3/4 28 3/4	1 1/8 1 1/8	42 38	A A	C	226643
29 3/8	26 1/4	2 7/8	NAVISTAR	2050	R	C	5	11	BL BL	6 1/4 6 1/4	28 3/4 28 3/4	1 1/8 1 1/8	38 38	A A	C	226178
29 3/8	26 1/4	2 7/8	NAVISTAR	2010A	R	C	5	10	BL BL	10 6 1/4	28 3/4 28 3/4	1 1/8 1 1/8	42 38	A A	C	226641
29 3/8	26 1/4	2 15/16	GRADALL	1100 CAT ENG	Z	C	4	9	GR GR	4 4	26 7/8 26 7/8	3/16 3/16		A A	C	289981
29 3/8	26 7/16	3	GRADALL	1100 CAT ENGINE	T	C	4	8	GR GR	4 4	26 7/8 26 7/8	3/16 3/16		A A	C	279250
29 3/8	26 7/16	3	NAVISTAR	F2010 HVY BTM HDR	T	C	4	9	BL BH	10 6 1/4	28 3/4 28 3/4	1 1/4 1 1/4	42 38	A A	C	223276
29 3/8	26 7/16	3	NAVISTAR		T	C	4	9	BL BL	6 1/4 6 1/4	28 3/4 28 3/4	1 1/4 1 1/4	38 38	A A	C	277959
29 3/8	27 1/2	3 7/16	GALION	GRADER D-138833	S	C	6	10	GR GR	4 1/4 4 1/4	28 1/4 28 1/4	C C		A A	C	229066
29 1/2	18 1/8	1 1/4	FORD		VT	C	2	12	GR GR	2 13/16 3 3/8	18 7/8 18 7/8	C C		A A	N	124673
29 1/2	18 1/8	2	FORD		VT	C	3	13	GR GR	2 13/16 3 3/8	18 7/8 18 7/8	5/16 5/16		A A	N	124674

Vista-Pro Automotive - Core Catalog
(Cores Sorted by Size)

Height	Width	Depth	Application	Description	Fin Type	Fin Matl	Rows	FPI	BH / TH Type	BH / TH Width	BH / TH Length	BH / TH OHF	BH / TH Bolts	BH / TH Shape	Hdr Support	Model #
29 1/2	21 15/16	3	FORD POWER PRODUCTS	POWER UNIT	T	C	4	10	GR	3 1/2	22 1/2	C		A	C	223161
									GR	3 1/2	22 1/2	C	A			
29 1/2	22 5/16	2 1/4	NAVISTAR	SEE 251132	VTH	C	3	15	BL	6 1/4	25 1/4	2 1/2	36	A	N	252132
									BL	6 1/4	25 1/4	2 1/2	36	A		
29 1/2	22 1/2	2 1/4	NAVISTAR	9700 SERIES 1652622-C94, 1651979-C93 CAN USE 226645	VH	C	3	15	BL	6 1/4	25 1/4	2 1/2	36	A	N	251132
									BL	6 1/4	25 1/4	2 1/2	36	A		
29 1/2	22 1/2	2 3/8	NAVISTAR	9700 SERIES 1652622-C94	R	C	4	11	BL	6 1/4	25 1/4	2 1/2	36	A	C	226645
									BL	6 1/4	25 1/4	2 1/2	36	A		
29 1/2	22 1/2	2 7/8	AERO	SPRAYER	S	C	5	9	GR	3 1/2	22 1/2	C		A	C	229005
									GR	3 1/2	22 1/2	C	A			
29 1/2	24 3/16	3 3/4	FIAT ALLIS	HD-7G HVY BTM HDR	T	C	5	8	BL	6 7/8	26	1 3/8	42	A	C	265431
									BH	6 7/8	26	1 3/8	42	A		
29 1/2	28	4 1/2	INT'L HARVESTER	530 LOADER BRASS FINS FACE DIPPED	B	B	6	7	GR	5 3/4	28 3/4	C		A	C	272696
									GR	5 3/4	28 3/4	C	A			
29 1/2	28 1/8	4 7/16	LIFT TRUCKS & LOADERS	HOUGH H-65 BRASS FINS	Z	B	6	7	GR	5 7/8	28 3/4	C		A	C	289975
									GR	5 7/8	28 3/4	C	A			
29 1/2	28 1/8	4 1/2	LIFT TRUCKS & LOADERS	HOUGH H65	T	C	6	8	GR	5 7/8	28 3/4	C		A	C	279705
									GR	5 7/8	28 3/4	C	A			
29 1/2	28 3/4	4 7/16	INT'L HARVESTER	530 LOADER BRASS FINS	Z	B	6	9	GR	5 3/4	28 5/8	C		A	C	285112
									GR	5 3/4	28 5/8	C	A			
29 1/2	29 3/8	5 3/16	LIFT TRUCKS & LOADERS	MICHIGAN BRASS FINS	Z	B	7	9	GR	6 1/8	30 3/4	C		A	C	286952
									GR	6 1/8	30 3/4	C	A			
29 1/2	24 3/4	4 3/8	METRO BUS		T	C	6	10	BL	7 5/8	27	C	38	A	C	289979
									BL	7 5/8	27	C	38	A		
29 9/16	27 1/2	3 15/16	KOHLER ENGINES & GEN	A-254428	S	C	7	9	GR	4 3/4	28 1/4	C		A	C	229125
									GR	4 3/4	28 1/4	C	A			
29 5/8	25	2 15/16	JOHN DEERE	678 LOADER	Z	C	4	9	GR	4 3/8	25 7/8	3/16		A	C	282716
									GR	4 3/8	25 7/8	3/16	A			
29 5/8	25 5/16	3	JOHN DEERE	670A AT71241	T	C	4	9	GR	4 3/8	25 7/8	1/8		A	C	272516
									GR	4 3/8	25 7/8	1/8	A			
29 5/8	31 7/8	4 7/16	DRESSER INDUSTRIES	TD-15 630717-C1 BRASS FINS	Z	B	6	8	BL	9 3/8	34 1/4	C	38	A	C	225183
									GR	5 3/4	32 1/4	C	A			
29 5/8	31 7/8	4 7/16	DRESSER INDUSTRIES	TD-15 630717-C1 HVY STEEL FINS	Z	S	6	8	BL	9 3/8	34 1/4	C	38	A	C	225939
									GR	5 3/4	32 1/4	C	A			
29 5/8	32	5 1/4	DRESSER INDUSTRIES	TD-15B HVY T/HDR BRASS FINS FACE DIPPED	B	B	7	6	BH	9 3/8	34 1/4	2	38	A	C	275226
									GR	5 3/4	32 1/4	1/2	A			
29 5/8	32 1/16	4 1/2	DRESSER INDUSTRIES	TD-15B HVY T/BTM HDRS BRASS FINS FACE DIPPED	T	B	6	7	BH	9 3/8	34 1/4	2	38	A	C	272697
									GR	5 3/4	32 1/4	1/2	A			
29 5/8	33 1/8	2 3/16	CATERPILLAR	14E GRADER 8S7794 2 BTM CRNRS NOTCHED	Z	C	3	9	BL	5 7/16	36 7/16	C	34	F	C	225253
									BL	5 7/16	33 1/4	C	30	A		
29 5/8	33 1/8	2 15/16	CATERPILLAR	14E GRADER 8S7795 HVY T/BTM HDRS BRASS FINS 2 BTM CRNRS OF CORE NOTCHED	Z	B	4	9	BH	5 7/16	36 7/16	C	34	F	F	225189
									BH	5 7/16	33 1/4	C	30	A		
29 5/8	33 1/8	2 15/16	CATERPILLAR	14E GRADER 8S7795 HVY T/BTM HDRS HVY STEEL FINS 2 BTM CRNRS OF CORE NOTCHED	Z	S	4	9	BH	5 7/16	36 7/16	C	34	F	F	225850
									BH	5 7/16	33 1/4	C	30	A		
29 5/8	33 3/16	3	CATERPILLAR	14E GRADER HVY T/BTM HDRS 2 BTM CRNRS OF CORE NOTCHED	T	C	4	9	BH	5 7/16	36 7/16	C	34	F	C	277129
									BH	5 7/16	33 1/4	C	30	A		
29 5/8	30 5/8	6 1/8	HD CORE		X	B	8	8	BH	8 3/8	33 1/4	C	50	A	F	272564
									BH	8 3/8	33 1/4	C	50	A		
29 3/4	23 5/8	2	GM		VT	C	3	12	BU	4 3/8	23 3/4	C		A	N	124722
									GR	3 3/8	23 3/4	C	A			
29 3/4	23 5/8	2 5/8	GM		VT	C	4	12	BU	4 3/8	23 3/4	C		A	N	124723
									GR	3 3/8	23 3/4	C	A			
29 3/4	25 5/8	2 1/4	NAVISTAR		VE	C	4	15	GR	3 1/8	26 5/8	C		A	N	128200
									GR	3 1/8	26 5/8	C	A			
29 3/4	25 5/8	1 3/4	NAVISTAR		R	C	3	8	GR	3 1/8	26 1/4	C		A	C	226179
									GR	3 1/8	26 1/4	C	A			
29 3/4	25 5/8	2 3/8	NAVISTAR	DT466 4900	R	C	4	11	GR	3 1/8	26 5/8	C		A	C	226803
									GR	3 1/8	26 5/8	C	A			
29 3/4	25 5/8	2 3/8	NAVISTAR	WITH PTO	R	C	4	11	GR	3 1/8	26 5/8	C		A	C	226862
									GR	3 1/8	26 5/8	C	A			

Vista-Pro Automotive - Core Catalog
(Cores Sorted by Size)

Height	Width	Depth	Application	Description	Fin Type	Fin Matl	Rows	FPI	BH / TH Type	BH / TH Width	BH / TH Length	BH / TH OHF	BH / TH Bolts	BH / TH Shape	Hdr Support	Model #
29 3/4	25 13/16	2	INTERNATIONAL	6 x 6 CRANK BOX	VT	C	3	14	GR GR	2 7/8 2 7/8	26 3/8 26 3/8	C C		A A	N	128003
29 3/4	25 7/8	1 1/4	INTERNATIONAL		VT	C	2	14	GR GR	3 3	26 13/16 26 13/16	C C		A A	N	128713
29 3/4	25 7/8	2	INTERNATIONAL		VT	C	3	12	GR GR	3 1/16 3 1/16	26 26	C C		A A	N	122670
29 3/4	25 7/8	2	INTERNATIONAL		VT	C	3	14	GR GR	3 1/8 3 1/8	26 5/8 26 5/8	C C		A A	N	128854
29 3/4	25 7/8	2	INTERNATIONAL		VT	C	3	12	GR GR	3 1/8 3 1/8	26 1/4 26 1/4	C C		A A	N	124986
29 3/4	25 7/8	2 5/8	INTERNATIONAL		VT	C	4	12	GR GR	3 1/8 3 1/8	26 1/4 26 1/4	C C		A A	N	124984
29 3/4	28 11/16	3 3/4	LORAIN SHOVEL		T	C	5	9	BL BL	7 1/2 7 1/2	30 3/4 30 3/4	1 5/16 1 5/16	42 42	A A	C	272926
29 3/4	29 13/16	3 3/4	LIFT TRUCKS & LOADERS	MICHIGAN HVY T/BTM HDRS BRASS FINS	T	B	5	9	BH BH	7 7	32 32	1 1/2 1 1/2	44 44	A A	C	265610
29 3/4	30	3 11/16	LIFT TRUCKS & LOADERS	CLARK HVY BTM HDR	Z	C	5	10	BL BH	7 7	32 32	1 1/2 1 1/2	44 44	A A	C	286702
29 3/4	30 3/8	3 3/4	JOHN DEERE	860	T	C	5	10	GR GR	4 1/4 4 1/4	31 31	C C		A A	C	278968
29 3/4	30 5/8	3 3/4	JOHN DEERE	740, 750	X	C	5	6	GR GR	4 1/4 4 1/4	31 31	C C		A A	C	266304
29 3/4	30 5/8	3 3/4	JOHN DEERE	860 SCRAPER	X	C	5	9	GR GR	4 1/4 4 1/4	31 31	C C		A A	C	289651
29 3/4	25 7/8	2	NAVISTAR		VT	C	3	14	GR GR	2 7/8 2 7/8	26 1/4 26 1/4	C C		A A	N	129021
29 3/4	25 7/8	2	NAVISTAR		VT	C	3	14	GR GR	2 7/8 2 7/8	26 1/4 26 1/4	C C		A A	N	129027
29 7/8	26 1/4	3 7/16	JOHN DEERE	4840	S	C	6	11	GR GR	6 3/8 4	26 3/4 26 3/4	C C		A A	C	266540
29 7/8	26 1/4	3 3/4	JOHN DEERE	4840	X	C	5	10	GR GR	6 3/8 4	26 3/4 26 3/4	1 1/4 C		A A	C	221790
29 7/8	30	4 7/16	MINNEAPOLIS MOLINE	BRASS FINS	Z	B	6	8	BL BL	7 1/2 7 1/2	32 1/8 32 1/8	C C	28 28	A A	C	288892
29 15/16	26 7/8	2 1/4	MINNEAPOLIS MOLINE	HEB, HUA, KES	X	C	3	7	BL BL	7 7	30 30	C C	30 30	A A	C	270441
30	16 7/8	3 7/16	NOVA BUS	G1050366 DIMPLED TUBES DIMPLED TUBE	S	C	6	11	BL BL	6 1/4 6 1/4	18 1/2 18 1/2	C C	28 28	A A	C	229205
30	26 1/4	2 7/8	BLUE BIRD BUS		R	C	5	11	GR GR	8 1/4 4	26 7/8 26 7/8	3/8 3/8		A A	C	226296
30	26 7/16	4 1/2	CATERPILLAR	955 HVY T/BTM HDRS BRASS FINS 4 CRNRS OF CORE NOTCHED	T	B	6	9	BH BH	6 1/2 6 1/2	26 3/4 26 3/4	C C	26 26	F F	C	260720
30	26 7/8	3	WAUKESHA	GK-140	X	C	4	7	BL BL	7 1/4 7 1/4	30 30	C C	36 36	H H	C	274842
30	26 7/8	3 11/16	WAUKESHA	GK-140	Z	C	5	8	BL BL	7 1/4 7 1/4	30 30	1 1/4 1 1/4	36 36	H H	C	282090
30	26 7/8	4 7/16	CATERPILLAR	955 3S9738 HVY T/BTM HDRS BRASS FINS 4 CRNRS OF CORE NOTCHED	Z	B	6	9	BH BH	6 1/2 6 1/2	26 3/4 26 3/4	C C	26 26	F F	F	225125
30	26 7/8	4 7/16	CATERPILLAR	955 3S9738 HVY T/BTM HDRS HVY STEEL FINS 4 CRNRS OF CORE NOTCHED	Z	S	6	9	BH BH	6 1/2 6 1/2	26 3/4 26 3/4	C C	26 26	F F	F	225836
30	27	3 3/4	WAUKESHA	GK-140, MD1554	T	C	5	7	BL BL	7 1/4 7 1/4	30 30	C C	36 36	H H	C	270504
30	27 1/2	4 7/16	PETTIBONE	BRASS FINS	Z	B	6	8	GR GR	5 5	28 3/4 28 3/4	C C		A A	C	286955
30	28 1/8	3 7/16	PETERBILT	348 CONVENTIONAL	R	C	6	11	BL BL	9 5/8 7	30 3/4 30	3 5/16 1 5/16	38 36	DD F	C	226705
30	28 1/8	3 3/4	PETERBILT	348 CONVENTIONAL	X	C	5	11	BL BL	9 5/8 7	30 3/4 30	3 5/16 1 5/16	38 36	DD F	C	286375
30	28 1/8	4 7/16	PETERBILT	CEMENT MIXER BRASS FINS	Z	B	6	9	BL BL	9 5/8 7	30 3/4 30	3 3/8 C	38 36	H F	C	286996
30	28 1/8	4 1/2	FIAT ALLIS	750 LOADER	T	C	6	8	GR GR	4 7/8 4 7/8	29 3/4 29 3/4	1/8 1/8		A A	C	278640

Vista-Pro Automotive - Core Catalog
(Cores Sorted by Size)

Height	Width	Depth	Application	Description	Fin Type	Fin Matl	Rows	FPI	BH / TH Type	BH / TH Width	BH / TH Length	BH / TH OHF	BH / TH Bolts	BH / TH Shape	Hdr Support	Model #
30	28 11/16	3 3/4	CHEV/GMC	PD4104	T	C	5	9	BL BL	6 1/4 6 1/4	30 3/4 30 3/4	C C	36 36	F F	C	270355
30	28 3/4	2 7/8	CHEV/GMC	PD4104	R	C	5	11	BL BL	6 1/4 6 1/4	30 3/4 30 3/4	1 3/4 1 3/4	36 36	F F	C	226358
30	28 3/4	4 7/16	FIAT ALLIS	645 LOADER BRASS FINS	Z	B	6	8	BL BL	7 1/4 7 1/4	31 1/4 31 1/4	C C	40 40	A A	C	286518
30	29	3 3/4	FIAT ALLIS	HD-11 HVY BTM HDR BRASS FINS FACE DIPPED	B	B	5	6	BL BH	6 5/8 6 5/8	32 1/4 32 1/4	C C	44 44	A A	C	274513
30	29	4 1/2	FIAT ALLIS	750 LOADER HVY T/BTM HDRS BRASS FINS FACE DIPPED	B	B	6	6	BH BH	7 1/4 7 1/4	31 1/4 31 1/4	C C	40 40	A A	C	272456
30	29 1/4	3	DETROIT DIESEL	6V-71 ENGINE	T	C	4	10	GR GR	4 7/8 4 7/8	29 3/4 29 3/4	3/16 3/16		A A	C	223093
30	29 1/4	3 3/4	CHEV/GMC	PD4104	T	C	5	8	BL BL	6 1/4 6 1/4	30 3/4 30 3/4	C C	36 36	F F	C	260355
30	29 1/4	5 1/4	JOHN DEERE	FORKLIFT	T	C	7	9	GR GR	5 3/4 5 3/4	29 1/2 29 1/2	C C		A A	C	223615
30	29 3/8	3 11/16	FIAT ALLIS	HD-11	Z	C	5	8	BL BL	6 5/8 6 5/8	32 1/4 32 1/4	1 5/8 1 5/8	44 44	A A	C	225499
30	29 3/8	3 3/4	CHEV/GMC	4104 BUS HVY T/BTM HDRS	X	C	5	9	BH BH	6 1/4 6 1/4	30 3/4 30 3/4	C C	36 36	F F	C	266051
30	29 3/8	5 3/16	JOHN DEERE	644B SCRAPER BRASS FINS	Z	B	7	9	GR GR	5 3/4 5 3/4	29 1/2 29 1/2	C C		A A	C	225617
30	29 11/16	2 5/8	CHEV/GMC		VT	C	4	14	GR GR	3 3/8 3 3/8	31 7/8 31 7/8	C C		A A	N	128888
30	29 13/16	3 3/4	JOHN DEERE	740 AT78645	T	C	5	6	GR GR	4 1/2 4 1/2	31 1/4 31 1/4	C C		A A	C	265499
30	30	3 11/16	CUMMINS ENGINE	GE DIESEL HVY T/BTM HDRS	Z	C	5	11	BH BH	6 1/4 6 1/4	32 7/8 32 7/8	1 1/2 1 1/2	32 32	A A	C	225448
30	30 5/8	4 7/16	CATERPILLAR	966 3S4515 HVY T/BTM HDRS BRASS FINS	Z	B	6	9	BH BH	6 5/8 6 5/8	36 1/4 31 1/4	C C	32 28	A A	C	225023
30	31 1/2	4 1/2	FIAT ALLIS	HD-11 HVY T/BTM HDRS BRASS FINS FACE DIPPED	B	B	6	7	BH BH	7 5/8 7 5/8	34 7/8 34 7/8	C C	44 44	A A	C	278639
30	31 1/2	5 1/4	FIAT ALLIS	HD-11 HVY T/BTM HDRS BRASS FINS	T	B	7	7	BH BH	7 5/8 7 5/8	34 7/8 34 7/8	C C	44 44	A A	C	264117
30	32 1/2	2 3/8	AUTOCAR	TEMPLATE #2	R	C	4	11	BL BL	10 6 5/8	36 3/4 36 1/8	2 1/2 2 1/2	48 46	I C	C	226267
30	32 1/2	2 3/8	AUTOCAR	TEMPLATE #2	R	C	4	11	BL BL	10 6 5/8	36 3/4 36 1/8	1 1/4 1 1/4	48 46	I C	C	226271
30	32 1/2	2 7/8	AUTOCAR	TEMPLATE #2	R	C	5	10	BL BL	10 6 5/8	36 3/4 36 1/8	2 1/2 2 1/2	48 46	I C	C	226102
30	32 1/2	2 7/8	AUTOCAR	TEMPLATE #2	R	C	5	11	BL BL	10 6 5/8	36 3/4 36 1/8	1 1/2 1 1/2	48 46	I C	C	226272
30	35 7/16	4 1/2	CATERPILLAR	D-6 POWER SHIFT HVY T/BTM HDRS BRASS FINS 4 CRNRS OF CORE NOTCHED	T	B	6	9	BH BH	6 9/16 6 9/16	36 1/4 36 1/4	C C	32 32	F F	C	263381
30	35 1/2	3	CATERPILLAR	D-6C HVY T/BTM HDRS BRASS FINS FACE DIPPED 4 CRNRS OF CORE NOTCHED	B	B	4	7	BH BH	6 9/16 6 9/16	36 1/4 36 1/4	C C	32 32	F F	C	275214
30	35 1/2	4 1/2	CATERPILLAR	D-6C 9M6037 HVY T/BTM HDRS BRASS FINS FACE DIPPED 4 CRNRS OF CORE NOTCHED	B	B	6	7	BH BH	6 9/16 6 9/16	36 1/4 36 1/4	C C	32 32	F F	C	229559
30	35 1/2	4 1/2	CATERPILLAR	D-6C 9M6037 HVY T/BTM HDRS BRASS FINS 4 CRNRS OF CORE NOTCHED	B	B	6	7	BH BH	6 9/16 6 9/16	36 1/4 36 1/4	C C	32 32	F F	C	229591
30	35 5/8	2 15/16	CATERPILLAR	D-6C 7S1852 HVY T/BTM HDRS BRASS FINS 4 CRNRS OF CORE NOTCHED	Z	B	4	8	BH BH	6 9/16 6 9/16	36 1/4 36 1/4	C C	32 32	F F	C	225048
30	35 5/8	3	CATERPILLAR	D-6C HVY T/BTM HDRS 4 CRNRS OF CORE NOTCHED	X	C	4	7	BH BH	6 9/16 6 9/16	36 1/4 36 1/4	C C	32 32	F F	C	266160
30	35 5/8	4 7/16	CATERPILLAR	D-6C 9M6032 HVY T/BTM HDRS BRASS FINS 4 CRNRS OF CORE NOTCHED	Z	B	6	9	BH BH	6 9/16 6 9/16	36 1/4 36 1/4	C C	32 32	F F	C	225061
30	35 5/8	4 7/16	CATERPILLAR	D-6C 7S2530 HVY T/BTM HDRS HVY STEEL FINS 4 CRNRS OF CORE NOTCHED	Z	S	6	9	BH BH	6 9/16 6 9/16	36 1/4 36 1/4	C C	32 32	F F	C	225809

Vista-Pro Automotive - Core Catalog
(Cores Sorted by Size)

Height	Width	Depth	Application	Description	Fin Type	Fin Matl	Rows	FPI	BH / TH Type	BH / TH Width	BH / TH Length	BH / TH OHF	BH / TH Bolts	BH / TH Shape	Hdr Support	Model #
30	43 1/8	2 3/8	CHEV/GMC	GENERAL 15601472 LOW FLOW CAN USE 284772 DIMPLED TUBE	R	C	4	11	BL BL	7 7	45 1/4 45 1/4	1 5/8 1 5/8	60 60	B B	CC	226001
30	43 1/8	2 7/8	CHEV/GMC	GENERAL	R	C	5	11	BL BL	7 7	45 1/4 45 1/4	1 5/8 1 5/8	60 60	B B	CC	226114
30 1/8	16 7/8	4 7/16	VOSS BUS	DIMPLED TUBE	R	C	8	11	BL BL	7 3/4 7 3/4	18 1/2 18 1/2	C C	30 30	A A	C	226867
30 1/8	25 5/8	2 3/8	MACK TRUCKS	BABY 8	R	C	4	11	GR GR	3 7/16 3 7/16	26 1/8 26 1/8	C C		A A	C	226164
30 1/8	26 1/4	3 7/16	JOHN DEERE	4640	S	C	6	9	GR GR	6 7/16 4	26 3/4 26 3/4	1 1/2 C		A A	C	229024
30 1/8	26 1/4	3 3/4	JOHN DEERE	4840	X	C	5	9	GR GR	6 1/2 4	26 3/4 26 3/4	C C		A A	C	221861
30 1/8	26 1/4	3 3/4	JOHN DEERE	4640	X	C	5	9	GR GR	6 1/2 4	26 3/4 26 3/4	1 1/2 1/4		A A	C	265914
30 1/8	26 1/4	3 15/16	JOHN DEERE	4840	S	C	7	9	GR FR	6 7/16 4	26 3/4 26 3/4	C C		A A	C	229009
30 1/8	17 1/2	4 7/16	HD CORE		R	C	8	11	BL BL	7 7/8 7 7/8	18 5/8 18 5/8	C C	30 30	A A	C	229143
30 1/4	11 1/2	3 3/4	LIFT TRUCKS & LOADERS	BOBCAT LOADER	B	C	5	7	GR GR	4 5/16 4 5/16	12 1/16 12 1/16	C C		A A	C	229519
30 1/4	25 7/8	2	FORD		VT	C	3	12	GR GR	3 3	26 13/16 26 13/16	C C		A A	N	128748
30 1/4	25 7/8	2 5/8	FORD		VT	C	4	12	GR GR	3 3	26 13/16 26 13/16	C C		A A	N	128749
30 1/4	26 1/4	1 3/4	FORD TRUCK	L800, L8000 C/FLO	R	C	3	11	GR GR	3 3	26 13/16 26 13/16	C C		A A	C	226152
30 1/4	26 1/4	2 3/8	FORD TRUCK	L800, LN8000 C/FLO	R	C	4	11	GR GR	3 3	26 13/16 26 13/16	C C		A A	C	226153
30 1/4	26 1/4	2 15/16	FORD TRUCK	L800 FEED LOT C/FLO	Z	C	4	7	GR FR	3 3	26 13/16 26 13/16	C C		A A	C	286732
30 1/4	26 3/8	1 1/4	FORD TRUCK		VT	C	2	12	GR GR	3 3	26 13/16 26 13/16	9/16 9/16		A A	N	124885
30 1/4	26 3/8	2	FORD TRUCK		VT	C	3	12	GR GR	3 3	26 13/16 26 13/16	C C		A A	N	124886
30 1/4	26 3/8	2 5/8	FORD TRUCK		VT	C	4	12	GR GR	3 3	26 13/16 26 13/16	C C		A A	N	124887
30 1/4	26 7/16	2 1/4	FORD TRUCK	LN8000 C/FLO	T	C	3	9	GR GR	3 3	26 13/16 26 13/16	C C		A A	C	223168
30 1/4	26 1/2	2 1/4	FORD TRUCK	FEED LOT C/FLO	B	C	3	7	GR GR	3 3	26 13/16 26 13/16	C C		A A	C	272765
30 1/4	26 1/2	3	FORD TRUCK	L800, L8000 FEEDLOT C/FLO	B	C	4	7	GR GR	3 3	26 7/8 26 7/8	C C		0 0	C	229515
30 1/4	28 3/4	3 11/16	CATERPILLAR	916 LOADER 9Y8310	Z	C	5	9	GR GR	6 6	29 1/2 29 1/2	C C		A A	C	225291
30 1/4	29 1/4	2 1/4	NAVISTAR	TEMPLATE #15	T	C	3	10	BL BL	10 1/4 6 7/8	31 1/4 31 1/4	2 1/4 2 1/4	54 40	A A	C	277429
30 1/4	29 3/8	1 3/4	NAVISTAR	TEMPLATE #14A	R	C	3	11	BL BL	10 1/4 6 7/8	31 1/4 31 1/4	1 5/8 1 5/8	54 40	A A	C	226651
30 1/4	29 3/8	1 3/4	NAVISTAR	TEMPLATE #18A	R	C	3	11	BL BL	10 1/4 6 7/8	31 1/4 31 1/4	1 5/8 1 5/8	54 40	A A	C	226889
30 1/4	29 3/8	2 3/8	NAVISTAR	5000 PAYSTAR TEMPLATE #14	R	C	4	11	BL BL	10 1/4 6 7/8	31 1/4 31 1/4	1 5/8 1 5/8	54 40	A A	C	226652
30 1/4	29 3/8	2 3/8	NAVISTAR	5000 PAYSTAR TEMPLATE #15	R	C	4	11	BL BL	10 1/4 6 7/8	31 1/4 31 1/4	1 5/8 1 5/8	54 40	A A	C	226653
30 1/4	29 3/8	2 7/8	NAVISTAR	5070 PAYSTAR TEMPLATE #12	R	C	5	11	BL BL	10 1/4 6 7/8	31 1/4 31 1/4	2 C	54 40	A A	C	226648
30 1/4	29 3/8	2 7/8	NAVISTAR	5070 PAYSTAR TEMPLATE #14A	R	C	5	11	BL BL	10 1/4 6 7/8	31 1/4 31 1/4	2 C	54 40	A A	C	226649
30 1/4	29 3/8	2 7/8	NAVISTAR	5000 PAYSTAR TEMPLATE #14	R	C	5	11	BL BL	10 1/4 6 7/8	31 1/4 31 1/4	1 7/8 1 7/8	54 40	A A	C	226650
30 1/4	29 3/8	3 7/16	NAVISTAR	5070 PAYSTAR TEMPLATE #14	R	C	6	11	BL BL	10 1/4 6 7/8	31 1/4 31 1/4	1 5/8 1 5/8	54 40	A A	C	226181
30 1/4	29 3/8	3 3/4	TEREX	LIFT	X	C	5	8	GR GR	4 7/8 4 7/8	29 3/4 29 3/4	3/8 3/8		A A	C	289563

Vista-Pro Automotive - Core Catalog
(Cores Sorted by Size)

Height	Width	Depth	Application	Description	Fin Type	Fin Matl	Rows	FPI	BH / TH Type	BH / TH Width	BH / TH Length	BH / TH OHF	BH / TH Bolts	BH / TH Shape	Hdr Support	Model #
30 1/4	30	4 7/16	CASE/INTERNATIONAL	W-36 BRASS FINS	Z	B	6	9	GR GR	5 5	31 31	C C		A A	C	225339
30 1/4	30 5/8	3 15/16	KOHLER ENGINES & GEN	180 KW A-273927	S	C	7	10	GR GR	4 7/16 4 7/16	31 1/16 31 1/16	C C		A A	C	229126
30 3/8	22 1/2	2 7/8	MACK TRUCKS	RENAULT	R	C	5	11	GR GR	3 3/8 3 3/8	22 1/2 22 1/2	C C		A A	C	226582
30 3/8	34 3/8	2 3/8	MACK TRUCKS		R	C	4	11	BL BL	6 1/4 6 1/4	36 3/8 36 3/8	C C	46 46	A A	C	226584
30 3/8	34 3/8	2 7/8	MACK TRUCKS		R	C	5	11	BL BL	6 1/4 6 1/4	36 3/8 36 3/8	C C	46 46	A A	C	226135
30 3/8	34 1/2	2 1/4	MACK TRUCKS	DM RD X-3571, X-3321 CAN USE 226584	VH	C	3	14	BL BL	6 1/4 6 1/4	36 3/8 36 3/8	C C	46 46	A A	N	251003
30 3/8	34 1/2	3	MACK TRUCKS	DM, RD CAN USE 284718 OR 226135	VH	C	4	16	BL BL	6 1/4 6 1/4	36 3/8 36 3/8	C C	46 46	A A	N	251136
30 3/8	34 1/2	1 1/2	MACK TRUCKS	SEE 251003	VTH	C	2	16	BL BL	6 1/4 6 1/4	36 3/8 36 3/8	C C	46 46	A A	N	253003
30 3/8	34 1/2	2 1/4	MACK TRUCKS	SEE 251003	VTH	C	3	14	BL BL	6 1/4 6 1/4	36 3/8 36 3/8	C C	46 46	A A	N	252003
30 3/8	34 1/2	2 1/4	MACK TRUCKS	SEE 251136	VTH	C	3	14	BL BL	6 1/4 6 1/4	36 3/8 36 3/8	C C	46 46	A A	N	253136
30 3/8	34 1/2	3	MACK TRUCKS	SEE 251136	VTH	C	4	16	BL BL	6 1/4 6 1/4	36 3/8 36 3/8	C C	46 46	A A	N	252136
30 3/8	34 3/4	2 1/4	MACK TRUCKS	DM, RD ULTRA FUSED CAN USE 226584 OR 251003	VH	C	3	14	BL BL	6 1/4 6 1/4	36 3/8 36 3/8	C C	46 46	A A	N	284020
30 3/8	34 3/4	3	MACK TRUCKS	ULTRA-FUSED J-3571-03 CAN USE 226135 OR 251136	VH	C	4	16	BL BL	6 1/4 6 1/4	36 3/8 36 3/8	C C	46 46	A A	N	284718
30 3/8	36 9/16	3	CATERPILLAR	D-7 BRASS FINS	T	B	4	7	GR GR	4 3/4 3 9/16	37 3/8 37 3/8	1/4 1/4		A A	CC	271936
30 1/2	16 1/4	4 7/16	CASE/INTERNATIONAL	850-D LOADER R-49826 BRASS FINS	Z	B	6	9	BL BL	7 1/2 7 1/2	18 3/8 18 3/8	C C	30 30	A A	C	225005
30 1/2	16 5/16	4 1/2	JOHN DEERE		T	C	6	9	BL BL	7 1/2 7 1/2	19 1/4 19 1/4	C C	30 30	A A	C	272903
30 1/2	16 15/16	1	GM		VE	C	2	16	GR GR	2 3/8 2 3/8	18 5/8 18 5/8	3/8 3/8		A A	N	128577
30 1/2	16 15/16	1 9/16	GM	VE CORE;3R-14 FPI	VE	C	3	14	GR GR	2 3/8 2 3/8	18 5/8 18 5/8	C C		A A	N	128772
30 1/2	16 15/16	1 9/16	GM		VE	C	3	14	GR GR	2 3/4 2 3/4	18 5/8 18 5/8	3/8 3/8		A A	N	128296
30 1/2	17 1/16	1 1/4	BUICK		VT	C	2	14	GR GR	2 3/4 2 1/16	18 5/8 18 5/8	3/8 C		A A	N	124828
30 1/2	17 1/16	2	CADILLAC		VT	C	3	14	GR GR	2 3/4 2 3/4	18 5/8 18 5/8	C C		A A	N	124829
30 1/2	17 1/16	2 5/8	GM		VT	C	4	12	GR GR	2 7/8 2 7/8	18 5/8 18 5/8	C C		A A	N	128741
30 1/2	17 3/8	2 1/4	GM		VE	C	4	16	GR GR	3 1/2 3 1/2	18 5/8 18 5/8	5/8 5/8		A A	N	128763
30 1/2	24	4 1/2	CATERPILLAR	944D, 950 HVY T/BTM HDRS BRASS FINS FACE DIPPED	B	B	6	7	BH BH	6 1/2 6 1/2	27 3/4 24 7/16	C C	26 24	A A	C	276855
30 1/2	24 3/16	4 1/2	CATERPILLAR	950 HVY T/BTM HDRS BRASS FINS TOP HDR OFFSET FOR O/C	T	B	6	9	BH BH	6 1/2 6 1/2	27 3/4 24 7/16	C C	26 24	A A	C	264131
30 1/2	24 3/8	4 7/16	CATERPILLAR	950 3S2320 HVY T/BTM HDRS BRASS FINS 3 CRNRS OF CORE NOTCHED	Z	B	6	9	BH BH	6 1/2 6 1/2	27 3/4 24 3/8	C C	26 24	F F	C	225358
30 1/2	24 3/8	4 7/16	CATERPILLAR	944D, 950 3S2320 HVY T/BTM HDRS HVY STEEL FINS	Z	S	6	7	BH BH	6 1/2 6 1/2	27 3/4 27 3/4	C C	26 26	F F	F	225847
30 1/2	26 1/4	2 3/8	INT'L HARVESTER	5088 146571-C2	S	C	4	9	GR GR	4 1/4 4 1/4	26 5/8 26 5/8	11/16 11/16		A A	C	229107
30 1/2	26 1/4	2 7/8	INT'L HARVESTER	5288, 146573-C1	S	C	5	9	GR GR	4 1/4 4 1/4	26 5/8 26 5/8	1/8 1/8		A A	C	229108
30 1/2	26 1/4	3 7/16	INT'L HARVESTER	5488 146572-C2	S	C	6	10	GR GR	4 1/4 4 1/4	26 5/8 26 5/8	11/16 11/16		A A	C	229109
30 1/2	26 1/4	3 3/4	DETROIT DIESEL	6V-71 DIESEL	X	C	5	8	BL BL	7 1/2 7 1/2	31 3/8 31 3/8	1 3/16 1 3/16	32 32	LL LL	C	280180

Vista-Pro Automotive - Core Catalog
(Cores Sorted by Size)

Height	Width	Depth	Application	Description	Fin Type	Fin Matl	Rows	FPI	BH / TH Type	BH / TH Width	BH / TH Length	BH / TH OHF	BH / TH Bolts	BH / TH Shape	Hdr Support	Model #
30 1/2	26 1/4	3 15/16	INT'L HARVESTER	5488 146508-C1	S	C	7	10	GR GR	4 1/4 4 1/4	26 5/8 26 5/8	C C		A A	C C	229110
30 1/2	26 1/4	3 15/16	INT'L HARVESTER	5488 146508-C1	S	C	7	10	GR GR	4 1/4 4 1/4	26 5/8 26 5/8	C C		A A	C C	229110
30 1/2	26 1/4	3 15/16	INT'L HARVESTER	5488 146508-C1	S	C	7	10	GR GR	4 1/4 4 1/4	26 5/8 26 5/8	C C		A A	C C	229110
30 1/2	26 1/4	4 7/16	CATERPILLAR	966 7S2244 HVY T/BTM HDRS BRASS FINS	Z	B	6	7	BH BH	6 1/2 6 1/2	27 3/4 27 3/4	C C	26 26	F F	C C	225359
30 1/2	26 1/4	4 7/16	CATERPILLAR	966 7S2244 HVY T/BTM HDRS HVY STEEL FINS	Z	S	6	7	BH BH	6 1/2 6 1/2	27 3/4 27 3/4	C C	26 26	F F	C C	225888
30 1/2	26 7/16	3 3/4	DETROIT DIESEL	6V-71 DIESEL	T	C	5	7	BL BL	7 1/2 7 1/2	31 3/8 31 3/8	1 3/16 1 3/16	32 32	B B	C C	270200
30 1/2	26 7/16	4 1/2	CATERPILLAR	966 HVY T/BTM HDRS BRASS FINS	T	B	6	9	BH BH	6 1/2 6 1/2	27 3/4 27 3/4	C C	26 26	A A	C C	264064
30 1/2	26 1/2	4 1/2	CATERPILLAR	966 HVY T/BTM HDRS BRASS FINS FACE DIPPED	B	B	6	6	BH BH	6 1/2 6 1/2	27 3/4 27 3/4	C C	26 26	A A	C C	229560
30 1/2	26 1/2	4 1/2	CATERPILLAR	966 HVY T/BTM HDRS BRASS FINS	B	B	6	6	BH BH	6 1/2 6 1/2	27 3/4 27 3/4	C C	26 26	A A	C C	229593
30 1/2	28 3/4	4 7/16	FORD TRACTOR	TR85 COMBINE 616992 BRASS FINS	Z	B	6	6	GR GR	5 7/8 5 7/8	29 1/2 29 1/2	C C		A A	C C	225478
30 1/2	33 1/8	3 3/4	FLXIBLE BUS	6V-92 HVY T/BTM HDRS	X	C	5	10	BH BH	7 7	36 5/16 36 5/16	1 3/4 1 3/4	46 46	A A	C C	221900
30 1/2	36 7/8	3 15/16	FLXIBLE BUS	DETROIT DIESEL 97-8550-00151	S	C	7	11	BL BL	7 7	38 7/8 38 7/8	C C	48 48	A A	C C	229206
30 9/16	33 1/8	3 11/16	CATERPILLAR	D342 HVY T/BTM HDRS	Z	C	5	10	BH BH	7 3/4 6 5/16	36 1/2 33 1/2	1 11/16 1	32 32	Q F	C C	225360
30 5/8	24 3/8	2 7/8	OTTAWA TRUCK	YARD MULE HVY BTM HDR	R	C	5	9	BL BH	6 1/2 6 1/2	27 27	C C	34 34	A A	C C	226843
30 7/8	26 7/8	4 7/16	CAT-LeMASTER	D-5H 9Y8531, 8N9536 GROUPS REPL 6 CORES BRASS FINS	Z	B	6	7	BH BH	6 1/2 6 1/2	27 27	C C	34 34	0 0	C C	284210
31	11 1/8	1 9/16	JEEP		VE	C	3	14	GR GR	2 3/8 2 3/8	11 5/16 11 5/16	C C		A A	N N	128727
31	12 1/8	2	NAVISTAR		VT	C	3	15	GR GR	3 3	26 1/4 26 1/4	C C		A A	N N	124033
31	12 1/8	2 5/8	NAVISTAR		VT	C	4	14	GR GR	3 1/8 3 1/8	26 5/8 26 5/8	C C		A A	N N	124041
31	12 5/8	2	INTERNATIONAL		VT	C	3	16	GR GR	3 1/8 3 1/8	26 5/8 26 5/8	C C		A A	N N	128890
31	25 5/16	2 5/8	CHEV/GMC		VT	C	4	12	GR GR	3 1/2 3 1/2	25 3/4 25 3/4	C C		A A	N N	128863
31	25 5/8	1 3/4	NAVISTAR	2050	R	C	3	8	GR GR	3 1/8 3 1/8	26 1/4 26 1/4	C C		A A	C C	226184
31	25 5/8	1 3/4	NAVISTAR	2050 6 X 6 1/2" CRANK BOX	R	C	3	8	GR GR	3 1/8 3 1/8	26 1/4 26 1/4	C C		A A	C C	226847
31	25 5/8	2 3/8	NAVISTAR	AT190	R	C	4	11	GR GR	3 1/8 3 1/8	26 1/4 26 1/4	C C		A A	C C	226185
31	25 5/8	2 3/8	NAVISTAR	DT466 1900	R	C	4	11	GR GR	3 1/8 3 1/8	26 5/8 26 5/8	C C		A A	C C	226802
31	25 5/8	2 3/8	NAVISTAR	6" X 6 1/2" CRANK BOX	R	C	4	11	GR GR	3 1/8 3 1/8	26 1/4 26 1/4	C C		A A	C C	226819
31	25 5/8	2 3/8	NAVISTAR	WITH PTO	R	C	4	11	GR GR	3 1/8 3 1/8	26 5/8 26 5/8	C C		A A	C C	226861
31	25 5/8	2 15/16	NAVISTAR	FEED LOT	Z	C	4	9	GR GR	3 1/8 3 1/8	26 1/4 26 1/4	C C		A A	C C	281589
31	25 7/8	1 1/4	INTERNATIONAL		VT	C	2	14	GR GR	3 3	26 13/16 26 13/16	C C		A A	N N	128712
31	25 7/8	2	INTERNATIONAL		VT	C	3	12	GR GR	2 7/8 2 7/8	26 1/4 26 1/4	C C		A A	N N	124051
31	25 7/8	2	INTERNATIONAL		VT	C	3	16	GR GR	3 1/8 3 1/8	26 1/4 26 1/4	5/8 5/8		A A	N N	128709
31	25 7/8	2	INTERNATIONAL		VT	C	3	12	GR GR	3 3	26 26	C C		A A	N N	124970
31	25 7/8	2	NAVISTAR		VT	C	3	12	GR GR	3 1/8 3 1/8	26 5/8 26 5/8	3/8 3/8		A A	N N	124061

Vista-Pro Automotive - Core Catalog
(Cores Sorted by Size)

Height	Width	Depth	Application	Description	Fin Type	Fin Matl	Rows	FPI	BH / TH Type	BH / TH Width	BH / TH Length	BH / TH OHF	BH / TH Bolts	BH / TH Shape	Hdr Support	Model #
31	25 7/8	2	NAVISTAR		VT	C	3	16	GR GR	3 3	26 26	C C		A A	N	122700
31	25 7/8	2	NAVISTAR		VT	C	3	16	GR GR	3 1/8 3 1/8	26 1/4 26 1/4	C C		A A	N	122711
31	25 7/8	2 5/8	NAVISTAR	CRANK BOX	VT	C	4	12	GR GR	3 1/8 3 1/8	26 1/4 26 1/4	C C		A A	N	124831
31	25 7/8	2 5/8	NAVISTAR		VT	C	4	14	GR GR	3 1/8 3 1/8	26 1/4 26 1/4	C C		A A	N	128507
31	26	1 9/16	NAVISTAR		VE	C	3	14	GR GR	3 1/8 3 1/8	26 5/8 26 5/8	3/8 3/8		A A	N	128865
31	26 3/8	2	INTERNATIONAL		VT	C	3	12	GR GR	3 1/8 3 1/8	26 5/8 26 5/8	3/8 3/8		A A	N	122672
31	26 3/8	2 5/8	NAVISTAR		VT	C	4	12	GR GR	3 1/8 3 1/8	26 5/8 26 5/8	C C		A A	N	122218
31	27 9/16	3	JOHN DEERE	770A GRADER AT64734	T	C	4	9	GR GR	4 1/4 4 1/4	28 1/4 28 1/4	1/8 1/8		A A	C	272506
31	35	3	WESTERN STAR	LOW FLOW NEW VH CONSTRUCTION DIMPLED TUBE	VH	C	4	15	BL BL	6 11/16 6 11/16	38 38	C C	46 46	A A	N	251005
31	35 5/8	2 7/8	WESTERN STAR	LOW FLOW DIMPLED TUBE	R	C	5	11	BL BL	6 5/8 6 5/8	37 7/8 37 7/8	C C	46 46	A A	C	226042
31 1/16	11 7/8	2 3/8	INTERNATIONAL	CAC MOUNTS UNDER HDR 3/8" OFFSET SIDE	R	C	4	11	GR GR	3 3	26 26	C C		A A	C	226849
31 1/16	17 1/2	4 7/16	CASE/INTERNATIONAL	1150-E, 1155-E R-52599E BRASS FINS NOTCH T/HDR 1 CRNR	Z	B	6	9	BL BL	7 1/2 7 1/2	20 20	C C	32 32	A A	C	225006
31 1/8	27 1/2	2 7/8	CASE/INTERNATIONAL	821, 821 LOADER A-189363, A-189024	S	C	5	7	GR GR	4 3/4 4 3/4	28 1/4 28 1/4	C C		A A	C	229153
31 1/8	27 1/2	3 7/16	CASE/INTERNATIONAL	721 A-189365	S	C	6	6	GR GR	4 3/4 4 3/4	28 1/4 28 1/4	3/8 3/8		A A	C	229170
31 1/8	27 1/2	4 7/16	CASE/INTERNATIONAL	821 LOADER A-190623 BRASS FINS	Z	B	6	7	GR GR	4 3/4 4 3/4	28 1/4 28 1/4	C C		A A	C	225007
31 1/8	30	3 3/4	FORD TRACTOR	850, 875, 900	X	C	5	9	GR GR	4 7/8 4 7/8	31 1/2 31 1/2	C C		A A	C	221509
31 1/8	37 1/2	4 7/16	F.W.D.	HVY BTM HDR BRASS FINS	Z	B	6	11	BL BH	9 1/4 9 1/4	39 5/8 39 5/8	1 1/2 1 1/2	52 52	A A	C	289125
31 1/8	38 1/8	4 5/8	WAGONER TRACTOR	WC-17 COMPACTOR HVY T/BTM HDRS	X	C	6	11	BH BH	8 7/8 8 7/8	39 3/8 39 3/8	1 3/4 1 3/4	52 52	A A	C	266203
31 3/16	36	3	CATERPILLAR	D-7 HVY T/BTM HDRS BRASS FINS FACE DIPPED	B	B	4	7	BH BH	6 5/16 6 5/16	38 1/2 38 1/2	C C	34 34	F F	C	274598
31 5/16	12 1/4	2 1/4	NAVISTAR		VTH	C	3	14	GR GR	2 7/8 2 7/8	26 1/4 26 1/4	C C		A A	N	254033
31 7/16	40	3 11/16	OSHKOSH TRUCK	ADVANCE MIXER X-3600-3	Z	C	5	9	BL BL	7 3/4 7 3/4	42 1/2 42 1/2	C C	54 54	A A	C	225309
31 1/2	28 1/8	2 7/8	NAVISTAR		R	C	5	11	BL BL	6 1/8 6 1/8	31 1/2 31 1/2	1 1/8 1 1/8	42 42	A A	C	226654
31 1/2	31 1/2	4 1/2	KOMATSU	HVY T/BTM HDRS	T	C	6	7	BH BH	6 7/8 6 7/8	35 3/4 35 3/4	C C	36 36	A A	C	265664
31 1/2	31 1/2	4 1/2	KOMATSU	HVY T/BTM HDRS BRASS FINS FACE DIPPED	B	B	6	7	BH BH	6 7/8 6 7/8	35 3/4 35 3/4	C C	36 36	A A	C	272521
31 5/8	21 7/8	3 15/16	GILLIG BUS	OE 82-17447-009	S	C	7	10	BL BL	7 5/8 7 5/8	24 24	C C	34 34	A A	C	223630
31 5/8	28 3/4	1 3/4	WESTERN STAR	TEMPLATE #20	R	C	3	10	BL BL	10 3/8 6	31 1/4 31 1/4	3 1/8 C	54 42	B B	C	226781
31 5/8	29 3/8	1 3/4	WESTERN STAR	TEMPLATE #20	R	C	3	10	BL SQ	10 3/8 6	31 1/4 31 1/4	3 1/8 C	54 40	B A	C	226780
31 5/8	29 3/8	2 3/8	WESTERN STAR	TEMPLATE #20	R	C	4	10	BL BL	10 3/8 6	31 1/4 31 1/4	2 3/4 C	54 42	B B	C	226782
31 5/8	29 3/8	2 7/8	WESTERN STAR	TEMPLATE #20	R	C	5	10	BL BL	10 3/8 6	31 1/4 31 1/4	3 1 3/4	54 42	B B	C	226784
31 5/8	31 1/4	2 3/8	MACK TRUCKS	B73, B75 E-1109-3, X-832-C HVY BTM HDR	R	C	4	9	BL BH	5 3/8 6 3/4	36 3/8 34 1/8	1 7/16 1 3/8	30 30	C B	C	226586
31 11/16	28	3 3/4	CATERPILLAR	D-7 HVY T/BTM HDRS BRASS FINS	B	B	5	6	BH BH	6 3/8 6 3/8	29 7/8 29 7/8	C C	28 28	W W	C	229594
31 3/4	27 9/16	3	NAVISTAR	2000 FLEETSTAR TEMPLATE #18	T	C	4	10	BL BL	10 1/8 6	29 1/2 29 1/2	1 1/4 1 1/4	42 40	A A	C	223294

Vista-Pro Automotive - Core Catalog
(Cores Sorted by Size)

Height	Width	Depth	Application	Description	Fin Type	Fin Matl	Rows	FPI	BH / TH Type	BH / TH Width	BH / TH Length	BH / TH OHF	BH / TH Bolts	BH / TH Shape	Hdr Support	Model #
31 3/4	28 11/16	3 3/4	MASSEY-FERGUSON	1800 INL T/HDR	T	C	5	7	BL BL	10 1/4 6	31 1/2 31 1/2	1 3/16 1 3/16	46 42	A A	C	277411
31 3/4	28 3/4	3 11/16	MASSEY-FERGUSON	MODEL 1805 BRASS FINS	Z	B	5	11	BL BL	6 7/16 6 1/8	31 1/2 31 1/2	1 1/4 C	42 42	A A	C	281987
31 3/4	28 3/4	3 3/4	MASSEY-FERGUSON	1800 W/CAT ENGINE HVY BTM HDR	X	C	5	10	BL BH	10 1/4 6 1/8	31 1/2 31 1/2	1 1/4 1 1/4	46 42	A A	C	265972
31 3/4	30 5/8	3 15/16	CASE/INTERNATIONAL	9250, 9260	S	C	7	9	GR GR	5 13/16 5 13/16	31 7/16 31 7/16	C C		A A	C	229171
31 3/4	38 3/4	3 15/16	GILLIG BUS	DIMPLED TUBE	R	C	7	9	BL BL	6 9/16 6 9/16	41 3/4 41 3/4	C C	50 50	A A	C	226869
31 3/4	39 15/16	4 1/2	KENWORTH	C500 HVY BTM HDR	T	C	6	10	BL BH	7 7/8 7 1/4	43 1/2 43 1/2	C C	40 40	A A	C	265572
31 3/4	40	3 7/16	KENWORTH	C500	R	C	6	11	BL BL	7 7/8 7 1/4	43 1/2 43 1/2	C C	40 40	A A	C	226537
31 3/4	40	4 7/16	KENWORTH	C500	R	C	8	10	BL BL	7 7/8 7 1/4	43 1/2 43 1/2	C C	40 40	A A	C	226536
31 3/4	40 7/16	1 1/2	VOLVO/GM	SEE 251122	VTH	C	2	16	BL BL	7 7	43 3/8 43 3/8	2 13/16 2 13/16	56 56	A A	N	253122
31 3/4	40 7/16	1 1/2	VOLVO/GM	SEE 251008 DIMPLED TUBE	VTH	C	2	16	BL BL	7 7	43 3/8 43 3/8	2 13/16 2 13/16	56 56	A A	N	253008
31 3/4	40 7/16	2 1/4	VOLVO/GM	SEE 251122	VTH	C	3	14	BL BL	7 7	43 3/8 43 3/8	2 13/16 2 13/16	56 56	A A	N	252122
31 3/4	40 1/2	2 1/4	VOLVO WHITEGMC	AERO ULTRA-FUSED LOW FLOW CAN USE 251008 DIMPLED TUBE	VH	C	3	15	BL BL	7 7	43 3/8 43 3/8	2 13/16 2 13/16	56 56	A A	N	284749
31 3/4	40 1/2	2 1/4	VOLVO/GM	AERO CAN USE 226107	VH	C	3	14	BL BL	7 7	43 3/8 43 3/8	2 13/16 2 13/16	56 56	A A	N	251122
31 3/4	40 1/2	2 1/4	VOLVO/GM	LOW FLOW CAN USE 284749 DIMPLED TUBE	VH	C	3	15	BL BL	7 7	43 3/8 43 3/8	2 13/16 2 13/16	56 56	A A	N	251008
31 3/4	40 5/8	2 3/8	VOLVO TRUCK	DIMPLED TUBE	R	C	4	11	BL BL	7 7	43 3/8 43 3/8	2 13/16 2 13/16	56 56	0 A	CC	225964
31 3/4	40 5/8	2 3/8	VOLVO WHITEGMC	LOW FLOW CAN USE 284749 DIMPLED TUBE	R	C	4	11	BL BL	7 7	43 3/8 43 3/8	2 13/16 2 13/16	56 56	A A	CC	226010
31 3/4	40 5/8	2 3/8	VOLVO WHITEGMC	AERO	R	C	4	11	BL BL	7 7	43 3/8 43 3/8	C C	56 56	A A	CC	226107
31 3/4	41 1/4	3 7/16	KENWORTH	K94	R	C	6	11	BL BL	7 5/16 7 5/16	43 1/2 43 1/2	C C	52 52	A A	CC	226539
31 3/4	40 7/16	2 1/4	VOLVO		VTH	C	3	14	BL BL	7 7	43 3/8 43 3/8	2 13/16 2 13/16	56 56	A A	N	252008
31 7/8	27 9/16	3	NAVISTAR		T	C	4	10	BL BL	10 1/8 6 1/8	29 1/2 29 1/2	1 1/8 1 1/8	42 40	A A	C	265577
31 7/8	28 3/4	1 3/4	THOMAS BUS		R	C	3	11	BL BL	6 7/8 6 7/8	31 1/4 31 1/4	2 2	40 40	A A	C	226598
31 7/8	31 7/8	3 7/16	CUMMINS/DETROIT		R	C	6	11	BL BL	7 1/8 7 1/8	34 34	C C	40 40	A A	C	226853
31 7/8	43 7/8	3 3/4	DETROIT DIESEL	12V-71 HVY T/BTM HDRS	T	C	5	10	BH BH	8 8	46 3/4 46 3/4	C C	54 54	A A	CC	223095
32	25 5/16	2 5/8	CHEV/GMC		VT	C	4	13	GR GR	3 1/2 3 1/2	25 3/4 25 3/4	C C		A A	N	122673
32	26 1/4	2 7/8	DIAMOND REO		R	C	5	11	GR GR	8 1/4 4	26 7/8 26 7/8	3/8 3/8		A A	C	226418
32	26 1/4	3 7/16	OTTAWA TRUCK		R	C	6	11	GR GR	8 1/4 4	26 7/8 26 7/8	3/8 C		A A	C	226704
32	26 1/4	4 7/16	OSHKOSH TRUCK	712 BRASS FINS	Z	B	6	9	BL BL	7 1/4 7 1/4	28 7/8 28 7/8	1 3/8 1 3/8	30 30	EE EE	C	287588
32	27	4 1/2	CASE/INTERNATIONAL	1450 CRAWLER HVY T/BTM HDRS BRASS FINS FACE DIPPED	B	B	6	7	BH BH	7 1/8 7 1/8	28 7/8 28 7/8	C C	38 38	A A	C	278795
32	27 1/2	4 7/16	CASE/INTERNATIONAL	1450 CRAWLER HVY T/BTM HDRS BRASS FINS	Z	B	6	7	BH BH	7 1/8 7 1/8	28 7/8 28 7/8	C C	38 38	A A	C	225341
32	30	4 7/16	SEAGRAVE	FIRE ENGINE HVY BTM HDR BRASS FINS	Z	B	6	11	BL BH	7 15/16 7 15/16	32 3/4 32 3/4	C C	44 44	A A	C	282757
32	31 1/4	2 7/8	JOY MANUFACTURING	519294-0011 HVY BTM HDR	R	C	5	10	BL BH	9 3/8 6 1/2	32 3/4 32 3/4	3 1/4 1 7/8	50 46	A A	C	226530

Vista-Pro Automotive - Core Catalog
(Cores Sorted by Size)

Height	Width	Depth	Application	Description	Fin Type	Fin Matl	Rows	FPI	BH / TH Type	BH / TH Width	BH / TH Length	BH / TH OHF	BH / TH Bolts	BH / TH Shape	Hdr Support	Model #
32	31 1/4	4 7/16	FIAT ALLIS	HVY T/BTM HDRS BRASS FIN	Z	B	6	9	BH	8 1/4	33 3/4	C	44	A	C	282741
					BH	8 1/4	33 3/4	C	44	A						
32	31 1/2	3 3/4	DRESSER INDUSTRIES	HOUGH H-90 HVY BTM HDR	T	C	5	7	BL	8 5/8	34	1 3/4	44	A	C	223587
					BH	8 5/8	34	1 3/4	44	A						
32	31 1/2	4 1/2	CATERPILLAR	D398 HVY T/BTM HDRS 4 CORES PER RAD	T	C	6	8	BH	7 3/8	33 3/4	C	42	A	C	272567
					BH	7 3/8	33 3/4	C	42	A						
32	31 7/8	4 7/16	CATERPILLAR	D398 6L1533 HVY BTM HDR BRASS FIN 4 CORES PER RAD	Z	B	6	9	BL	7 3/8	33 3/4	C	42	A	C	225367
					BH	7 3/8	33 3/4	C	42	A						
32	32 1/16	3 3/4	CATERPILLAR	HVY BTM HDR	T	C	5	9	BL	7 1/4	34 1/2	1 5/16	44	A	C	272801
					BH	7 1/4	34 1/2	1 5/16	44	A						
32	34 5/16	3 3/4	MURPHY DIESEL	NORTHWEST CRANE, AR-608	T	C	5	7	BL	6 3/4	38	1 3/8	34	J	C	270639
					BL	6 3/4	38	1 3/8	34	J						
32	35 7/16	4 1/2	CATERPILLAR	D-6C HVY T/BTM HDRS BRASS FIN	T	B	6	9	BH	6 9/16	36 3/16	C	32	A	C	264006
					BH	6 9/16	36 3/16	C	32	A						
32	35 1/2	4 1/2	CATERPILLAR	D-6C HVY T/BTM HDRS BRASS FIN FACE DIPPED	B	B	6	6	BH	6 9/16	36 3/16	C	32	A	C	229563
					BH	6 9/16	36 3/16	C	32	A						
32	35 1/2	4 1/2	CATERPILLAR	D-6C HVY T/BTM HDRS BRASS FIN	B	B	6	6	BH	6 9/16	36 3/16	C	32	A	C	229595
					BH	6 9/16	36 3/16	C	32	A						
32	35 5/8	4 7/16	CATERPILLAR	D-6 7S2385 HVY T/BTM HDRS BRASS FIN 4 CRNRS OF CORE NOTCHED	Z	B	6	8	BH	6 9/16	36 3/16	C	32	A	C	225051
					BH	6 9/16	36 3/16	C	32	A						
32	35 5/8	4 7/16	CATERPILLAR	D-6 7S2385 HVY T/BTM HDRS HVY STEEL FIN 4 CRNRS OF CORE NOTCHED	Z	S	6	8	BH	6 9/16	36 3/16	C	32	A	C	225848
					BH	6 9/16	36 3/16	C	32	A						
32	37 1/2	4 7/16	EAGLE COACH	BUS HVY BTM HDR BRASS FIN	Z	B	6	9	BL	7 3/8	41	C	52	A	C	288420
					BH	7 3/8	41	C	52	A						
32	37 11/16	3 3/4	EAGLE COACH	HVY BTM HDR	T	C	5	9	BL	7 3/8	41	C	52	A	C	272416
					BH	7 3/8	41	C	52	A						
32	37 11/16	4 1/2	EAGLE COACH	HVY BTM HDR	T	C	6	9	BL	7 3/8	41	C	52	A	C	223625
					BH	7 3/8	41	C	52	A						
32 1/8	26 7/16	4 1/2	CATERPILLAR	D379 4 CORES PER RAD	T	C	6	8	BH	8	28 5/8	C	36	A	C	223110
					BH	8	28 5/8	C	36	A						
32 1/8	26 7/8	3 11/16	CATERPILLAR	D379 4L648 4 CORES PER RAD	Z	C	5	9	BL	8	28 5/8	C	36	A	C	225295
					BL	8	28 5/8	C	36	A						
32 1/8	26 7/8	4 7/16	CATERPILLAR	D379 5L2451 BRASS FIN 4 CORES PER RAD	Z	B	6	9	BL	8	28 5/8	C	36	A	C	225368
					BL	8	28 5/8	C	36	A						
32 1/8	26 7/8	4 5/8	CATERPILLAR	D379 HVY T/BTM HDRS 4 CORES PER RAD	X	C	6	9	BH	8	28 5/8	C	36	A	C	266291
					BH	8	28 5/8	C	36	A						
32 3/16	25 1/2	3	NAVISTAR	S SERIES LOW FLOW CAN USE 284694 DIMPLED TUBE	VH	C	4	15	BL	6 1/8	27 1/2	1 3/8	38	A	N	251014
					BL	6 1/8	27 1/2	1 3/8	38	A						
32 3/16	25 1/2	3	NAVISTAR	E-2511-3	VH	C	4	16	BL	6 1/8	27 1/2	1 1/4	38	A	N	251133
					BL	6 1/8	27 1/2	1 1/4	38	A						
32 3/16	25 5/8	2 7/8	NAVISTAR	S SERIES LOW FLOW CAN USE 284694 DIMPLED TUBE	R	C	5	11	BL	6 1/8	27 1/2	1 3/8	38	A	C	226003
					BL	6 1/8	27 1/2	1 3/8	38	A						
32 3/16	25 5/8	2 7/8	NAVISTAR	E-2511-3	R	C	5	11	BL	6 1/8	27 1/2	1 1/4	38	A	C	226890
					BL	6 1/8	27 1/2	1 1/4	38	A						
32 3/16	26 1/4	3	NAVISTAR	ULTRA-FUSED LOW FLOW CAN USE 251014 DIMPLED TUBE	VH	C	4	16	BL	6 1/8	27 1/2	1 3/8	38	A	N	284694
					BL	6 1/8	27 1/2	1 3/8	38	A						
32 3/16	28 3/4	5 3/16	JOHN DEERE	644D HVY STEEL FIN	Z	S	7	9	GR	5 3/4	29 7/16	C	A	C	225931	
					GR	5 3/4	29 7/16	C	A							
32 1/4	25 5/8	2 3/8	NAVISTAR	2000	R	C	4	11	BL	6 1/8	27 1/2	1 1/4	38	A	C	226657
					BL	6 1/8	27 1/2	1 1/4	38	A						
32 1/4	26 7/8	3 11/16	DRESSER INDUSTRIES	175 LOADER BRASS FIN	Z	B	5	8	BL	9 3/8	29 1/2	2	34	A	C	285062
					GR	5 3/4	27	3/16	A							
32 1/4	27	4 1/2	DRESSER INDUSTRIES	175B LOADER	T	C	6	8	BL	9 3/8	29 1/2	2	34	A	C	265439
					GR	5 3/4	27	3/8	A							
32 1/4	27	4 1/2	DRESSER INDUSTRIES	175B LOADER BRASS FIN FACE DIPPED	B	B	6	6	BL	9 3/8	29 1/2	2 1/8	34	A	C	277065
					GR	5 5/8	27	1/4	A							
32 1/4	28 1/8	3 7/16	BROCKWAY		R	C	6	11	BL	7 3/8	30 1/4	C	42	A	C	226304
					BL	7 3/8	30 1/4	C	42	A						
32 1/4	28 11/16	3 3/4	CASE/INTERNATIONAL	4890, 4WD HVY BTM HDR	T	C	5	9	BL	10 1/4	31 1/2	1 3/8	46	A	C	272789
					BH	6 1/8	31 1/2	C	42	A						
32 1/4	29 13/16	3 3/4	CASE/INTERNATIONAL	4890, 4WD HVY T/BTM HDRS	T	C	5	9	BH	6 3/8	31 7/8	C	48	A	C	272587
					BH	6 3/8	31 7/8	C	48	A						

Vista-Pro Automotive - Core Catalog
(Cores Sorted by Size)

Height	Width	Depth	Application	Description	Fin Type	Fin Matl	Rows	FPI	BH / TH Type	BH / TH Width	BH / TH Length	BH / TH OHF	BH / TH Bolts	BH / TH Shape	Hdr Support	Model #
32 1/4	31 1/4	2 7/8	ADVANCE MIXER	K75 CEMENT TRUCK	R	C	5	10	BL BL	9 1/2 6 5/8	33 33	3 5/16 1 7/8	50 46	A A	C C	226316
32 3/8	31 1/4	4 7/16	CAT-LoMASTER	D-6D 1W9285 GROUP REPL 8 CORES BRASS FINS	Z	B	6	7	BH BH	6 1/2 6 1/2	31 1/2 31 1/2	C C	38 38	0 0	C C	284140
32 3/8	33	4 1/2	KOMATSU	HVY T/BTM HDRS	B	C	6	7	BH BH	6 7/8 6 7/8	35 7/8 35 7/8	C C	38 38	A A	C C	229579
32 1/2	17 1/16	2	CADILLAC		VT	C	3	12	GR GR	2 3/4 2 3/4	18 5/8 18 5/8	C C		A A	N N	124727
32 1/2	17 1/16	2	GM		VT	C	3	16	GR GR	2 3/4 2 3/4	18 5/8 18 5/8	C C		A A	N N	128651
32 1/2	17 1/16	2 5/8	GM		VT	C	4	12	GR GR	2 3/4 2 3/4	18 5/8 18 5/8	C C		A A	N N	122624
32 1/2	27 1/2	2 3/8	CHEV/GMC	ASTRO 684230, 2005701 TEMPLATE #8	R	C	4	10	BL BL	10 3/8 6 1/4	29 5/8 29 5/8	1 1/2 1 1/4	44 40	A A	C C	226364
32 1/2	27 1/2	2 3/8	CHEV/GMC	ASTRO TEMPLATE #10	R	C	4	11	BL BL	10 3/8 6 1/4	29 5/8 29 5/8	1 5/8 1 3/8	44 40	A A	C C	226365
32 1/2	27 1/2	2 7/8	CHEV/GMC	ASTRO	R	C	5	10	BL BL	6 1/8 6 1/8	29 7/16 29 7/16	1 7/16 1 7/16	38 40	A A	C C	226366
32 1/2	27 1/2	2 7/8	CHEV/GMC	ASTRO 9500 TEMPLATE #10	R	C	5	8	BL BL	10 3/8 6 1/4	29 5/8 29 5/8	1 1/4 1 1/4	44 40	A A	C C	226369
32 1/2	27 1/2	2 7/8	CHEV/GMC	ASTRO 9500 TEMPLATE #8	R	C	5	10	BL BL	10 3/8 6 1/4	29 5/8 29 5/8	1 1/2 1 1/4	44 40	A A	C C	226370
32 1/2	27 1/2	2 7/8	GALION	T500 G-79356	S	C	5	9	GR GR	4 1/4 4 1/4	28 1/4 28 1/4	C C		A A	C C	229067
32 1/2	27 1/2	2 15/16	GALION		Z	C	4	10	GR GR	4 1/4 4 1/4	28 1/4 28 1/4	C C		A A	C C	286563
32 1/2	27 1/2	3 7/16	GALION	T500 D-73488-A	S	C	6	10	GR GR	4 1/4 4 1/4	28 1/4 28 1/4	C C		A A	C C	229068
32 1/2	27 1/2	3 3/4	GALION	GRADER	X	C	5	9	GR GR	4 1/4 4 1/4	28 1/4 28 1/4	C C		A A	C C	289602
32 1/2	28 1/8	2 1/4	CHEV/GMC	9000	T	C	3	9	BL BL	7 5 1/2	30 1/2 30 1/2	2 7/8 2	46 42	A A	C C	263878
32 1/2	28 1/8	2 7/8	CHEV/GMC	ASTRO 9500	R	C	5	10	BL BL	7 5 1/2	30 1/2 30 1/2	C C	46 42	A A	C C	226330
32 1/2	29	5 1/4	JOHN DEERE	LOADER BRASS FINS FACE DIPPED	B	B	7	7	GR GR	5 3/4 5 3/4	29 5/8 29 5/8	C C		A A	C C	272507
32 1/2	30 5/8	3 7/16	CASE/INTERNATIONAL	1620 1979553-C1, A-189018	S	C	6	6	GR GR	5 13/16 5 13/16	31 7/16 31 7/16	3/8 3/8		A A	C C	229203
32 1/2	30 5/8	4 7/16	CASE/INTERNATIONAL	1640-1660 84576-C1 A-189069 BRASS FINS	Z	B	6	6	GR GR	5 13/16 5 13/16	31 7/16 31 7/16	5/8 5/8		A A	C C	225008
32 1/2	34 3/8	4 7/16	FIAT ALLIS	HD-11 HVY T/BTM HDRS BRASS FINS	Z	B	6	7	BH BH	7 5/8 7 5/8	37 7/8 37 7/8	1 5/16 1 5/16	48 48	A A	C C	289448
32 1/2	34 1/2	4 1/2	FIAT ALLIS	HD-11B HVY T/BTM HDRS BRASS FINS FACE DIPPED	B	B	6	6	BH BH	7 5/8 7 5/8	37 7/8 37 7/8	C C	48 48	A A	C C	277122
32 1/2	34 3/4	2 1/4	WESTERN STAR	ULTRA-FUSED CAN USE 226151	VH	C	3	13	BL BL	7 6 5/8	37 7/8 37 7/8	2 1/4 2 1/4	46 46	A A	N N	284531
32 1/2	34 7/8	4 1/2	FIAT ALLIS	HD-11 HVY T/BTM HDRS BRASS FINS	T	B	6	7	BH BH	7 5/8 7 5/8	37 7/8 37 7/8	C C	48 48	A A	C C	265351
32 1/2	35	2 1/4	WESTERN STAR	CAN USE 226151	VH	C	3	14	BL BL	7 6 5/8	37 7/8 37 7/8	2 1/4 2 1/4	46 46	A A	N N	251119
32 1/2	35 1/2	3	WESTERN STAR	CORNERSTONE LOW FLOW DIMPLED TUBE	VH	C	4	15	BL BL	7 6 5/8	37 7/8 37 7/8	C C	46 46	A A	N N	251018
32 1/2	35 5/8	2 3/8	WESTERN STAR	CORNERSTONE	R	C	4	11	BL BL	7 6 5/8	38 38	2 1/4 2 1/4	46 46	A A	C C	226151
32 1/2	35 5/8	2 7/8	WESTERN STAR	CORNERSTONE LOW FLOW DIMPLED TUBE	R	C	5	11	BL BL	7 6 5/8	38 38	C C	46 46	A A	C C	226008
32 1/2	35 5/8	2 7/8	WESTERN STAR	CORNERSTONE	R	C	5	11	BL BL	7 6 5/8	37 7/8 37 7/8	C C	46 46	A A	C C	226786
32 1/2	36 1/4	2 3/8	WESTERN STAR	TEMPLATE #19	R	C	4	11	BL BL	12 1/2 6 5/8	37 7/8 37 7/8	1 7/8 1 7/8	52 46	A A	C C	226787
32 1/2	36 1/4	2 7/8	WESTERN STAR	TEMPLATE #19	R	C	5	11	BL BL	12 1/2 6 5/8	37 7/8 37 7/8	1 7/8 1 7/8	52 46	A A	C C	226788
32 1/2	40	3 7/16	AUTOCAR	HVY BTM HDR	R	C	6	11	BL BH	7 1/16 7 1/16	44 3/8 44 3/8	2 3/8 2 3/8	62 62	C C	C C	226274

Vista-Pro Automotive - Core Catalog
(Cores Sorted by Size)

Height	Width	Depth	Application	Description	Fin Type	Fin Matl	Rows	FPI	BH / TH Type	BH / TH Width	BH / TH Length	BH / TH OHF	BH / TH Bolts	BH / TH Shape	Hdr Support	Model #
32 1/2	40	3 7/16	AUTOCAR	N-151918-DO4 HVY BTM HDR TEMPLATE #1	R	C	6	9	BL BH	10 7 1/16	45 44 3/8	2 3/8 2 3/8	60 56	I C	C	226275
32 1/2	40 1/2	3 3/4	AUTOCAR	HVY BTM HDR TEMPLATE #1	T	C	5	9	BL BH	10 7 1/16	45 44 3/8	2 2 1/2	60 56	I C	CC	223043
32 1/2	22 1/2	2 3/8	PETERBUILT		R	C	4	11	SQ SQ	2 7/8 2 7/8	22 3/4 22 3/4	C C		A A	C	224502
32 5/8	26 7/8	3 11/16	JOHN DEERE	6600 COMBINE AH85641	Z	C	5	7	GR GR	4 1/4 4 1/4	28 1/4 28 1/4	C C		A A	C	225472
32 5/8	27	3 3/4	JOHN DEERE	7700 COMBINE AH124728	T	C	5	6	GR GR	4 1/4 4 1/4	28 1/4 28 1/4	1/8 1/8		A A	C	223215
32 3/4	20 1/2	6	JOHN DEERE	850 AT80348 HVY T/BTM HDRS BRASS FINS FACE DIPPED	B	B	8	7	BH BH	9 1/8 9 1/8	22 1/2 22 1/2	C C	40 40	A A	C	272508
32 3/4	25	4 7/16	CASE/INTERNATIONAL	1470, 1480 COMBINE 130869-C2 146529-C2 BRASS FINS	Z	B	6	6	GR GR	5 7/8 5 7/8	25 3/4 25 3/4	C C		A A	C	225011
32 3/4	25	4 7/16	INT'L HARVESTER	1460, 1480 121722-C3, 130869-C2, 146529-C2	S	C	8	7	GR GR	5 7/8 5 7/8	25 3/4 25 3/4	3/4 3/4		A A	C	229111
32 3/4	25 5/16	4 1/2	INT'L HARVESTER	1486 COMBINE	T	C	6	7	GR GR	5 7/8 5 7/8	25 3/4 25 3/4	3/4 3/4		A A	C	223182
32 3/4	28 1/8	2 7/8	AMERICAN LaFRANCE	FIRE ENGINE	R	C	5	11	GR GR	4 3/4 4 3/4	28 1/4 28 1/4	C C		A A	C	226318
32 3/4	28 1/2	2 1/4	KENWORTH	T400 X-3806, E-2655	VH	C	3	14	BL BL	7 3/8 7 3/8	32 1/8 32 1/8	2 1/2 2 1/2	40 40	A A	N	251000
32 3/4	28 1/2	3	KENWORTH	LOW FLOW 2 PASS CAN USE 284808 DIMPLED TUBE	VH	C	4	15	BL BL	7 3/8 7 3/8	32 1/8 32 1/8	C C	40 40	A A	N	251015
32 3/4	28 5/8	2 1/4	KENWORTH	USE 251015 DIMPLED TUBE	VTH	C	3	16	BL BL	7 3/8 7 3/8	32 1/8 32 1/8	C C	40 40	A A	N	253015
32 3/4	28 5/8	3	KENWORTH	USE 251015 DIMPLED TUBE	VTH	C	4	15	BL BL	7 3/8 7 3/8	32 1/8 32 1/8	C C	40 40	A A	N	252015
32 3/4	28 5/8	1 1/2	KENWORTH	SEE 251000	VTH	C	2	16	BL BL	7 3/8 7 3/8	32 1/8 32 1/8	2 1/2 2 1/2	40 40	A A	N	253000
32 3/4	28 5/8	2 1/4	KENWORTH	SEE 251000	VTH	C	3	14	BL BL	7 3/8 7 3/8	32 1/8 32 1/8	2 1/2 2 1/2	40 40	A A	N	252000
32 3/4	28 3/4	2 3/8	KENWORTH	T400 X-3806, E-2655	R	C	4	11	BL BL	7 3/8 7 3/8	32 1/8 32 1/8	2 1/2 2 1/2	40 40	A A	C	226891
32 3/4	28 3/4	2 7/8	KENWORTH	LOW FLOW 2 PASS CAN USE 284808 DIMPLED TUBE	R	C	5	11	BL BL	7 3/8 7 3/8	32 1/8 32 1/8	C C	40 40	A A	C	226004
32 3/4	28 3/4	2 7/8	KENWORTH	W900S	R	C	5	11	BL BL	7 3/8 7 3/8	32 1/8 32 1/8	2 1/2 2 1/2	40 40	A A	C	226101
32 3/4	29 1/16	2 1/4	KENWORTH	T-400 X-3806 ULTRA-FUSED CAN USE 251000	VH	C	3	16	BL BL	7 3/8 7 3/8	32 1/8 32 1/8	2 1/2 2 1/2	40 40	A A	N	284095
32 3/4	29 1/16	3	KENWORTH	W900S ULTRA-FUSED CAN USE 226101	VH	C	4	11	BL BL	7 5/16 7 5/16	32 1/8 32 1/8	2 1/2 2 1/2	40 40	A A	N	284519
32 3/4	29 1/16	3	KENWORTH	ULTRA-FUSED LOW FLOW TWO PASS CAN USE 251015 DIMPLED TUBE	VH	C	4	13	BL BL	7 5/16 7 5/16	32 1/8 32 1/8	C C	40 40	A A	N	284808
32 3/4	42 3/16	3	CHEV/GMC	GENERAL HVY BTM HDR	T	C	4	11	BL BH	7 7	45 1/4 45 1/4	1 3/4 1 3/4	60 60	B B	CC	223125
32 3/4	42 1/2	2 1/4	GMC TRUCK	GENERAL LOW FLOW CAN USE 284021 DIMPLED TUBE	VH	C	3	15	BL BL	7 7	45 1/4 45 1/4	1 5/8 1 5/8	60 60	B B	N	251022
32 3/4	42 1/2	2 3/8	CHEV/GMC	GENERAL LOW FLOW CAN USE 284021 DIMPLED TUBE	R	C	4	11	BL BL	7 7	45 1/4 45 1/4	1 5/8 1 5/8	60 60	B B	CC	226015
32 3/4	42 1/2	2 7/8	CHEV/GMC	GENERAL LOW FLOW CAN USE 284025 DIMPLED TUBE	R	C	5	11	BL BL	7 7	45 1/4 45 1/4	1 5/8 1 5/8	60 60	B B	CC	226016
32 3/4	42 1/2	2 7/8	CHEV/GMC	GENERAL	R	C	5	11	BL BL	7 7	45 1/4 45 1/4	1 5/8 1 5/8	60 60	B B	CC	226116
32 3/4	42 1/2	2 7/8	CHEV/GMC	GENERAL LOW FLOW HDRS CTRD PER CHAS BRASWELL DIMPLED TUBE	R	C	5	11	BL BL	7 7	45 1/4 45 1/4	1 5/8 1 5/8	60 60	B B	CC	226043
32 3/4	42 1/2	3	GMC TRUCK	GENERAL LOW FLOW CAN USE 284025 DIMPLED TUBE	VH	C	4	15	BL BL	7 7	45 1/4 45 1/4	1 5/8 1 5/8	60 60	B B	N	251023
32 3/4	42 3/4	2 1/4	CHEV/GMC	GENERAL ULTRA-FUSED LOW FLOW CAN USE 251022 DIMPLED TUBE	VH	C	3	13	BL BL	7 7	45 1/4 45 1/4	1 5/8 1 5/8	60 60	B B	N	284021
32 7/8	20	5 3/16	JOHN DEERE	HVY BTM HDR BRASS FINS	Z	B	7	6	BL BH	9 1/8 9 1/8	22 1/2 22 1/2	C C	40 40	A A	C	225631

Vista-Pro Automotive - Core Catalog
(Cores Sorted by Size)

Height	Width	Depth	Application	Description	Fin Type	Fin Matl	Rows	FPI	BH / TH Type	BH / TH Width	BH / TH Length	BH / TH OHF	BH / TH Bolts	BH / TH Shape	Hdr Support	Model #
33 7/16	27 1/2	3 11/16	CATERPILLAR	D-5 6N543, 8N8842 HVY T/BTM HDRS HVY STEEL FINS 4 CRNRS OF CORE NOTCHED	Z	S	5	8	BH BH	6 9/16 6 9/16	29 3/8 29 3/8	C C	34 34	A F	C	225893
33 7/16	27 1/2	3 3/4	CATERPILLAR	D-5 HVY T/BTM HDRS BRASS FINS FACE DIPPED	B	B	5	7	BH BH	6 9/16 6 9/16	29 3/8 29 3/8	C C	34 34	A A	C	272612
33 7/16	33 1/8	2 3/16	CATERPILLAR	140 GRADER 8N73	Z	C	3	9	GR GR	4 4	35 1/2 35 1/2	C C		A A	C	225298
33 7/16	33 1/8	2 3/16	CATERPILLAR	140 GRADER 8N73 HVY STEEL FINS	Z	S	3	9	GR GR	4 4	35 1/2 35 1/2	C C		A A	C	225896
33 7/16	33 1/8	2 15/16	CATERPILLAR	140 GRADER 4Q5026 HVY STEEL FINS	Z	S	4	9	GR GR	4 4	35 1/2 35 1/2	C C		0 0	C	225895
33 7/16	33 1/8	3 11/16	CATERPILLAR	140G GRADER 7W2949 BRASS FINS	Z	B	5	8	GR GR	4 4	35 1/2 35 1/2	C C		A A	C	225379
33 7/16	33 1/2	3	CATERPILLAR	245 EXCAVATOR	B	C	4	7	GR GR	4 4	35 1/2 35 1/2	C C		A A	C	229504
33 7/16	33 1/2	3 3/4	CATERPILLAR	14G GRADER	B	C	5	8	GR GR	4 4	35 1/2 35 1/2	C C		A A	C	272803
33 1/2	23 3/4	2 7/8	MACK TRUCKS	2MF-5254, X-1962	R	C	5	9	GR GR	6 7/8 3 5/8	24 1/4 24 1/4	5/8 5/8		A A	C	226588
33 1/2	26 1/4	2 1/4	NAVISTAR		X	C	3	10	BL BL	6 1/4 6 1/4	28 3/4 28 3/4	1 1/8 1 1/8	38 38	A A	C	266036
33 1/2	26 7/16	3	NAVISTAR		T	C	4	9	BL BL	6 1/4 6 1/4	28 3/4 28 3/4	1 1/4 1 1/4	38 38	A A	C	223295
33 1/2	26 7/8	1 3/4	VOLVO WHITEGMC		R	C	3	11	SQ SQ	3 1/2 3 1/2	27 27	FF FF		A A	C	226743
33 1/2	33 3/16	5 1/4	CATERPILLAR	16G GRADER HVY T/BTM HDRS BRASS FINS	T	B	7	8	BH BH	8 8	40 35 1/4	C C	38 34	F F	C	265178
33 1/2	39 3/8	3	CATERPILLAR	D13000 HVY BTM HDR	T	C	4	7	BL BH	6 1/8 6 1/8	43 43	C C	36 36	H H	C	271350
33 5/8	26 1/4	2 3/8	NAVISTAR		R	C	4	10	BL BL	6 1/4 6 1/4	28 3/4 28 3/4	1 1/8 1 1/8	38 38	A A	C	226658
33 5/8	26 1/4	2 7/8	NAVISTAR		R	C	5	11	BL BL	10 6 1/4	28 3/4 28 3/4	1 1/8 1 1/8	42 38	A A	C	226190
33 5/8	26 1/4	2 7/8	NAVISTAR	2070	R	C	5	10	BL BL	6 1/4 6 1/4	28 3/4 28 3/4	1 1/8 1 1/8	38 38	A A	C	226191
33 5/8	26 1/4	2 7/8	NAVISTAR	6 1/4" X 9" CRANK BOX	R	C	5	11	BL BL	6 1/8 6 1/8	28 3/4 28 3/4	1 1/8 1 1/8	38 38	A A	C	226832
33 5/8	33 1/8	2 15/16	CATERPILLAR	245 EXCAVATOR 7N7330	Z	C	4	9	GR GR	4 4	35 1/2 35 1/2	C C		A A	C	225047
33 5/8	33 1/8	3 11/16	CATERPILLAR	245 EXCAVATOR 2P9586	Z	C	5	9	GR GR	4 4	35 1/2 35 1/2	C C		A A	C	225073
33 5/8	33 3/16	3 3/4	CATERPILLAR	245 EXCAVATOR HVY STEEL FINS	T	S	5	9	GR GR	4 4	35 1/2 35 1/2	C C		A A	C	265651
33 3/4	27 1/2	2 1/4	CATERPILLAR	D-5 HVY T/BTM HDRS BRASS FINS FACE DIPPED	B	B	3	7	BH BH	5 3/4 5 3/4	29 3/8 29 3/8	C C	28 28	F F	C	278825
33 3/4	27 1/2	2 15/16	CATERPILLAR	D-5 HVY T/BTM HDRS BRASS FINS 4 CRNRS OF CORE NOTCHED	Z	B	4	9	BH BH	5 3/4 5 3/4	29 3/8 29 3/8	C C	28 28	F F	C	225107
33 3/4	27 1/2	3 11/16	CATERPILLAR	D-5 5S8450 HVY T/BTM HDRS BRASS FINS 4 CRNRS OF CORE NOTCHED	Z	B	5	8	BH BH	5 3/4 5 3/4	29 3/8 29 3/8	C C	28 28	F F	C	225611
33 3/4	27 1/2	3 11/16	CATERPILLAR	D-5 5S8450 HVY T/BTM HDRS HVY STEEL FINS 4 CRNRS OF CORE NOTCHED	Z	S	5	8	BH BH	5 3/4 5 3/4	29 3/8 29 3/8	C C	28 28	F F	C	225839
33 3/4	27 1/2	3 3/4	CATERPILLAR	D-5 HVY T/BTM HDRS BRASS FINS 4 CRNRS OF CORE NOTCHED	B	B	5	6	BH BH	5 3/4 5 3/4	29 3/8 29 3/8	C C	28 28	F F	C	229596
33 3/4	68 3/4	3 11/16	CUMMINS ENGINE	POWER UNIT HVY T/BTM HDRS 2 CORES PER RAD	Z	C	5	9	BH BH	11 5/8 9	71 3/4 71 3/4	1 7/8 1 7/8	84 80	A A	CC	225453
33 7/8	35 5/8	5 3/16	CAT-LEMASTER	3406 GEN SET REPL 8 CORES BRASS FINS	Z	B	7	7	BH BH	7 7	36 3/8 36 3/8	C C	42 42	0 0	C	284132
33 7/8	36	5 1/4	CAT-LEMASTER	3406 GEN SET REPL 8 CORES BRASS FINS	T	B	7	7	BH BH	7 7	36 36	C C	42 42	0 0	C	274132
33 15/16	33 3/16	4 1/2	GROVE WORLDWIDE	CRANE	T	C	6	8	BL BL	7 1/4 7 1/4	36 36	C C	48 48	A A	C	223228

Vista-Pro Automotive - Core Catalog
(Cores Sorted by Size)

Height	Width	Depth	Application	Description	Fin Type	Fin Matl	Rows	FPI	BH / TH Type	BH / TH Width	BH / TH Length	BH / TH OHF	BH / TH Bolts	BH / TH Shape	Hdr Support	Model #
34	15 5/8	5 3/16	JOHN DEERE	750 CRAWLER BRASS FINS	Z	B	7	9	BL BL	8 8	17 17	C C	24 24	A A	C	225428
34	16 5/16	5 1/4	JOHN DEERE	750 CRAWLER AT52689 HVY BTM HDR	T	C	7	8	BL BH	8 8	17 17	C C	24 24	A A	C	223616
34	16 5/16	5 1/4	JOHN DEERE	750 CRAWLER AT52689 HVY BTM HDR BRASS FINS FACE DIPPED	T	B	7	8	BL BH	8 8	17 17	C C	24 24	A A	C	223622
34	16 1/2	5 1/4	JOHN DEERE	HVY T/BTM HDRS BRASS FINS FACE DIPPED	B	B	7	7	BH BH	8 8	17 17	C C	24 24	A A	C	272896
34	16 15/16	2 1/4	GM		VE	C	4	14	GR GR	3 1/2 3 1/2	18 5/8 18 5/8	3/8 3/8		A A	N	128175
34	16 15/16	2 1/4	GM	VE CORE;4R-14 FPI	VE	C	4	14	GR GR	3 7/16 3 7/16	18 5/8 18 5/8	C C		A A	N	128585
34	16 15/16	2 3/4	GM		VE	C	5	14	GR GR	3 7/16 3 7/16	18 5/8 18 5/8	FF FF		A A	N	128817
34	17 1/16	2	OLDSMOBILE		VT	C	3	13	GR GR	3 1/2 2 3/4	18 5/8 18 5/8	3/8 C		A A	N	124555
34	17 1/16	2	OLDSMOBILE		VT	C	3	15	GR GR	3 1/2 3 1/2	18 5/8 18 5/8	C C		A A	N	124709
34	17 1/16	2	TORONADO		VT	C	3	15	GR GR	2 3/4 2 3/4	18 5/8 18 5/8	C C		A A	N	124726
34	17 1/16	2 5/8	GM		VT	C	4	12	GR GR	2 3/4 3 1/2	18 5/8 18 5/8	C C		A A	N	122612
34	17 1/16	2 5/8	GM		VT	C	4	12	GR GR	2 3/4 2 3/4	18 5/8 18 5/8	C C		A A	N	122623
34	17 1/16	2 5/8	GM		VT	C	4	15	GR GR	3 1/2 3 1/2	18 5/8 18 5/8	C C		A A	N	124931
34	17 3/8	1 9/16	GM		VE	C	3	14	GR GR	3 7/16 3 7/16	18 5/8 18 5/8	7/16 7/16		A A	N	128586
34	17 1/2	5 3/16	JOHN DEERE	HVY STEEL FINS 4 CRNRS OF CORE NOTCHED	Z	S	7	8	BL BL	8 1/8 8 1/8	18 9/16 18 9/16	C C	32 32	A A	C	225920
34	19	1 9/16	CHEV/GMC		VE	C	3	14	GR GR	3 1/2 3 1/2	20 7/8 20 7/8	C C		A A	N	128299
34	19	1 9/16	GM		VE	C	3	16	GR GR	2 3/8 2 3/8	20 5/8 20 5/8	C C		A A	N	128758
34	19	2 1/4	GM	VE CORE;4R-14 FPI	VE	C	4	14	GR GR	3 1/2 3 1/2	20 7/8 20 7/8	7/16 7/16		A A	N	128280
34	19	2 3/4	GM		VE	C	5	14	GR GR	3 1/2 3 1/2	20 7/8 20 7/8	3/8 3/8		A A	N	128818
34	19 1/4	2	CHEV/GMC		VT	C	3	12	GR GR	3 1/2 3 1/2	20 7/8 20 7/8	3/8 3/8		A A	N	128816
34	19 1/4	2 5/8	GM	TRUCK	VT	C	4	12	GR GR	3 1/2 3 7/16	20 7/8 20 7/8	C C		A A	N	128148
34	24 3/16	2	CHEV/GMC	CHEV TRK	VT	C	3	12	GR GR	3 1/2 3 1/2	25 3/4 25 3/4	1/4 1/4		A A	N	124556
34	24 3/16	2 5/8	CHEV/GMC	CHEV TRK	VT	C	4	12	GR GR	3 1/2 3 1/2	25 3/4 25 3/4	1/2 1/2		A A	N	124557
34	24 3/16	2 5/8	GM		VT	C	4	12	GR GR	3 1/2 3 1/2	25 3/4 25 3/4	C C		A A	N	128753
34	25	3 15/16	HERCULES ENGINE	4800 40-3902003	S	C	7	10	GR GR	4 5/16 4 5/16	25 3/4 25 3/4	C C		A A	C	229077
34	29 1/4	3	NAVISTAR	DC400 TEMPLATE #16	T	C	4	10	BL BL	10 3/8 6 7/8	31 1/4 31 1/4	1 1/2 1 1/2	44 40	A A	C	263940
34	29 3/8	2 3/8	NAVISTAR	TEMPLATE #17	R	C	4	10	BL BL	10 3/8 6 7/8	31 1/4 31 1/4	1 3/8 1 3/8	44 40	A A	C	226661
34	31 1/4	4 7/16	TEREX	HVY T/BTM HDRS BRASS FINS	Z	B	6	8	BH BH	8 3/8 8 3/8	35 5/8 35 5/8	C C	46 46	B B	C	281976
34	31 1/2	4 1/2	JOHN DEERE	5400	B	C	6	7	GR GR	6 6	32 1/2 32 1/2	C C		A A	C	272898
34	33	4 1/2	CATERPILLAR	235 EXCAVATOR HVY T/BTM HDRS BRASS FINS FACE DIPPED	B	B	6	7	BH BH	8 3/8 8 3/8	36 36	C C	36 36	A A	C	272570
34	33	5 1/4	CATERPILLAR	235 EXCAVATOR HVY T/BTM HDRS BRASS FINS FACE DIPPED	B	B	7	7	BH BH	8 3/8 8 3/8	36 36	C C	36 36	A A	C	272571

Vista-Pro Automotive - Core Catalog
(Cores Sorted by Size)

Height	Width	Depth	Application	Description	Fin Type	Fin Matl	Rows	FPI	BH / TH Type	BH / TH Width	BH / TH Length	BH / TH OHF	BH / TH Bolts	BH / TH Shape	Hdr Support	Model #
34	33 1/8	5 3/16	CATERPILLAR	235 EXCAVATOR 7W8891 HVY T/BTM HDRS BRASS FINS	Z	B	7	10	BH BH	8 3/8 8 3/8	36 36	C C	36 36	A A	C C	225141
34	33 1/8	5 3/16	CATERPILLAR	235 EXCAVATOR 2P5218 HVY T/BTM HDRS HVY STEEL FINS	Z	S	7	10	BH BH	8 3/8 8 3/8	36 36	C C	36 36	A A	C C	225841
34	33 3/16	5 1/4	CATERPILLAR	235 EXCAVATOR HVY T/BTM HDRS BRASS FINS	T	B	7	9	BH BH	8 3/8 8 3/8	36 36	C C	36 36	A A	C C	265670
34	34 3/4	3	WESTERN STAR	CORNERSTONE CAN USE 226193	VH	C	4	14	BL BL	6 5/8 6 5/8	37 7/8 37 7/8	C C	46 46	A A	N N	284040
34	34 3/4	3	WESTERN STAR	CORNERSTONE ULTRA-FUSED LOW FLOW CAN USE 251039 DIMPLED TUBE	VH	C	4	13	BL BL	6 5/8 6 5/8	37 7/8 37 7/8	C C	46 46	A A	N N	284060
34	34 15/16	2 1/4	WESTERN STAR	SEE 251129	VTH	C	3	16	BL BL	6 5/8 6 5/8	37 7/8 37 7/8	C C	46 46	A A	N N	253129
34	34 15/16	3	WESTERN STAR	SEE 251129	VTH	C	4	14	BL BL	6 5/8 6 5/8	37 7/8 37 7/8	C C	46 46	A A	N N	252129
34	35	3	WESTERN STAR	CORNERSTONE LOW FLOW CAN USE 284060 DIMPLED TUBE	VH	C	4	15	BL BL	6 5/8 6 5/8	37 7/8 37 7/8	C C	46 46	A A	N N	251039
34	35	3	WESTERN STAR	CORNERSTONE CAN USE 226193	VH	C	4	14	BL BL	6 5/8 6 5/8	37 7/8 37 7/8	C C	46 46	A A	N N	251129
34	35	4 7/16	KOEHRING	CRANE BRASS FINS	Z	B	6	9	BL BL	7 1/2 7 1/2	38 38	C C	48 48	A A	C C	282679
34	35 5/8	2 7/8	WESTERN STAR	CORNERSTONE LOW FLOW DIMPLED TUBE	R	C	5	11	BL BL	6 5/8 6 5/8	37 7/8 37 7/8	C C	46 46	A A	C C	226039
34	35 5/8	2 7/8	WESTERN STAR	CORNERSTONE	R	C	5	11	BL BL	6 5/8 6 5/8	37 7/8 37 7/8	C C	46 46	A A	C C	226193
34	40	6	EUCLID	TEREX HVY T/BTM HDRS	B	C	8	8	BH BH	10 1/2 10 1/2	43 3/4 43 3/4	C C	52 52	A A	C C	229573
34	45	4 7/16	SEAGRAVE	HVY BTM HDR BRASS FINS	Z	B	6	11	BL BH	7 5/8 7 5/8	48 48	C C	58 58	A A	CC A	281931
34 1/4	27 1/2	3 11/16	JOHN DEERE	8630	Z	C	5	11	SQ SQ	4 1/4 4 1/4	28 28	C C		A A	C C	286895
34 1/4	27 1/2	3 3/4	JOHN DEERE	8430, 8630	X	C	5	9	GR GR	4 1/4 4 1/4	28 28	C C		A A	C C	221514
34 1/4	27 1/2	3 15/16	JOHN DEERE	8630 AR76840	S	C	7	9	GR GR	4 1/4 4 1/4	28 28	C C		A A	C C	229025
34 1/4	27 9/16	3 3/4	JOHN DEERE	8430, 8630	T	C	5	9	GR GR	4 1/4 4 1/4	28 28	C C		A A	C C	272509
34 1/4	34 5/16	4 1/2	DETROIT DIESEL	DOWELL DRILL W/6V-71 HVY T/BTM HDRS	T	C	6	9	BH BH	7 5/8 7 5/8	36 36	C C	58 58	A A	C C	223096
34 1/4	35	3 7/16	NEOPLAN BUS	W/6V-92 DETROIT DIESEL	R	C	6	10	BL BL	6 5/8 6 5/8	37 37	C C	44 44	A A	C C	226697
34 1/4	38 1/4	3 3/4	FIAT ALLIS	261 SCRAPER HVY BTM HDR	T	C	5	9	BL BH	8 1/4 8 1/4	41 1/2 41 1/2	C C	54 54	A A	C C	278644
34 1/2	19 3/8	3	JOHN DEERE	554-E	X	C	4	7	GR GR	4 3/4 4 3/4	20 20	3/16 3/16		A A	C C	282769
34 1/2	28 1/8	2 7/8	FREIGHTLINER	BLACK CORE HVY BTM HDR	R	C	5	11	BL BH	6 3/4 6 3/4	30 1/2 30 1/2	C C	34 34	F F	C C	226501
34 1/2	28 1/8	3 15/16	FREIGHTLINER	RED CORE A05-09610 HVY BTM HDR	R	C	7	11	BL BH	6 3/4 6 3/4	30 1/2 30 1/2	C C	34 34	F F	C C	226503
34 1/2	28 1/8	4 1/2	FREIGHTLINER	RED CORE HVY BTM HDR	T	C	6	10	BL BH	6 3/4 6 3/4	30 1/2 30 1/2	C C	34 34	A A	C C	223297
34 1/2	28 3/4	4 7/16	FREIGHTLINER	RED CORE HVY BTM HDR	R	C	8	10	BL BH	6 3/4 6 3/4	30 1/2 30 1/2	C C	34 34	F F	C C	226335
34 9/16	34 1/2	3 3/4	CATERPILLAR	D-8 HVY T/BTM HDRS BRASS FINS	B	B	5	6	BH BH	6 5/16 6 5/16	36 36	C C	32 32	W W	C C	229597
34 5/8	23	3 3/4	TERRA-GATOR/TERRA-TR	CAT ENGINE HVY T/BTM HDRS	B	C	5	7	BH BH	6 1/4 6 1/4	25 1/4 25 1/4	C C	34 34	A A	C C	272946
34 5/8	34 3/8	4 7/16	KOMATSU	350 BRASS FINS	Z	B	6	7	GR GR	5 1/8 5 1/8	35 35	3/8 3/8		A A	C C	282579
34 3/4	26 7/16	4 1/2	CATERPILLAR	D-6C HVY T/BTM HDRS BRASS FINS 4 CRNRS OF CORE NOTCHED	T	B	6	9	BH BH	6 9/16 6 9/16	28 28	C C	30 30	F W	C C	223111

Vista-Pro Automotive - Core Catalog
(Cores Sorted by Size)

Height	Width	Depth	Application	Description	Fin Type	Fin Matl	Rows	FPI	BH / TH Type	BH / TH Width	BH / TH Length	BH / TH OHF	BH / TH Bolts	BH / TH Shape	Hdr Support	Model #
34 3/4	26 1/2	4 1/2	CATERPILLAR	D-6C HVY T/BTM HDRS BRASS FINS FACE DIPPED 4 CRNRS OF CORE NOTCHED	B	B	6	6	BH	6 5/8	28	C	30	A	C	229537
34 3/4	26 1/2	4 1/2	CATERPILLAR	D-6C HVY T/BTM HDRS BRASS FINS 4 CRNRS OF CORE NOTCHED	B	B	6	6	BH	6 9/16	28	C	30	A	C	229599
34 3/4	26 7/8	4 7/16	CATERPILLAR	D-6C 4N6298 HVY T/BTM HDRS BRASS FINS 4 CRNRS OF CORE NOTCHED	Z	B	6	9	BH	6 9/16	28	C	30	F	C	225081
34 3/4	31 1/4	4 7/16	CATERPILLAR	D-6C 7N3542 HVY T/BTM HDRS BRASS FINS 4 CRNRS OF CORE NOTCHED	Z	B	6	9	BH	6 9/16	33 1/8	C	36	F	C	225194
34 3/4	31 1/4	4 7/16	CATERPILLAR	D-6C 7N4384 HVY T/BTM HDRS HVY STEEL FINS 4 CRNRS OF CORE NOTCHED	Z	S	6	9	BH	6 9/16	33 1/8	C	36	F	C	225874
34 3/4	31 1/2	3	CATERPILLAR	D-6C HVY T/BTM HDRS BRASS FINS 4 CRNRS OF CORE NOTCHED	B	B	4	7	BH	6 9/16	33 1/8	C	36	F	C	229598
34 3/4	31 1/2	4 1/2	CATERPILLAR	D-6C HVY T/BTM HDRS BRASS FINS FACE DIPPED 4 CRNRS OF CORE NOTCHED	B	B	6	7	BH	6 5/8	33 1/16	C	36	A	C	229505
34 13/16	23 5/8	3	NAVISTAR		T	C	4	11	BL	8 3/8	26	1 1/2	46	A	C	263283
34 13/16	23 5/8	3 3/4	NAVISTAR	DCF405	T	C	5	9	BL	8 3/8	26	1 1/2	46	A	C	275223
35	29 1/4	3	WESTERN STAR	9000 SERIES TEMPLATE #20	T	C	4	10	BL	10 3/8	31 1/4	2 7/16	54	B	C	263877
35	29 3/8	4 7/16	LINK-BELT	BRASS FINS	Z	B	6	9	GR	4 7/8	29 3/4	C		A	C	282696
35	34 5/16	4 1/2	DETROIT DIESEL	HVY BTM HDR	T	C	6	9	BL	8	36 1/2	C	50	A	C	278977
35	34 3/8	2 15/16	CUMMINS ENGINE	GROVE CRANE HVY T/BTM HDRS	Z	C	4	9	BH	7 3/4	36	1 5/8	48	A	C	225435
35	34 7/8	3 3/4	HAPPY YOUNG	36-42 HVY T/BTM HDRS	T	C	5	7	BH	6 1/2	37 5/8	C	38	A	C	270207
35	35	2 7/8	GROVE WORLDWIDE	800 CRANE W/CUMMINS ENGINE HVY BTM HDR	S	C	5	9	BL	7 3/4	36	1 5/8	48	A	C	272879
35	39 3/8	2 7/8	OSHKOSH TRUCK	CEMENT MIXER LOW FLOW DIMPLED TUBE	R	C	5	11	BL	7 3/4	42 1/2	C	54	A	C	226038
35	39 15/16	3	KENWORTH	1400, D-2245 HVY BTM HDR	T	C	4	10	BL	7 7/8	43 1/2	1 3/4	40	A	C	265353
35	39 15/16	4 1/2	KENWORTH	1400 HVY BTM HDR	T	C	6	9	BL	7 7/8	43 1/2	C	40	A	C	223242
35	39 15/16	4 1/2	KENWORTH	K94, C-9 HVY BTM HDR	T	C	6	9	BL	7 7/8	43 1/2	C	40	A	C	271032
35	40	2 3/8	KENWORTH	W900	R	C	4	10	BL	7 7/8	43 1/2	2 1/8	40	A	C	226546
35	40	2 7/8	ADVANCE MIXER	K85 CEMENT TRUCK	R	C	5	10	BL	7 3/4	42 1/2	C	54	A	C	226327
35	40	2 7/8	KENWORTH	W900 HVY T/BTM HDRS	R	C	5	10	BH	7 7/8	43 1/2	2 13/16	40	A	C	226547
35	40	3 7/16	KENWORTH	W900 CONVENTIONAL	R	C	6	11	BL	7 7/8	43 1/2	C	40	A	C	226199
35	40	3 7/16	KENWORTH	W900	R	C	6	10	BL	7 7/8	43 1/2	2 13/16	40	A	C	226544
35	40	4 7/16	KENWORTH	K94	R	C	8	8	BL	7 7/8	43 1/2	C	40	A	C	226543
35	41	2 1/4	KENWORTH	K194-1871 CAN USE 226545	VH	C	3	16	BL	7 5/16	43 1/2	C	52	A	N	251137
35	41	3	KENWORTH		VH	C	4	16	BL	7 5/16	43 1/2	C	52	A	N	251138
35	41 1/16	3	KENWORTH	W-900 CONVENTIONAL ULTRA-FUSED CAN USE 226200	VH	C	4	16	BL	7 5/16	43 1/2	C	52	A	N	284085
35	41 1/4	2 1/4	KENWORTH		X	C	3	11	BL	7 5/16	43 1/2	C	52	A	CC	266392
35	41 1/4	2 3/8	KENWORTH	W900 CONVENTIONAL HVY BTM HDR	R	C	4	11	BL	7 5/16	43 1/2	C	52	A	CC	226545

Vista-Pro Automotive - Core Catalog
(Cores Sorted by Size)

Height	Width	Depth	Application	Description	Fin Type	Fin Matl	Rows	FPI	BH / TH Type	BH / TH Width	BH / TH Length	BH / TH OHF	BH / TH Bolts	BH / TH Shape	Hdr Support	Model #
35	41 1/4	3 7/16	KENWORTH	W900 KO94-79	R	C	6	11	BL BH	7 5/16 7 5/16	43 1/2 43 1/2	C C	52 52	A A	CC	226200
35	46	6	JOHN DEERE	862 SCRAPER HVY T/BTM HDRS BRASS FINS	B	B	8	8	BH BH	8 7/8 8 7/8	48 5/8 48 5/8	C C	58 58	A A	CC	272510
35	46 1/4	6	JOHN DEERE	SCRAPER HVY T/BTM HDRS BRASS FINS	Z	B	8	10	BH BH	8 7/8 8 7/8	48 5/8 48 5/8	C C	58 58	A A	CC	285190
35 1/16	29 3/8	2 3/8	CRANE CARRIER	HVY BTM HDR	R	C	4	9	BL BH	6 7/8 6 7/8	31 1/4 31 1/4	1 3/4 1 3/4	42 42	A A	C	226407
35 1/16	29 3/8	2 7/8	CRANE CARRIER		R	C	5	11	BL BL	10 3/8 6 7/8	31 1/4 31 1/4	2 7/16 1 3/4	54 42	F A	C	226123
35 1/16	29 3/8	3 7/16	CRANE CARRIER		R	C	6	11	BL BL	10 3/8 6 7/8	31 1/4 31 1/4	2 7/16 1 3/4	54 42	F A	C	226406
35 1/16	29 3/8	3 7/16	CRANE CARRIER	7 1/2" X 12" CRANK BOX	R	C	6	11	BL BL	10 3/8 6 7/8	31 1/4 31 1/4	2 7/16 1 3/4	54 42	F A	C	226839
35 1/8	29 3/8	2 3/8	WESTERN STAR	TEMPLATE #20	R	C	4	10	BL BL	10 3/8 6	31 1/4 31 1/4	2 7/8 C	54 42	B B	C	226790
35 1/8	29 3/8	2 7/8	AUTOCAR	5GAB-090 CAN USE 281943	R	C	5	9	BL BL	10 3/8 6	31 1/4 31 1/4	3 1 3/4	54 42	B B	C	226246
35 1/4	25	2 7/8	WARD La FRANCE		R	C	5	11	GR GR	5 7/8 4 3/8	25 7/8 25 7/8	2 1/2 C		A A	C	226779
35 1/4	28 1/8	3 7/16	KENWORTH	KCJ	R	C	6	10	BL BL	6 3/8 6 3/8	30 3/4 30 3/4	C C	42 42	A A	C	226550
35 1/4	28 1/8	3 15/16	KENWORTH		R	C	7	8	BL BL	7 5/16 7 5/16	30 5/8 30 5/8	C C	38 38	A A	C	226552
35 1/4	29 3/8	3 7/16	CRANE CARRIER	7 1/2" X 12" CRANK BOX	R	C	6	11	BL BL	10 3/8 6 7/8	31 1/4 31 1/4	2 1/4 C	46 40	A A	C	226810
35 3/8	27 1/2	1 3/4	AUTOCAR		R	C	3	11	BL BL	7 7	30 3/8 30 3/8	C C	42 42	A A	C	226280
35 3/8	27 1/2	2 7/8	AUTOCAR		R	C	5	11	BL BL	7 7	30 3/8 30 3/8	1 11/16 1 11/16	42 42	A A	C	226281
35 3/8	35	1 3/4	VOLVO WHITEGMC	ROAD BOSS 1100722	R	C	3	11	BL BL	7 7	37 7/8 37 7/8	2 7/16 2 7/16	50 50	A A	C	226744
35 3/8	35	2 3/8	VOLVO WHITEGMC	ROAD BOSS	R	C	4	11	BL BL	7 7	37 7/8 37 7/8	2 7/16 2 7/16	50 50	A A	C	226746
35 3/8	35	2 7/8	VOLVO WHITEGMC	ROAD BOSS	R	C	5	11	BL BL	7 7	37 7/8 37 7/8	2 7/16 2 7/16	50 50	A A	C	226745
35 1/2	26 1/4	3 7/16	HAHN	FIRE TRUCK HVY BTM HDR	R	C	6	11	BL BH	7 7	28 7/8 28 7/8	C C	40 40	A A	C	226509
35 1/2	28	6	LIFT TRUCKS & LOADERS	CLARK HVY T/BTM HDRS BRASS FINS FACE DIPPED	B	B	8	6	BH BH	8 3/4 8 3/4	30 3/4 30 3/4	C C	44 44	A A	C	272474
35 1/2	31 1/4	3 15/16	FORD TRACTOR	900 9702126	S	C	7	9	GR GR	4 1/2 4 1/2	31 7/16 31 7/16	C C		A A	C	229059
35 1/2	40 5/8	2 3/8	VOLVO WHITEGMC	ROAD BOSS LOW FLOW CAN USE 284771 DIMPLED TUBE	R	C	4	11	BL BL	7 7	43 3/8 43 3/8	2 13/16 2 13/16	56 56	A A	CC	226020
35 1/2	40 5/8	2 7/8	VOLVO WHITEGMC	ROAD BOSS	R	C	5	10	BL BL	7 7	43 3/8 43 3/8	2 1/2 2 1/2	56 56	A A	CC	226750
35 5/8	27 1/2	2 3/8	MACK TRUCKS	3MF-5275-P4	R	C	4	11	GR GR	6 1/2 4 7/8	28 1/4 28 1/4	2 1/2 1 3/8		A A	C	226216
35 5/8	27 1/2	2 3/8	MACK TRUCKS	MC, MR	R	C	4	11	GR GR	4 1/4 4 1/4	28 1/4 28 1/4	C C		A A	C	226591
35 5/8	27 1/2	2 7/8	MACK TRUCKS	MC, MR487	R	C	5	11	GR GR	6 1/2 4 7/8	28 1/4 28 1/4	2 1/2 1 3/8		A A	C	226217
35 5/8	27 1/2	2 7/8	MACK TRUCKS	MC, MR	R	C	5	11	GR GR	4 1/4 4 1/4	28 1/4 28 1/4	3/8 3/8		A A	C	226592
35 5/8	35	2 7/8	VOLVO TRUCK		R	C	5	11	BL BL	7 7	37 7/8 37 7/8	2 1/2 2 1/2	50 50	A A	C	226573
35 3/4	22 1/2	4 7/16	CATERPILLAR	955K, 955L HVY T/BTM HDRS BRASS FINS	Z	B	6	9	BH BH	7 3/8 7 3/8	24 1/8 24 1/8	C C	26 26	F F	C	225152
35 3/4	22 1/2	5 3/16	CATERPILLAR	955K, 955L 2P1332-HVY T/BTM HDRS BRASS FINS	Z	B	7	9	BH BH	7 3/8 7 3/8	24 1/8 24 1/8	C C	26 26	F F	C	225137
35 3/4	22 1/2	5 3/16	CATERPILLAR	955K, 955L 2P1332-HVY T/BTM HDRS HVY STEEL FINS	Z	S	7	9	BH BH	7 3/8 7 3/8	24 1/8 24 1/8	C C	26 26	F F	C	225875
35 3/4	23	5 1/4	CATERPILLAR	955L HVY T/BTM HDRS BRASS FINS FACE DIPPED	B	B	7	6	BH BH	7 3/8 7 3/8	24 1/8 24 1/8	C C	26 26	F F	C	229506

Vista-Pro Automotive - Core Catalog
(Cores Sorted by Size)

Height	Width	Depth	Application	Description	Fin Type	Fin Matl	Rows	FPI	BH / TH Type	BH / TH Width	BH / TH Length	BH / TH OHF	BH / TH Bolts	BH / TH Shape	Hdr Support	Model #
35 3/4	33 3/4	3 3/4	MANITOWOC	NORTHWEST CRANE HVY BTM HDR	T	C	5	7	BL BH	6 3/4 6 3/4	35 3/4 35 3/4	1 1/4 1 1/4	36 36	A A	C	223299
35 3/4	34 5/16	3 3/4	AJAX	11 X 15 DP-115 HVY BTM HDR	T	C	5	7	BL BH	6 3/4 6 3/4	38 38	C	34 34	J J	C	223001
35 3/4	34 5/16	3 3/4	AJAX	DP-115 HVY BTM HDR	T	C	5	7	BL BH	6 3/4 6 3/4	38 3/4 38 3/4	C	44 44	A A	C	223028
35 3/4	34 3/8	3	AJAX	11 X 15 HVY BTM HDR	X	C	4	7	BL BH	6 3/4 6 3/4	38 38	C	34 34	J J	C	274507
35 3/4	37 1/2	4 7/16	FIAT ALLIS	HD-16 HVY BTM HDR BRASS FINS	Z	B	6	7	BL BH	7 3/8 7 3/8	40 3/8 40 3/8	C	50 50	A A	C	225495
35 3/4	33 3/4	3	AJAX		X	C	4	7	BL BH	6 3/4 6 3/4	38 38	1 3/8 1 3/8	34 34	J J	C	221201
35 13/16	20 1/2	4 1/2	CASE/INTERNATIONAL	1450 CRAWLER HVY T/BTM HDRS BRASS FINS FACE DIPPED	B	B	6	7	BH BH	7 5/8 7 5/8	22 3/8 22 3/8	C	32 32	A A	C	272465
35 13/16	20 5/8	4 7/16	CASE/INTERNATIONAL	1020 N-6653 R-49975 BRASS FINS	Z	B	6	9	BL BL	7 5/8 7 5/8	22 3/8 22 3/8	C	34 34	A A	C	225012
35 7/8	40	3 7/16	AUTOCAR	HVY BTM HDR TEMPLATE #1	R	C	6	11	BL BH	10 7 1/16	45 44 3/8	2 2	60 56	I C	C	226282
35 15/16	36	4 1/2	CATERPILLAR	D342 HVY T/BTM HDRS	T	C	6	8	BH BH	8 8	39 1/2 39 1/2	C	50 50	A A	C	272604
35 15/16	36	4 1/2	CATERPILLAR	D343, D353 HVY T/BTM HDRS BRASS FINS FACE DIPPED	B	B	6	7	BH BH	8 8	39 1/2 39 1/2	C	50 50	A A	C	274988
35 15/16	36 1/4	3 3/4	CATERPILLAR	D343, D353 HVY T/BTM HDRS	X	C	5	9	BH BH	8 8	39 1/2 39 1/2	C	50 50	A A	C	266162
35 15/16	36 1/4	4 7/16	CATERPILLAR	D353 3L5102 HVY BTM HDR BRASS FINS	Z	B	6	9	BL BH	8 8	39 1/2 39 1/2	C	50 50	A A	C	225382
36	32 1/2	3 11/16	CUMMINS ENGINE	NHR HVY BTM HDR	Z	C	5	8	BL BH	8 8	37 37	1 7/8 1 7/8	48 48	A A	C	225456
36	32 1/2	4 7/16	WAUKESHA	F-817 HVY BTM HDR BRASS FINS	Z	B	6	9	BL BH	8 3/8 8 3/8	36 36	C	46 46	A A	C	288902
36	32 5/8	3 3/4	CUMMINS ENGINE	NHR HVY BTM HDR	T	C	5	8	BL BH	8 8	37 37	C	48 48	A A	C	278904
36	32 5/8	4 1/2	CUMMINS ENGINE	NHR HVY BTM HDR	T	C	6	8	BL BH	8 8	37 37	C	48 48	A A	C	277858
36	33 1/8	3	WAUKESHA	GK-145	X	C	4	7	BL BL	7 1/4 7 1/4	36 36	C	36 36	H H	C	274843
36	33 1/8	3 7/16	FORD TRACTOR	900 68720	S	C	6	9	GR GR	4 1/2 4 1/2	33 1/2 33 1/2	C		A A	C	229060
36	33 3/16	3 3/4	DETROIT DIESEL	HVY T/BTM HDRS	T	C	5	9	BH BH	8 3/8 8 3/8	36 36	C	50 50	A A	C	272877
36	33 3/16	3 3/4	WAUKESHA	GK-145	T	C	5	7	BL BL	7 1/4 7 1/4	36 36	1 3/8 1 3/8	36 36	H H	C	223300
36	33 3/4	3 3/4	WAUKESHA	HVY BTM HDR	X	C	5	8	BL BH	8 3/8 8 3/8	36 36	C	46 46	A A	C	289848
36	34 7/8	3 3/4	P & H MANUFACTURING	SHOVEL	T	C	5	8	BL BL	8 1/8 8 1/8	37 1/8 37 1/8	2 2	48 48	A A	C	272933
36	53 7/16	3 3/4	EUCLID	EUCLID HVY T/BTM HDRS	T	C	5	7	BH BH	9 1/2 9 1/2	59 59	C	62 62	A A	CC	272629
36	58 1/8	4 7/16	EUCLID	4083777 HVY T/BTM HDRS	S	C	8	9	BH BH	9 1/2 9 1/2	64 64	C	66 66	A A	CC	229045
36 1/8	25 5/16	3 3/4	DETROIT DIESEL	6V-71	T	C	5	8	BL BL	7 1/8 7 1/8	28 28	C	40 40	A A	C	270646
36 1/8	25 5/16	4 1/2	DETROIT DIESEL	TWIN DIESEL	T	C	6	8	BL BL	8 1/8 8 1/8	28 28	C	40 40	A A	C	270199
36 1/8	25 5/16	5 1/4	DETROIT DIESEL		T	C	7	7	BL SQ	8 1/8 8 1/8	28 28	C	38 38	A A	C	270093
36 1/8	25 5/8	3 3/4	DETROIT DIESEL	TWIN DIESEL	X	C	5	8	BL BL	7 1/8 7 1/8	28 28	1 13/16 1 13/16	40 40	A A	C	282153
36 1/8	30	3 7/16	FORD TRACTOR		S	C	6	8	GR GR	4 7/8 4 7/8	31 1/2 31 1/2	C		A A	C	229095
36 1/8	31 1/2	3 3/4	LIFT TRUCKS & LOADERS	HOUGH HVY BTM HDR	T	C	5	8	BL BH	8 5/8 8 5/8	34 34	C	44 44	A A	C	279718

Vista-Pro Automotive - Core Catalog
(Cores Sorted by Size)

Height	Width	Depth	Application	Description	Fin Type	Fin Matl	Rows	FPI	BH / TH Type	BH / TH Width	BH / TH Length	BH / TH OHF	BH / TH Bolts	BH / TH Shape	Hdr Support	Model #
36 1/8	32 1/2	5 3/16	CAT-LeMASTER	950E W/OC** 4W1181 GROUP REPL 7 CORES BRASS FINS O/C 441000 AVAIL	Z	B	7	7	BH BH	7 7	33 33	C C	40 40	A A	C	284144
36 1/8	33 3/16	5 1/4	CAT-LeMASTER	950E W/OC** 4W1181 GROUP REPL 7 CORES BRASS O/C 441000 AVAIL	T	B	7	7	BH BH	7 7	33 33	C C	40 40	0 0	C	274144
36 1/8	35	5 3/16	CAT-LeMASTER	627E REAR SCRAPER 7E7991, 2W0410 GROUPS REPL 7 CORES BRASS FINS	Z	B	7	7	BH BH	7 7	35 1/2 35 1/2	C C	42 42	0 0	C	284184
36 1/8	35	5 3/16	CAT-LeMASTER	637E REAR SCRAPER 4W8062 GROUP REPL 9 CORES BRASS FINS	Z	B	7	7	BH BH	7 7	35 1/2 35 1/2	C C	42 42	0 0	C	284154
36 1/4	20	4 7/16	NEW FLYER BUS	BUS; OE 6328843	R	C	8	10	BH BH	8 1/2 8 1/2	21 3/4 21 3/4	C C	32 32	A A	C	223631
36 1/4	33 1/8	2 7/8	CHEV/GMC	RTS BUS	R	C	5	9	BL BL	7 7	35 35	C C	44 44	A A	C	226379
36 1/4	33 1/8	3 7/16	CHEV/GMC	RTS BUS CAN USE 282765	R	C	6	9	BL BL	7 7	35 35	C C	44 44	A A	C	226130
36 1/4	33 1/8	3 7/16	NABI BUS		R	C	6	10	BL BL	7 7	35 35	C C	44 44	A A	C	225702
36 1/4	33 1/8	3 3/4	CHEV/GMC	BUS 2016781	X	C	5	10	BL BL	7 7	35 35	C C	44 44	A A	C	281925
36 1/4	33 1/8	3 15/16	CHEV/GMC	RTS BUS 1056463-00	R	C	7	11	BL BL	7 7	35 35	C C	44 44	A A	C	226380
36 1/4	33 1/8	4 7/16	GMC TRUCK	DETROIT DIESEL 3S41609	S	C	8	11	BL BL	7 7	35 35	C C	44 44	A A	C	229207
36 1/4	34 1/8	1 1/2	PETERBILT	SEE 251118	VTH	C	2	16	BL BL	6 1/2 6 1/2	37 1/2 37 1/2	1 9/16 1 9/16	42 42	F F	N	253118
36 1/4	34 1/8	2 1/4	PETERBILT	SEE 251118	VTH	C	3	14	BL BL	6 1/2 6 1/2	37 1/2 37 1/2	1 9/16 1 9/16	42 42	F F	N	252118
36 1/4	34 1/4	2 1/4	PETERBILT	CAN USE 226149	VH	C	3	14	BL BL	6 1/2 6 1/2	37 1/2 37 1/2	C C	42 42	F F	N	251118
36 1/4	34 3/8	1 1/2	PETERBILT	ULTRAFUSED HDRS	VH	C	2	13	BL BL	6 1/2 6 1/2	37 1/2 37 1/2	C C	42 42	0 0	N	280551
36 1/4	34 3/8	2 3/8	PETERBILT	359	R	C	4	11	BL BL	6 1/2 6 1/2	37 1/2 37 1/2	1 3/4 1 3/4	42 42	0 A	C	220038
36 1/4	34 3/8	2 3/8	PETERBILT	359 COE LOW FLOW DIMPLED TUBE	R	C	4	11	BL BL	6 1/2 6 1/2	37 1/2 37 1/2	C C	42 42	F F	C	226041
36 1/4	34 3/8	2 3/8	PETERBILT	359 CONVENTIONAL	R	C	4	11	BL BL	6 1/2 6 1/2	37 1/2 37 1/2	C C	42 42	A A	C	226149
36 1/4	34 3/8	2 7/8	PETERBILT	359 COE CAN USE 284030	R	C	5	11	BL BL	6 5/8 6 5/8	37 1/2 37 1/2	C C	42 42	F F	C	226846
36 1/4	34 3/8	2 7/8	PETERBILT	359 COE LOW FLOW DIMPLED TUBE	R	C	5	11	BL BL	6 1/2 6 1/2	37 17/32 37 17/32	C C	42 42	F F	C	226030
36 1/4	34 1/2	2 1/4	PETERBILT	359 COE LOW FLOW CAN USE 284065 DIMPLED TUBE	VH	C	3	15	BL BL	6 1/2 6 1/2	37 1/2 37 1/2	C C	42 42	F F	N	251041
36 1/4	34 1/2	3	PETERBILT	359 COE CAN USE 226846	VH	C	4	14	BL BL	6 1/2 6 1/2	37 1/2 37 1/2	C C	42 42	F F	N	251123
36 1/4	34 1/2	3	PETERBILT	359 COE LOW FLOW DIMPLED TUBE	VH	C	4	15	BL BL	6 1/2 6 1/2	37 1/2 37 1/2	C C	42 42	F F	N	251033
36 1/4	34 1/2	1 1/2	PETERBILT	SEE 251041 DIMPLED TUBE	VTH	C	2	16	BL BL	6 1/2 6 1/2	37 1/2 37 1/2	C C	42 42	F F	N	253041
36 1/4	34 1/2	2 1/4	PETERBILT	SEE 251041 DIMPLED TUBE	VTH	C	3	15	BL BL	6 1/2 6 1/2	37 1/2 37 1/2	C C	42 42	F F	N	252041
36 1/4	34 1/2	2 1/4	PETERBILT	SEE 251123	VTH	C	3	16	BL BL	6 1/2 6 1/2	37 1/2 37 1/2	C C	42 42	F F	N	253123
36 1/4	34 1/2	2 1/4	PETERBILT	SEE 251033 DIMPLED TUBE	VTH	C	3	15	BL BL	6 1/2 6 1/2	37 1/2 37 1/2	C C	42 42	F F	N	252041
36 1/4	34 1/2	3	PETERBILT	SEE 251123	VTH	C	4	14	BL BL	6 1/2 6 1/2	37 1/2 37 1/2	C C	42 42	F F	N	252123
36 1/4	34 1/2	3	PETERBILT	SEE 251033 DIMPLED TUBE	VTH	C	4	15	BL BL	6 1/2 6 1/2	37 1/2 37 1/2	C C	42 42	F F	N	252033
36 1/4	34 3/4	2 1/4	PETERBILT	362 ULTRA-FUSED LOW FLOW CAN USE 251041 DIMPLED TUBE	VH	C	3	13	BL BL	6 1/2 6 1/2	37 1/2 37 1/2	C C	42 42	F F	N	284065
36 1/4	34 3/4	2 1/4	PETERBILT	ULTRA-FUSED CAN USE 226149	VH	C	3	13	BL BL	6 1/2 6 1/2	37 1/2 37 1/2	C C	42 42	F F	N	284708

Vista-Pro Automotive - Core Catalog
(Cores Sorted by Size)

Height	Width	Depth	Application	Description	Fin Type	Fin Matl	Rows	FPI	BH / TH Type	BH / TH Width	BH / TH Length	BH / TH OHF	BH / TH Bolts	BH / TH Shape	Hdr Support	Model #
36 1/4	34 3/4	3	PETERBILT	359 COE ULTRA-FUSED CAN USE 226846	VH	C	4	13	BL BL	6 5/8 6 5/8	37 1/2 37 1/2	C C	42 42	F F	N	284030
36 1/4	34 3/4	3	PETERBILT	359 CONVENTIONAL ULTRA-FUSED LOW FLOW CAN USE 251033 DIMPLED TUBE	VH	C	4	13	BL BL	6 5/8 6 5/8	37 1/2 37 1/2	C C	42 42	F F	N	284646
36 1/4	36 1/4	3 7/16	CUMMINS/DETROIT		R	C	6	11	BL BL	7 1/8 7 1/8	39 39	C C	46 46	A A	C	226854
36 1/4	34 1/4	2 1/4	PETERBUILT		VH	C	3	14	BL BL	6 1/2 6 1/2	37 1/2 37 1/2	1 5/8 1 5/8	42 42	F F	C	251218
36 1/4	34 3/8	2 7/8	PETERBUILT		R	C	5	11	BL BL	6 1/2 6 1/2	37 1/2 37 1/2	1 1/2 1 1/2	42 42	F F	C	266846
36 1/4	34 9/16	2 1/4	PETERBUILT		VTH	C	3	14	BL BL	6 1/2 6 1/2	37 1/2 37 1/2	1 3/4 1 3/4	42 42	A A	C	252119
36 1/4	34 3/8	2 3/8	PETERBUILT		R	C	4	11	BL BL	6 1/2 6 1/2	37 1/2 37 1/2	1 9/16 1 9/16	42 42	A A	C	289990
36 1/2	28 3/4	3 11/16	TEREX	72-51 LOADER	Z	C	5	8	GR GR	4 7/8 4 7/8	29 3/4 29 3/4	C C		A A	C	286798
36 1/2	29 1/2	3	PETERBILT	WITH PTO; LOW FLOW DIMPLED TUBE	B	C	4	9	BL BH	6 6	31 1/4 31 1/4	C C	42 42	A A	C	220003
36 3/4	47 13/16	4 1/2	WABCO	VY-7099, 222G HVY T/BTM HDRS	T	C	6	8	BH BH	9 3/8 9 3/8	51 51	C C	64 64	A A	CC	272717
36 13/16	39 15/16	4 1/2	CATERPILLAR	D-7 HVY T/BTM HDRS BRASS FINS 4 CRNRS OF CORE NOTCHED	T	B	6	8	BH BH	6 9/16 6 9/16	41 1/2 41 1/2	C C	38 38	E E	C	263211
36 13/16	40	4 7/16	CATERPILLAR	D-7 9M9775 HVY T/BTM HDRS BRASS FINS 4 CRNRS OF CORE NOTCHED	Z	B	6	8	BH BH	6 9/16 6 9/16	41 1/2 41 1/2	C C	38 38	E E	F	225383
36 13/16	40	4 1/2	CATERPILLAR	D-7 HVY T/BTM HDRS BRASS FINS FACE DIPPED 4 CRNRS OF CORE NOTCHED	B	B	6	6	BH BH	6 9/16 6 9/16	41 1/2 41 1/2	C C	38 38	E E	C	274942
36 7/8	30 3/8	4 1/2	HENDRICKSON TRUCK		T	C	6	10	BL BL	7 3/4 7 3/4	32 32	1 5/8 1 5/8	46 46	A A	C	265557
37	27 1/2	2 7/8	MACK TRUCKS	WESTERN E-1462-1	R	C	5	11	BL BL	10 1/8 6	29 1/2 29 1/2	1 9/16 1 9/16	42 40	A A	C	226224
37	27 1/2	3 7/16	MACK TRUCKS	WESTERN E-1462-4 HVY BTM HDR	R	C	6	11	BL BH	10 1/8 6	29 1/2 29 1/2	1 7/16 1 7/16	42 40	A A	C	226225
37	27 1/2	3 3/4	MACK TRUCKS	WESTERN	X	C	5	11	BL BL	10 1/8 6	29 1/2 29 1/2	1 1/4 1 1/4	42 40	A A	C	289199
37	27 9/16	3	MACK TRUCKS		T	C	4	9	BL BL	10 1/4 6	29 1/2 29 1/2	1 1/8 1 1/8	42 40	A A	C	264012
37	27 9/16	3 3/4	MACK TRUCKS	HVY BTM HDR	T	C	5	9	BL BH	10 1/4 6	29 1/2 29 1/2	1 1/4 C	42 40	A A	C	275361
37	30	2 7/8	MACK TRUCKS	MODEL F HVY BTM HDR	R	C	5	11	BL BH	7 3/8 7 3/8	32 1/4 32 1/4	C C	40 40	A A	C	226310
37	31 3/8	2 1/4	FREIGHTLINER	GOLD A05-13034-002 ULTRA-FUSED CAN USE 226269 OR 251102	VH	C	3	13	BL BL	6 3/4 6 3/4	34 1/2 34 1/2	C C	40 40	F F	N	284647
37	32	1 1/2	FREIGHTLINER	SEE 251102	VTH	C	2	16	BL BL	6 3/4 6 3/4	34 1/2 34 1/2	C C	40 40	F F	N	253102
37	32	2 1/4	FREIGHTLINER	SEE 251102	VTH	C	3	14	BL BL	6 3/4 6 3/4	34 1/2 34 1/2	C C	40 40	F F	N	252102
37	32	2 1/4	FREIGHTLINER	SEE 251104	VTH	C	3	14	BL BL	6 3/4 6 3/4	34 1/2 34 1/2	C C	40 40	F F	N	253104
37	32	3	FREIGHTLINER	SEE 251104	VTH	C	4	14	BL BL	6 3/4 6 3/4	34 1/2 34 1/2	C C	40 40	F F	N	252104
37	32	2 1/4	FREIGHTLINER	GOLD A05-13034-002 CAN USE 226269	VH	C	3	14	BL BL	6 3/4 6 3/4	34 1/2 34 1/2	C C	40 40	F F	N	251102
37	32	3	FREIGHTLINER	BLUE A05-13034-004 CAN USE 226126	VH	C	4	14	BL BL	6 3/4 6 3/4	34 1/2 34 1/2	C C	40 40	F F	N	251104
37	32 7/16	1 1/2	FREIGHTLINER	SEE 251006 DIMPLED TUBE	VTH	C	2	16	BL BL	6 3/4 6 3/4	34 1/2 34 1/2	C C	40 40	F F	N	253006
37	32 7/16	2 1/4	FREIGHTLINER	SEE 251006 DIMPLED TUBE	VTH	C	3	15	BL BL	6 3/4 6 3/4	34 1/2 34 1/2	C C	40 40	F F	N	252006
37	32 7/16	2 1/4	FREIGHTLINER	SEE 251009 DIMPLED TUBE	VTH	C	3	15	BL BL	6 3/4 6 3/4	34 1/2 34 1/2	C C	40 40	F F	N	253009

Vista-Pro Automotive - Core Catalog
(Cores Sorted by Size)

Height	Width	Depth	Application	Description	Fin Type	Fin Matl	Rows	FPI	BH / TH Type	BH / TH Width	BH / TH Length	BH / TH OHF	BH / TH Bolts	BH / TH Shape	Hdr Support	Model #
37	32 7/16	3	FREIGHTLINER	SEE 251009 DIMPLED TUBE	VTH	C	4	15	BL BL	6 3/4 6 3/4	34 1/2 34 1/2	C C	40 40	F F	N	252009
37	32 1/2	2 1/4	FREIGHTLINER	ULTRA-FUSED LOW FLOW CAN USE 251006 DIMPLED TUBE	VH	C	3	14	BL BL	6 3/4 6 3/4	34 1/2 34 1/2	C C	40 40	F F	N	284631
37	32 1/2	3	FREIGHTLINER	NTC350 400 ULTA-FUSED LOW FLOW CAN USE 251009 DIMPLED TUBE	VH	C	4	14	BL BL	6 3/4 6 3/4	34 1/2 34 1/2	C C	40 40	ZZ A	N	284632
37	32 1/2	3	FREIGHTLINER	BLUE A05-13034-004 ULTRA-FUSED CAN USE 226126 OR 251104	VH	C	4	13	BL BL	6 3/4 6 3/4	34 1/2 34 1/2	C C	40 40	Z Z	N	284648
37	32 1/2	1 3/4	FREIGHTLINER	GREY CORE RD BOLT HOLES	R	C	3	11	BL BL	6 3/4 6 3/4	34 1/2 34 1/2	C C	40 40	F F	C	226468
37	32 1/2	1 3/4	FREIGHTLINER	GREY CORE A05-12122-000 HVY BTM HDR 8 OVAL BH	R	C	3	11	BL BH	6 3/4 6 3/4	34 1/2 34 1/2	1 3/4 1 3/4	38 38	F F	C	226504
37	32 1/2	2 1/4	FREIGHTLINER	LOW FLOW DIMPLED TUBE	VH	C	3	15	BL BL	6 3/4 6 3/4	34 1/2 34 1/2	C C	40 40	F F	N	251006
37	32 1/2	2 3/8	FREIGHTLINER	LOW FLOW CAN USE 284631 DIMPLED TUBE	R	C	4	11	BL BL	6 3/4 6 3/4	34 1/2 34 1/2	C C	40 40	F F	C	226014
37	32 1/2	2 3/8	FREIGHTLINER	GOLD CORE RD BOLT HOLES	R	C	4	11	BL BL	6 3/4 6 3/4	34 1/2 34 1/2	C C	40 40	F F	C	226269
37	32 1/2	2 3/8	FREIGHTLINER	GOLD CORE HVY BTM HDR 8 OVAL BH	R	C	4	11	BL BH	6 3/4 6 3/4	34 1/2 34 1/2	1 1/4 1 1/4	38 38	F F	C	226469
37	32 1/2	2 7/8	FREIGHTLINER	CUMMINS LOW FLOW CAN USE 284632 DIMPLED TUBE	R	C	5	11	BL BL	6 3/4 6 3/4	34 1/2 34 1/2	C C	40 40	F F	C	226033
37	32 1/2	2 7/8	FREIGHTLINER	BLUE CORE RD BOLT HOLES	R	C	5	11	BL BL	6 3/4 6 3/4	34 1/2 34 1/2	C C	40 40	F F	C	226126
37	32 1/2	3	FREIGHTLINER	CUMMINS LOW FLOW CAN USE 284632 DIMPLED TUBE	VH	C	4	15	BL BL	6 3/4 6 3/4	34 1/2 34 1/2	C C	40 40	F F	N	251009
37	32 1/2	3 7/16	FREIGHTLINER	BLUE CORE RD BOLT HOLES	R	C	6	11	BL BL	6 3/4 6 3/4	34 1/2 34 1/2	C C	40 40	F F	C	226470
37	32 1/2	3 7/16	FREIGHTLINER	BLUE CORE A05-10179-1 HVY BTM HDR 8 OVAL BH	R	C	6	11	BL BH	6 3/4 6 3/4	34 1/2 34 1/2	1 1/4 1 1/4	38 38	F F	C	226471
37	32 1/2	3 15/16	FREIGHTLINER	RD BOLT HOLES	R	C	7	10	BL BL	6 3/4 6 3/4	34 1/2 34 1/2	C C	40 40	F F	C	226505
37	32 1/2	3 15/16	FREIGHTLINER	HVY BTM HDR 8 OVAL BH	R	C	7	10	BL BH	6 3/4 6 3/4	34 1/2 34 1/2	C C	38 38	F F	C	226506
37	32 1/2	4 7/16	FREIGHTLINER	WHITE CORE A0510450-000 HVY BTM HDR 8 OVAL BH	R	C	8	10	BL BH	6 3/4 6 3/4	34 1/2 34 1/2	C C	38 38	F F	C	226473
37	32 5/8	3 3/4	FREIGHTLINER	HVY BTM HDR	T	C	5	11	BL BH	6 3/4 6 3/4	34 1/2 34 1/2	1 1/8 1 1/8	38 38	F F	C	265203
37	32 5/8	4 1/2	FREIGHTLINER	HVY BTM HDR	T	C	6	10	BL BH	6 3/4 6 3/4	34 1/2 34 1/2	C C	38 38	F F	C	265204
37	34 5/16	3	MASSEY-FERGUSON	HVY BTM HDR	T	C	4	8	BL BH	6 1/8 6 1/8	36 3/4 36 3/4	1 1/4 1 1/4	46 46	H H	C	272726
37	34 5/16	4 1/2	LIFT TRUCKS & LOADERS	CLARK HVY BTM HDR	T	C	6	9	BL BH	8 1/4 8 1/4	36 1/2 36 1/2	C C	46 46	A A	C	272821
37	37 1/2	5 3/16	HAPPY YOUNG	HVY BTM HDR BRASS FINNS 4 CORES PER RAD	Z	B	7	10	BL BH	8 3/4 8 3/4	39 7/8 39 7/8	C C	50 50	A A	C	288259
37 1/8	37 1/2	5 3/16	DRESSER INDUSTRIES	TD-20 HVY T/BTM HDRS BRASS FINNS	Z	B	7	6	BH BH	8 1/8 8 1/8	39 5/8 39 5/8	C C	50 50	A A	C	225643
37 1/8	39 15/16	3	NAVISTAR	4300 TRANSTAR CONVENTIONAL HVY BTM HDR	T	C	4	11	BL BH	6 11/16 6 11/16	43 1/8 43 1/8	2 1/8 2 1/8	64 64	B B	C	223303
37 1/8	40	2 3/8	NAVISTAR	4300 TRANSTAR HVY BTM HDR	R	C	4	9	BL BH	6 11/16 6 11/16	43 1/8 43 1/8	2 1/8 2 1/8	64 64	B B	C	226671
37 1/8	40	2 7/8	NAVISTAR	4300 TRANSTAR HVY BTM HDR	R	C	5	11	BL BH	6 11/16 6 11/16	43 1/8 43 1/8	2 1/8 2 1/8	64 64	B B	C	226670
37 1/8	40	3 7/16	NAVISTAR	4300 TRANSTAR HVY BTM HDR	R	C	6	11	BL BH	6 11/16 6 11/16	43 1/8 43 1/8	1 7/8 1 7/8	64 64	B B	C	226672
37 3/16	32	5 1/4	DRESSER INDUSTRIES	250-C LOADER HVY T/BTM HDRS BRASS FINNS FACE DIPPED	B	B	7	7	BH BH	9 7/16 9 7/16	34 1/4 34 1/4	1 5/8 1 5/8	46 46	A A	C	229550
37 3/16	32 1/2	2 3/8	NAVISTAR	4270 TRANSTAR	R	C	4	9	BL BL	6 11/16 6 11/16	35 1/2 35 1/2	C C	54 54	B B	C	226674

Vista-Pro Automotive - Core Catalog
(Cores Sorted by Size)

Height	Width	Depth	Application	Description	Fin Type	Fin Matl	Rows	FPI	BH / TH Type	BH / TH Width	BH / TH Length	BH / TH OHF	BH / TH Bolts	BH / TH Shape	Hdr Support	Model #
37 3/16	32 1/2	2 7/8	NAVISTAR	4270 TRANSTAR 441829-C1 HVY BTM HDR	R	C	5	11	BL	6 11/16	35 1/2	C	54	B	C	226673
					BH	6 11/16	35 1/2	C	54	B						
37 3/16	32 1/2	3	NAVISTAR	4270 TRANSTAR	VH	C	4	14	BL	6 11/16	35 1/2	C	54	B	N	251109
					BL	6 11/16	35 1/2	C	54	B						
37 3/16	32 5/8	3	NAVISTAR	4270 TRANSTAR HVY BTM HDR	T	C	4	9	BL	6 11/16	35 1/2	1 11/16	54	B	C	223302
					BH	6 11/16	35 1/2	1 11/16	54	B						
37 3/16	38 1/8	2 3/8	MACK TRUCKS	WESTERN X-1898-1	R	C	4	11	BL	6 1/2	40	C	48	A	C	226600
					BL	6 1/2	40	C	48	A						
37 3/16	38 1/8	2 7/8	MACK TRUCKS	WESTERN X-1898-2	R	C	5	11	BL	6 1/2	40	C	48	A	C	226601
					BL	6 1/2	40	C	48	A						
37 1/4	24 3/16	2	GM		VT	C	3	12	GR	3 1/2	25 3/4	1/4		A	N	124956
					GR	3 1/2	25 3/4	1/4	A							
37 1/4	24 3/16	2 5/8	GM		VT	C	4	12	GR	3 1/2	25 3/4	C		A	N	124957
					GR	3 1/2	25 3/4	C	A							
37 1/4	25 5/8	1 3/4	CHEV/GMC	BRUIN, KODIAK C/FLO	R	C	3	11	GR	3 1/2	25 3/4	7/16		A	C	226381
					GR	3 1/2	25 3/4	7/16	A							
37 1/4	25 5/8	2 3/8	CHEV/GMC	BRUIN C/FLO	R	C	4	11	GR	3 1/2	25 3/4	3/16		A	C	226118
					GR	3 1/2	25 3/4	3/16	A							
37 1/4	30 5/8	2 3/8	MACK TRUCKS		R	C	4	11	BL	6 3/8	33	C	40	A	C	226137
					BL	6 3/8	33	C	40	A						
37 1/4	30 3/4	2 1/4	MACK TRUCKS	ULTRA-FUSED CAN USE 226137 OR 251108	VH	C	3	12	BL	6 3/8	33	C	40	A	N	284697
					BL	6 3/8	33	C	40	A						
37 1/4	31	2 1/4	MACK TRUCKS	CAN USE 226137	VH	C	3	14	BL	6 3/8	33	C	40	A	N	251108
					BL	6 3/8	33	C	40	A						
37 1/4	31 1/8	1 1/2	MACK TRUCKS	SEE 251108	VTH	C	2	16	BL	6 3/8	33	C	40	A	N	253108
					BL	6 3/8	33	C	40	A						
37 1/4	31 1/8	2 1/4	MACK TRUCKS	SEE 251108	VTH	C	3	14	BL	6 3/8	33	C	40	A	N	252108
					BL	6 3/8	33	C	40	A						
37 1/4	37 1/2	4 7/16	DRESSER INDUSTRIES	TD-20C 630458C1 HVY T/BTM HDRS BRASS FINIS	Z	B	6	8	BH	9 1/2	39 5/8	1 3/4	52	A	C	286497
					BH	9 1/2	39 5/8	1 3/4	52	A						
37 1/2	28 1/8	1 3/4	FORD TRUCK	LN7000-8000 REQUIRES BRASS TANKS REPL PTR 2 3/8" THICK SIDES	R	C	3	11	GR	3	29 1/8	C		A	C	226809
					GR	3	29 1/8	C	A							
37 1/2	28 1/8	2 3/8	FORD TRUCK	LN7000-8000 LOW FLOW REPL PTR REQ BRASS TANKS DIMPLED TUBE	R	C	4	11	GR	3	29 1/4	C		A	C	226028
					GR	3	29 1/4	C	A							
37 1/2	28 1/8	2 3/8	FORD TRUCK	LN7000-8000 REPL PTR REQ BRASS TANKS	R	C	4	11	GR	3	29 1/8	C		A	C	226500
					GR	3	29 1/8	C	A							
37 1/2	28 1/8	2 7/8	PETERBILT	352 COE	R	C	5	11	BL	9 5/8	30 3/4	3 1/2	38	F	C	226261
					BL	7	30	1 1/2	36	F						
37 1/2	28 1/8	3 7/16	FREIGHTLINER	GREEN CORE A05-10417 HVY BTM HDR	R	C	6	11	BL	6 3/4	30 1/2	1 1/8	34	F	C	226157
					BH	6 3/4	30 1/2	1 1/8	34	F						
37 1/2	28 1/8	3 7/16	PETERBILT	352 COE HVY BTM HDR	R	C	6	11	BL	9 5/8	30 3/4	3 5/16	38	DD	C	226706
					BH	7	30	1 5/16	36	F						
37 1/2	28 1/8	4 7/16	FREIGHTLINER	ORANGE CORE HVY BTM HDR	R	C	8	11	BL	6 3/4	30 1/2	1 1/8	34	F	C	226507
					BH	6 3/4	30 1/2	1 1/8	34	F						
37 1/2	28 1/8	4 7/16	PETERBILT	351, 352	R	C	8	8	BL	9 5/8	30 3/4	3 5/16	38	A	C	226707
					BH	7	30	C	36	A						
37 1/2	28 1/8	4 1/2	PETERBILT	351 HALL SCOTT HVY BTM HDR	T	C	6	9	BL	9 5/8	30 3/4	1 7/8	38	A	C	271398
					BH	7	30	C	36	A						
37 1/2	28 1/8	5 3/16	PETERBILT	BRASS FINIS	Z	B	7	11	BL	12 7/8	30 3/4	3 5/8	42	H	C	286664
					SQ	8 1/2	30	C	38	A						
37 1/2	28 1/8	5 1/4	PETERBILT	HVY BTM HDR	T	C	7	8	BL	12 7/8	30 3/4	3 1/2	42	H	C	277419
					BH	8 1/2	30	C	38	A						
37 1/2	28 1/2	3	PETERBILT	ULTRA-FUSED LOW FLOW CAN USE 226019 DIMPLED TUBE	VH	C	4	16	BL	9 5/8	30 3/4	C	38	F	N	284696
					BL	7	30	1 5/16	36	F						
37 1/2	37 1/2	2 7/8	CRANE CARRIER	HVY T/BTM HDRS	R	C	5	11	BH	6 1/2	40	C	48	A	C	226409
					BH	6 1/2	40	C	48	A						
37 1/2	37 1/2	3 7/16	CRANE CARRIER	HVY BTM HDR	S	C	6	9	BL	6 1/2	40	C	48	A	C	272825
					BH	6 1/2	40	C	48	A						
37 1/2	37 1/2	4 7/16	CATERPILLAR	627, 637 SCRAPER 2P6830 HVY T/BTM HDRS BRASS FINIS	Z	B	6	9	BH	8	40	1 1/8	38	A	F	225175
					BH	8	40	1 1/8	38	A						

Vista-Pro Automotive - Core Catalog
(Cores Sorted by Size)

Height	Width	Depth	Application	Description	Fin Type	Fin Matl	Rows	FPI	BH / TH Type	BH / TH Width	BH / TH Length	BH / TH OHF	BH / TH Bolts	BH / TH Shape	Hdr Support	Model #
37 1/2	37 1/2	4 7/16	CATERPILLAR	627, 637 SCRAPER 9S3767 HVY T/BTM HDRS HVY STEEL FINS	Z	S	6	9	BH	8	40	1 1/8	38	A	F	225833
37 1/2	37 1/2	4 1/2	CATERPILLAR	D-8 HVY T/BTM HDRS BRASS FINS FACE DIPPED	B	B	6	6	BH	8	40	1 1/8	38	A	C	277353
37 1/2	37 11/16	4 1/2	CATERPILLAR	627, 637 SCRAPER HVY T/BTM HDRS HVY STEEL FINS	T	S	6	9	BH	8	40	C	38	A	C	265551
37 1/2	37 11/16	5 1/4	LIFT TRUCKS & LOADERS	TROJAN HVY T/BTM HDRS	T	C	7	9	BH	8 1/4	40	C	50	A	C	279721
37 1/2	38	3	PETERBILT	LOW FLOW DIMPLED TUBE	VH	C	4	15	BL	9 5/8	41 1/8	3 15/16	48	B	N	251020
37 1/2	38 1/8	2 7/8	PETERBILT	LOW FLOW DIMPLED TUBE	R	C	5	11	BL	9 5/8	41 1/8	3 15/16	48	B	C	226011
37 1/2	38 1/8	4 7/16	PETERBILT	359 HVY BTM HDR	R	C	8	10	BL	9 5/8	41 1/8	3 1/8	48	F	C	226709
37 1/2	38 1/8	4 7/16	PETERBILT	359 CONVENTIONAL BRASS FINS	Z	B	6	11	BL	9 5/8	41 1/8	3 5/16	48	F	C	289830
37 1/2	38 1/4	3	PETERBILT	359	T	C	4	8	BL	9 5/8	41 1/8	C	48	F	C	265003
37 1/2	38 1/4	4 1/2	PETERBILT	HVY BTM HDR	T	C	6	8	BL	9 5/8	41 1/8	3 1/4	48	F	C	223021
37 1/2	38 5/16	2 1/4	PETERBILT	SEE 251125	VTH	C	3	16	BL	9 5/8	41 1/8	3 1/2	48	B	N	253125
37 1/2	38 5/16	3	PETERBILT	SEE 251125	VTH	C	4	14	BL	9 5/8	41 1/8	3 1/2	48	B	N	252125
37 1/2	38 1/2	3	PETERBILT	359 CONVENTIONAL CAN USE 226255	VH	C	4	14	BL	9 5/8	41 1/8	3 1/2	48	B	N	251125
37 1/2	38 3/4	2 3/8	PETERBILT	359 CONVENTIONAL HVY BTM HDR	R	C	4	11	BL	9 5/8	41 1/8	3 15/16	48	F	C	226254
37 1/2	38 3/4	2 7/8	PETERBILT	359 CONVENTIONAL	R	C	5	11	BL	9 5/8	41 1/8	3 1/2	48	B	C	226255
37 1/2	38 3/4	3 7/16	PETERBILT	359 0703772	R	C	6	11	BL	9 5/8	41 1/8	3 5/16	48	F	C	226710
37 1/2	38 3/4	3 3/4	PETERBILT	359 CONVENTIONAL	X	C	5	8	BL	9 5/8	41 1/8	2 3/4	48	F	C	286450
37 1/2	38 3/4	3	PETERBILT	359 CONVENTIONAL ULTRA-FUSED CAN USE 226255	VH	C	4	14	BL	9 5/8	41 1/8	3 1/2	48	F	N	284090
37 1/2	46 1/8	2 1/4	JOY MANUFACTURING	RPS 600DB HVY T/BTM HDRS	T	C	3	8	BH	5 7/8	48 3/4	C	56	A	CC	223254
37 9/16	25	3 11/16	CASE/INTERNATIONAL	1822 A-189203	Z	C	5	6	GR	5 7/8	25 3/4	C		A	C	225015
37 9/16	25	5 3/16	CASE/INTERNATIONAL	1844 1979366-C1 BRASS FINS	Z	B	7	6	GR	5 7/8	25 3/4	C		A	C	225016
37 9/16	43	4 1/2	CATERPILLAR	D-8 HVY T/BTM HDRS BRASS FINS	B	B	6	6	BH	6 3/8	45 1/2	C	40	F	CC	229649
37 9/16	43 1/8	4 7/16	CATERPILLAR	D-8 3S6223 HVY T/BTM HDRS SGL CTR MTG BAR BRASS FINS 4 CRNRS NOTCHED	Z	B	6	9	BH	6 3/8	45 1/2	C	40	F	F	225147
37 9/16	43 5/16	3 3/4	CATERPILLAR	D-8 HVY T/BTM HDRS BRASS FINS SGL CTR MTG BAR	T	B	5	7	BH	6 3/8	45 1/2	1	40	F	F	265029
37 9/16	43 5/16	4 1/2	CATERPILLAR	D-8 HVY T/BTM HDRS BRASS FINS RVS CTR MTG BAR	T	B	6	7	BH	6 3/8	45 1/2	C	40	F	F	223247
37 9/16	43 5/16	4 1/2	CATERPILLAR	D-8 HVY T/BTM HDRS BRASS FINS	T	B	6	8	BH	6 3/8	45 1/2	C	40	F	CC	223261
37 5/8	25	2 3/8	NAVISTAR		R	C	4	11	BL	6 1/8	27 1/2	C	38	A	C	226138
37 5/8	25 1/16	2 1/4	NAVISTAR	ULTRA-FUSED CAN USE 226138	VH	C	3	16	BL	6 1/8	27 1/2	C	38	A	N	284826
37 5/8	34 3/8	3 3/4	MASSEY-FERGUSON		X	C	5	9	BL	6 1/8	36 3/4	C	46	B	C	286971
37 5/8	38 1/2	4 1/2	CATERPILLAR	D398 HVY T/BTM HDRS	B	C	6	7	BH	7 1/2	41 1/4	C	50	A	CC	277354

Vista-Pro Automotive - Core Catalog
(Cores Sorted by Size)

Height	Width	Depth	Application	Description	Fin Type	Fin Matl	Rows	FPI	BH / TH Type	BH / TH Width	BH / TH Length	BH / TH OHF	BH / TH Bolts	BH / TH Shape	Hdr Support	Model #
37 3/4	27 1/2	4 7/16	CATERPILLAR	955K 5S5991 HVY T/BTM HDRS BRASS FINS 4 CRNRS OF CORE NOTCHED	Z	B	6	9	BH BH	7 5/16 7 5/16	29 3/8 29 3/8	C C	34 34	F F	F F	225123
37 3/4	27 9/16	4 1/2	CATERPILLAR	955 HVY T/BTM HDRS BRASS FINS 4 CRNRS OF CORE NOTCHED	T	B	6	9	BH BH	7 5/16 7 5/16	29 3/8 29 3/8	C C	34 34	F F	C C	264353
37 3/4	28	4 1/2	CATERPILLAR	955 HVY T/BTM HDRS BRASS FINS FACE DIPPED 4 CRNRS OF CORE NOTCHED	B	B	6	7	BH BH	7 5/16 7 5/16	29 3/8 29 3/8	C C	34 34	F F	C C	229539
37 3/4	37 1/2	4 7/16	FIAT ALLIS	HD-16B HVY BTM HDR BRASS FINS	Z	B	6	7	BL BH	7 3/8 7 3/8	40 3/8 40 3/8	C C	50 50	A A	C C	289498
37 3/4	37 11/16	4 1/2	FIAT ALLIS	HD-16B HVY BTM HDR BRASS FINS	T	B	6	7	BL BH	7 3/8 7 3/8	40 3/8 40 3/8	C C	50 50	A A	C C	265236
37 7/8	26 15/16	2 1/4	FORD TRUCK	SEE 251034 DIMPLED TUBE	VTH	C	3	15	BL BL	10 1/4 6	31 1/4 31 1/4	1 1/2 1 1/2	56 52	XX A	N	252034
37 7/8	27 3/8	1 1/2	FORD TRUCK	L9000 ULTRA-FUSED TEMPLATE #5 CAN USE 226106 OR 251101	VH	C	2	16	BL BL	10 1/4 6	31 1/4 31 1/4	1 5/8 1 5/8	56 52	XX XX	N	284722
37 7/8	27 3/8	2 1/4	FORD TRUCK	L9000 ULTRA-FUSED TEMPLATE #5 CAN USE 251107	VH	C	3	16	BL BL	10 1/4 6	31 1/4 31 1/4	1 5/8 1 5/8	56 52	XX XX	N	284070
37 7/8	27 3/8	2 1/4	FORD TRUCK	LN9000 ULTRA-FUSED LOW FLOW TEMPLATE #5A CAN USE 251034 DIMPLED TUBE	VH	C	3	14	BL BL	10 1/4 6	31 1/4 31 1/4	1 1/2 1 1/2	56 56	XX XX	N	284688
37 7/8	27 3/8	3	FORD TRUCK	L9000 ULTRA-FUSED LOW FLOW TEMPLATE #5 CAN USE 251031 DIMPLED TUBE	VH	C	4	14	BL BL	10 1/4 6	31 1/4 31 1/4	1 5/8 1 5/8	56 52	XX XX	N	284719
37 7/8	27 3/8	1 1/2	FORD TRUCK	SEE 251107	VTH	C	2	16	BL BL	10 1/4 6	31 1/4 31 1/4	1 1/2 1 1/2	56 52	XX A	N	253107
37 7/8	27 3/8	2 1/4	FORD TRUCK	SEE 251107	VTH	C	3	14	BL BL	10 1/4 6	31 1/4 31 1/4	1 1/2 1 1/2	56 52	XX A	N	252107
37 7/8	27 1/2	1 1/2	FORD TRUCK	L9000 TEMPLATE #5 CAN USE 226106	VH	C	2	14	BL BL	10 1/4 6	31 1/4 31 1/4	1 5/8 1 5/8	56 52	XX XX	N	251101
37 7/8	27 1/2	1 3/4	FORD TRUCK	L9000 TEMPLATE #5 CAN USE 282738	R	C	3	11	BL BL	10 3/8 6	31 1/4 31 1/4	1 5/8 1 5/8	56 52	XX A	C	226106
37 7/8	27 1/2	2 1/4	FORD TRUCK	L9000 LOW FLOW TEMPLATE #5A CAN USE 284688 DIMPLED TUBE	VH	C	3	15	BL BL	10 1/4 6	31 1/4 31 1/4	1 1/2 1 1/2	56 52	XX A	N	251034
37 7/8	27 1/2	2 1/4	FORD TRUCK	L9000 TEMPLATE #5 CAN USE 226108	VH	C	3	14	BL BL	10 1/4 6	31 1/4 31 1/4	1 1/2 1 1/2	56 52	XX A	N	251107
37 7/8	27 1/2	2 3/8	FORD TRUCK	L9000 LOW FLOW TEMPLATE #5A CAN USE 284688 DIMPLED TUBE	R	C	4	11	BL BL	10 1/4 6	31 1/16 31	1 1/2 1 5/8	56 52	XX XX	C	226031
37 7/8	27 1/2	2 3/8	FORD TRUCK	L9000 TEMPLATE #5	R	C	4	11	BL BL	10 3/8 6	31 1/4 31 1/4	1 5/8 1 5/8	56 52	XX A	C	226108
37 7/8	27 1/2	2 7/8	FORD TRUCK	L9000 LOW FLOW TEMPLATE #5A CAN USE 284719 DIMPLED TUBE	R	C	5	11	BL BL	10 1/4 6	31 1/16 31 1/16	1 9/16 1 9/16	56 52	XX A	C	226027
37 7/8	27 1/2	2 7/8	FORD TRUCK	L9000 TEMPLATE #5	R	C	5	11	BL BL	10 3/8 6	31 1/4 31 1/4	1 9/16 1 9/16	56 52	XX A	C	226156
37 7/8	27 1/2	3	FORD TRUCK	L9000 LOW FLOW TEMPLATE #5A CAN USE 284719 DIMPLED TUBE	VH	C	4	15	BL BL	10 1/4 6	31 1/4 31 1/4	1 9/16 1 9/16	56 56	XX XX	N	251031
37 7/8	27 1/2	3	FORD TRUCK	L9000 TEMPLATE #5 CAN USE 226156	VH	C	4	14	BL BL	10 3/8 6	31 1/4 31 1/4	1 5/8 1 5/8	56 52	XX XX	N	251105
37 7/8	27 9/16	2 1/4	FORD TRUCK	LN9000 TEMPLATE #5	T	C	3	10	BL BL	10 1/4 6	31 1/4 31 1/4	1 5/8 1 5/8	56 52	XX XX	C	223169
37 7/8	27 9/16	3	FORD TRUCK	L9000 HVY BTM HDR TEMPLATE #5	T	C	4	10	BL BH	10 1/4 6	31 1/4 31 1/4	1 5/8 C	56 52	XX XX	C	223304
37 7/8	34 5/16	4 1/2	STEIGER TRACTOR	4 WD TRACTOR HVY BTM HDR	T	C	6	9	BL BH	7 7/8 7 7/8	36 36	C C	48 48	A A	CC	272945
38	16 1/4	5 3/16	JOHN DEERE	755 LOADER HVY T/BTM HDRS BRASS FINS END HOLES 2"	Z	B	7	9	BH BH	8 1/8 8 1/8	18 1/2 18 1/2	C C	32 32	A A	C	225633
38	16 1/4	5 3/16	JOHN DEERE	755 LOADER HVY T/BTM HDRS HVY STEEL FINS END HOLES 1 13/16"	Z	S	7	9	BH BH	8 1/8 8 1/8	18 1/2 18 1/2	C C	32 32	A A	C	225932
38	16 1/4	5 3/16	JOHN DEERE	755 LOADER HVY T/BTM HDRS HVY STEEL FINS END HOLES 2"	Z	S	7	9	BH BH	8 1/8 8 1/8	18 1/2 18 1/2	C C	32 32	A A	C	225940

Vista-Pro Automotive - Core Catalog
(Cores Sorted by Size)

Height	Width	Depth	Application	Description	Fin Type	Fin Matl	Rows	FPI	BH / TH Type	BH / TH Width	BH / TH Length	BH / TH OHF	BH / TH Bolts	BH / TH Shape	Hdr Support	Model #
38	16 5/16	5 1/4	JOHN DEERE	755 LOADER AT52690 HVY T/BTM HDRS BRASS FINNS FACE DIPPED	T	B	7	7	BH BH	8 1/4 8 1/4	17	C	24	A	C	272511
38	16 1/2	5 1/4	JOHN DEERE	655, 755 AT104825 HVY T/BTM HDRS BRASS FINNS FACE DIPPED	B	B	7	8	BH BH	8 1/8 8 1/8	18 1/2 18 1/2	C	32	A	C	272512
38	26 1/4	2 3/8	NAVISTAR	4070A TEMPLATE #13	S	C	4	10	BL BL	12 1/8 6 7/8	28 7/8 28 7/8	2 1/4 1 1/4	58	F	C	266417
38	26 1/4	2 7/8	NAVISTAR	4070A TEMPLATE #13	R	C	5	10	BL BL	12 1/8 6 7/8	28 7/8 28 7/8	2 1/4 1 3/8	58	F	C	226676
38	27 1/2	1 3/4	VOLVO WHITEGMC	ROAD BOSS HVY BTM HDR	R	C	3	11	BL BH	7 7	30 3/8 30 3/8	2 1/2 2 1/2	42	A	C	226753
38	27 1/2	2 3/8	VOLVO WHITEGMC	ROAD BOSS HVY BTM HDR	R	C	4	11	BL BH	7 7	30 3/8 30 3/8	2 1/2 2 1/2	42	A	C	226754
38	27 1/2	2 7/8	VOLVO WHITEGMC	ROAD BOSS HVY BTM HDR	R	C	5	11	BL BH	7 7	30 3/8 30 3/8	1 3/4 1 3/4	42	A	C	226751
38	27 1/2	3 7/16	VOLVO WHITEGMC	ROAD BOSS HVY BTM HDR	R	C	6	11	BL BH	7 7	30 3/8 30 3/8	1 7/8 1 7/8	42	A	C	226755
38	27 1/2	3 3/4	VOLVO TRUCK	ROAD BOSS 14" X 5" CRANK BOX OFFSET ON BH	B	C	5	10	BL BL	7 7	30 3/8 30 3/8	C	42	A	C	229652
38	27 1/2	3 3/4	VOLVO TRUCK	ROAD BOSS 14" X 5" CRANK BOX OFFSET ON BH	B	C	5	10	BL BL	7 7	30 3/8 30 3/8	C	42	A	C	229652
38	27 1/2	3 3/4	VOLVO TRUCK	ROAD BOSS 14" X 5" CRANK BOX OFFSET ON BH	B	C	5	10	BL BL	7 7	30 3/8 30 3/8	C	42	A	C	229652
38	27 1/2	3 3/4	VOLVO TRUCK	ROAD BOSS 14" X 5" CRANK BOX CTRD ON BH	B	C	5	10	BL BL	7 7	30 3/8 30 3/8	C	42	A	C	229655
38	27 1/2	3 3/4	VOLVO TRUCK	ROAD BOSS LOW FLOW 14" X 5" CRANK BOX CTRD ON BH DIMPLED TUBE	B	C	5	10	BL BL	7 7	30 3/8 30 3/8	C	42	A	C	229658
38	27 1/2	3 3/4	VOLVO TRUCK	ROAD BOSS LOW FLOW 14" X 5" CRANK BOX OFFSET ON BH DIMPLED TUBE	B	C	5	10	BL BL	7 7	30 3/8 30 3/8	C	42	A	C	229657
38	27 1/2	3 3/4	VOLVO WHITEGMC	ROAD BOSS	B	C	5	10	BL BL	7 7	30 3/8 30 3/8	C	42	A	C	260562
38	29 3/8	2 3/8	NAVISTAR	TEMPLATE #15	R	C	4	11	BL BL	10 1/4 6 7/8	31 1/4 31 1/4	2 1/8 2 1/8	54	A	C	226680
38	29 3/8	2 7/8	NAVISTAR	5000 PAYSTAR TEMPLATE #12	R	C	5	11	BL BL	10 1/4 6 7/8	31 1/4 31 1/4	2 C	54	A	C	226195
38	29 3/8	2 7/8	NAVISTAR	5000 PAYSTAR TEMPLATE #15	R	C	5	11	BL BL	10 1/4 6 7/8	31 1/4 31 1/4	1 7/8 1 7/8	54	A	C	226681
38	29 3/8	2 7/8	VOLVO WHITEGMC	ROAD BOSS HVY BTM HDR 4 CRNRS OF CORE NOTCHED	R	C	5	11	BL BH	7 7	30 3/8 30 3/8	2 1/2 2 1/2	42	A	C	226758
38	29 3/8	3 7/16	NAVISTAR	5000 PAYSTAR TEMPLATE #12	R	C	6	11	BL BL	10 1/4 6 7/8	31 1/4 31 1/4	1 1/2 1 1/2	54	A	C	226196
38	29 3/8	3 7/16	NAVISTAR	PAYSTAR TEMPLATE #15	R	C	6	11	BL BL	10 1/4 6 7/8	31 1/4 31 1/4	1 1/2 1 1/2	54	A	C	226678
38	29 3/8	3 7/16	VOLVO WHITEGMC	ROAD BOSS HVY BTM HDR 4 CRNRS OF CORE NOTCHED	R	C	6	11	BL BH	7 7	30 3/8 30 3/8	C	42	A	C	226759
38	31 1/2	3 3/4	CATERPILLAR	966 LOADER HVY T/BTM HDRS BRASS FINNS FACE DIPPED 4 CRNRS OF CORE NOTCHED	B	B	5	7	BH BH	8 1/4 8 1/4	32 13/16 32 13/16	C	32	A	C	229507
38	31 1/2	4 1/2	CATERPILLAR	966 LOADER HVY T/BTM HDRS BRASS FINNS 4 CRNRS OF CORE NOTCHED	T	B	6	9	BH BH	8 1/4 8 1/4	32 13/16 32 13/16	C	32	A	C	265022
38	31 7/8	3 11/16	CATERPILLAR	966C 1P4404 HVY T/BTM HDRS 4 CRNRS OF CORE NOTCHED	Z	C	5	9	BH BH	8 1/4 8 1/4	32 13/16 32 13/16	C	32	A	C	225113
38	31 7/8	3 11/16	CATERPILLAR	966C 1P4404 HVY T/BTM HDRS HVY STEEL FINNS 4 CRNRS OF CORE NOTCHED	Z	S	5	9	BH BH	8 1/4 8 1/4	32 13/16 32 13/16	C	32	A	C	225909
38	31 7/8	4 7/16	CATERPILLAR	966 9S4104 HVY T/BTM HDRS BRASS FINNS 4 CRNRS OF CORE NOTCHED	Z	B	6	9	BH BH	8 1/4 8 1/4	32 13/16 32 13/16	C	32	A	C	225055
38	31 7/8	4 7/16	CATERPILLAR	966 9S4104 HVY T/BTM HDRS HVY STEEL FINNS 4 CRNRS OF CORE NOTCHED	Z	S	6	9	BH BH	8 1/4 8 1/4	32 13/16 32 13/16	C	32	A	C	225863

Vista-Pro Automotive - Core Catalog
(Cores Sorted by Size)

Height	Width	Depth	Application	Description	Fin Type	Fin Matl	Rows	FPI	BH / TH Type	BH / TH Width	BH / TH Length	BH / TH OHF	BH / TH Bolts	BH / TH Shape	Hdr Support	Model #
38	31 7/8	5 3/16	CATERPILLAR	814, 815, 816 2P6111 HVY T/BTM HDRS BRASS FINS 4 CRNRS OF CORE NOTCHED	Z	B	7	9	BH BH	8 1/4 8 1/4	32 13/16 32 13/16	C	32	A	F	225219
38	32	4 1/2	CATERPILLAR	966C HVY T/BTM HDRS BRASS FINS	B	B	6	7	BH BH	8 1/4 8 1/4	32 13/16 32 13/16	C	32	A	C	229542
38	33 1/8	4 7/16	CATERPILLAR	977 3S9737 HVY T/BTM HDRS HVY STEEL FINS 4 CRNRS OF CORE NOTCHED	Z	S	6	9	BH BH	6 1/2 6 1/2	33 1/4 33 1/4	C	30	A	F	225843
38	33 3/16	4 1/2	WAUKESHA	F-2896 HVY T/BTM HDRS 4 CORES PER RAD	T	C	6	8	BH BH	7 5/8 7 5/8	35 5/8 35 5/8	C	44	A	C	272542
38	33 1/2	6	DETROIT DIESEL	DRILL ENGINE HVY T/BTM HDRS	B	C	8	6	BH BH	8 1/2 8 1/2	35 3/4 35 3/4	C	46	A	C	272869
38	33 3/4	4 1/2	STEIGER TRACTOR	HVY T/BTM HDRS	T	C	6	8	BH BH	7 7/8 7 7/8	36 36	C	48	A	C	265870
38	34 3/8	4 7/16	CATERPILLAR	HVY T/BTM HDRS BRASS FINS 4 CORES PER RAD	Z	B	6	11	BH BH	8 8	37 1/4 37 1/4	C	44	A	C	225389
38	34 3/4	2 1/4	VOLVO WHITEGMC	20001-8898 ULTRA-FUSED LOW FLOW CAN USE 251029 DIMPLED TUBE	VH	C	3	16	BL BL	7 7	37 7/8 37 7/8	1 7/8 1 7/8	50	A	N	284691
38	34 3/4	3	VOLVO WHITEGMC	20002-5059 ULTRA-FUSED LOW FLOW CAN USE 251032 DIMPLED TUBE	VH	C	4	16	BL BL	7 7	37 7/8 37 7/8	2 1/8 2 1/8	50	A	N	284690
38	34 7/8	3	VOLVO WHITEGMC	ROAD COMMANDER	T	C	4	9	BL BL	7 7	37 7/8 37 7/8	2 1/2 2 1/2	50	A	C	265601
38	34 15/16	2 1/4	VOLVO/GM LO-FLOW VH	SEE 251029 DIMPLED TUBE	VTH	C	3	15	BL BL	7 7	37 7/8 37 7/8	1 7/8 1 7/8	50	A	N	252029
38	35	1 3/4	VOLVO TRUCK	ROAD BOSS II 2 PASS HIGH FLOW W/BAFFLE HVY BTM HDR	R	C	3	11	BL BH	7 7	37 7/8 37 7/8	2 5/8 2 5/8	50	A	C	226286
38	35	1 3/4	VOLVO WHITEGMC	ROAD BOSS II 1100712 HVY BTM HDR	R	C	3	11	BL BH	7 7	37 7/8 37 7/8	2 5/8 2 5/8	50	A	C	226760
38	35	2 1/4	VOLVO/GM LO-FLOW VH	ROAD BOSS II LOW FLOW CAN USE 284691 DIMPLED TUBE	VH	C	3	15	BL BL	7 7	37 7/8 37 7/8	1 7/8 1 7/8	50	A	N	251029
38	35	2 3/8	VOLVO WHITEGMC	ROAD BOSS II LOW FLOW CAN USE 284691 DIMPLED TUBE	R	C	4	11	BL BL	7 7	37 7/8 37 7/8	1 7/8 1 7/8	50	A	C	226024
38	35	2 3/8	VOLVO WHITEGMC	ROAD BOSS II HVY BTM HDR	R	C	4	11	BL BH	7 7	37 7/8 37 7/8	2 5/8 2 5/8	50	A	C	226761
38	35	2 7/8	VOLVO WHITEGMC	ROAD BOSS II 20002-5059 LOW FLOW CAN USE 284690 DIMPLED TUBE	R	C	5	11	BL BL	7 7	37 7/8 37 7/8	2 1/8 2 1/8	50	A	C	226029
38	35	2 7/8	VOLVO WHITEGMC	ROAD BOSS II HVY BTM HDR	R	C	5	11	BL BH	7 7	37 7/8 37 7/8	2 5/8 2 5/8	50	A	C	226762
38	35	3	VOLVO/GM	ROAD BOSS II 20002-5059 LOW FLOW CAN USE 284690 DIMPLED TUBE	VH	C	4	15	BL BL	7 7	37 7/8 37 7/8	2 1/8 2 1/8	50	A	N	251032
38	35	3 7/16	VOLVO WHITEGMC	HVY BTM HDR	R	C	6	11	BL BH	7 7	37 7/8 37 7/8	1 15/16 1 15/16	50	A	C	226763
38	35 7/16	3	VOLVO WHITEGMC	HVY BTM HDR	T	C	4	11	BL BH	7 7	37 7/8 37 7/8	1 5/8 1 5/8	50	A	C	265680
38	35 5/8	2 3/8	VOLVO WHITEGMC	ROAD BOSS II HVY BTM HDR	R	C	4	11	BL BH	7 7	37 7/8 37 7/8	2 7/16 2 7/16	50	A	C	226765
38	36	3 3/4	CATERPILLAR	3406 HVY T/BTM HDRS BRASS FINS	T	B	5	8	BH BH	10 1/2 8	39 1/2 39 1/2	1 3/4 1 3/4	52	A	C	223070
38	36	5 1/4	CATERPILLAR	3408 HVY T/BTM HDRS	T	C	7	8	BH BH	10 1/2 8	39 1/2 39 1/2	1 3/4 1 3/4	52	A	C	272577
38	36 1/4	3 11/16	CATERPILLAR	3412 ENGINE 4N8191 HVY T/BTM HDRS	Z	C	5	9	BH BH	10 1/2 8	39 1/2 39 1/2	1 3/4 1 3/4	52	A	C	225549
38	36 1/4	3 11/16	CUMMINS ENGINE	GEN SET	Z	C	5	11	BL BL	8 1/4 8 1/4	38 1/4 38 1/4	1 1/2 1 1/2	46	A	C	225476
38	36 1/4	4 7/16	CATERPILLAR	8N4878 HVY BTM HDR BRASS FINS	Z	B	6	9	BH BH	10 1/2 8	39 1/2 39 1/2	1 3/4 1 3/4	52	A	C	225386
38	36 1/4	5 3/16	CATERPILLAR	HVY BTM HDR BRASS FINS	Z	B	7	8	BH BH	10 1/2 8	39 1/2 39 1/2	1 3/4 1 3/4	52	A	C	225395
38	36 9/16	4 1/2	CATERPILLAR	HVY T/BTM HDRS BRASS FINS	T	B	6	10	BH BH	10 1/2 8	39 1/2 39 1/2	1 3/4 1 3/4	52	A	C	265858
38	37 1/2	1 3/4	VOLVO WHITEGMC	ROAD BOSS II 1100712 HVY BTM HDR	R	C	3	11	BL BH	7 7	37 7/8 37 7/8	2 5/8 2 5/8	50	A	C	226766

Vista-Pro Automotive - Core Catalog
(Cores Sorted by Size)

Height	Width	Depth	Application	Description	Fin Type	Fin Matl	Rows	FPI	BH / TH Type	BH / TH Width	BH / TH Length	BH / TH OHF	BH / TH Bolts	BH / TH Shape	Hdr Support	Model #
38	37 1/2	2 3/8	VOLVO WHITEGMC	ROAD BOSS 1100713 HVY BTM HDR	R	C	4	11	BL	7	37 7/8	2 5/8	50	A	C	226768
									BH	7	37 7/8	2 5/8	50	A		
38	37 1/2	2 7/8	VOLVO WHITEGMC	ROAD BOSS 1100714 HVY BTM HDR	R	C	5	11	BL	7	37 7/8	2 5/8	50	A	C	226767
									BH	7	37 7/8	2 5/8	50	A		
38	37 1/2	3 15/16	CATERPILLAR	D398 8L5765 HVY T/BTM HDRS 4 CORES PER RAD	S	C	7	10	BH	7 3/8	40	C	48	A	C	229200
									BH	7 3/8	40	C	48	A		
38	37 1/2	4 7/16	CATERPILLAR	D398 6L2344 HVY T/BTM HDRS BRASS FINS 4 CORES PER RAD	Z	B	6	9	BH	7 3/8	40	C	48	A	C	225390
									BH	7 3/8	40	C	48	A		
38	38	4 1/2	CATERPILLAR	D398 HVY T/BTM HDRS BRASS FINS FACE DIPPED	B	B	6	6	BH	7 3/8	40	C	48	A	F	229508
									BH	7 3/8	40	C	48	A		
38	38 1/4	4 1/2	CATERPILLAR	D398 HVY T/BTM HDRS BRASS FINS	T	B	6	9	BH	7 3/8	40	C	48	A	C	223112
									BH	7 3/8	40	C	48	A		
38	38 1/4	4 1/2	CATERPILLAR	D399 STATIONARY ENGINE HVY T/BTM HDRS BRASS FINS	T	B	6	9	BH	7 1/4	40 1/4	C	50	A	C	265669
									BH	7 1/4	40 1/4	C	50	A		
38	38 1/4	4 1/2	DETROIT DIESEL	HVY BTM HDR	T	C	6	9	BL	7 3/8	40	C	48	A	C	265375
									BH	7 3/8	40	C	48	A		
38	40 5/8	2 7/8	VOLVO WHITEGMC	ROAD BOSS HVY BTM HDR	R	C	5	10	BL	7	43 3/8	2 1/2	56	A	CC	226770
									BH	7	43 3/8	2 1/2	56	A		
38 1/16	36	3	CUMMINS ENGINE	HVY T/BTM HDRS	T	C	4	8	BH	8 1/4	38 1/4	1 9/16	46	A	C	272488
									BH	8 1/4	38 1/4	1 9/16	46	A		
38 1/8	39 15/16	4 1/2	EUCLID	TS-18 SCRAPER HVY T/BTM HDRS	T	C	6	7	BH	8 1/2	45	C	54	A	C	223593
									BH	8 1/2	45	C	54	A		
38 1/4	34 7/8	4 1/2	TEREX	TS-18 SCRAPER HVY BTM HDR	T	C	6	7	BL	8 1/2	40	C	50	A	C	265593
									BH	8 1/2	40	C	50	A		
38 1/4	36 1/4	3 7/16	CUMMINS/DETROIT		R	C	6	11	BL	7 1/8	39	C	46	A	C	226858
									BL	7 1/8	39	C	46	A		
38 5/16	30	4 7/16	CATERPILLAR	1W1895 HVY T/BTM HDRS BRASS FINS	Z	B	6	9	BH	9	33 1/2	C	40	A	C	225078
									BH	9	33 1/2	C	40	A		
38 5/16	30	4 1/2	CATERPILLAR	950 HVY T/BTM HDRS BRASS FINS FACE DIPPED	B	B	6	7	BH	9	33 1/2	C	40	A	C	272792
									BH	9	33 1/2	C	40	A		
38 3/8	29 3/8	2 7/8	VOLVO WHITEGMC	ROAD COMMANDER TEMPLATE #20	R	C	5	9	BL	10 3/8	31 1/4	3	54	B	C	226771
									BL	6	31 1/4	1 3/4	42	B		
38 1/2	27 1/2	2 7/8	MACK TRUCKS	6 7/8" X 6 7/8" CRANK BOX	R	C	5	11	GR	4 7/8	28 5/16	1 1/4		A	C	226818
									GR	4 7/8	28 5/16	1 1/4		A		
38 1/2	27 1/2	2 7/8	MACK TRUCKS	6 7/8" X 6 7/8" CRANK BOX OFFSET	R	C	5	11	GR	4 7/8	28 5/16	1 1/4		A	C	226841
									GR	4 7/8	28 5/16	1 1/4		A		
38 1/2	31 1/4	2 7/8	FORD TRUCK	W9000 HVY BTM HDR TEMPLATE #4	R	C	5	11	BL	9 1/2	33	C	50	A	C	226161
									BH	6 5/8	33	C	47	B		
38 1/2	41 1/4	4 7/16	FIAT ALLIS	HD-21 HVY T/BTM HDRS BRASS FINS	Z	B	6	11	BH	8	44 1/2	1 5/8	56	A	CC	225518
									BH	8	44 1/2	1 5/8	56	A		
38 1/2	41 1/2	4 1/2	FIAT ALLIS	HD-21 HVY T/BTM HDRS BRASS FINS FACE DIPPED	B	B	6	6	BH	8	44 1/2	C	56	A	CC	274202
									BH	8	44 1/2	C	56	A		
38 9/16	26 7/8	2 3/8	VOLVO TRUCK	WG64T 5/8 RADIUS	R	C	4	11	GR	3 7/16	27	C		A	C	226483
									GR	3 7/16	27	C		A		
38 5/8	34 3/16	2 1/4	MACK TRUCKS	MH, RW ULTRA-FUSED LOW FLOW CAN USE 226005 DIMPLED TUBE	VH	C	3	14	BL	6 1/4	36 3/8	1 5/8	46	A	N	284629
									BL	6 1/4	36 3/8	1 5/8	46	A		
38 5/8	34 3/16	3	MACK TRUCKS	MH, RW ULTRA-FUSED LOW FLOW CAN USE 251019 DIMPLED TUBE	VH	C	4	14	BL	6 1/4	36 3/8	C	46	A	N	284628
									BL	6 1/4	36 3/8	C	46	A		
38 5/8	34 3/16	3	MACK TRUCKS	ULTRA-FUSED CAN USE 226251	VH	C	4	16	BL	6 1/4	36 3/8	C	46	A	N	284724
									BL	6 1/4	36 3/8	C	46	A		
38 5/8	34 3/8	1 3/4	MACK TRUCKS	CRUISELINER 3MF-5457-P6, E1919-2	R	C	3	11	BL	6 1/4	36 3/8	2 1/4	46	A	C	226250
									BL	6 1/4	36 3/8	2 1/4	46	A		
38 5/8	34 3/8	1 3/4	MACK TRUCKS	ULTRA-FUSED CAN USE 226250 OR 251115	R	C	3	11	BL	6 1/4	36 3/8	2 1/4	46	A	C	282126
									BL	6 1/4	36 3/8	2 1/4	46	A		
38 5/8	34 3/8	2 3/8	MACK TRUCKS	MH, RW LOW FLOW CAN USE 284629 DIMPLED TUBE	R	C	4	11	BL	6 1/4	36 3/8	1 5/8	46	A	C	226005
									BL	6 1/4	36 3/8	1 5/8	46	A		
38 5/8	34 3/8	2 3/8	MACK TRUCKS	CRUISELINER E-1919-1	R	C	4	11	BL	6 1/4	36 3/8	1 3/4	46	A	C	226249
									BL	6 1/4	36 3/8	1 3/4	46	A		
38 5/8	34 3/8	2 3/8	MACK TRUCKS	CRUISE LINER ULTRA-FUSED CAN USE 226249 OR 251115	R	C	4	11	BL	6 1/4	36 3/8	1 3/4	46	A	C	282125
									BL	6 1/4	36 3/8	1 3/4	46	A		

Vista-Pro Automotive - Core Catalog
(Cores Sorted by Size)

Height	Width	Depth	Application	Description	Fin Type	Fin Matl	Rows	FPI	BH / TH Type	BH / TH Width	BH / TH Length	BH / TH OHF	BH / TH Bolts	BH / TH Shape	Hdr Support	Model #
38 5/8	34 3/8	2 7/8	MACK TRUCKS	MH, RW LOW FLOW DIMPLED TUBE	R	C	5	11	BL BL	6 1/4 6 1/4	36 3/8 36 3/8	C C	46 46	A A	C	226009
38 5/8	34 3/8	2 7/8	MACK TRUCKS	CRUISELINER E-1919-5	R	C	5	11	BL BL	6 1/4 6 1/4	36 3/8 36 3/8	1 11/16 1 11/16	46 46	A A	C	226251
38 5/8	34 1/2	2 1/4	MACK TRUCKS	CRUISE LINER CAN USE 226249	VH	C	3	14	BL BL	6 1/4 6 1/4	36 3/8 36 3/8	1 3/4 1 3/4	46 46	A A	N	251115
38 5/8	34 1/2	3	MACK TRUCKS	MH, RW LOW FLOW DIMPLED TUBE	VH	C	4	15	BL BL	6 1/4 6 1/4	36 3/8 36 3/8	C C	46 46	A A	N	251019
38 3/4	28 3/4	5 3/16	FORD TRACTOR	609321 BRASS FINS	Z	B	7	6	GR GR	5 7/8 5 7/8	29 1/2 29 1/2	C C		A A	C	225489
38 7/8	14 3/8	3 15/16	FLXIBLE BUS		R	C	7	10	BL BL	6 1/4 6 1/4	15 7/8 15 7/8	C FF	22 22	0 A	C	221276
38 7/8	14 3/8	3 15/16	NABI BUS		R	C	7	10	BL BL	6 1/4 6 1/4	15 13/16 15 13/16	C C	22 22	A A	C	225704
38 7/8	15 5/8	3 15/16	FLXIBLE BUS		R	C	7	10	BL BL	7 7	17 5/8 17 5/8	C FF	26 26	A A	C	221277
38 7/8	15 5/8	3 15/16	NABI BUS		R	C	7	11	BL BL	7 7	17 5/8 17 5/8	C C	26 26	A A	C	225703
38 7/8	34 7/8	4 1/2	CATERPILLAR	D398 HVY T/BTM HDRS 4 CORES PER RAD	T	C	6	8	BH BH	7 1/2 7 1/2	37 1/4 37 1/4	C C	48 48	A A	C	223113
39	15 5/8	4 7/16	FLXIBLE BUS		R	C	8	11	BL BL	7 7	17 5/8 17 5/8	C C	26 26	A A	C	226866
39	26 7/8	2 3/8	MACK TRUCKS	WITH PTO BOX	R	C	4	11	BL BL	6 3/8 6 3/8	28 7/8 28 7/8	2 1/4 2 1/4	38 38	A A	C	286828
39	26 7/8	2 7/8	MACK TRUCKS	6 7/8" X 6 7/8" CRANK BOX	R	C	5	11	BL BL	6 3/8 6 3/8	28 7/8 28 7/8	2 1/8 2 1/8	34 34	A A	C	226812
39	27 1/2	2 3/8	MACK TRUCKS	F MODEL	R	C	4	11	GR GR	4 1/4 4 1/4	28 1/4 28 1/4	C C		A A	C	226226
39	29 13/16	6	CATERPILLAR	621 HVY T/BTM HDRS BRASS FINS	T	B	8	9	BH BH	8 8	32 32	C C	34 34	F F	C	264386
39	30	6	CATERPILLAR	621 5S602 HVY T/BTM HDRS BRASS FINS	Z	B	8	8	BH BH	8 8	32 32	C C	34 34	F F	F	225044
39	34 3/8	2 15/16	KOMATSU	AC300 HVY STEEL FINS	Z	S	4	9	GR GR	5 5	34 3/4 34 3/4	3/16 3/16		A A	C	225951
39	35 5/8	4 7/16	AJAX	DP-160 HVY T/BTM HDRS BRASS FINS	Z	B	6	9	BH BH	7 1/2 7 1/2	39 39	C C	48 48	A A	C	225263
39	45	5 3/16	CATERPILLAR	769B 2P1234 HVY T/BTM HDRS BRASS FINS	Z	B	7	9	BH BH	8 8	47 7/16 47 7/16	C C	46 46	F F	CC	225080
39	45	5 3/16	CATERPILLAR	769B 2P1234 HVY T/BTM HDRS HVY STEEL FINS	Z	S	7	9	BH BH	8 8	47 7/16 47 7/16	C C	46 46	F F	F	225823
39	59 5/8	4 1/2	CATERPILLAR	HVY T/BTM HDRS	T	C	6	8	BH BH	7 1/2 7 1/2	61 3/4 61 3/4	C C	72 72	A A	CC	272793
39 1/16	37 1/2	6	CATERPILLAR	631B SCRAPER 1S250 HVY T/BTM HDRS BRASS FINS	Z	B	8	8	BH BH	8 8	40 40	C C	38 38	F F	C	225068
39 1/16	38	6	CATERPILLAR	631 HVY T/BTM HDRS BRASS FINS FACE DIPPED	B	B	8	7	BH BH	8 8	40 40	C C	38 38	F F	C	275439
39 1/8	33 3/4	3 3/4	DETROIT DIESEL	HVY T/BTM HDRS	T	C	5	9	BH BH	8 8	35 35	C C	46 46	A A	C	272876
39 1/8	36 9/16	3	WESTERN STAR	TEMPLATE #19	T	C	4	10	BL BL	12 1/2 6 5/8	37 7/8 37 7/8	1 7/8 C	52 46	A A	C	265452
39 1/8	36 7/8	2 7/8	WESTERN STAR	4 CRNRS OF CORE NOTCHED	R	C	5	9	BL BL	7 6 5/8	37 15/16 37 15/16	2 1/8 1 7/8	46 46	A A	C	226792
39 3/16	31 7/8	5 3/16	CAT-LeMASTER	966D W/OC** & 815B, 816C 2W7934 & 7W2793 GROUPS REPL 10 CORES BRASS FINS 441001 O/C AVAIL	Z	B	7	7	BH BH	7 7	32 32	C C	40 40	0 0	C	284146
39 3/16	31 7/8	5 3/16	CAT-LeMASTER	966E W/OC** & 816B 2W7919 GROUP REPL 8 CORES BRASS FINS 441001 O/C AVAIL	Z	B	7	7	BH BH	7 7	32 32	C C	40 40	0 0	C	284192
39 3/16	31 7/8	5 3/16	CAT-LeMASTER	D-6H W/OC** 7C8900 GROUP REPL 7 CORES BRASS FINS 441001 O/C AVAIL	Z	B	7	7	BH BH	7 7	32 32	C C	40 40	0 0	C	284122
39 3/16	31 7/8	5 3/16	CAT-LeMASTER	D-6H (IMRM) W/OC 7E9509 REPL 8 CORES BRASS FINS 441001 O/C AVAIL	Z	B	7	7	BH BH	7 7	32 32	C C	40 40	0 0	C	284254

Vista-Pro Automotive - Core Catalog
(Cores Sorted by Size)

Height	Width	Depth	Application	Description	Fin Type	Fin Matl	Rows	FPI	BH / TH Type	BH / TH Width	BH / TH Length	BH / TH OHF	BH / TH Bolts	BH / TH Shape	Hdr Support	Model #	
39	3/16	32 1/16	5 1/4	CAT-LeMASTER	966E W/OC** & 816B 2W7919 GROUP REPL 8 CORES BRASS 441001 O/C AVAIL	T	B	7	7	BH	7	32	C	40	0	C	274192
39	3/16	32 1/16	5 1/4	CAT-LeMASTER	D-6H W/OC** 7C8900 GROUP REPL 7 CORES BRASS 441001 O/C AVAIL	T	B	7	7	BH	7	32	C	40	0	C	274122
39	3/16	36 7/8	5 3/16	CAT-LeMASTER	D-8N (IMRM) REPL 8 CORES BRASS FINS	Z	B	7	9	BH	7	37	C	44	0	C	284130
39	3/16	36 7/8	5 3/16	CAT-LeMASTER	D-6H (IMRM) 7C6564 GROUP REPL 6 CORES BRASS FINS	Z	B	7	9	BH	7	37	C	44	0	C	284142
39	3/16	36 7/8	5 3/16	CAT-LeMASTER	D-6H W/AC 1W0039 REPL 12 CORES BRASS FINS	Z	B	7	7	BH	7	37	C	44	0	C	284220
39	3/16	36 7/8	5 3/16	CAT-LeMASTER	D-6H, D-7G, D-8N 9Y3165, 2W3530, 7W0149 GROUPS REPLACES 8 & 10 COOLING SECTIONS BRASS FINS	Z	B	7	7	BH	7	37	C	44	A	C	284194
39	3/16	36 7/8	5 3/16	CAT-LeMASTER	D-8N W/AC 4W9888 REPL 12 CORES BRASS FINS	Z	B	7	7	BH	7	37	C	44	0	C	284180
39	3/16	37 1/8	5 1/4	CAT-LeMASTER	D-8N (IMRM) REPL 8 CORES BRASS FINS	T	B	7	9	BH	7	37	C	44	0	C	274130
39	3/16	37 1/8	5 1/4	CAT-LeMASTER	D-6H W/AC 1W0039 REPL 12 CORES BRASS FINS	T	B	7	7	BH	7	37	C	44	0	C	274220
39	3/16	37 1/8	5 1/4	CAT-LeMASTER	D-6H, D-7G, D-8N 9Y3165, 2W3530, 7W0149 GROUPS REPL 8 & 10 CORES BRASS FINS	T	B	7	7	BH	7	37	C	44	0	C	274194
39	3/16	37 1/8	5 1/4	CAT-LeMASTER	D-8N W/AC 4W9888 REPL 12 CORES BRASS FINS	T	B	7	7	BH	7	37	C	44	0	C	274180
39	3/16	37 1/2	5 3/16	CAT-LeMASTER	D-7G REPL 12 CORES BRASS FINS	Z	B	7	7	BH	7	38	C	44	0	C	284274
39	3/16	38 1/8	5 3/16	CAT-LeMASTER	627E, 637E FRONT 4W8495 REPL 10 CORES BRASS FINS	Z	B	7	7	BH	7	38 1/2	C	46	A	C	284156
39	3/16	39 15/16	5 1/4	CAT-LeMASTER	627E, 637E FRONT 4W8495 REPL 10 CORES BRASS FINS	T	B	7	7	BH	7	38 1/2	C	46	0	CC	274156
39	3/16	42 1/2	5 3/16	CAT-LeMASTER	3408 GEN SET REPL 9 CORES BRASS FINS	Z	B	7	7	BH	7	41	C	48	0	CC	284268
39	3/16	44 3/8	5 3/16	CAT-LeMASTER	826G w/IMRM REPL 9 CORES BRASS FINS	Z	B	7	7	BH	7	44 1/2	C	54	0	CC	284200
39	1/4	22 1/2	6	LIFT TRUCKS & LOADERS	HOUGH 550 LOADER HVY BTM HDR	T	C	8	9	BL	9 1/4	22 7/8	C	36	A	C	223588
39	1/4	29 1/2	3	PETERBILT	LOW FLOW, WITH PTO BOX DIMPLED TUBE	B	C	4	9	BL	6	31 1/4	C	42	A	C	220001
39	1/4	29 13/16	4 1/2	KENWORTH	HVY BTM HDR 1ST TO 3RD HOLE 2 3/8"	T	C	6	9	BL	7 5/16	32 1/8	C	42	A	C	223307
39	1/4	30	2 3/8	KENWORTH	K100 COE, W900 CONVENTIONAL	R	C	4	11	BL	7 3/8	32 1/8	2	42	A	C	226555
39	1/4	30	2 7/8	KENWORTH	923, 1400	R	C	5	11	BL	7 3/8	32 1/8	1 1/2	42	A	C	226201
39	1/4	30	3 7/16	KENWORTH	K100 COE, W900 CONVENTIONAL	R	C	6	11	BL	7 3/8	32 1/8	1 1/2	42	A	C	226553
39	1/4	30	3 15/16	KENWORTH	923	R	C	7	11	BL	7 3/8	32 1/8	C	42	A	C	226556
39	1/4	30	4 7/16	KENWORTH	K923, 1200	R	C	8	9	BL	7 3/8	32 1/8	C	42	A	C	226554
39	1/4	32 5/8	4 1/2	DETROIT DIESEL	8V-71 HVY BTM HDR	T	C	6	9	BL	7 1/4	35	C	46	A	C	272845
39	1/4	33 3/4	3	DETROIT DIESEL	8V-71 HVY BTM HDR 7/8" BTWN HOLES 4 & 5	T	C	4	9	BL	7 3/8	37 1/2	C	46	B	C	223601
39	1/4	33 3/4	3 3/4	DETROIT DIESEL	HVY BTM HDR 1 3/4" BTWN HOLES 4 & 5	T	C	5	9	BL	7 3/8	37 1/2	C	46	B	C	223600
39	1/4	33 3/4	3 3/4	DETROIT DIESEL	8V-71 HVY BTM HDR 2" BTWN HOLES 4 & 5	T	C	5	8	BL	7 3/8	37 1/2	C	46	B	C	223610
39	1/4	33 3/4	3 3/4	DETROIT DIESEL	8V-71 HVY BTM HDR 7/8" BTWN HOLES 4 & 5	T	C	5	9	BL	7 5/16	37 1/2	C	46	B	C	223618

Vista-Pro Automotive - Core Catalog
(Cores Sorted by Size)

Height	Width	Depth	Application	Description	Fin Type	Fin Matl	Rows	FPI	BH/TH Type	BH/TH Width	BH/TH Length	BH/TH OHF	BH/TH Bolts	BH/TH Shape	Hdr Support	Model #
39 1/4	33 3/4	4 1/2	DETROIT DIESEL	8V-71 HVY BTM HDR 7/8" BTWN HOLES 4 & 5	T	C	6	8	BL BH	7 5/16 7 5/16	37 9/16 37 9/16	C C	46 46	B B	C C	223118
39 1/4	36	4 1/2	DETROIT DIESEL	HVY T/BTM HDRS	T	C	6	8	BH BH	7 3/8 7 3/8	39 1/4 39 1/4	C C	52 52	A A	C C	272648
39 1/4	36 7/8	2 7/8	WESTERN STAR	TEMPLATE #19 4 CRNRS OF CORE NOTCHED	R	C	5	10	BL BL	12 1/2 6 5/8	37 7/8 37 7/8	1 7/8 C	52 46	A B	C C	226793
39 1/4	36 7/8	2 7/8	WESTERN STAR	TEMPLATE #19 4 CRNRS OF CORE NOTCHED	R	C	5	9	BL BL	12 1/2 6 5/8	37 7/8 37 7/8	1 7/8 C	52 46	A A	C C	226794
39 1/4	39 3/8	3 7/16	BLUE BIRD BUS		R	C	6	11	BL BL	6 7/8 6 7/8	41 1/4 41 1/4	C C	50 50	A A	C C	226297
39 5/16	38 13/16	2 1/4	QUINCY COMPRESSOR	HVY T/BTM HDRS	T	C	3	9	BH BH	6 6	41 41	C C	48 48	A A	C C	272737
39 3/8	33 3/4	3 11/16	DETROIT DIESEL	6-110 HVY BTM HDR 7/8" BTWN HOLES 4 & 5	Z	C	5	10	BL BH	7 3/8 7 3/8	37 1/2 37 1/2	1 1/2 1 1/2	46 46	B B	C C	225514
39 3/8	33 3/4	4 5/8	DETROIT DIESEL	HVY BTM HDR	X	C	6	9	BL BH	7 3/8 7 3/8	37 1/2 37 1/2	C C	46 46	B B	C C	221516
39 3/8	38 3/4	2 3/8	INGERSOLL-RAND	HVY BTM HDR	R	C	4	8	BL BH	6 6	41 41	C C	48 48	A A	C C	226516
39 7/16	22 1/2	6	CATERPILLAR	980B 7N4995 HVY T/BTM HDRS BRASS FIN 4 CRNRS OF CORE NOTCHED	Z	B	8	9	BH BH	8 8	23 1/8 23 1/8	C C	24 24	F F	C C	225082
39 7/16	22 1/2	6	CATERPILLAR	980B 9S5149 HVY T/BTM HDRS HVY STEEL FIN 4 CRNRS OF CORE NOTCHED	Z	S	8	9	BH BH	8 8	23 1/8 23 1/8	C C	24 24	F F	F F	225812
39 7/16	22 1/2	6	CATERPILLAR	980B LOADER HVY T/BTM HDRS BRASS FIN 4 CRNRS OF CORE NOTCHED	B	B	8	7	BH BH	8 8	23 23	C C	24 24	A A	C C	277135
39 1/2	27 1/2	2 3/8	CHEV/GMC	ASTRO HVY BTM HDR	R	C	4	11	BL BH	7 1/8 5 3/8	30 1/2 30 1/2	C C	46 42	A A	C C	226121
39 1/2	27 1/2	2 3/8	CHEV/GMC	ASTRO TEMPLATE # 7	R	C	4	11	BL BL	10 3/8 6 1/4	29 5/8 29 5/8	1 5/8 1 3/8	44 40	A A	C C	226382
39 1/2	27 1/2	2 7/8	CHEV/GMC	ASTRO 9500 TEMPLATE # 8	R	C	5	10	BL BL	10 3/8 6 1/4	29 5/8 29 5/8	1 1/2 1 1/2	44 40	A A	C C	226120
39 1/2	27 1/2	2 7/8	CHEV/GMC	ASTRO TEMPLATE #10	R	C	5	10	BL BL	10 3/8 6 1/4	29 5/8 29 5/8	1 1/2 1 1/2	44 40	A A	C C	226331
39 1/2	27 1/2	2 7/8	CHEV/GMC	ASTRO TEMPLATE #7	R	C	5	11	BL BL	10 3/8 6 1/4	29 5/8 29 5/8	1 5/8 1 3/8	44 40	A A	C C	226383
39 1/2	27 9/16	3	CHEV/GMC	ASTRO 9500 TEMPLATE #8	T	C	4	10	BL BL	10 3/8 6 1/4	29 5/8 29 5/8	1 1/2 1 1/2	44 40	A A	C C	265192
39 1/2	33 3/4	4 7/16	DETROIT DIESEL	8V-71 DIESEL HVY BTM HDR BRASS FIN 2" BTWN HOLES 4 & 5	Z	B	6	7	BL BH	7 1/2 7 1/2	37 1/2 37 1/2	1 1/2 1 1/2	46 46	B B	C C	225524
39 1/2	33 3/4	4 1/2	DETROIT DIESEL	6-110 HVY BTM HDR 2" BTWN HOLES 4 & 5	T	C	6	8	BL BH	7 1/2 7 1/2	37 1/2 37 1/2	C C	46 46	B B	C C	223617
39 5/8	38 1/8	1 3/4	MACK TRUCKS	WESTERN SUPERLINER E-1739	R	C	3	11	BL BL	6 1/2 6 1/2	40 40	C C	48 48	A A	C C	226228
39 5/8	38 1/8	2 3/8	MACK TRUCKS	SUPERLINER E-1739-1	R	C	4	11	BL BL	6 1/2 6 1/2	40 40	C C	48 48	A A	C C	226229
39 5/8	38 1/8	2 7/8	MACK TRUCKS	SUPERLINER E-1739-2	R	C	5	11	BL BL	6 1/2 6 1/2	40 40	C C	48 48	A A	C C	226603
39 5/8	38 1/8	3 7/16	MACK TRUCKS	SUPERLINER E-1739-3	R	C	6	11	BL BL	6 1/2 6 1/2	40 40	C C	48 48	A A	C C	226230
39 5/8	41 1/4	6	DRESSER INDUSTRIES	TD-25C HVY T/BTM HDRS HVY STEEL FIN 7/8" BTWN HOLES 5 & 6	Z	S	8	8	BH BH	9 3/8 9 3/8	44 1/2 44 1/2	1 9/16 1 9/16	66 66	A A	CC CC	225921
39 5/8	41 1/2	6	DRESSER INDUSTRIES	TD-25C CRAWLER HVY T/BTM HDRS 7/8" BTWN HOLES 5 & 6	B	C	8	7	BH BH	9 3/8 9 3/8	44 1/2 44 1/2	C C	66 66	A A	CC CC	279334
39 5/8	41 7/8	6	DRESSER INDUSTRIES	TD-25C 630463-C2 HVY T/BTM HDRS BRASS FIN	Z	B	8	9	BH BH	9 3/8 9 3/8	44 1/2 44 1/2	C C	66 66	A A	CC CC	225218
39 5/8	41 7/8	6	DRESSER INDUSTRIES	TD-25C 630463-C2 HVY T/BTM HDRS HVY STEEL FIN	Z	S	8	9	BH BH	9 3/8 9 3/8	44 1/2 44 1/2	C C	66 66	A A	CC CC	225813
39 3/4	29 3/8	3 7/16	OSHKOSH TRUCK	X-4839-1 9 3/4 X 4 3/8 CRANK BOX CTRD ON BH	R	C	6	11	BL BL	8 1/4 8 1/4	32 1/8 32 1/8	C C	40 40	A A	C C	226896
39 3/4	29 13/16	2 1/4	NAVISTAR	F2275 HVY BTM HDR	T	C	3	11	BL BH	6 3/4 6 3/4	32 1/8 32 1/8	1 3/4 1 3/4	38 38	A A	C C	265588

Vista-Pro Automotive - Core Catalog
(Cores Sorted by Size)

Height	Width	Depth	Application	Description	Fin Type	Fin Matl	Rows	FPI	BH / TH Type	BH / TH Width	BH / TH Length	BH / TH OHF	BH / TH Bolts	BH / TH Shape	Hdr Support	Model #
39 3/4	29 7/8	1 1/2	NAVISTAR	SEE 251112	VTH	C	2	16	BL	6 3/4	32 1/8	1 3/4	38	A	N	253112
										6 3/4	32 1/8	1 3/4	38	A		
39 3/4	29 7/8	1 1/2	NAVISTAR	SEE 251035 DIMPLED TUBE	VTH	C	2	16	BL	6 3/4	32 1/8	1 3/4	38	A	N	253035
										6 3/4	32 1/8	1 3/4	38	A		
39 3/4	29 7/8	2 1/4	NAVISTAR	SEE 251112	VTH	C	3	14	BL	6 3/4	32 1/8	1 3/4	38	A	N	252112
										6 3/4	32 1/8	1 3/4	38	A		
39 3/4	29 7/8	2 1/4	NAVISTAR	SEE 251035 DIMPLED TUBE	VTH	C	3	15	BL	6 3/4	32 1/8	1 3/4	38	A	N	252035
										6 3/4	32 1/8	1 3/4	38	A		
39 3/4	29 7/8	2 1/4	NAVISTAR	SEE 251116	VTH	C	3	14	BL	6 3/4	32 1/8	1 3/4	38	A	N	253116
										6 3/4	32 1/8	1 3/4	38	A		
39 3/4	29 7/8	2 1/4	NAVISTAR	SEE 251024 DIMPLED TUBE	VTH	C	3	15	BL	6 3/4	32 1/8	C	38	A	N	252035
										6 3/4	32 1/8	C	38	A		
39 3/4	29 7/8	3	NAVISTAR	SEE 251116	VTH	C	4	14	BL	6 3/4	32 1/8	1 3/4	38	A	N	252116
										6 3/4	32 1/8	1 3/4	38	A		
39 3/4	29 7/8	3	NAVISTAR	SEE 251024 DIMPLED TUBE	VTH	C	4	15	BL	6 3/4	32 1/8	C	38	A	N	252024
										6 3/4	32 1/8	C	38	A		
39 3/4	30	1 1/2	NAVISTAR	S SERIES	VH	C	2	14	BL	6 3/4	32 1/8	1 3/4	38	A	N	251114
										6 3/4	32 1/8	1 3/4	38	A		
39 3/4	30	2 1/4	NAVISTAR	S SERIES CAN USE 226140	VH	C	3	14	BL	6 3/4	32 1/8	1 3/4	38	A	N	251112
										6 3/4	32 1/8	1 3/4	38	A		
39 3/4	30	2 1/4	NAVISTAR	S SERIES LOW FLOW CAN USE 284015 DIMPLED TUBE	VH	C	3	15	BL	6 3/4	32 1/8	1 3/4	38	A	N	251035
										6 3/4	32 1/8	1 3/4	38	A		
39 3/4	30	2 3/8	NAVISTAR	S SERIES LOW FLOW CAN USE 284015 DIMPLED TUBE	R	C	4	11	BL	6 3/4	32 1/4	1 11/16	38	A	C	226034
										6 3/4	32 1/4	1 11/16	38	A		
39 3/4	30	2 3/8	NAVISTAR	S SERIES	R	C	4	11	BL	6 3/4	32 1/8	1 3/4	38	A	C	226140
										6 3/4	32 1/8	1 3/4	38	A		
39 3/4	30	2 7/8	NAVISTAR	S SERIES LOW FLOW CAN USE 284078 DIMPLED TUBE	R	C	5	11	BL	6 3/4	32 1/8	C	38	A	C	226017
										6 3/4	32 1/8	C	38	A		
39 3/4	30	2 7/8	NAVISTAR	S SERIES	R	C	5	11	BL	6 3/4	32 1/8	1 5/8	38	A	C	226142
										6 3/4	32 1/8	1 5/8	38	A		
39 3/4	30	3	NAVISTAR	S SERIES CAN USE 226142	VH	C	4	14	BL	6 3/4	32 1/8	1 3/4	38	A	N	251116
										6 3/4	32 1/8	1 3/4	38	A		
39 3/4	30	3	NAVISTAR	S SERIES LOW FLOW CAN USE 284078 DIMPLED TUBE	VH	C	4	15	BL	6 3/4	32 1/8	C	38	A	N	251024
										6 3/4	32 1/8	C	38	A		
39 3/4	30 3/16	2 1/4	NAVISTAR	S SERIES ULTRA-FUSED LOW FLOW CAN USE 251035 DIMPLED TUBE	VH	C	3	14	BL	6 3/4	32 1/8	1 3/4	38	A	N	284015
										6 3/4	32 1/8	1 3/4	38	A		
39 3/4	30 3/16	2 1/4	NAVISTAR	S SERIES ULTRA-FUSED CAN USE 226140 OR 251112	VH	C	3	14	BL	6 3/4	32 1/8	1 3/4	38	A	N	284804
										6 3/4	32 1/8	1 3/4	38	A		
39 3/4	30 3/16	3	NAVISTAR	S SERIES ULTRA-FUSED LOW FLOW CAN USE 251024 DIMPLED TUBE	VH	C	4	14	BL	6 3/4	32 1/8	C	38	A	N	284078
										6 3/4	32 1/8	C	38	A		
39 3/4	30 3/16	3	NAVISTAR	S SERIES ULTRA-FUSED CAN USE 226142 OR 251116	VH	C	4	14	BL	6 3/4	32 1/8	1 3/4	38	A	N	284740
										6 3/4	32 1/8	1 3/4	38	A		
39 7/8	27 5/16	2 1/4	NAVISTAR	9370, 9670 ULTRA-FUSED CAN USE 226893	VH	C	3	14	BL	6	30 3/4	C	40	A	N	284693
										6	30 3/4	C	40	A		
39 7/8	28 1/2	2 1/4	NAVISTAR	9370, 9670 ULTRA-FUSED LOW FLOW CAN USE 251036 DIMPLED TUBE	VH	C	3	14	BL	6	30 3/4	C	40	A	N	284035
										6	30 3/4	C	40	A		
39 7/8	28 1/2	3	NAVISTAR	9370, 9670 ULTRA-FUSED CAN USE 226684	VH	C	4	11	BL	6	30 3/4	C	40	A	N	284305
										6	30 3/4	C	40	A		
39 7/8	28 1/2	3	NAVISTAR	9370, 9670 ULTRA-FUSED LOW FLOW CAN USE 251021 DIMPLED TUBE	VH	C	4	14	BL	6	30 3/4	C	40	A	N	284703
										6	30 3/4	C	40	A		
39 7/8	30	3 7/16	MARMON TRUCK	HYY BTM HDR	R	C	6	11	BL	10 1/2	31 3/4	1 3/4	42	A	C	226620
										BH	8	31 3/4	1 3/4	40		
39 7/8	35 15/16	2 1/4	NAVISTAR	9370, 9670 ULTRA-FUSED CAN USE 226146	VH	C	3	13	BL	6	38 1/8	C	48	A	N	284315
										6	38 1/8	C	48	A		
39 7/8	35 15/16	3	NAVISTAR	9370, 9670 573101-C91 ULTRA-FUSED LOW FLOW CAN USE 251028 DIMPLED TUBE	VH	C	4	13	BL	6	38 1/8	C	48	A	N	284692
										6	38 1/8	C	48	A		
39 15/16	28	2 1/4	NAVISTAR	9370, 9670 CAN USE 226893	VH	C	3	14	BL	6	30 3/4	C	40	A	N	251120
										6	30 3/4	C	40	A		
39 15/16	28	2 1/4	NAVISTAR	9370, 9670 LOW FLOW CAN USE 284035 DIMPLED TUBE	VH	C	3	15	BL	6	30 3/4	C	40	A	N	251036
										6	30 3/4	C	40	A		
39 15/16	28	3	NAVISTAR	9370, 9670 CAN USE 226197	VH	C	4	14	BL	6	30 3/4	C	40	A	N	251113
										6	30 3/4	C	40	A		

Vista-Pro Automotive - Core Catalog
(Cores Sorted by Size)

Height	Width	Depth	Application	Description	Fin Type	Fin Matl	Rows	FPI	BH / TH Type	BH / TH Width	BH / TH Length	BH / TH OHF	BH / TH Bolts	BH / TH Shape	Hdr Support	Model #
39 15/16	28 1/8	2 3/8	INTERNATIONAL	9370, 9670 CAN USE 284693	R	C	4	11	BL	6	30 3/4	1 1/2	40	A	C	226893
									BL	6	30 3/4	1 1/2	40	A		
39 15/16	28 1/8	2 3/8	NAVISTAR	9370, 9670 LOW FLOW CAN USE 284035 DIMPLED TUBE	R	C	4	11	BL	6	30 3/4	C	40	A	C	226035
									BL	6	30 3/4	C	40	A		
39 15/16	28 1/8	2 7/8	NAVISTAR	9360, 9670 LOW FLOW CAN USE 284703 DIMPLED TUBE	R	C	5	11	BL	6	30 3/4	C	40	A	C	226013
									BL	6	30 3/4	C	40	A		
39 15/16	28 1/8	2 7/8	NAVISTAR	9670 CAN USE 284305	R	C	5	10	BL	6	30 3/4	1 1/2	40	A	C	226684
									BL	6	30 3/4	1 1/2	40	A		
39 15/16	28 3/16	2 1/4	NAVISTAR	SEE 251021 DIMPLED TUBE	VTH	C	3	16	BL	6	30 3/4	C	40	A	N	253021
									BL	6	30 3/4	C	40	A		
39 15/16	29 3/8	2 3/8	NAVISTAR	9370, 9670	R	C	4	11	BL	6	30 3/4	C	40	A	C	226144
									BL	6	30 3/4	C	40	A		
39 15/16	29 3/8	2 7/8	NAVISTAR	9670	R	C	5	11	BL	6	30 3/4	C	40	A	C	226197
									BL	6	30 3/4	C	40	A		
39 15/16	35 3/8	2 1/4	NAVISTAR	SEE 251028 DIMPLED TUBE	VTH	C	3	16	BL	6	38 1/8	C	48	A	N	253028
									BL	6	38 1/8	C	48	A		
39 15/16	35 3/8	3	NAVISTAR	SEE 251028 DIMPLED TUBE	VTH	C	4	15	BL	6	38 1/8	C	48	A	N	252028
									BL	6	38 1/8	C	48	A		
39 15/16	35 1/2	3	NAVISTAR	9370, 9670 LOW FLOW DIMPLED TUBE	VH	C	4	15	BL	6	38 1/8	C	48	A	N	251028
									BL	6	38 1/8	C	48	A		
39 15/16	35 5/8	2 3/8	NAVISTAR	9370, 9670	R	C	4	11	BL	6	38 1/8	1 7/16	48	A	C	226146
									BL	6	38 1/8	1 7/16	48	A		
39 15/16	35 5/8	2 7/8	NAVISTAR	9370, 9670 LOW FLOW DIMPLED TUBE	R	C	5	11	BL	6	38 1/8	C	48	A	C	226023
									BL	6	38 1/8	C	48	A		
39 15/16	35 5/8	2 7/8	NAVISTAR	9370, 9670	R	C	5	11	BL	6	38 1/8	1 5/8	48	A	C	226685
									BL	6	38 1/8	1 5/8	48	A		
40	6 3/16	2 1/4	INGERSOLL-RAND	R-600 SECTIONAL	T	C	3	9	GR	2 3/4	6	3/16		A	C	261157
									GR	2 3/4	6	3/16	A			
40	27 1/2	5 3/16	KOMATSU	HVY T/BTM HDRS BRASS FINS	Z	B	7	8	BH	7 5/8	30 1/4	C	32	A	C	285151
									BH	7 5/8	30 1/4	C	32	A		
40	28 1/2	2 1/4	KENWORTH	K100 LOW FLOW CAN USE 284055 DIMPLED TUBE	VH	C	3	15	BL	7 5/16	32 1/8	C	40	A	N	251040
									BL	7 5/16	32 1/8	C	40	A		
40	28 1/2	2 1/4	KENWORTH	K100 W-900 T-600 ULTRA-FUSED E-2651 CAN USE 226143 OR 251002	VH	C	3	14	BL	7 3/8	32 1/8	2 1/2	40	A	N	284080
									BL	7 3/8	32 1/8	2 1/2	40	A		
40	28 1/2	2 1/4	KENWORTH	T400 E-2651	VH	C	3	14	BL	7 3/8	32 1/8	2 1/2	40	A	N	251002
									BL	7 3/8	32 1/8	2 1/2	40	A		
40	28 1/2	3	KENWORTH	K100E W900B T600A ULTRA-FUSED LOW FLOW CAN USE 251010 DIMPLED TUBE	VH	C	4	13	BL	7 5/16	32 1/8	C	40	A	N	284626
									BL	7 5/16	32 1/8	C	40	A		
40	28 1/2	3	KENWORTH	K100E LOW FLOW CAN USE 284626 DIMPLED TUBE	VH	C	4	15	BL	7 5/16	32 1/8	C	40	A	N	251010
									BL	7 5/16	32 1/8	C	40	A		
40	28 1/2	3	KENWORTH	CAN USE 226100	VH	C	4	14	BL	7 3/8	32 1/8	2 1/2	40	A	N	251103
									BL	7 3/8	32 1/8	2 1/2	40	A		
40	28 5/8	1 1/2	KENWORTH	SEE 251002	VTH	C	2	16	BL	7 3/8	32 1/8	2 1/2	40	A	N	253002
									BL	7 3/8	32 1/8	2 1/2	40	A		
40	28 5/8	2 1/4	KENWORTH	SEE 251040 DIMPLED TUBE	VTH	C	3	15	BL	7 5/16	32 1/8	C	40	A	N	252040
									BL	7 5/16	32 1/8	C	40	A		
40	28 5/8	2 1/4	KENWORTH	SEE 251002	VTH	C	3	14	BL	7 3/8	32 1/8	2 1/2	40	A	N	252002
									BL	7 3/8	32 1/8	2 1/2	40	A		
40	28 5/8	2 1/4	KENWORTH	SEE 251103	VTH	C	3	14	BL	7 3/8	32 1/8	2 1/2	40	A	N	253103
									BL	7 3/8	32 1/8	2 1/2	40	A		
40	28 5/8	3	KENWORTH	SEE 251103	VTH	C	4	14	BL	7 3/8	32 1/8	2 1/2	40	A	N	252103
									BL	7 3/8	32 1/8	2 1/2	40	A		
40	28 3/4	2 3/8	KENWORTH	K100 LOW FLOW CAN USE 284055 DIMPLED TUBE	R	C	4	11	BL	7 5/16	32 1/8	C	40	A	C	226040
									BL	7 5/16	32 1/8	C	40	A		
40	28 3/4	2 3/8	KENWORTH	K100, W900, T600 E-2614, E-2651	R	C	4	11	BL	7 5/16	32 1/8	C	40	A	C	226143
									BL	7 5/16	32 1/8	C	40	A		
40	28 3/4	2 7/8	KENWORTH	K100E LOW FLOW CAN USE 284626 DIMPLED TUBE	R	C	5	11	BL	7 5/16	32 1/8	C	40	A	C	226032
									BL	7 5/16	32 1/8	C	40	A		
40	28 3/4	2 7/8	KENWORTH	T600A	R	C	5	11	BL	7 3/8	32 1/8	C	40	A	C	226100
									BL	7 3/8	32 1/8	C	40	A		
40	28 3/4	2 7/8	KENWORTH	LOW FLOW, SHORT CLIP DIMPLED TUBE	R	C	5	11	BL	7 5/16	32 1/8	C	40	A	C	266032
									BL	7 5/16	32 1/8	C	40	A		

Vista-Pro Automotive - Core Catalog
(Cores Sorted by Size)

Height	Width	Depth	Application	Description	Fin Type	Fin Matl	Rows	FPI	BH / TH Type	BH / TH Width	BH / TH Length	BH / TH OHF	BH / TH Bolts	BH / TH Shape	Hdr Support	Model #
40	28 3/4	3 7/16	KENWORTH		R	C	6	10	BL BL	7 5/16 7 5/16	32 1/8 32 1/8	C C	40 40	A A	C	226814
40	29 1/16	2 1/4	KENWORTH	K100E, W900B ULTRA-FUSED LOW FLOW CAN USE 251040 DIMPLED TUBE	VH	C	3	13	BL BL	7 5/16 7 5/16	32 1/8 32 1/8	C C	40 40	A A	N	284055
40	29 1/16	3	KENWORTH	ULTRA-FUSED CAN USE 251103	VH	C	4	13	BL BL	7 5/16 7 5/16	32 1/8 32 1/8	2 1/2 2 1/2	40 40	A A	N	284653
40	30	3 7/16	KENWORTH	K094-105	R	C	6	11	BL BL	7 5/16 7 5/16	32 1/8 32 1/8	C C	40 40	A A	C	226557
40	30	3 7/16	MARMON TRUCK		R	C	6	11	BL BL	10 1/2 8	31 3/4 31 3/4	1 3/4 1 3/4	42 40	A A	C	226622
40	32 1/2	5 3/16	LIFT TRUCKS & LOADERS	MICHIGAN HVY T/BTM HDRS BRASS FINS	Z	B	7	8	BH BH	9 1/8 7 7/8	36 36	C C	48 48	A A	C	289777
40	32 5/8	4 1/2	LIFT TRUCKS & LOADERS	MICHIGAN 275A HVY T/BTM HDRS	T	C	6	8	BH BH	9 1/4 7 7/8	36 36	C C	48 48	A A	C	275234
40	33 3/4	2 3/8	KENWORTH	K100 K194-1375-1	R	C	4	11	BL BL	7 3/8 7 3/8	36 1/8 36 1/8	C C	44 44	A A	C	226558
40	33 3/4	3 7/16	KENWORTH	K100 COE	R	C	6	11	BL BL	7 3/8 7 3/8	36 1/8 36 1/8	C C	44 44	A A	C	226203
40	33 3/4	4 7/16	KENWORTH	K100 COE	R	C	8	11	BL BL	7 3/8 7 3/8	36 1/8 36 1/8	C C	46 46	A A	C	226559
40	36	4 1/2	CATERPILLAR	D339 HVY T/BTM HDRS BRASS FINS	T	B	6	8	BH BH	7 1/2 7 1/2	40 40	C C	46 46	A A	C	272799
40	37 1/2	4 7/16	CATERPILLAR	637 SCRAPER 7N1580 HVY T/BTM HDRS BRASS FINS	Z	B	6	9	BH BH	8 8	40 40	C C	38 38	A A	C	225538
40	37 1/2	6	CATERPILLAR	637 SCRAPER 4N7295 HVY T/BTM HDRS BRASS FINS	Z	B	8	9	BH BH	8 8	40 40	C C	38 38	A A	C	225182
40	37 1/2	6	CATERPILLAR	637 SCRAPER 4N7295 HVY T/BTM HDRS BRASS FINS FACE DIPPED	B	B	8	6	BH BH	8 8	40 40	C C	38 38	A A	C	278837
40	41 7/8	4 7/16	CATERPILLAR	BRASS FINS 4 CORES PER RAD	Z	B	6	9	BL BL	7 1/2 7 1/2	45 1/2 45 1/2	C C	52 52	A A	CC	225399
40	47 1/4	4 1/2	EUCLID	HVY T/BTM HDRS 1 1/8" BTWN HOLES 4 & 5	T	C	6	8	BH BH	8 1/2 8 1/2	51 7/8 51 7/8	C C	50 50	H H	CC	272858
40	47 1/4	4 1/2	EUCLID	HVY T/BTM HDRS 1 3/4" BTWN HOLES 4 & 5	T	C	6	8	BH BH	8 1/2 8 1/2	51 7/8 51 7/8	C C	50 50	H H	CC	273419
40	47 1/4	5 1/4	EUCLID	TS-24 HVY T/BTM HDRS	T	C	7	7	BH BH	8 1/2 8 1/2	51 7/8 51 7/8	C C	50 50	H H	CC	279068
40	47 1/2	4 7/16	EUCLID	TS-24 4018328, 9028437 HVY T/BTM HDRS BRASS FINS 1 1/8" BTWN HOLES 5 & 6	Z	B	6	9	BH BH	8 1/2 8 1/2	51 7/8 51 7/8	1 5/8 1 5/8	50 50	H H	CC	225639
40	47 1/2	4 7/16	EUCLID	TS-24 HVY BTM HDR BRASS FINS 1 1/8" BTWN HOLES 4 & 5	Z	B	6	7	BL BH	8 1/2 8 1/2	51 7/8 51 7/8	1 5/8 1 5/8	50 50	H H	CC	288440
40	47 1/2	4 5/8	EUCLID	TS-24 HVY T/BTM HDRS	X	C	6	9	BH BH	8 1/2 8 1/2	51 7/8 51 7/8	C C	50 50	H H	CC	266082
40	28 3/4	2 7/8	KENWORTH		R	C	5	11	BL BL	7 3/8 7 3/8	32 1/8 32 1/8	2 3/8 2 3/8	40 40	A A	C	266100
40 3/16	35	2 3/8	MACK TRUCKS		R	C	4	11	BL BL	6 7/8 6 7/8	37 1/8 37 1/8	C C	44 44	A A	C	226605
40 3/16	36 7/8	3 11/16	DRESSER INDUSTRIES	HVY T/BTM HDRS BRASS FINS	Z	B	5	6	BH BH	7 1/4 7 1/4	39 1/4 39 1/4	C C	50 50	A A	C	285216
40 1/4	34 3/8	2 7/8	MACK TRUCKS	HVY BTM HDR	R	C	5	11	BL BH	6 7/8 6 7/8	37 37	C C	44 44	A A	C	226606
40 3/8	25 1/2	6	CATERPILLAR	977L HVY T/BTM HDRS BRASS FINS FACE DIPPED 4 CRNRS OF CORE NOTCHED	B	B	8	7	BH BH	8 1/4 8 1/4	28 1/8 26 7/8	C C	28 26	F F	C	229564
40 3/8	25 1/2	6	CATERPILLAR	977L HVY T/BTM HDRS BRASS FINS 4 CRNRS OF CORE NOTCHED	B	B	8	7	BH BH	8 1/4 8 1/4	28 1/8 26 7/8	C C	28 26	F F	C	229610
40 3/8	25 5/8	6	CATERPILLAR	977L 1P1683 HVY T/BTM HDRS BRASS FINS 4 CRNRS OF CORE NOTCHED	Z	B	8	9	BH BH	8 1/4 8 1/4	28 1/8 26 7/8	C C	28 26	F F	F	225124
40 3/8	25 5/8	6	CATERPILLAR	977L 1P1683 HVY T/BTM HDRS HVY STEEL FINS 4 CRNRS OF CORE NOTCHED	Z	S	8	9	BH BH	8 1/4 8 1/4	28 1/8 26 7/8	C C	28 26	F F	F	225832

Vista-Pro Automotive - Core Catalog
(Cores Sorted by Size)

Height	Width	Depth	Application	Description	Fin Type	Fin Matl	Rows	FPI	BH / TH Type	BH / TH Width	BH / TH Length	BH / TH OHF	BH / TH Bolts	BH / TH Shape	Hdr Support	Model #
40 3/8	25 7/8	6	CATERPILLAR	977L HVY T/BTM HDRS BRASS FINS 4 CRNRS OF CORE NOTCHED	T	B	8	9	BH BH	8 1/4 8 1/4	28 1/8 26 7/8	C	28 26	F F	C	265024
40 7/16	30 5/8	6	CATERPILLAR	977K 5S7261 HVY T/BTM HDRS BRASS FINS 4 CRNRS OF CORE NOTCHED	Z	B	8	8	BH BH	8 1/4 8	35 1/2 32 1/4	C	36 32	F F	F	225045
40 7/16	30 15/16	6	CATERPILLAR	977K HVY T/BTM HDRS BRASS FINS 4 CRNRS OF CORE NOTCHED	T	B	8	9	BH BH	8 1/4 8	35 1/2 32 1/4	C	36 32	A A	C	264065
40 7/16	31	6	CATERPILLAR	977K HVY T/BTM HDRS BRASS FINS FACE DIPPED 4 CRNRS OF CORE NOTCHED	B	B	8	7	BH BH	8 1/4 8	35 1/2 32 1/4	C	36 32	A A	C	229544
40 7/16	31	6	CATERPILLAR	977K HVY T/BTM HDRS BRASS FINS 4 CRNRS OF CORE NOTCHED	B	B	8	7	BH BH	8 1/4 8	35 1/2 32 1/4	C	36 32	A A	C	229611
40 1/2	29 3/8	2 3/8	DIAMOND REO	C-116 HVY BTM HDR TEMPLATE #3	R	C	4	9	BL BH	10 3/8 6	31 1/4 31 1/4	2 7/8 C	54 42	B B	C	226429
40 3/4	34 3/8	5 3/16	CAT-LeMASTER	980C w/OC** REPL 15 SECTIONS	Z	C	7	7	BH BH	7 7	35 35	C	42 42	0 0	C	284298
40 3/4	34 7/8	5 1/4	CAT-LeMASTER	980C W/OC 1W8649 GROUP REPL 11 CORES BRASS 441003 O/C AVAIL	T	B	7	7	BH BH	7 7	34 3/4 34 3/4	C	40 40	0 0	C	274150
40 3/4	35	5 3/16	CAT-LeMASTER	980C W/OC 1W8649 GROUP REPL 11 CORES BRASS FINS441003 O/C AVAIL	Z	B	7	7	BH BH	7 7	34 3/4 34 3/4	C	40 40	A A	C	284150
40 3/4	36 1/4	4 7/16	GENERAL ELECTRIC	80 TON LOCOMOTIVE BRASS FINS	Z	B	6	7	BL BL	6 7/8 6 7/8	38 3/4 38 3/4	C	34 34	A A	C	287991
40 3/4	36 9/16	3 3/4	GENERAL ELECTRIC	80 TON LOCOMOTIVE HVY BTM HDR	T	C	5	8	BL BH	6 7/8 6 7/8	38 3/4 38 3/4	C	34 34	A A	C	276785
40 3/4	38 3/4	5 3/16	CAT-LeMASTER	825, 826C W/OC ** 2W0037 GROUP REPL 13 CORES BRASS FINS441004 O/C AVAIL	Z	B	7	7	BH BH	7 7	39 39	C	46 46	0 0	F	284166
40 3/4	38 13/16	5 1/4	CAT-LeMASTER	825, 826C W/OC ** 2W0037 GROUP REPL 13 CORES BRASS 441004 O/C AVAIL	T	B	7	7	BH BH	7 7	39 39	C	46 46	0 0	C	274166
40 3/4	43 1/8	5 3/16	CAT-LeMASTER	980F (IMRM) REPL 9 CORES BRASS FINS	Z	B	7	9	BH BH	7 7	43 1/2 43 1/2	C	48 48	0 0	CC	284224
40 3/4	43 5/16	5 1/4	CAT-LeMASTER	980F (IMRM) REPL 9 CORES BRASS FINS	T	B	7	9	BH BH	7 7	43 1/2 43 1/2	C	48 48	0 0	CC	274224
40 7/8	29 3/8	3 7/16	CRANE CARRIER		R	C	6	11	BL BL	6 7/8 6 7/8	31 1/4 31 1/4	C	42 42	A A	C	226410
41	29 1/4	3	NAVISTAR	TRANSTAR HVY BTM HDR	T	C	4	11	BL BH	9 1/2 8 1/8	31 3/4 31 3/4	2 1/2 1 7/8	40 40	F F	C	265514
41	29 1/4	3 3/4	NAVISTAR	TRANSTAR 318 HVY BTM HDR	T	C	5	11	BL BH	9 1/2 8 1/8	31 3/4 31 3/4	2 1/2 1 13/16	40 40	F F	C	265515
41	29 3/8	2 3/8	NAVISTAR	4070B CAN USE 281921	R	C	4	11	BL BL	9 1/2 8 1/8	31 3/4 31 3/4	2 1/2 1 3/4	40 40	F F	C	226198
41	29 3/8	2 7/8	NAVISTAR	4070B TRANSTAR	R	C	5	11	BL BL	9 1/2 8 1/8	31 3/4 31 3/4	2 1/2 2	40 40	F F	C	226247
41	29 3/8	3 7/16	NAVISTAR	4070B HVY BTM HDR	R	C	6	11	BL BH	9 1/2 8 1/8	31 3/4 31 3/4	2 1/2 1 7/8	40 40	F F	C	226687
41	29 1/2	3	PETERBILT		VTH	C	4	14	BL BH	6 6	31 1/4 31 1/4	C	42 42	0 0	N	252117
41	29 1/2	3	NAVISTAR	4070-B CAN USE 226247	VH	C	4	14	BL BL	9 1/2 8 1/8	31 3/4 31 3/4	2 1/2 2	40 40	F F	N	251117
41	37 1/2	6	CATERPILLAR	637 SCRAPER 8S4199 HVY T/BTM HDRS BRASS FINS	Z	B	8	9	BH BH	8 8	40 40	C	38 38	A A	C	225086
41	37 1/2	6	CATERPILLAR	637 SCRAPER HVY T/BTM HDRS BRASS FINS FACE DIPPED	B	B	8	7	BH BH	8 8	40 40	C	38 38	A A	C	272580
41 1/8	21 1/4	2 7/8	GARDNER DENVER	450 CFM COMPRESSOR 1157590T1	S	C	5	9	GR GR	3 7/16 3 7/16	21 15/16 21 15/16	C		A A	C	229076
41 1/8	40 1/2	5 1/4	KOMATSU	D-85 HVY T/BTM HDRS BRASS FINS FACE DIPPED	B	B	7	7	BH BH	7 9/16 7 9/16	44 1/8 44 1/8	C	48 48	A A	CC	272523
41 1/4	46 1/4	3 7/16	BLUE BIRD BUS	X-3190 E-2269 HVY BTM HDR	R	C	6	11	BL BH	6 7/8 6 7/8	48 1/4 48 1/4	C	70 70	A A	CC	226894

Vista-Pro Automotive - Core Catalog
(Cores Sorted by Size)

Height	Width	Depth	Application	Description	Fin Type	Fin Matl	Rows	FPI	BH / TH Type	BH / TH Width	BH / TH Length	BH / TH OHF	BH / TH Bolts	BH / TH Shape	Hdr Support	Model #
41 1/2	20	6	JOHN DEERE	855 AT54889 HVY T/BTM HDRS BRASS FINS	Z	B	8	8	BH	9 1/8	22 1/2	C	40	A	C	282564
									BH	9 1/8	22 1/2	C	40	A		
41 1/2	26 7/8	3 15/16	JOHN DEERE	8640 HVY T/BTM HDRS	S	C	7	10	BH	6 1/8	28 5/8	C	36	A	C	229202
									BH	7 1/8	28 5/8	C	38	A		
41 1/2	26 7/8	3 15/16	JOHN DEERE	8640 HVY T/BTM HDRS	S	C	7	9	BH	6 1/8	28 5/8	C	40	A	C	272902
									BH	6 1/8	28 5/8	C	40	A		
41 1/2	31 1/2	3 3/4	CATERPILLAR	D398 HVY T/BTM HDRS 4 CORES PER RAD	T	C	5	8	BH	7 1/2	34	C	42	A	C	272581
									BH	7 1/2	34	C	42	A		
41 1/2	31 1/2	4 1/2	CATERPILLAR	D398 HVY T/BTM HDRS 4 CORES PER RAD	T	C	6	8	BH	7 1/2	34	C	40	A	C	272808
									BH	7 1/2	34	C	40	A		
41 1/2	34 7/8	3 3/4	FIAT ALLIS	25,000 HVY BTM HDR SPECIFY BH SPACING	T	C	5	7	BL	7 1/4	37 1/2	1 1/2	46	B	C	272450
									BH	7 1/4	37 1/2	1 1/2	46	B		
41 1/2	34 7/8	3 3/4	FIAT ALLIS	25,000 HVY T/BTM HDRS SPECIFY BH SPACING	T	C	5	7	BH	7 1/4	37 1/2	1 1/2	48	B	C	275433
									BH	7 1/4	37 1/2	1 1/2	48	B		
41 1/2	36	5 1/4	LIFT TRUCKS & LOADERS	MICHIGAN HVY T/BTM HDRS	T	C	7	8	BH	9 1/4	40	C	52	A	C	279722
									BH	8 1/4	40	C	52	A		
41 9/16	21 1/4	3 11/16	CATERPILLAR	963 TRACK LOADER 1W1502 HVY T/BTM HDRS BRASS FINS	Z	B	5	9	BH	9 13/16	23 5/16	C	30	F	F	225204
									BH	9 13/16	23 5/16	C	30	F		
41 9/16	21 1/4	3 11/16	CATERPILLAR	963 TRACK LOADER 1W1502 HVY T/BTM HDRS HVY STEEL FINS	Z	S	5	9	BH	9 13/16	23 5/16	C	30	F	F	225814
									BH	9 13/16	23 5/16	C	30	F		
41 9/16	21 3/8	3 3/4	CATERPILLAR	963 TRACK LOADER HVY T/BTM HDRS HVY STEEL FINS	T	S	5	9	BH	9 13/16	23 5/16	C	30	F	C	266460
									BH	9 13/16	23 5/16	C	30	F		
41 5/8	35	2 3/8	ONAN	STATIONARY UNIT W/WAUKESHA ENGINE HVY BTM HDR	R	C	4	9	BL	7 3/8	37 1/2	2 3/8	48	A	C	226702
									BH	7 3/8	37 1/2	2 3/8	48	A		
41 5/8	41 1/4	4 7/16	DETROIT DIESEL	V-12 1783-7200 HVY T/BTM HDRS BRASS FINS	Z	B	6	9	BH	8 3/4	43 5/8	C	54	A	CC	288472
									BH	8 3/4	43 5/8	C	54	A		
41 5/8	41 5/8	3 3/4	DETROIT DIESEL	HVY BTM HDR	T	C	5	8	BL	8 3/4	43 5/8	C	54	A	CC	275463
									BH	8 3/4	43 5/8	C	54	A		
41 5/8	41 5/8	4 1/2	DETROIT DIESEL	12V-71 HVY BTM HDR	T	C	6	8	BL	8 3/4	43 5/8	C	54	A	CC	223124
									BH	8 3/4	43 5/8	C	54	A		
41 3/4	40 1/2	4 1/2	DETROIT DIESEL	HVY T/BTM HDRS	T	C	6	8	BH	8	43 5/8	C	54	A	CC	272865
									BH	8	43 5/8	C	54	A		
42	19 3/8	4 7/16	CHEV/GMC	BUS; RTS 06	R	C	8	11	BL	8	22 1/4	C	38	A	C	225705
									BL	8	22 1/4	C	38	A		
42	34 7/8	3 3/4	PETERBILT	HVY T/BTM HDRS	T	C	5	7	BH	8	37 1/2	C	44	A	C	266594
									BH	8	37 1/2	C	44	A		
42	34 7/8	4 1/2	CUMMINS ENGINE	MH220 HVY T/BTM HDRS	T	C	6	9	BH	8	39 1/2	C	50	A	C	223085
									BH	8	39 1/2	C	50	A		
42	34 7/8	4 1/2	DETROIT DIESEL		T	C	6	8	BL	8	39 5/8	C	50	A	C	272651
									BL	8	39 5/8	C	50	A		
42	35	3	PETERBILT	362 07-04788	X	C	4	8	BL	8	37 1/2	C	44	F	C	281889
									BL	8	37 1/2	C	44	F		
42	35	3 7/16	PETERBILT	362	R	C	6	11	BL	8	37 1/2	1 3/4	44	F	C	226253
									BL	8	37 1/2	1 3/4	44	F		
42	35	4 7/16	CUMMINS ENGINE	MH220 HVY BTM HDR BRASS FINS	Z	B	6	11	BL	8	39 1/2	C	50	A	C	225487
									BH	8	39 1/2	C	50	A		
42	36 1/4	4 7/16	KOEHRING	BRASS FINS END HOLES 2 3/16"	Z	B	6	9	BL	7 1/2	39 1/2	C	50	A	C	282720
									BL	7 1/2	39 1/2	C	50	A		
42	36 1/4	6	DRESSER INDUSTRIES	TD-20 1209720-H91 HVY T/BTM HDRS HVY STEEL FINS	Z	S	8	7	BH	9	39 1/16	C	50	A	C	225950
									BH	9	39 1/16	C	50	A		
42	39 3/8	2 3/16	CATERPILLAR	16 GRADER 7N3457 HVY T/BTM HDRS HVY STEEL FINS CTR SUPPORT FINS	Z	S	3	9	BH	8 7/8	42 3/8	C	44	A	C	225912
									BH	8 7/8	42 3/8	C	44	A		
42	39 3/8	2 1/4	CATERPILLAR	16G GRADER HVY T/BTM HDRS HVY STEEL FINS	T	S	3	9	BH	8 7/8	42 3/8	C	44	A	C	266469
									BH	8 7/8	42 3/8	C	44	A		
42	39 3/8	3	CATERPILLAR	16 GRADER HVY T/BTM HDRS	T	C	4	8	BH	8 7/8	42 3/8	C	44	A	C	272807
									BH	8 7/8	42 3/8	C	44	A		
42	39 15/16	4 1/2	CATERPILLAR	621B, 623B HVY T/BTM HDRS HVY STEEL FINS	T	S	6	10	BH	8 7/8	42 3/8	3	44	A	C	265605
									BH	8 7/8	42 3/8	3	44	A		
42	40	2 15/16	CATERPILLAR	7N1478 HVY T/BTM HDRS	Z	C	4	9	BH	8 7/8	42 3/8	2 1/4	44	A	C	225094
									BH	8 7/8	42 3/8	2 1/4	44	A		

Vista-Pro Automotive - Core Catalog
(Cores Sorted by Size)

Height	Width	Depth	Application	Description	Fin Type	Fin Matl	Rows	FPI	BH / TH Type	BH / TH Width	BH / TH Length	BH / TH OHF	BH / TH Bolts	BH / TH Shape	Hdr Support	Model #
42	40	4 7/16	CATERPILLAR	627B 4N9374 HVY T/BTM HDRS BRASS FINS	Z	B	6	9	BH	8 7/8	42 3/8	1 7/16	44	A	F	225074
											BH	8 7/8	42 3/8	1 7/16	44	
42	40	5 3/16	CATERPILLAR	621B, 623B 4N4342 HVY T/BTM HDRS BRASS FINS	Z	B	7	9	BH	8 7/8	42 3/8	C	44	A	F	225171
											BH	8 7/8	42 3/8	C	44	
42	40	5 3/16	CATERPILLAR	621B, 623B 4N4342 HVY T/BTM HDRS HVY STEEL FINS	Z	S	7	9	BH	8 7/8	42 3/8	C	44	A	F	225831
											BH	8 7/8	42 3/8	C	44	
42	40	5 1/4	CATERPILLAR	621B, 623B 4N4342 HVY T/BTM HDRS	B	C	7	6	BH	8 7/8	42 3/8	1 5/8	44	A	C	278839
											BH	8 7/8	42 3/8	1 5/8	44	
42	41 5/8	3 3/4	DETROIT DIESEL	HVY T/BTM HDRS	T	C	5	8	BH	8 3/4	43 3/4	C	54	A	CC	272652
											BH	8 3/4	43 3/4	C	54	
42	42 3/16	4 1/2	CUMMINS ENGINE	350 DIESEL HVY T/BTM HDRS	T	C	6	9	BH	8	43 1/2	C	54	A	CC	272489
											BH	8	43 1/2	C	54	
42	49 3/8	4 7/16	TEREX	82-50 DOZER HVY T/BTM HDRS BRASS FINS	Z	B	6	9	BH	8 3/8	53	C	64	A	CC	281962
											BH	8 3/8	53	C	64	
42	52 1/2	3 7/16	INGERSOLL-RAND	HVY BTM HDR	R	C	6	9	BL	6	53 7/8	C	66	A	CC	226518
											BH	6	53 7/8	C	66	
42	50	5 1/4	OSHKOSH		B	B	7	10	BI	9 1/4	53	C	64	A	F	279042
											BI	9 1/4	53	C	64	
42 1/8	40	3 11/16	CATERPILLAR	621B, 623B 8N5980 HVY T/BTM HDRS CTR SUPPORT FINS	Z	C	5	9	BH	8 7/8	42 3/8	C	44	A	C	225088
											BH	8 7/8	42 3/8	C	44	
42 1/8	40	3 11/16	CATERPILLAR	621B, 623B 8N5980 HVY T/BTM HDRS HVY STEEL FINS CTR SUPPORT FINS	Z	S	5	9	BH	8 7/8	42 3/8	C	44	A	C	225905
											BH	8 7/8	42 3/8	C	44	
42 1/8	40	5 3/16	CATERPILLAR	621B, 623B 8N5979 HVY T/BTM HDRS BRASS FINS CTR SUPPORT FINS	Z	B	7	9	BH	8 7/8	42 3/8	C	44	A	C	225114
											BH	8 7/8	42 3/8	C	44	
42 1/8	40	5 3/16	CATERPILLAR	621B, 623B 8N5979 HVY T/BTM HDRS HVY STEEL FINS CTR SUPPORT FINS	Z	S	7	9	BH	8 7/8	42 3/8	C	44	A	F	225907
											BH	8 7/8	42 3/8	C	44	
42 1/2	27 1/2	1 3/4	MACK TRUCKS	CRUISELINER COE E-1674-10	R	C	3	11	BL	6 1/2	29 1/2	C	38	A	C	226231
											BL	6 1/2	29 1/2	C	38	
42 1/2	27 1/2	2 3/8	MACK TRUCKS	CRUISELINER COE E-1674-1	R	C	4	11	BL	6 1/2	29 1/2	C	38	A	C	226232
											BL	6 1/2	29 1/2	C	38	
42 1/2	27 1/2	2 7/8	MACK TRUCKS	CRUISELINER COE	R	C	5	11	BL	6 1/2	29 1/2	C	38	A	C	226234
											BL	6 1/2	29 1/2	C	38	
42 1/2	27 1/2	3 7/16	MACK TRUCKS	CRUISELINER COE E-1674-3	R	C	6	11	BL	6 1/2	29 1/2	C	38	A	C	226236
											SQ	6 1/2	29 1/2	C	38	
42 1/2	27 9/16	3	MACK TRUCKS	CRUISELINER COE HVY BTM HDR	T	C	4	11	BL	6 1/2	29 1/2	C	38	A	C	265547
											BH	6 1/2	29 1/2	C	38	
42 1/2	42 1/2	3 7/16	CUMMINS/DETROIT		R	C	6	11	BL	7 1/8	45	C	52	A	CC	226855
											BL	7 1/8	45	C	52	
42 1/2	42 1/2	3 7/16	DETROIT DIESEL	HVY T/BTM HDRS	S	C	6	11	BH	7 1/4	45	C	52	A	CC	272875
											BH	7 1/4	45	C	52	
42 3/4	27 15/16	2 1/4	NAVISTAR	9400 ULTRA-FUSED CAN USE 251121	VH	C	3	13	BL	6	31 1/4	C	42	B	N	284010
											BL	6	31 1/4	C	42	
42 3/4	27 15/16	3	NAVISTAR	ULTRA-FUSED LOW FLOW CAN USE 251007 DIMPLED TUBE	VH	C	4	14	BL	6	31 1/4	C	42	B	N	284715
											BL	6	31 1/4	C	42	
42 3/4	28	2 1/4	NAVISTAR	9400 CAN USE 284010	VH	C	3	14	BL	6	31 1/4	C	42	B	N	251121
											BL	6	31 1/4	C	42	
42 3/4	28	2 1/4	NAVISTAR	9400 LOW FLOW DIMPLED TUBE	VH	C	3	15	BL	6	31 1/4	C	42	B	N	251037
											BL	6	31 1/4	C	42	
42 3/4	28	3	NAVISTAR	9400 E2590-2	VH	C	4	14	BL	6	31 1/4	C	42	B	N	251124
											BL	6	31 1/4	C	42	
42 3/4	28	3	NAVISTAR	9400 SERIES LOW FLOW CAN USE 284715 DIMPLED TUBE	VH	C	4	15	BL	6	31 1/4	C	42	B	N	251007
											BL	6	31 1/4	C	42	
42 3/4	28 1/8	2 3/8	NAVISTAR	9400 LOW FLOW DIMPLED TUBE	R	C	4	11	BL	6	31 1/4	C	42	B	C	226036
											BL	6	31 1/4	C	42	
42 3/4	28 1/8	2 3/8	NAVISTAR	9400	R	C	4	11	BL	6	31 1/4	C	42	B	C	226147
											BL	6	31 1/4	C	42	
42 3/4	28 1/8	2 7/8	NAVISTAR	9400 SERIES LOW FLOW CAN USE 284715 DIMPLED TUBE	R	C	5	11	BL	6	31 1/4	C	42	B	C	226026
											BL	6	31 1/4	C	42	
42 3/4	28 1/8	2 7/8	NAVISTAR		R	C	5	11	BL	6	31 1/4	C	42	F	C	226851
											BL	6	31 1/4	C	42	

Vista-Pro Automotive - Core Catalog
(Cores Sorted by Size)

Height	Width	Depth	Application	Description	Fin Type	Fin Matl	Rows	FPI	BH / TH Type	BH / TH Width	BH / TH Length	BH / TH OHF	BH / TH Bolts	BH / TH Shape	Hdr Support	Model #
42 3/4	28 1/8	2 7/8	NAVISTAR	9400 SERIES	R	C	5	11	BL BL	6 6	31 1/4 31 1/4	C C	42 42	B B	C	226844
42 3/4	28 3/16	1 1/2	NAVISTAR	SEE 251121	VTH	C	2	16	BL BL	6 6	31 1/4 31 1/4	C C	42 42	B B	N	253121
42 3/4	28 3/16	2 1/4	NAVISTAR	SEE 251121	VTH	C	3	14	BL BL	6 6	31 1/4 31 1/4	C C	42 42	B B	N	252121
42 3/4	28 3/16	2 1/4	NAVISTAR	SEE 251007 DIMPLED TUBE	VTH	C	3	16	BL BL	6 6	31 1/4 31 1/4	C C	42 42	B B	N	253007
42 3/4	28 3/16	3	NAVISTAR	SEE 251007 DIMPLED TUBE	VTH	C	4	15	BL BL	6 6	31 1/4 31 1/4	C C	42 42	B B	N	252007
42 13/16	34 3/8	3 11/16	CATERPILLAR	966D 8N1692 HVY T/BTM HDRS BRASS FINNS	Z	B	5	9	BH BH	9 9	37 9/16 37 9/16	C C	42 42	F F	F	225184
42 13/16	34 3/8	3 11/16	CATERPILLAR	966D 8N1692 HVY T/BTM HDRS HVY STEEL FINNS	Z	S	5	9	BH BH	9 9	37 9/16 37 9/16	C C	42 42	F F	F	225844
42 13/16	34 1/2	3 3/4	CATERPILLAR	966D HVY T/BTM HDRS BRASS FINNS FACE DIPPED	B	B	5	7	BH BH	9 9	37 9/16 37 9/16	C C	42 42	F F	C	272582
42 13/16	34 1/2	3 3/4	CATERPILLAR	966D HVY T/BTM HDRS	B	C	5	7	BH BH	9 9	37 9/16 37 9/16	C C	42 42	F F	C	272809
42 13/16	34 7/8	3 3/4	CATERPILLAR	966D WHEEL LOADER HVY T/BTM HDRS HVY STEEL FINNS	T	S	5	9	BH BH	9 9	37 9/16 37 9/16	C C	42 42	F F	C	266461
42 13/16	39 15/16	4 1/2	CATERPILLAR	D-7 HVY T/BTM HDRS BRASS FINNS RVS CTR MTG BAR	T	B	6	7	BH BH	6 9/16 6 9/16	41 1/2 41 1/2	C C	38 38	E E	F	264016
42 13/16	40	2 15/16	CATERPILLAR	D-7 3S3565 HVY T/BTM HDRS HVY STEEL FINNS SGL CTR MTG BAR 4 CRNRS NOTCHED	Z	S	4	6	BH BH	6 9/16 6 9/16	41 1/2 41 1/2	1 1/4 1 1/4	38 38	E E	F	225864
42 13/16	40	4 7/16	CATERPILLAR	D-7F 3R2605 HVY T/BTM HDRS BRASS FINNS RVS CTR MTG BAR 4 CRNRS NOTCHED	Z	B	6	9	BH BH	6 9/16 6 9/16	41 1/2 41 1/2	C C	38 38	E E	F	225052
42 13/16	40	4 7/16	CATERPILLAR	D-7F 3R2605 HVY T/BTM HDRS BRASS FINNS SGL CTR MTG BAR 4 CRNRS NOTCHED	Z	B	6	9	BH BH	6 9/16 6 9/16	41 1/2 41 1/2	C C	38 38	E E	F	225117
42 13/16	40	4 7/16	CATERPILLAR	D-7F 3S4069 HVY T/BTM HDRS HVY STEEL FINNS SGL CTR MTG BAR 4 CRNRS NOTCHED	Z	S	6	9	BH BH	6 9/16 6 9/16	41 1/2 41 1/2	C C	38 38	E E	F	225845
42 13/16	40	4 1/2	CATERPILLAR	D-7F HVY T/BTM HDRS BRASS FINNS FACE DIPPED RVS CTR MTG BAR	B	B	6	7	BH BH	6 9/16 6 9/16	41 1/2 41 1/2	C C	38 38	E E	F	229568
42 13/16	40	4 1/2	CATERPILLAR	D-7 HVY T/BTM HDRS SGL CTR MTG BAR BRASS FINNS	B	B	6	7	BH BH	6 9/16 6 9/16	41 1/2 41 1/2	C C	38 38	E E	F	229612
42 13/16	40 1/2	4 1/2	CATERPILLAR	816B COMPACTOR HVY T/BTM HDRS HVY STEEL FINNS	T	S	6	7	BH BH	9 9	43 5/8 43 5/8	C C	50 50	A A	CC	266455
42 13/16	40 5/8	3 11/16	CATERPILLAR	8N3108 HVY T/BTM HDRS	Z	C	5	9	BH BH	9 9	43 5/8 43 5/8	C C	50 50	A A	CC	225122
42 13/16	40 5/8	4 7/16	CATERPILLAR	816B 8N5382, 8N5471 HVY T/BTM HDRS HVY STEEL FINNS	Z	S	6	6	BH BH	9 9	43 5/8 43 5/8	C C	50 50	A A	F	225860
42 7/8	38 1/8	3 7/16	MACK TRUCKS	COE CRUISE LINER	R	C	6	11	BL BL	6 1/2 6 1/2	40 40	C C	48 48	A A	C	226237
42 7/8	42 1/2	3 11/16	CATERPILLAR	D343, D353 2N5125 HVY T/BTM HDRS BRASS FINNS	Z	B	5	9	BH BH	8 8	45 1/2 45 1/2	C C	54 54	A A	CC	225397
42 7/8	42 1/2	3 3/4	CATERPILLAR	D353 HVY T/BTM HDRS BRASS FINNS FACE DIPPED	B	B	5	6	BH BH	8 8	45 1/2 45 1/2	C C	54 54	A A	CC	277136
42 7/8	42 1/2	5 3/16	V.M.E.	VOLVO MICHIGAN LOADER HVY T/BTM HDRS BRASS FINNS	Z	B	7	9	BH BH	9 3/8 9 3/8	44 7/8 44 7/8	C C	58 58	A A	CC	285221
42 7/8	42 3/4	3 3/4	CATERPILLAR	D353 HVY T/BTM HDRS	T	C	5	9	BH BH	8 8	45 1/2 45 1/2	C C	54 54	A A	CC	272605
42 7/8	42 3/4	4 1/2	CATERPILLAR	D343, D353 HVY T/BTM HDRS	T	C	6	10	BH BH	8 8	45 1/2 45 1/2	C C	54 54	A A	CC	265604
43	27 1/2	3 7/16	MACK TRUCKS	WESTERN E-1462-5, E-1555-5 HVY BTM HDR	R	C	6	11	BL BL	10 1/4 6	29 1/2 29 1/2	1 5/16 1 5/16	42 40	A A	C	226238
43	36 1/4	6	DRESSER INDUSTRIES	TD-20 HVY T/BTM HDRS BRASS FINNS	Z	B	8	7	BH BH	9 9	39 1/16 39 1/16	C C	50 50	A A	C	225624

Vista-Pro Automotive - Core Catalog
(Cores Sorted by Size)

Height	Width	Depth	Application	Description	Fin Type	Fin Matl	Rows	FPI	BH / TH Type	BH / TH Width	BH / TH Length	BH / TH OHF	BH / TH Bolts	BH / TH Shape	Hdr Support	Model #
43	36 1/4	6	DRESSER INDUSTRIES	TD-20 719806-C1 HVY T/BTM HDRS HVY STEEL FINS	Z	S	8	7	BH BH	9 9	39 1/16 39 1/16	C C	50 50	A A	C	225963
43	38 1/4	5 1/4	HALLIBURTON	HVY T/BTM HDRS	T	C	7	9	BH BH	8 1/4 8 1/4	41 1/4 41 1/4	C C	50 50	A A	C	272880
43	38 13/16	5 1/4	HALLIBURTON	HVY T/BTM HDRS	T	C	7	8	BH BH	8 1/4 8 1/4	41 1/4 41 1/4	C C	50 50	A A	C	272683
43	42 3/16	3 3/4	HALLIBURTON	HVY T/BTM HDRS	T	C	5	9	BH BH	8 8	45 1/2 45 1/2	C C	54 54	A A	CC	272684
43 1/4	30 5/8	1 3/4	MACK TRUCKS		R	C	3	11	BL BL	6 3/8 6 3/8	33 33	C C	40 40	A A	C	226610
43 1/4	30 5/8	2 3/8	MACK TRUCKS	R MODEL 3MF-5372-P2, E-1906 CAN USE 282123	R	C	4	11	BL BL	6 3/8 6 3/8	33 33	C C	40 40	A A	C	226239
43 1/4	30 5/8	2 3/8	MACK TRUCKS	ULTRA-FUSED CAN USE 226239	R	C	4	11	BL BL	6 3/8 6 3/8	33 33	2 2	40 40	A A	C	282123
43 1/4	30 5/8	2 7/8	MACK TRUCKS	R MODEL 3MF-5372-P	R	C	5	11	BL BL	6 3/8 6 3/8	33 33	C C	40 40	A A	C	226240
43 1/4	33	2 1/4	FORD TRUCK	LTL9000 LOW FLOW TEMPLATE #6A CAN USE 284337 DIMPLED TUBE	VH	C	3	15	BL BL	9 5 7/16	36 3/4 36 3/4	1 1/4 1 1/4	52 48	B B	N	251011
43 1/4	33 1/16	2 1/4	FORD TRUCK	LTL9000 ULTRA-FUSED LOW FLOW TEMPLATE #6B CAN USE 251011 DIMPLED TUBE	VH	C	3	15	BL BL	9 5 7/16	36 3/4 36 3/4	1 1/4 1 1/4	52 48	B B	N	284337
43 1/4	33 1/16	2 1/4	FORD TRUCK	LTL9000 ULTRA-FUSED TEMPLATE #6A CAN USE 226110	VH	C	3	15	BL BL	9 5 7/16	36 3/4 36 3/4	1 1/4 1 1/4	52 48	B B	N	284723
43 1/4	33 1/8	2 3/8	FORD TRUCK	LTL9000 LOW FLOW TEMPLATE #6A CAN USE 284337 DIMPLED TUBE	R	C	4	11	BL BL	9 5 7/16	36 3/4 36 3/4	1 1/4 1 1/4	52 48	B B	C	226000
43 1/4	33 1/8	2 3/8	FORD TRUCK	LTL9000 TEMPLATE #6A	R	C	4	11	BL BL	9 5 7/16	36 3/4 36 3/4	1 1/4 1 1/4	52 48	B B	C	226110
43 1/4	46 1/4	2 7/8	MILITARY	MILITARY CORE, LVS-MK-48	R	C	5	10	BH BH	7 3/4 7 3/4	49 49	C C	60 60	0 0	CC	220036
43 3/8	28 1/8	3 7/16	PIERCE FIRE TRUCK	FIRE TRUCK	R	C	6	11	BL BL	7 7	30 3/8 30 3/8	C C	42 42	A A	C	226287
43 3/8	35	2 7/8	VOLVO WHITEGMC	ROAD BOSS II 1100717 HVY BTM HDR	R	C	5	11	BL BH	7 7	37 7/8 37 7/8	2 5/8 2 5/8	50 50	A A	C	226772
43 3/8	35	3 7/16	VOLVO WHITEGMC	ROAD BOSS II 1100718 HVY BTM HDR	R	C	6	11	BL BH	7 7	37 7/8 37 7/8	1 15/16 1 15/16	50 50	A A	C	226774
43 1/2	39 3/8	2 15/16	CATERPILLAR	D-7G 4N7279 HVY T/BTM HDRS HVY STEEL FINS SGL CTR MTG BAR	Z	S	4	9	BH BH	7 7/8 7 7/8	43 3/4 41	2 1/8 2 1/8	44 40	G A	F	225929
43 1/2	39 3/8	4 7/16	CATERPILLAR	D-7G HVY T/BTM HDRS BRASS FINS SGL CTR MTG BAR	Z	B	6	9	BH BH	7 7/8 7 7/8	43 7/8 41	1 5/16 1 5/16	46 40	G A	F	225089
43 1/2	39 3/8	4 7/16	CATERPILLAR	D-7G 6N1218 HVY T/BTM HDRS BRASS FINS SGL CTR MTG BAR	Z	B	6	9	BH BH	7 7/8 7 7/8	43 3/4 41	1 1/4 1 1/4	44 40	F A	F	225148
43 1/2	39 3/8	4 7/16	CATERPILLAR	D-7G 6N1218 HVY T/BTM HDRS HVY STEEL FINS SGL CTR MTG BAR	Z	S	6	9	BH BH	7 7/8 7 7/8	43 3/4 41	1 1/4 1 1/4	44 40	F A	F	225815
43 1/2	39 3/8	4 1/2	CATERPILLAR	D-7G HVY T/BTM HDRS BRASS FINS SGL CTR MTG BAR	T	B	6	7	BH BH	7 7/8 7 7/8	43 3/4 41	1 3/8 1 3/8	44 40	G A	F	265492
43 1/2	39 3/8	4 1/2	CATERPILLAR	D-7G HVY T/BTM HDRS BRASS FINS SGL CTR MTG BAR	T	B	6	7	BH BH	7 7/8 7 7/8	43 3/4 41	1 1/4 1 1/4	46 40	G A	F	265879
43 1/2	39 3/8	5 3/16	CATERPILLAR	D-7G 7N2343 HVY T/BTM HDRS BRASS FINS SGL CTR MTG BAR	Z	B	7	9	BH BH	7 7/8 7 7/8	43 3/4 41	C C	44 40	G A	F	225146
43 1/2	39 1/2	4 1/2	CATERPILLAR	D-7G HVY T/BTM HDRS SGL CTR MTG BAR BRASS FINS FACE DIPPED	B	B	6	7	BH BH	7 7/8 7 7/8	43 3/4 41	1 3/8 1 3/8	44 40	G A	F	229545
43 1/2	39 1/2	4 1/2	CATERPILLAR	D-7G HVY T/BTM HDRS SGL CTR MTG BAR BRASS FINS	B	B	6	7	BH BH	7 7/8 7 7/8	43 3/4 41	1 3/8 1 3/8	44 40	G A	F	229614
43 1/2	43 3/4	6	TEREX	9059681 HVY T/BTM HDRS BRASS FINS	Z	B	8	8	BH BH	10 1/2 10 1/2	49 49	C C	62 62	A A	CC	225485
43 1/2	48 1/8	4 7/16	OSHKOSH TRUCK	FIRE TRUCK, HVY T/BTM HDRS BRASS FINS	Z	B	6	11	BH BH	8 8	50 1/2 50 1/2	C C	70 70	A A	CC	282700

Vista-Pro Automotive - Core Catalog
(Cores Sorted by Size)

Height	Width	Depth	Application	Description	Fin Type	Fin Matl	Rows	FPI	BH / TH Type	BH / TH Width	BH / TH Length	BH / TH OHF	BH / TH Bolts	BH / TH Shape	Hdr Support	Model #
43 3/4	29 3/8	3 7/16	NAVISTAR	PAYSTAR HVY T/BTM HDRS TEMPLATE #14	R	C	6	11	BH BH	10 1/4 6 7/8	31 1/4 31 1/4	1 5/8 1 5/8	54 40	A A	C	226691
43 3/4	42 1/2	5 3/16	CAT-LeMASTER	D-8L W/AC REPL 14 CORES BRASS FINS	Z	B	7	7	BH BH	7 7	43 43	C	50 50	0 0	CC	284228
43 3/4	42 1/2	5 3/16	CAT-LeMASTER	D-8L WO/AC 4W1796 GROUP REPL 14 CORES BRASS FINS	Z	B	7	7	BH BH	7 7	43 43	C	50 50	A A	CC	284174
43 3/4	42 3/4	5 1/4	CAT-LeMASTER	D-8L W/AC REPL 14 CORES BRASS FINS	T	B	7	7	BH BH	7 7	43 43	C	50 50	0 0	CC	274228
43 3/4	42 3/4	5 1/4	CAT-LeMASTER	D-8L WO/AC 4W1796 GROUP REPL 14 CORES BRASS FINS	T	B	7	7	BH BH	7 7	43 43	C	50 50	0 0	CC	274174
43 3/4	43 1/8	5 3/16	CAT-LeMASTER	657E SCRAPER REPL 9 CORES	Z	C	7	7	BH BH	7 7	43 1/2 43 1/2	C	50 50	0 0	CC	284280
43 3/4	43 3/4	5 3/16	CAT-LeMASTER	D-9N WO/AC 7W2847 REPL 15 CORES BRASS FINS	Z	B	7	7	BH BH	7 7	44 44	C	50 50	A A	CC	284102
43 3/4	43 3/4	5 3/16	CAT-LeMASTER	D-8N (MRM) REPL 9 CORES BRASS FINS	Z	B	7	9	BH BH	7 7	44 44	C	50 50	A A	CC	284162
43 3/4	43 3/4	5 3/16	CAT-LeMASTER	D-9N W/AC 7W8887 REPL 16 CORES BRASS FINS	Z	B	7	7	BH BH	7 7	44 44	C	50 50	0 0	CC	284164
43 3/4	43 7/8	5 1/4	CAT-LeMASTER	D-9N WO/AC 7W2847 REPL 15 CORES BRASS FINS	T	B	7	7	BH BH	7 7	44 44	C	50 50	0 0	CC	274102
43 3/4	43 7/8	5 1/4	CAT-LeMASTER	D-8N (MRM) REPL 9 CORES BRASS FINS	T	B	7	9	BH BH	7 7	44 44	C	50 50	0 0	CC	274162
43 3/4	43 7/8	5 1/4	CAT-LeMASTER	D-9N W/AC 7W8887 REPL 16 CORES BRASS FINS	T	B	7	7	BH BH	7 7	44 44	C	50 50	0 0	CC	274164
43 3/4	45 5/8	5 3/16	CAT-LeMASTER	3408 GEN SET REPL 10 CORES BRASS FINS	Z	B	7	7	BH BH	7 7	46 46	C	52 52	0 0	CC	284272
43 3/4	47 1/4	5 1/4	CAT-LeMASTER	631E, 637E FRONT 2W0029 REPL 11 CORES BRASS FINS	T	B	7	7	BH BH	7 7	47 1/2 47 1/2	C	54 54	0 0	CC	274104
43 3/4	47 1/4	5 1/4	CAT-LeMASTER	769C 35 TON TRUCK 2W1991 GROUP REPL 15 CORES BRASS FINS	T	B	7	7	BH BH	7 7	47 5/8 47 5/8	C	54 54	0 0	CC	274238
43 3/4	47 1/4	5 1/4	CAT-LeMASTER	988B REPL 13 CORES BRASS FINS	T	B	7	7	BH BH	7 7	47 5/8 47 5/8	C	54 54	0 0	CC	274152
43 3/4	47 1/2	5 3/16	CAT-LeMASTER	631E, 637E FRONT 2W0029 REPL 11 CORES BRASS FINS	Z	B	7	7	BH BH	7 7	47 1/2 47 1/2	C	54 54	A A	CC	284104
43 3/4	47 1/2	5 3/16	CAT-LeMASTER	769C 35 TON TRUCK 2W1991 GROUP REPL 15 CORES BRASS FINS	Z	B	7	7	BH BH	7 7	47 5/8 47 5/8	C	54 54	0 0	CC	284238
43 3/4	47 1/2	5 3/16	CAT-LeMASTER	988B REPL 16 CORES BRASS FINS	Z	B	7	7	BH BH	7 7	47 1/2 47 1/2	C	54 54	0 0	CC	284232
43 3/4	47 1/2	5 3/16	CAT-LeMASTER	988B REPL 13 CORES BRASS FINS	Z	B	7	7	BH BH	7 7	47 5/8 47 5/8	C	54 54	0 0	CC	284152
43 3/4	50 5/8	5 3/16	CAT-LeMASTER	3412 GEN SET REPL 11 CORES BRASS FINS	Z	B	7	7	BH BH	7 7	51 51	C	54 54	0 0	CC	284270
43 7/8	36	4 1/2	LeTOURNEAU	12V-71 DETROIT DIESEL HVY T/BTM HDRS	T	C	6	6	BH BH	7 1/2 7 1/2	39 39	C	46 46	A A	C	275021
43 7/8	36 1/4	4 5/8	LeTOURNEAU	HVY T/BTM HDRS	X	C	6	9	BH BH	8 8	39 39	C	46 46	A A	C	266122
43 7/8	36 1/4	5 3/16	LeTOURNEAU	12V-71 DETROIT DIESEL HVY BTM HDR BRASS FINS	Z	B	7	9	BL BH	8 8	39 39	C	46 46	A A	C	288805
44	26 7/8	2 7/8	CHEV/GMC	BRIGADIER	R	C	5	11	BL BL	6 1/8 6 1/8	29 1/2 29 1/2	1 7/8 1 7/8	40 40	A A	C	226386
44	27 3/8	3	CHEV/GMC	BRIGADIER ULTRA-FUSED LOW FLOW CAN USE 226025 DIMPLED TUBE	VH	C	4	14	BL BL	7 6 3/8	29 7/8 29 7/8	1 9/16 1 5/16	42 42	XX XX	N	284709
44	27 1/2	2 7/8	CHEV/GMC	BRIGADIER LOW FLOW CAN USE 284709 DIMPLED TUBE	R	C	5	11	BL BL	7 6 3/8	29 7/8 29 7/8	1 9/16 1 5/16	42 42	A A	C	226025
44	27 1/2	2 7/8	CHEV/GMC	ASTRO TEMPLATE #8	R	C	5	11	BL BL	10 3/8 6 1/4	29 5/8 29 5/8	1 1/2 1 1/2	44 40	A A	C	226122
44	27 1/2	2 7/8	CHEV/GMC	BRIGADIER 15511855	R	C	5	11	BL BL	7 6 3/8	29 7/8 29 7/8	1 3/4 1 3/8	42 42	A A	C	226248
44	27 1/2	2 7/8	CHEV/GMC	ASTRO TEMPLATE #10	R	C	5	10	BL BL	10 3/8 6 1/4	29 5/8 29 5/8	1 1/2 1 1/2	44 40	A A	C	226332

Vista-Pro Automotive - Core Catalog
(Cores Sorted by Size)

Height	Width	Depth	Application	Description	Fin Type	Fin Matl	Rows	FPI	BH / TH Type	BH / TH Width	BH / TH Length	BH / TH OHF	BH / TH Bolts	BH / TH Shape	Hdr Support	Model #
44	27 1/2	2 7/8	CHEV/GMC	BRIGADIER	R	C	5	10	BL BL	6 3/8 6 3/8	29 7/8 29 7/8	1 3/8 1 3/8	42 42	A A	C C	226388
44	27 1/2	2 7/8	CHEV/GMC	BRIGADIER	R	C	5	11	BL BL	7 7	29 7/8 29 7/8	1 5/8 1 5/8	42 42	A A	C C	226389
44	27 1/2	2 7/8	CHEV/GMC	ASTRO 9500 TEMPLATE #10	R	C	5	10	BL BL	10 3/8 6 1/4	29 5/8 29 5/8	1 5/8 1 3/8	44 40	A A	C C	226390
44	27 1/2	2 7/8	CHEV/GMC	ASTRO TEMPLATE #7	R	C	5	10	BL BL	10 3/8 6 1/4	29 5/8 29 5/8	1 5/8 1 3/8	44 40	A A	C C	226391
44	27 1/2	3	GMC TRUCK	BRIGADIER LOW FLOW CAN USE 284709 DIMPLED TUBE	VH	C	4	15	BL BL	7 6 3/8	29 7/8 29 7/8	1 3/4 1 3/8	42 42	A A	N N	251030
44	27 1/2	3	GMC TRUCK	BRIGADIER CAN USE 226248	VH	C	4	14	BL BL	7 6 3/8	29 7/8 29 7/8	1 3/4 1 3/8	42 42	A A	N N	251100
44	27 1/2	3 7/16	CHEV/GMC	BRIGADIER	R	C	6	11	BL BL	7 6 3/8	29 7/8 29 7/8	1 3/4 1 3/8	42 42	A A	C C	226392
44	27 1/2	3 7/16	CHEV/GMC	ASTRO TEMPLATE #7	R	C	6	10	BL BL	10 3/8 6 1/4	29 5/8 29 5/8	1 5/8 1 3/8	44 40	A A	C C	226393
44	27 9/16	3	CHEV/GMC	BRIGADIER	T	C	4	10	BL BL	7 6 3/8	29 7/8 29 7/8	1 5/8 1 5/8	42 42	A A	C C	265569
44	28 1/8	2 7/8	CHEV/GMC	BRIGADIER	R	C	5	11	BL BL	7 6 3/8	29 7/8 29 7/8	1 5/8 1 3/8	42 42	B B	C C	226395
44	29 3/8	3 7/16	NAVISTAR	5050 PAYSTAR HVY BTM HDR TEMPLATE #15	R	C	6	11	BL BH	10 1/4 6 7/8	31 1/4 31 1/4	1 1/2 1 1/2	54 40	A A	C C	226693
44	31 7/8	2 7/8	CHEV/GMC	BRIGADIER	R	C	5	11	BL BL	7 6 5/8	33 33	1 5/8 1 5/8	42 42	A A	C C	226396
44	34 3/8	2 3/8	MACK TRUCKS	E-1919	R	C	4	11	BL BL	6 1/4 6 1/4	36 3/8 36 3/8	1 3/4 1 3/4	46 46	A A	C C	226612
44	34 3/8	2 7/8	MACK TRUCKS	MH, RW LOW FLOW CAN USE 284695 DIMPLED TUBE	R	C	5	11	BL BL	6 1/4 6 1/4	36 3/8 36 3/8	C C	46 46	A A	C C	226018
44	34 3/8	2 7/8	MACK TRUCKS	3MF-5395-AM3	R	C	5	11	BL BL	6 1/4 6 1/4	36 3/8 36 3/8	1 3/4 1 3/4	46 46	A A	C C	226613
44	34 1/2	3	MACK TRUCKS	MH, RW LOW FLOW CAN USE 284695 DIMPLED TUBE	VH	C	4	15	BL BL	6 1/4 6 1/4	36 3/8 36 3/8	C C	46 46	A A	N N	251025
44	41 5/8	4 1/2	DETROIT DIESEL	HVY T/BTM HDRS	T	C	6	8	BH BH	8 8	42 42	C C	48 48	A A	CC CC	272653
44	46 1/8	2 1/4	SULLAIR	DETROIT ENGINE	T	C	3	8	BL BL	5 7/8 5 7/8	48 5/8 48 5/8	C C	56 56	A A	CC CC	279933
44	47 1/4	4 1/2	V.M.E.	R-50 HAUL TRUCK HVY T/BTM HDRS	T	C	6	7	BH BH	8 1/2 8 1/2	51 7/8 51 7/8	C C	50 50	H H	CC CC	223594
44	47 1/2	4 7/16	EUCLID	4018329 HVY T/BTM HDRS BRASS FINNS	Z	B	6	9	BH BH	8 1/2 8 1/2	51 7/8 51 7/8	1 5/8 1 5/8	50 50	H H	CC CC	288927
44	53 7/16	3 3/4	EUCLID	50 TON HVY T/BTM HDRS	T	C	5	8	BH BH	9 1/2 9 1/2	59 59	C C	62 62	A A	CC CC	272635
44	53 7/16	4 1/2	EUCLID	50 TON 4019474 HVY T/BTM HDRS	T	C	6	7	BH BH	9 1/2 9 1/2	59 59	C C	62 62	A A	CC CC	279070
44	53 3/4	4 7/16	EUCLID	50 TON 4019474, 4071254 HVY T/BTM HDRS BRASS FINNS	Z	B	6	7	BH BH	9 1/2 9 1/2	59 59	C C	62 62	A A	CC CC	289869
44 5/16	40	6	CATERPILLAR	824, 834 2S2433 HVY T/BTM HDRS BRASS FINNS 4 CRNRS OF CORE NOTCHED	Z	B	8	9	BH BH	8 8	41 1/4 41 1/4	C C	40 40	F F	F F	225165
44 5/16	40	6	CATERPILLAR	824, 834 9S6157 HVY T/BTM HDRS HVY STEEL FINNS 4 CRNRS OF CORE NOTCHED	Z	S	8	9	BH BH	8 8	41 1/4 41 1/4	C C	40 40	F F	F F	225873
44 5/16	40 1/2	6	CATERPILLAR	HVY T/BTM HDRS BRASS FINNS FACE DIPPED 4 CRNRS OF CORE NOTCHED	B	B	8	6	BH BH	8 8	41 1/4 41 1/4	C C	40 40	F F	CC CC	275441
44 3/8	36	6	CATERPILLAR	988 HVY T/BTM HDRS 4 CRNRS NOTCHED OFFSET FOR O/C	T	C	8	7	BH BH	8 8	41 3/8 37 3/8	C C	40 36	F F	C C	275392
44 3/8	36 1/4	6	CATERPILLAR	988 LOADER 9S4103 HVY T/BTM HDRS BRASS FINNS 4 CRNRS NOTCHED OFFSET FOR O/C	Z	B	8	9	BH BH	8 8	41 1/4 37 1/4	C C	40 36	F F	F F	225037
44 3/8	36 1/4	6	CATERPILLAR	988 LOADER 9S4103 HVY T/BTM HDRS HVY STEEL FINNS 4 CRNRS NOTCHED OFFSET FOR O/C	Z	S	8	9	BH BH	8 8	41 1/4 37 1/4	C C	40 36	F F	F F	225846

Vista-Pro Automotive - Core Catalog
(Cores Sorted by Size)

Height	Width	Depth	Application	Description	Fin Type	Fin Matl	Rows	FPI	BH / TH Type	BH / TH Width	BH / TH Length	BH / TH OHF	BH / TH Bolts	BH / TH Shape	Hdr Support	Model #
44 1/2	25	3 7/16	INGERSOLL-RAND	A-900 CFM 36732873 HVY T/BTM HDRS	R	C	6	11	BH BH	6 7/8 6 7/8	27 1/4 27 1/4	C C	34 34	A A	C	226519
44 1/2	42 1/2	4 7/16	FIAT ALLIS	HD-21C 70687292 HVY T/BTM HDRS BRASS FINS	Z	B	6	8	BH BH	8 8	44 1/2 44 1/2	1 1/2 1 1/2	54 54	A A	CC	286519
44 9/16	30 5/8	2 3/8	MACK TRUCKS		R	C	4	9	BL BL	6 3/8 6 3/8	33 33	1 1/2 1 1/2	40 40	A A	C	226241
44 9/16	30 5/8	2 7/8	MACK TRUCKS		R	C	5	10	BL BL	6 3/8 6 3/8	33 33	C C	40 40	A A	C	226615
44 15/16	38 3/4	5 3/16	CATERPILLAR	824, 825, 826 6N9785 HVY T/BTM HDRS BRASS FINS CTR SUPPORT FINS	Z	B	7	9	BH BH	8 7/8 8 7/8	41 5/16 41 5/16	C C	42 42	A A	C	225202
44 15/16	38 3/4	6	CATERPILLAR	824, 825, 826 8N3062, 8N3064 HVY T/BTM HDRS BRASS FINS CTR SUPPORT FINS	Z	B	8	9	BH BH	8 7/8 8 7/8	41 5/16 41 5/16	C C	42 42	A A	F	225201
44 15/16	38 3/4	6	CATERPILLAR	824, 825, 826 8N3062, 8N3064 HVY T/BTM HDRS HVY STEEL FINS CTR SUPPORT FINS	Z	S	8	9	BH BH	8 7/8 8 7/8	41 5/16 41 5/16	C C	42 42	A A	F	225816
44 15/16	39	5 1/4	CATERPILLAR	824C HVY T/BTM HDRS BRASS FINS FACE DIPPED	B	B	7	7	BH BH	8 7/8 8 7/8	41 5/16 41 5/16	C C	42 42	A A	C	272585
44 15/16	39	6	CATERPILLAR	824C HVY T/BTM HDRS BRASS FINS FACE DIPPED	B	B	8	7	BH BH	8 7/8 8 7/8	41 5/16 41 5/16	C C	42 42	A A	C	272586
45	30	6	GARDNER DENVER	1200 CFM HVY BTM HDR BRASS FINS	Z	B	8	9	BL BH	9 5/8 9 5/8	32 1/4 32 1/4	C C	46 46	A A	C	282682
45	30 1/2	4 1/2	KOMATSU	HVY T/BTM HDRS CORE OFFSET FOR O/C	B	C	6	7	BH BH	6 7/8 6 7/8	36 36	C C	38 38	A A	C	272910
45	30 5/8	4 7/16	KOMATSU	D-75 HVY T/BTM HDRS BRASS FINS CORE OFFSET FOR O/C	Z	B	6	9	BH BH	6 7/8 6 7/8	36 36	C C	38 38	A A	C	285150
45	44 3/8	5 3/16	KOMATSU	LOADER HVY T/BTM HDRS BRASS FINS	Z	B	7	9	BH BH	8 1/2 8 1/2	46 46	C C	60 60	A A	CC	285224
45	45	3 11/16	INGERSOLL-RAND	75-D WAUKESHA	Z	C	5	11	BL BL	7 1/4 7 1/4	47 1/2 47 1/2	2 1/8 2 1/8	54 54	A A	CC	281833
45	45	3 3/4	BUCYRUS ERIE	45R HVY T/BTM HDRS	T	C	5	11	BH BH	7 1/4 7 1/4	47 1/2 47 1/2	C C	54 54	A A	CC	223064
45	45	3 3/4	WAUKESHA	DDV-75.C71 HVY T/BTM HDRS	T	C	5	9	BH BH	7 1/4 7 1/4	47 1/2 47 1/2	C C	54 54	A A	CC	272954
45	46 7/8	2 7/8	DETROIT DIESEL	GEN SET FULL REINF T/HDR HVY BTM HDR	R	C	5	11	BL BH	9 9	49 1/8 49 1/8	C C	56 56	F 0	CC	226848
45	47 13/16	3 3/4	CATERPILLAR	3406 HVY T/BTM HDRS	T	C	5	9	BH BH	13 9	50 50	2 1/4 2 1/4	54 50	A A	CC	223621
45	47 13/16	4 1/2	CATERPILLAR	3408, 3412 HVY T/BTM HDRS	T	C	6	9	BH BH	13 9	50 50	2 1/4 2 1/4	54 50	A A	CC	223114
45	47 13/16	5 1/4	CATERPILLAR	3408 HVY T/BTM HDRS	T	C	7	9	BH BH	13 9	50 50	2 1/4 2 1/4	54 50	A A	CC	266463
45	48 1/8	3 11/16	CATERPILLAR	3408, 3412 8N4880 HVY BTM HDR BRASS FINS REINFORCED T/HDR	Z	B	5	9	BH BH	13 9	50 50	2 1/4 2 1/4	54 50	A A	F	225196
45	48 1/8	4 7/16	CATERPILLAR	3408, 3412 4N8559 HVY T/BTM HDR BRASS FINS REINFORCED T/HDR	Z	B	6	9	BH BH	13 9	50 50	2 1/4 2 1/4	54 50	A A	F	225195
45	48 1/8	5 3/16	CATERPILLAR	3408, 3412 HVY BTM HDR BRASS FINS REINFORCED T/HDR	Z	B	7	9	BH BH	13 9	50 50	2 1/4 2 1/4	54 50	A A	CC	225197
45 1/4	45	3 11/16	CATERPILLAR	245 EXCAVATOR 4N9471 HVY T/BTM HDRS	Z	C	5	9	BH BH	8 7/8 8 7/8	49 7/8 49 7/8	1 1/2 1 1/2	50 50	A A	CC	225156
45 1/4	45	5 3/16	CATERPILLAR	245 EXCAVATOR 6N413 HVY T/BTM HDRS HVY STEEL FINS	Z	S	7	9	BH BH	8 7/8 8 7/8	49 7/8 49 7/8	C C	50 50	A A	F	225830
45 1/4	45	6	CATERPILLAR	245 SHOVEL 9Y3311 HVY T/BTM HDRS BRASS FINS	Z	B	8	9	BH BH	8 7/8 8 7/8	49 7/8 49 7/8	1 1/2 1 1/2	50 50	A A	CC	225162
45 5/16	43 3/4	3 11/16	CATERPILLAR	980C 6N9786 HVY T/BTM HDR BRASS FINS CTR SUPPORT FINS	Z	B	5	9	BH BH	8 7/8 8 7/8	46 3/4 46 3/4	C C	48 48	A A	CC	225203
45 5/16	43 3/4	3 11/16	CATERPILLAR	980C 6N9786 HVY T/BTM HDR HVY STEEL FINS CTR SUPPORT FINS	Z	S	5	9	BH BH	8 7/8 8 7/8	46 3/4 46 3/4	C C	48 48	A A	CC	225819

Vista-Pro Automotive - Core Catalog
(Cores Sorted by Size)

Height	Width	Depth	Application	Description	Fin Type	Fin Matl	Rows	FPI	BH / TH Type	BH / TH Width	BH / TH Length	BH / TH OHF	BH / TH Bolts	BH / TH Shape	Hdr Support	Model #
45 3/8	36 7/8	4 7/16	FIAT ALLIS	HD-20 BRASS FINs	Z	B	6	7	SQ SQ	5 1/4 5 1/4	37 1/4 37 1/4	C C		A A	C	282170
45 3/8	43 3/4	5 3/16	LIFT TRUCKS & LOADERS	HOUGH 560 E-2525 HVY T/BTM HDRS BRASS FINs	Z	B	7	9	BH BH	8 3/8 8 3/8	46 1/4 46 1/4	C C	58 58	A A	CC	282726
45 1/2	42 1/2	3 11/16	CATERPILLAR	D-8H 8S2646 HVY T/BTM HDRS BRASS FINs SGL CTR MTG BAR	Z	B	5	9	BH BH	6 9/16 6 9/16	45 1/2 45 1/2	C C	40 40	F F	F	225207
45 1/2	42 1/2	4 7/16	CATERPILLAR	D-8H 8S2639 8S2645 HVY T/BTM HDRS BRASS FINs SGL CTR MTG BAR	Z	B	6	9	BH BH	6 9/16 6 9/16	45 1/2 45 1/2	C C	40 40	F F	F	225033
45 1/2	42 1/2	4 7/16	CATERPILLAR	D-8H 8S2645 8S2639 HVY T/BTM HDRS BRASS FINs RVS CTR MTG BAR	Z	B	6	9	BH BH	6 9/16 6 9/16	45 1/2 45 1/2	C C	40 40	F F	F	225093
45 1/2	42 1/2	4 7/16	CATERPILLAR	D-8H 8S2639 HVY T/BTM HDRS HVY STEEL FINs SGL CTR MTG BAR	Z	S	6	9	BH BH	6 9/16 6 9/16	45 1/2 45 1/2	C C	40 40	F F	F	225820
45 1/2	42 1/2	4 7/16	CATERPILLAR	D-8H 8S2639 8S2645 HVY T/BTM HDRS HVY STEEL FINs RVS CTR MTG BAR	Z	S	6	9	BH BH	6 9/16 6 9/16	45 1/2 45 1/2	C C	40 40	F F	F	225877
45 1/2	42 1/2	4 1/2	CATERPILLAR	D-8H HVY T/BTM HDRS SGL CTR MTG BAR BRASS FINs	B	B	6	7	BH BH	6 9/16 6 9/16	45 1/2 45 1/2	C C	40 40	F F	F	229617
45 1/2	42 1/2	4 1/2	CATERPILLAR	D-8H HVY T/BTM HDRS RVS CTR MTG BAR BRASS FINs	B	B	6	7	BH BH	6 5/8 6 5/8	45 1/2 45 1/2	C C	40 40	F F	F	229618
45 1/2	42 1/2	4 1/2	CATERPILLAR	D-8H HVY T/BTM HDRS RVS CTR MTG BAR BRASS FINs FACE DIPPED	B	B	6	7	BH BH	6 9/16 6 9/16	45 1/2 45 1/2	C C	40 40	F F	F	229619
45 1/2	42 3/4	4 1/2	CATERPILLAR	D-8H 8S2639 HVY T/BTM HDRS BRASS FINs RVS CTR MTG BAR	T	B	6	7	BH BH	6 9/16 6 9/16	45 1/2 45 1/2	C C	40 40	F F	F	223071
45 1/2	45	4 7/16	CATERPILLAR	D-8K 6N880 HVY T/BTM HDRS BRASS FINs 4 CRNRS NOTCHED RVS CTR MTG BAR	Z	B	6	9	BH BH	8 8	46 5/8 46 5/8	C C	42 42	F F	F	225155
45 1/2	45	4 1/2	CATERPILLAR	D-8K 6N880 HVY T/BTM HDRS BRASS FINs RVS CTR MTG BAR 4 CRNRS OF CORE NOTCHED	T	B	6	7	BH BH	8 8	46 5/8 46 5/8	C C	42 42	F F	F	265580
45 1/2	45	6	CATERPILLAR	D-8K 6N957 HVY T/BTM HDRS BRASS FINs RVS CTR MTG BAR 4 CRNRS OF CORE NOTCHED	T	B	8	7	BH BH	8 8	46 5/8 46 5/8	C C	42 42	F F	F	223115
45 1/2	45	6	CATERPILLAR	D-8K 6N957 HVY T/BTM HDRS BRASS FINs 4 CRNRS NOTCHED RVS CTR MTG BAR	Z	B	8	9	BH BH	8 8	46 5/8 46 5/8	C C	42 42	F F	F	225121
45 1/2	45	6	CATERPILLAR	D-8K 6N957 HVY T/BTM HDRS HVY STEEL FINs 4 CRNRS NOTCHED RVS CTR MTG BAR	Z	S	8	9	BH BH	8 8	46 5/8 46 5/8	C C	42 42	F F	F	225871
45 1/2	45	6	CATERPILLAR	D-8K 6N957 HVY T/BTM HDRS RVS CTR MTG BAR BRASS FINs FACE DIPPED 4 CRNRS NOTCHED	B	B	8	7	BH BH	8 8	46 5/8 46 5/8	C C	42 42	F F	F	229509
45 1/2	45	6	CATERPILLAR	D-8K 6N957 HVY T/BTM HDRS RVS CTR MTG BAR BRASS FINs 4 CRNRS NOTCHED	B	B	8	7	BH BH	8 8	46 5/8 46 5/8	C C	42 42	F F	F	229615
45 1/2	45	6	CATERPILLAR	D-8K 6N957 HVY T/BTM HDRS RVS CTR MTG BAR BRASS FINs FACE DIPPED 4 CRNRS NOTCHED	B	B	8	7	BH BH	8 8	46 5/8 46 5/8	C C	42 42	F F	F	229616
45 3/4	25 5/8	3 11/16	CATERPILLAR	973 1W6833 HVY T/BTM HDRS 4 CRNRS OF CORE NOTCHED	Z	C	5	9	BH BH	9 13/16 9 13/16	28 1/16 28 1/16	C C	34 34	F F	C	225229
45 3/4	25 5/8	3 11/16	CATERPILLAR	973 1W6833 HVY T/BTM HDRS HVY STEEL FINs 4 CRNRS OF CORE NOTCHED	Z	S	5	9	BH BH	9 13/16 9 13/16	28 1/16 28 1/16	C C	34 34	F F	C	225928
45 3/4	25 5/8	4 7/16	CATERPILLAR	973 LOADER 8N9135 HVY T/BTM HDRS BRASS FINs 4 CRNRS OF CORE NOTCHED	Z	B	6	9	BH BH	9 13/16 9 13/16	28 1/16 28 1/16	C C	34 34	F F	C	225191
45 3/4	25 5/8	4 7/16	CATERPILLAR	973 LOADER 8N9135 HVY T/BTM HDRS HVY STEEL FINs 4 CRNRS OF CORE NOTCHED	Z	S	6	9	BH BH	9 13/16 9 13/16	28 1/16 28 1/16	C C	34 34	F F	C	225868

Vista-Pro Automotive - Core Catalog
(Cores Sorted by Size)

Height	Width	Depth	Application	Description	Fin Type	Fin Matl	Rows	FPI	BH / TH Type	BH / TH Width	BH / TH Length	BH / TH OHF	BH / TH Bolts	BH / TH Shape	Hdr Support	Model #
45 3/4	25 5/8	5 3/16	CATERPILLAR	973 8N6492 HVY T/BTM HDRS BRASS FINS 4 CRNRS OF CORE NOTCHED	Z	B	7	9	BH BH	9 13/16 9 13/16	28 1/16 28 1/16	C C	34 34	F F	C C	225228
45 3/4	25 5/8	5 3/16	CATERPILLAR	973 8N6492 HVY T/BTM HDRS HVY STEEL FINS 4 CRNRS OF CORE NOTCHED	Z	S	7	9	BH BH	9 13/16 9 13/16	28 1/16 28 1/16	C C	34 34	F F	C C	225948
45 3/4	25 7/8	3 3/4	CATERPILLAR	973 HVY T/BTM HDRS 4 CRNRS OF CORE NOTCHED	T	C	5	10	BH BH	9 15/16 9 15/16	28 1/8 28 1/8	C C	34 34	F F	C C	266493
45 3/4	25 7/8	4 1/2	CATERPILLAR	973 HVY T/BTM HDRS HVY STEEL FINS 4 CRNRS OF CORE NOTCHED	T	S	6	9	BH BH	9 13/16 9 13/16	28 1/16 28 1/16	C C	34 34	F F	C C	266474
46	28 11/16	3	CHEV/GMC	ASTRO TEMPLATE #9	T	C	4	10	BL BL	10 3/8 6 7/8	31 1/4 31 1/4	1 1/2 1 1/2	46 42	A A	C C	265401
46	28 3/4	2 7/8	CHEV/GMC	ASTRO HVY BTM HDR TEMPLATE #9	R	C	5	10	BL BH	10 3/8 6 7/8	31 1/4 31 1/4	1 1/2 1 1/2	46 42	A A	C C	226333
46	32 1/16	5 1/4	LIFT TRUCKS & LOADERS	MICHIGAN HVY T/BTM HDRS	T	C	7	9	BH BH	9 1/8 7 7/8	36 36	C C	48 48	A A	C C	266584
46	45	5 3/16	CATERPILLAR	641, 651, 660, 666 HVY T/BTM HDRS BRASS FINS	Z	B	7	8	BH BH	8 8	47 7/16 47 7/16	C C	46 46	F F	CC CC	225400
46	45 1/2	5 1/4	CATERPILLAR	641, 651, 660, 666 HVY T/BTM HDRS BRASS FINS	B	B	7	7	BH BH	8 8	47 7/16 47 7/16	C C	46 46	F F	CC CC	229620
46	46 1/4	2 7/8	JOY MANUFACTURING	HVY BTM HDR	R	C	5	10	BL BH	5 7/8 5 7/8	48 48	C C	56 56	A A	CC CC	226532
46	47 1/2	2 3/8	INGERSOLL-RAND	HVY BTM HDR	R	C	4	8	BL BH	6 6	49 7/8 49 7/8	C C	62 62	A A	CC CC	226520
46	66 3/8	4 1/2	EUCLID	R-85 HAUL TRUCK 4094492 HVY T/BTM HDRS	T	C	6	8	BH BH	8 1/2 8 1/2	70 1/4 70 1/4	C C	68 68	A A	CC CC	223595
46 1/2	48 1/8	6	CATERPILLAR	834, 835 9S6156 HVY T/BTM HDRS HVY STEEL FINS 4 CRNRS OF CORE NOTCHED	Z	S	8	9	BH BH	8 8	49 1/2 49 1/2	C C	46 46	A A	CC CC	225914
47 1/4	43 3/4	5 3/16	KOMATSU	D-155A 175-03-32260 HVY T/BTM HDRS BRASS FINS	Z	B	7	9	BH BH	8 1/4 8 1/4	46 3/4 46 3/4	C C	52 52	A A	CC CC	225621
47 1/4	43 3/4	5 3/16	KOMATSU	D-155A 175-03-32260 HVY T/BTM HDRS HVY STEEL FINS	Z	S	7	9	BH BH	8 1/4 8 1/4	46 3/4 46 3/4	C C	52 52	A A	CC CC	225925
47 1/4	44	5 1/4	KOMATSU	D-155 HVY T/BTM HDRS	B	C	7	7	BH BH	8 1/4 8 1/4	46 3/4 46 3/4	C C	52 52	A A	CC CC	229574
47 1/2	40	6	CATERPILLAR	5Z5933 HVY T/BTM HDRS BRASS FINS CTR SUPPORT FINS	Z	B	8	6	BH BH	9 11/16 9 11/16	45 7/8 45 7/8	C C	52 52	A A	C C	225537
47 1/2	43 1/8	5 3/16	CATERPILLAR	D-8L 7N3112 HVY T/BTM HDRS BRASS FINS CTR SUPPORT FINS	Z	B	7	9	BH BH	9 11/16 9 11/16	45 7/8 45 7/8	C C	52 52	A A	CC CC	225178
47 1/2	43 1/8	5 3/16	CATERPILLAR	D-8L 7N3112 HVY T/BTM HDRS HVY STEEL FINS CTR SUPPORT FINS	Z	S	7	9	BH BH	9 11/16 9 11/16	45 7/8 45 7/8	C C	52 52	A A	F F	225854
47 1/2	43 5/16	5 1/4	CATERPILLAR	D-8L HVY T/BTM HDR HVY STEEL FINS	T	S	7	9	BH BH	9 11/16 9 11/16	45 7/8 45 7/8	C C	52 52	A A	CC CC	266466
47 1/2	43 1/2	5 1/4	CATERPILLAR	D-8L HVY T/BTM HDRS CTR SUPPORT FINS BRASS FINS FACE DIPPED	B	B	7	7	BH BH	9 11/16 9 11/16	45 7/8 45 7/8	C C	52 52	A A	CC CC	229561
47 1/2	43 1/2	5 1/4	CATERPILLAR	D-8L HVY T/BTM HDRS CTR SUPPORT FINS BRASS FINS	B	B	7	7	BH BH	9 11/16 9 11/16	45 7/8 45 7/8	C C	52 52	A A	F F	229621
47 1/2	43 3/4	4 7/16	CATERPILLAR	973 8N2343 HVY T/BTM HDRS HVY STEEL FINS CTR SUPPORT FINS	Z	S	6	9	BH BH	8 7/8 8 7/8	46 3/4 46 3/4	C C	48 48	A A	CC CC	225915
47 7/8	40 1/2	4 1/2	DRESSER INDUSTRIES	HOUGH 560 HVY T/BTM HDRS	B	C	6	8	BH BH	8 1/2 8 1/2	42 1/2 42 1/2	C C	54 54	A A	CC CC	279339
48	27 1/2	2 7/8	INGERSOLL-RAND	COMPRESSOR 5 STIFFENING HOLES T/HDR	R	C	5	9	BL BL	10 1/4 6 1/8	29 7/16 29 7/16	1 13/16 1 1/2	44 40	A A	C C	226521
48	37 1/2	4 7/16	MANITOWOC	3600 CRANE HVY BTM HDR BRASS FINS	Z	B	6	8	BL BH	8 1/4 8 1/4	40 1/4 40 1/4	C C	50 50	A A	C C	289570
48	37 1/2	5 3/16	MANITOWOC	3900 CRANE HVY T/BTM HDRS BRASS FINS	Z	B	7	9	BH BH	8 1/4 8 1/4	40 1/4 40 1/4	C C	50 50	A A	C C	286856
48	37 11/16	4 1/2	MANITOWOC	3600 CRANE HVY T/BTM HDRS	T	C	6	8	BH BH	8 1/4 8 1/4	40 1/4 40 1/4	C C	50 50	A A	C C	278428

Vista-Pro Automotive - Core Catalog
(Cores Sorted by Size)

Height	Width	Depth	Application	Description	Fin Type	Fin Matl	Rows	FPI	BH / TH Type	BH / TH Width	BH / TH Length	BH / TH OHF	BH / TH Bolts	BH / TH Shape	Hdr Support	Model #
48	48 1/8	3 15/16	OSHKOSH TRUCK	FIRE TRUCK 3552-00506	S	C	7	10	BL	8 1/8	50 1/2	1 3/4	66	A	CC	229137
									BL	8 1/8	50 1/2	1 3/4	66	A		
48	48 3/8	5 1/4	DETROIT DIESEL	DRILL ENGINE HVY T/BTM HDRS	T	C	7	9	BH	8 3/4	50 1/2	C	58	A	CC	272867
									BH	8 3/4	50 1/2	C	58	A		
48	47 13/16	4 1/2	OSHKOSH		T	B	6	10	BH	8 1/8	50 1/2	1 3/4	66	A	F	269137
									BH	8 1/8	50 1/2	1 3/4	66	A		
48 1/8	48 1/8	3 7/16	CUMMINS/DETROIT		R	C	6	11	BH	7 1/8	51	C	58	A	CC	226856
									BH	7 1/8	51	C	58	A		
48 1/4	47 1/4	5 1/4	CATERPILLAR	637 SCRAPER HVY T/BTM HDRS HVY STEEL FINS	T	S	7	7	BH	8 7/8	49 7/8	1 1/2	50	A	CC	266363
									BH	8 7/8	49 7/8	1 1/2	50	A		
48 1/4	47 1/2	4 7/16	CATERPILLAR	988B 7N1097 HVY T/BTM HDRS HVY STEEL FINS	Z	S	6	9	BH	8 7/8	49 7/8	C	50	A	F	225821
									BH	8 7/8	49 7/8	C	50	A		
48 1/4	47 1/2	5 3/16	CATERPILLAR	631D, 633D, 637D 7N9314 HVY T/BTM HDRS BRASS FINS SGL CTR MTG BAR	Z	B	7	9	BH	8 7/8	49 7/8	1 1/2	50	A	F	225193
									BH	8 7/8	49 7/8	1 1/2	50	A		
48 1/4	47 1/2	5 3/16	CATERPILLAR	631D, 633D, 637D 7N9314 HVY T/BTM HDRS HVY STEEL FINS SGL CTR MTG BAR	Z	S	7	9	BH	8 7/8	49 7/8	1 1/2	50	A	F	225829
									BH	8 7/8	49 7/8	1 1/2	50	A		
48 1/4	47 1/2	5 1/4	CATERPILLAR	631 SCRAPER HVY T/BTM HDRS SGL CTR MTG BAR BRASS FINS FACE DIPPED	B	B	7	7	BH	8 7/8	49 7/8	C	50	A	F	272593
									BH	8 7/8	49 7/8	C	50	A		
48 1/4	47 1/2	6	CATERPILLAR	988B 4N9691 HVY T/BTM HDRS BRASS FINS	Z	B	8	9	BH	8 7/8	49 7/8	C	50	A	F	225143
									BH	8 7/8	49 7/8	C	50	A		
48 1/4	47 1/2	6	CATERPILLAR	637 SCRAPER 4N7241 HVY T/BTM HDRS BRASS FINS	Z	B	8	9	BH	8 3/4	49 7/8	C	48	A	CC	225401
									BH	8 3/4	49 7/8	C	48	A		
48 1/4	47 1/2	6	CATERPILLAR	988B 4N9691 HVY T/BTM HDRS HVY STEEL FINS	Z	S	8	9	BH	8 7/8	49 7/8	C	50	A	F	225855
									BH	8 7/8	49 7/8	C	50	A		
48 1/4	47 1/2	6	CATERPILLAR	631, 633, 637 SCRAPER HVY T/BTM HDRS BRASS FINS FACE DIPPED	B	B	8	7	BH	8 7/8	49 7/8	C	48	A	CC	229547
									BH	8 7/8	49 7/8	C	48	A		
48 1/4	47 1/2	6	CATERPILLAR	988B LOADER HVY T/BTM HDRS BRASS FINS FACE DIPPED	B	B	8	7	BH	8 7/8	49 7/8	C	50	A	CC	229565
									BH	8 7/8	49 7/8	C	50	A		
48 1/4	47 1/2	6	CATERPILLAR	631, 633, 637 SCRAPER HVY T/BTM HDRS BRASS FINS	B	B	8	7	BH	8 7/8	49 7/8	C	48	A	CC	229622
									BH	8 7/8	49 7/8	C	48	A		
48 1/4	47 1/2	6	CATERPILLAR	988B LOADER HVY T/BTM HDRS BRASS FINS	B	B	8	7	BH	8 7/8	49 7/8	C	50	A	CC	229623
									BH	8 7/8	49 7/8	C	50	A		
48 1/4	47 13/16	6	CATERPILLAR	988B HVY T/BTM HDRS BRASS FINS FACE DIPPED	T	B	8	7	BH	8 7/8	49 7/8	C	50	A	CC	272606
									BH	8 7/8	49 7/8	C	50	A		
48 1/4	63 9/16	3 3/4	SCHRAMM	ROTARY DRILL HVY T/BTM HDRS	T	C	5	11	BH	6 3/4	66 1/2	C	72	A	CC	272942
									BH	6 3/4	66 1/2	C	72	A		
48 5/16	47 1/2	4 7/16	CATERPILLAR	988B 4W4987 HVY T/BTM HDRS BRASS FINS CTR SUPPORT FINS	Z	B	6	9	BH	8 7/8	49 7/8	C	50	A	CC	225065
									BH	8 7/8	49 7/8	C	50	A		
48 5/16	47 1/2	4 7/16	CATERPILLAR	988B 4W4987 HVY T/BTM HDRS HVY STEEL FINS CTR SUPPORT FINS	Z	S	6	9	BH	8 7/8	49 7/8	C	50	A	CC	225947
									BH	8 7/8	49 7/8	C	50	A		
48 5/16	47 1/2	5 3/16	CATERPILLAR	769C 4W4986 HVY T/BTM HDRS BRASS FINS CTR SUPPORT FINS	Z	B	7	9	BH	8 7/8	49 7/8	C	50	A	F	225075
									BH	8 7/8	49 7/8	C	50	A		
48 5/16	47 1/2	5 3/16	CATERPILLAR	769C 4W4986 HVY T/BTM HDRS HVY STEEL FINS CTR SUPPORT FINS	Z	S	7	9	BH	8 7/8	49 7/8	C	50	A	CC	225918
									BH	8 7/8	49 7/8	C	50	A		
48 5/16	47 1/2	5 1/4	CATERPILLAR	769C 35 TON HAUL TRUCK HVY T/BTM HDRS CTR SUPPORT FINS BRASS FINS	B	B	7	7	BH	8 7/8	49 7/8	C	50	A	CC	229566
									BH	8 7/8	49 7/8	C	50	A		
48 5/16	47 1/2	6	CATERPILLAR	1W6861 HVY T/BTM HDRS BRASS FINS CTR SUPPORT FINS	Z	B	8	9	BH	8 7/8	49 7/8	C	50	A	F	225066
									BH	8 7/8	49 7/8	C	50	A		
48 1/2	36 7/8	5 3/16	LIFT TRUCKS & LOADERS	MICHIGAN HVY T/BTM HDRS BRASS FINS	Z	B	7	9	BH	9 1/4	40	C	52	A	CC	282709
									BH	8 1/4	40	C	52	A		
48 1/2	37 1/8	5 1/4	V.M.E.	MICHIGAN 275 HVY T/BTM HDRS	T	C	7	8	BH	9 1/4	40	C	52	A	C	223310
									BH	8 1/4	40	C	52	A		
48 5/8	34 3/8	1 3/4	FORD TRUCK	CL9000	R	C	3	11	BL	5 1/2	37	C	48	A	C	226119
									BL	5 1/2	37	C	48	A		

Vista-Pro Automotive - Core Catalog
(Cores Sorted by Size)

Height	Width	Depth	Application	Description	Fin Type	Fin Matl	Rows	FPI	BH / TH Type	BH / TH Width	BH / TH Length	BH / TH OHF	BH / TH Bolts	BH / TH Shape	Hdr Support	Model #
49 3/4	33 3/4	3 3/4	JOHN DEERE	8850 AT10345 HVY T/BTM HDRS	T	C	5	8	BH BH	7 1/2 7 1/2	35 35	C C	44 44	A A	C C	272905
49 3/4	43 3/4	5 3/16	LINK-BELT	HVY T/BTM HDRS BRASS FINS	Z	B	7	10	BH BH	8 1/4 8 1/4	47 47	C C	58 58	A A	CC CC	282482
50	37 1/2	6	CATERPILLAR	983 7S2538 HVY T/BTM HDRS HVY STEEL FINS	Z	S	8	9	BH BH	8 1/4 8 1/4	38 3/4 38 3/4	C C	38 38	A A	F F	225866
50	48 3/8	3 3/4	CATERPILLAR	HVY T/BTM HDRS	T	C	5	9	BH BH	7 1/4 7 1/4	50 50	C C	58 58	A A	CC CC	272816
50	49 1/2	5 1/4	CATERPILLAR	D353 3408 STATIONARY HVY T/BTM HDRS	T	C	7	10	BH BH	7 1/2 7 1/2	51 3/4 51 3/4	C C	62 62	A A	CC CC	272814
50	50	4 7/16	DETROIT DIESEL	HVY T/BTM HDRS BRASS FINS	Z	B	6	9	BH BH	9 1/8 9 1/8	52 5/8 52 5/8	2 1/2 2 1/2	66 66	A A	CC CC	281651
50	50 1/16	3 3/4	DETROIT DIESEL	HVY T/BTM HDRS	T	C	5	8	BH BH	9 1/8 9 1/8	52 1/2 52 1/2	2 3/8 2 3/8	66 66	A A	CC CC	272655
50	50 1/16	4 1/2	DETROIT DIESEL	HVY T/BTM HDRS	T	C	6	8	BH BH	9 1/4 9 1/4	52 1/4 52 1/4	C C	62 62	A A	CC CC	223097
50	50 1/16	4 1/2	DETROIT DIESEL	V-16 HVY T/BTM HDRS	T	C	6	8	BH BH	9 1/8 9 1/8	52 1/2 52 1/2	C C	66 66	A A	CC CC	272656
50	50 1/16	4 1/2	DETROIT DIESEL	HVY T/BTM HDRS 4 CRNRS OF CORE NOTCHED	T	C	6	8	BH BH	8 8	50 50	C C	56 56	A A	CC CC	272871
50	52 1/2	3 7/16	INGERSOLL-RAND	1200 CFM HVY T/BTM HDRS	R	C	6	11	BH BH	6 6	53 7/8 53 7/8	C C	66 66	A A	CC CC	226523
50	62 7/16	2 1/4	GARDNER DENVER	DETROIT DIESEL ENGINE HVY T/BTM HDRS	T	C	3	9	BH BH	7 7	67 67	C C	76 76	A A	CC CC	223311
50 3/8	47 1/2	5 1/4	KOMATSU	D-355 HVY T/BTM HDRS SGL CTR MTG BAR	B	C	7	7	BH BH	8 1/4 8 1/4	49 1/2 49 1/2	C C	52 52	F F	CC CC	229557
50 3/4	35	4 7/16	WAUKESHA	WAK BRASS FINS W/ BRASS CTR TANK	Z	B	6	9	BL BL	9 1/4 9 1/4	39 1/2 39 1/2	1 5/8 1 5/8	42 42	A A	C C	289877
50 3/4	50 5/8	5 3/16	CAT-LEMASTER	3412 GEN SET REPL 11 CORES BRASS FINS	Z	B	7	8	BH BH	7 7	51 51	C C	60 60	0 0	CC CC	284276
50 3/4	50 5/8	5 3/16	CAT-LEMASTER	651E 657E FRONT 4W/2786 GROUP REPL 16 CORES BRASS FINS	Z	B	7	7	BH BH	7 7	50 1/2 50 1/2	C C	60 60	A A	CC CC	284158
50 3/4	51 3/4	5 1/4	CAT-LEMASTER	D-10N w/IRM 4Q5657 GROUP REPL 11 CORES BRASS FINS	T	B	7	7	BH BH	7 7	52 52	C C	58 58	0 0	CC CC	274282
50 3/4	51 7/8	5 3/16	CAT-LEMASTER	D-10N w/IRM 4Q5657 GROUP REPL 11 CORES BRASS FINS	Z	B	7	7	BH BH	7 7	52 52	C C	58 58	0 0	CC CC	284282
50 3/4	52 1/2	5 3/16	CAT-LEMASTER	D-10N W/AC REPL 16 CORES BRASS FINS	Z	B	7	7	BH BH	7 7	53 53	C C	60 60	0 0	CC CC	284110
50 3/4	52 1/2	5 3/16	CAT-LEMASTER	D-10N W/AC REPL 19 CORES BRASS FINS	Z	B	7	7	BH BH	7 7	52 1/2 52 1/2	C C	60 60	0 0	CC CC	284136
50 3/4	52 7/8	5 1/4	CAT-LEMASTER	D-10N W/AC REPL 19 CORES BRASS FINS	T	B	7	7	BH BH	7 7	52 1/2 52 1/2	C C	60 60	0 0	CC CC	274136
51	47 13/16	3 3/4	CATERPILLAR	3412 GEN SET HVY T/BTM HDRS	T	C	5	9	BH BH	13 9	50 50	2 1/4 2 1/4	54 50	A A	F A	223072
51	47 13/16	4 1/2	CATERPILLAR	3412 GEN SET HVY T/BTM HDRS	T	C	6	9	BH BH	13 9	50 50	2 1/4 2 1/4	54 50	A A	CC A	223073
51	48 1/8	3 11/16	CATERPILLAR	3412 4N9995 HVY BTM HDR BRASS FINS REINFORCED T/HDR	Z	B	5	9	BH BH	13 9	50 50	2 1/4 2 1/4	54 50	A A	F A	225404
51	48 1/8	4 7/16	CATERPILLAR	3412 GEN SET 8N4885 HVY BTM HDR BRASS FINS REINFORCED T/HDR	Z	B	6	9	BH BH	13 9	50 50	2 1/4 2 1/4	54 50	A A	F A	225200
51	51 3/16	3 3/4	JOY MANUFACTURING	HVY T/BTM HDRS	T	C	5	8	BH BH	7 1/4 7 1/4	54 54	C C	62 62	A A	CC CC	223312
51	52 1/2	4 1/2	FIAT ALLIS	HD-41 HVY T/BTM HDRS 1 7/8" SPACE BTWN CORES	B	C	6	9	BH BH	8 1/4 8 1/4	55 1/2 55 1/2	C C	70 70	A A	CC CC	229554
51	60	4 7/16	CATERPILLAR	HVY T/BTM HDRS BRASS FINS	Z	B	6	9	BH BH	8 1/8 8 1/8	62 62	C C	74 74	A A	F A	225181
51 1/4	46 1/4	5 3/16	CATERPILLAR	D-9G, 9S9022 HVY T/BTM HDRS BRASS FINS SGL CTR MTG BAR	Z	B	7	9	BH BH	6 7/8 6 7/8	48 1/2 48 1/2	C C	44 44	F F	F F	225069
51 1/4	46 1/4	6	CATERPILLAR	D-9H, 6N973 HVY T/BTM HDRS BRASS FINS RVS CTR MTG BAR	Z	B	8	9	BH BH	8 8	49 49	C C	44 44	F F	F F	225085

Vista-Pro Automotive - Core Catalog
(Cores Sorted by Size)

Height	Width	Depth	Application	Description	Fin Type	Fin Matl	Rows	FPI	BH / TH Type	BH / TH Width	BH / TH Length	BH / TH OHF	BH / TH Bolts	BH / TH Shape	Hdr Support	Model #
51 1/4	46 1/4	6	CATERPILLAR	D-9H, 6N973 HVY T/BTM HDRS HVY STEEL FINS RVS CTR MTG BAR	Z	S	8	9	BH BH	8 8	49 49	C	44	F	F	225822
51 1/4	46 1/2	6	CATERPILLAR	D-9H 6N973 HVY T/BTM HDRS RVS CTR MTG BAR BRASS FINS FACE DIPPED	B	B	8	7	BH BH	8 8	49 49	C	44	F	F	229548
51 1/4	46 1/2	6	CATERPILLAR	D-9H 6N973 HVY T/BTM HDRS RVS CTR MTG BAR BRASS FINS	B	B	8	7	BH BH	8 8	49 49	C	44	F	F	229624
52	51	4 1/2	CATERPILLAR	641B, 651B SCRAPER 1P6101 HVY T/BTM HDRS BRASS FINS	B	B	6	7	BH BH	8 8	54 3/8 54 3/8	C	54	F	CC	229626
52	51	6	CATERPILLAR	773 6N9376 HVY T/BTM HDRS BRASS FINS FACE DIPPED	B	B	8	7	BH BH	8 8	54 3/8 54 3/8	C	54	F	CC	229569
52	51 3/16	4 1/2	CATERPILLAR	641, 651 SCRAPER HVY T/BTM HDRS BRASS FINS	T	B	6	8	BH BH	8 8	54 3/8 54 3/8	C	50	F	CC	265027
52	51 1/4	4 7/16	CATERPILLAR	641B, 651B, 657B 1P6101 HVY T/BTM HDRS BRASS FINS	Z	B	6	9	BH BH	8 8	54 3/8 54 3/8	C	54	F	F	225053
52	51 1/4	4 7/16	CATERPILLAR	641B, 651B, 657B 1P6101 HVY T/BTM HDRS HVY STEEL FINS	Z	S	6	9	BH BH	8 8	54 3/8 54 3/8	C	54	F	F	225856
52	51 1/4	6	CATERPILLAR	773 HAUL TRUCK 6N9376 HVY T/BTM HDRS BRASS FINS	Z	B	8	9	BH BH	8 8	54 3/8 54 3/8	C	54	F	CC	225145
52 1/8	51 1/4	4 7/16	CATERPILLAR	641B, 651B, 657B 7N3694 HVY T/BTM HDRS BRASS FINS CTR SUPPORT FINS	Z	B	6	9	BH BH	8 8	54 3/8 54 3/8	C	50	F	CC	225054
52 1/8	51 1/4	4 7/16	CATERPILLAR	641B, 651B, 657B 7N3694 HVY T/BTM HDRS HVY STEEL FINS CTR SUPPORT FINS	Z	S	6	9	BH BH	8 8	54 3/8 54 3/8	C	50	F	CC	225930
53 3/8	52 1/2	4 7/16	CUMMINS ENGINE	V-12 3001576 HVY BTM HDR BRASS FINS	Z	B	6	9	BL BH	10 1/4 10 1/4	55 3/8 55 3/8	2	64	A	CC	225437
54	48 15/16	3 3/4	CUMMINS ENGINE	V-12 HVY T/BTM HDRS	T	C	5	8	BH BH	7 7	50 7/8 50 7/8	C	62	A	CC	272493
54	53 1/8	4 7/16	CUMMINS ENGINE	POWER UNIT HVY BTM HDR BRASS FINS	Z	B	6	10	BL BH	7 3/8 7 3/8	55 5/8 55 5/8	C	64	A	CC	225439
54 1/8	50 5/8	5 3/16	CATERPILLAR	D-9L 7N2191 HVY T/BTM HDRS BRASS FINS CTR SUPPORT FINS	Z	B	7	9	BH BH	9 9/16 9 9/16	53 1/2 53 1/2	C	56	A	CC	225192
54 1/8	50 5/8	5 3/16	CATERPILLAR	D-9L 7N2191 HVY T/BTM HDRS HVY STEEL FINS CTR SUPPORT FINS	Z	S	7	9	BH BH	9 9/16 9 9/16	53 1/2 53 1/2	C	56	A	F	225878
54 1/8	50 5/8	6	CATERPILLAR	773B HAUL TRUCK 8N66 HVY T/BTM HDRS BRASS FINS CTR SUPPORT FINS	Z	B	8	9	BH BH	9 9/16 9 9/16	53 1/2 53 1/2	C	56	A	CC	225225
54 1/8	51	5 1/4	CATERPILLAR	D-9L HVY T/BTM HDRS CTR SUPPORT FINS BRASS FINS FACE DIPPED	B	B	7	7	BH BH	9 9/16 9 9/16	53 1/2 53 1/2	C	56	A	CC	229511
54 1/8	51	5 1/4	CATERPILLAR	D-9L HVY T/BTM HDRS CTR SUPPORT FINS BRASS FINS FACE DIPPED	B	B	7	7	BH BH	9 5/8 9 5/8	53 1/2 53 1/2	C	56	A	F	229628
54 1/8	51	6	CATERPILLAR	773B 50 TON HAUL TRUCK 8N66 HVY T/BTM HDRS CTR SUPPORT FINS BRASS FINS FACE DIPPED	B	B	8	7	BH BH	9 5/8 9 5/8	53 1/2 53 1/2	C	56	A	CC	229582
54 1/8	51	6	CATERPILLAR	773B 50 TON HAUL TRUCK 8N66 HVY T/BTM HDRS CTR SUPPORT FINS BRASS FINS FACE DIPPED	B	B	8	7	BH BH	9 9/16 9 9/16	53 1/2 53 1/2	C	56	A	F	229629
54 1/8	51 3/16	5 1/4	CATERPILLAR	D-9L HVY T/BTM HDRS CTR SUPPORT FINS	T	C	7	9	BH BH	9 9/16 9 9/16	53 1/2 53 1/2	C	56	A	CC	266371
54 1/8	55 1/8	4 1/2	MANITOWOC	HVY T/BTM HDRS	T	C	6	10	BH BH	8 1/4 8 1/4	57 1/2 57 1/2	C	66	A	CC	223271
54 1/2	54 3/8	4 7/16	INGERSOLL-RAND	DM30 ROCK DRILL HVY T/BTM HDRS BRASS FINS	Z	B	6	9	BH BH	7 1/8 7 1/8	57 57	C	64	A	CC	285209
56 1/8	36 1/4	6	MANITOWOC	DRAG LINE HVY T/BTM HDR BRASS FINS	Z	B	8	8	BH BH	10 10	39 1/8 39 1/8	C	50	A	C	282499
57 7/8	60	5 3/16	CAT-L6MASTER	3508, 3512 GEN SET 7W3699 REPL 13 CORES BRASS FINS	Z	B	7	7	BH BH	7 7	60 1/2 60 1/2	C	68	0	CC	284264
57 7/8	60	5 3/16	CAT-L6MASTER	D-11N 8N8702 GROUP REPL 21 CORES BRASS FINS	Z	B	7	7	BH BH	7 7	60 1/2 60 1/2	C	68	0	CC	284100

Vista-Pro Automotive - Core Catalog
(Cores Sorted by Size)

Height	Width	Depth	Application	Description	Fin Type	Fin Matl	Rows	FPI	BH / TH Type	BH / TH Width	BH / TH Length	BH / TH OHF	BH / TH Bolts	BH / TH Shape	Hdr Support	Model #
58	55 5/8	5 3/16	CAT-LeMASTER	988F LOADER w/IRRM 4P2488 GROUP REPL 12 CORES BRASS FINS	Z	B	7	7	BH BH	7 7	56 56	C	62 62	A A	CC	284168
58	56 1/4	5 1/4	CAT-LeMASTER	988F LOADER w/IRRM 4P2488 GROUP REPL 12 CORES BRASS FINS	T	B	7	7	BH BH	7 7	56 56	C	62 62	0 0	CC	274168
58 1/2	57 1/2	2 3/16	CATERPILLAR	777 AFTERCOOLER 6N1939 HVY T/BTM HDRS HVY STEEL FINS	Z	S	3	9	BH BH	6 1/2 6 1/2	59 7/8 59 7/8	C	54 54	A A	CC	225946
58 1/2	57 1/2	6	CATERPILLAR	777 85 TON TRUCK 6N9377 HVY T/BTM HDRS BRASS FINS	Z	B	8	9	BH BH	8 3/4 8 3/4	59 7/8 59 7/8	C	56 56	A A	F	225161
58 1/2	57 1/2	6	CATERPILLAR	777 85 TON TRUCK HVY T/BTM HDRS BRASS FINS FACE DIPPED	B	B	8	7	BH BH	8 3/4 8 3/4	59 7/8 59 7/8	C	56 56	A A	F	272609
58 5/8	57 3/8	6	CATERPILLAR	992C HVY T/BTM HDRS BRASS FINS RVS CTR MTG BAR	T	B	8	7	BH BH	9 3/8 9 3/8	59 7/8 59 7/8	C	58 58	A A	F	266449
58 5/8	57 1/2	5 3/16	CATERPILLAR	D-10 7N9061 HVY T/BTM HDRS BRASS FINS RVS CTR MTG BAR	Z	B	7	9	BH BH	9 3/8 9 3/8	59 7/8 59 7/8	C	58 58	A A	F	225166
58 5/8	57 1/2	5 3/16	CATERPILLAR	D-10 7N9061 HVY T/BTM HDRS HVY STEEL FINS RVS CTR MTG BAR	Z	S	7	9	BH BH	9 3/8 9 3/8	59 7/8 59 7/8	C	58 58	A A	F	225879
58 5/8	57 1/2	6	CATERPILLAR	992C LOADER 6N7661 HVY T/BTM HDRS BRASS FINS RVS CTR MTG BAR	Z	B	8	9	BH BH	9 3/8 9 3/8	59 7/8 59 7/8	C	58 58	A A	F	225226
58 5/8	57 1/2	6	CATERPILLAR	992C LOADER 1N3921 HVY T/BTM HDRS HVY STEEL FINS RVS CTR MTG BAR	Z	S	8	9	BH BH	9 3/8 9 3/8	59 7/8 59 7/8	C	58 58	A A	F	225899
58 5/8	57 1/2	6	CATERPILLAR	992C LOADER 1N3921, 6N7661 HVY T/BTM HDRS BRASS FINS FACE DIPPED	B	B	8	7	BH BH	9 3/8 9 3/8	59 7/8 59 7/8	C	58 58	A A	F	229592
58 5/8	57 1/2	6	CATERPILLAR	992C LOADER 1N3921, 6N7661 HVY T/BTM HDRS BRASS FINS FACE DIPPED RVS CTR MTG BAR	B	B	8	7	BH BH	9 3/8 9 3/8	59 7/8 59 7/8	C	58 58	A A	F	229630
59	55 5/8	5 3/16	LIFT TRUCKS & LOADERS	MICHIGAN HVY T/BTM HDRS BRASS FINS	Z	B	7	9	BH BH	10 1/4 10 1/4	58 3/4 58 3/4	C	72 72	A A	CC	286342
59 1/2	60	4 7/16	CUMMINS ENGINE	GENERATOR SET HVY T/BTM HDRS BRASS FINS	Z	B	6	9	BH BH	8 1/4 8 1/4	63 1/2 63 1/2	C	74 74	A A	CC	225431
60	43 5/16	5 1/4	HALLIBURTON	HVY T/BTM HDRS	T	C	7	8	BH BH	8 3/4 8 3/4	45 1/2 45 1/2	C	54 54	A A	CC	272687
60	53 3/4	4 7/16	DETROIT DIESEL	HVY T/BTM HDRS BRASS FINS	Z	B	6	9	BH BH	8 1/4 8 1/4	56 1/2 56 1/2	2	66 66	A A	CC	225536
60	59 5/8	3	HAPPY YOUNG	HVY T/BTM HDRS	T	C	4	8	BH BH	6 1/2 6 1/2	63 1/4 63 1/4	C	58 58	A A	CC	264320
60	61 1/4	4 7/16	DETROIT DIESEL	HVY BTM HDR BRASS FINS 4 CRNRS OF CORE NOTCHED	Z	B	6	8	BL BH	8 8	62 62	1 3/4 1 3/4	68 68	A A	CC	286554
60	65	2 3/8	INGERSOLL-RAND	HVY T/BTM HDRS	R	C	4	8	BH BH	7 7	67 3/8 67 3/8	C	76 76	A A	CC	226524
60 5/8	58 3/4	3 7/16	FERMONT	FERMONT GENSET X-3159 HVY BTM HDR	R	C	6	11	BL BH	9 9	62 7/8 62 7/8	C	72 72	A A	CC	226235
61 3/4	62 1/2	5 3/16	CAT-LeMASTER	777C 85 TON TRUCK REPL 23 CORES BRASS FINS	Z	B	7	7	BH BH	7 7	63 63	C	70 70	0 0	CC	284186
62 1/4	55 1/2	5 1/4	KOMATSU	D-475 HVY T/BTM HDRS SGL CTR MTG BAR BRASS FINS FACE DIPPED	B	B	7	7	BH BH	8 1/8 8 1/8	55 7/8 55 7/8	C	58 58	A A	F	272916
69 3/8	72	5 1/4	CAT-LeMASTER	785B 130 TON TRUCK REPL 26 CORES BRASS FINS	T	B	7	7	BH BH	7 7	72 72	C	86 86	0 0	CC	274178
69 3/8	78 3/4	5 3/16	CAT-LeMASTER	3512, 3516 GEN SET 7W7666 REPL 25 CORES BRASS FINS	Z	B	7	7	BH BH	7 7	79 79	C	86 86	0 0	CC	284256
69 3/8	78 3/4	5 1/4	CAT-LeMASTER	3512, 3516 GEN SET 7W7666 REPL 25 CORES BRASS FINS	T	B	7	7	BH BH	7 7	79 79	C	86 86	0 0	CC	274256

Core Listings

- By model



Vista-Pro Radiator Core Catalog

(Sort by Model)

Model #	Height	Width	Depth	Application	Model #	Height	Width	Depth	Application
121021	19 7/8	21 7/16	2	GMC	122257	19 13/16	19 1/4	2	GMC
121026	19 7/8	23 5/8	2	GMC	122263	19 3/4	22	2	GMC
121027	19 7/8	23 5/8	2 5/8	GMC	122264	18 7/16	23 5/8	2	FORD
121102	20 3/4	16 13/16	2 1/4	GMC	122265	15 3/16	17 5/8	1 1/4	JEEP
121104	26 3/8	16 13/16	2 1/4	GMC	122268	16 3/8	20 3/8	2	FORD
121107	28 3/8	16 13/16	2 1/4	GMC	122271	20 1/16	25 5/16	2	GMC
121113	28 3/8	19 3/8	2 1/4	GMC	122272	20 3/8	25 5/16	2	GMC
121114	34	19 3/8	2 1/4	GMC	122273	13 3/4	19 13/16	2	AMC
121128	19 1/4	18 7/8	2 1/4	FORD	122274	18 7/16	25 7/8	2	FORD
121130	19 1/4	26 1/16	2 1/4	FORD	122277	15 7/8	25 7/8	2	WILLYS
121149	19 3/4	27 3/8	1 9/16	CHRYSLER	122278	24	17 5/8	2	FORD
121153	25 3/4	21 1/16	2 1/4	CHRYSLER	122279	17 1/4	19 1/4	2	TOYOTA
121154	15 7/8	30 1/4	1 9/16	CHRYSLER	122280	17 3/4	24 3/16	1 1/4	STUDEBAKER
121176	22	25 11/16	2 1/4	CHRYSLER	122281	15 3/16	17 1/16	1 1/4	FORD
121442	22 1/2	18 1/8	2 5/8	GMC	122282	17 3/4	24 3/16	2	STUDEBAKER
122009	19 1/2	17 1/16	2 5/8	LIFT TRUCKS & LOADERS	122283	14 5/8	24 3/16	1 1/4	AMC
122010	17 3/4	20 3/8	2 5/8	LIFT TRUCKS & LOADERS	122285	16 3/4	19 1/4	1 1/4	VALIANT
122028	20 11/16	19 13/16	2	GMC	122286	17 5/8	25 5/16	2	GMC
122029	20 11/16	19 13/16	2 5/8	GMC	122287	16 3/4	18 11/16	1 1/4	VALIANT
122107	28 3/8	16 15/16	2 1/4	MISC	122288	17 7/8	24 3/16	1 1/4	FORD
122113	28 3/8	19 3/8	2 1/4	GMC	122289	20 9/16	17 5/8	1 1/4	FORD
122200	18 1/4	19 13/16	2	GMC	122290	18 5/8	25 5/16	2	GMC
122201	16 7/8	24 3/16	2	AMC	122291	13	18 11/16	1 1/4	NISSAN
122202	18 7/8	24 3/16	2	AMC	122292	18 5/16	23 5/8	2	GMC
122209	14 7/8	24 3/16	2	STUDEBAKER	122294	15 1/2	25 5/16	2	CHEVROLET
122212	20 5/16	22 9/16	2	FORD	122299	12 1/4	23 1/8	1 1/4	GMC
122213	22 1/8	21 7/16	2	GMC	122302	18 3/8	18 11/16	2	FORD
122216	18 1/4	20 3/8	2	FORD	122303	15 1/2	23 1/8	2	GMC
122218	31	26 3/8	2 5/8	NAVISTAR	122304	20 5/16	20 7/8	2	FORD
122221	17 3/4	24 3/16	1 1/4	STUDEBAKER	122305	14 3/4	18 1/8	1 1/4	TOYOTA
122222	26 1/2	25 7/8	2	INTERNATIONAL	122311	20 9/16	17 5/8	2	FORD
122224	19 7/16	19 13/16	2	FORD	122312	14	18 11/16	2	FIAT
122226	17 1/4	22	2	FORD	122313	20 3/4	11 9/16	2	GMC
122227	20 3/8	23 5/8	2	GMC	122317	16 7/8	24 3/16	1 1/4	RAMBLER
122228	17 7/8	24 3/16	1 1/4	FORD	122318	19	22	2	FORD
122229	17 3/4	22	2	GMC	122321	17 3/8	17 1/16	2	FORD
122230	20 3/4	22	2	GMC	122322	22 1/2	20 7/8	2	FORD
122231	18 1/8	22	2	DODGE	122323	14 1/2	18 11/16	1 1/4	AMC
122232	18 7/16	22	2	GMC	122324	21 5/8	20 7/8	2	FORD
122233	16 3/8	23 1/8	1 1/4	FORD	122325	14 5/8	24 3/16	2	AMC
122235	22 7/16	17 5/8	1 1/4	MERCURY	122326	16 7/8	16 15/16	1 9/16	GMC
122236	24 5/8	23 5/8	2	GMC	122327	18	19 1/4	1 1/4	DODGE
122237	18 1/8	22	2	CHRYSLER	122328	18 5/8	18 11/16	2	FORD
122238	20 3/8	23 1/8	2	GMC	122329	16 3/4	18 11/16	2	CHRYSLER
122239	17 5/8	22	1 1/4	CHRYSLER	122330	19 1/2	19 13/16	2	FORD
122241	18 1/2	22	1 1/4	CHRYSLER	122331	14 1/8	18 11/16	2	CHEVROLET
122246	17 7/8	24 3/16	2	FORD	122332	26 3/8	16 15/16	1 9/16	GMC
122247	17 3/4	25 5/16	1 1/4	GMC	122333	21 5/8	20 7/8	2 5/8	FORD
122248	18 1/4	20 3/8	2	FORD	122334	20 5/16	22 9/16	2	FORD
122250	18 7/8	22	2	CHRYSLER	122335	24 3/4	23 5/8	2 5/8	INTERNATIONAL
122251	20	24 3/16	2	FORD	122336	17 3/4	25 5/16	2	GMC
122252	18 7/8	22	2	CHRYSLER	122337	28 1/4	16 15/16	1 9/16	GMC
122253	17 3/4	24 3/16	2	STUDEBAKER	122338	22 7/16	17 5/8	2	FORD
122255	18	19 1/4	2	GMC	122339	13 3/8	17 3/4	1 9/16	BMW
122256	20	24 3/16	2	FORD	122341	16 3/8	23 1/8	2	ISUZU

Vista-Pro Radiator Core Catalog

(Sort by Model)

Model #	Height	Width	Depth	Application	Model #	Height	Width	Depth	Application
122342	18 7/8	22	1 1/4	CHRYSLER	122421	18 7/8	22	2	CHRYSLER
122344	18 1/8	22	1 1/4	PLYMOUTH	122422	16 3/8	17 1/16	1 1/4	FORD
122345	15 1/2	23 1/8	1 1/4	GMC	122423	18 3/8	22	2	CHRYSLER
122347	15 1/2	25 5/16	2	TEMPEST	122424	20	23 5/8	2 5/8	FORD
122348	22 7/16	17 5/8	1 1/4	FORD	122425	17	19 1/4	1 1/4	VALIANT
122349	20 3/4	26 3/8	2	FORD	122427	17 3/8	23 1/8	1 1/4	FORD
122350	22 7/16	17 5/8	2	FORD	122428	17 3/8	23 1/8	2	FORD
122351	17 3/8	17 1/16	1 1/4	FORD	122429	17 3/8	20 3/8	1 1/4	FORD
122352	18	18 11/16	1 1/4	DODGE	122430	25	17 5/8	2	FORD
122353	13 1/2	19 13/16	1 1/4	JEEP	122431	20 13/16	14 7/8	1	TRIUMPH
122354	12 1/4	25 5/16	1 1/4	BUICK	122432	29	23 5/8	2	GMC
122355	27 1/2	17 3/4	1 9/16	JAGUAR	122435	18 3/8	22	1 1/4	CHRYSLER
122356	17 3/8	25 5/16	2	GMC	122436	17 7/8	24 3/16	2	FORD
122357	16 3/4	19 1/4	2	CHRYSLER	122437	18 3/8	19 1/4	1 1/4	CHRYSLER
122358	15 1/2	23 1/8	1 1/4	GMC	122438	20 3/4	15 3/8	2 5/8	GMC
122359	18	23 5/8	1 1/4	FORD	122439	17 1/8	22	1 1/4	VALIANT
122360	17	25 5/16	2	CHEVROLET	122440	15 1/2	20 7/8	1 1/4	ISUZU
122361	16 3/8	17 1/16	1 1/4	MUSTANG	122441	26 3/8	17 1/16	1 1/4	GMC
122362	12 1/4	25 5/16	2	GMC	122442	17 3/8	20 3/8	1 1/4	FORD
122363	15 1/2	18 11/16	1 1/4	BUICK	122443	26 3/8	17 1/16	2	PONTIAC
122366	23 5/16	17 5/8	2	FORD	122444	14 5/16	25 5/16	1 1/4	GMC
122369	24 3/4	23 1/8	2	CHEVROLET	122445	26 3/8	17 1/16	2 5/8	PONTIAC
122370	18	26 3/8	1 1/4	FORD	122446	14 5/16	25 5/16	2	GMC
122372	18	26 3/8	2	FORD	122447	14 5/8	24 3/16	1 1/4	RAMBLER
122374	17 3/8	17 1/16	1 1/4	FORD	122448	14 5/16	25 5/16	2 5/8	GMC
122378	17 3/8	25 5/16	2 5/8	GMC	122450	17 3/8	25 5/16	1 1/4	CADILLAC
122379	18 1/8	22	2	CHRYSLER	122451	24 3/4	23 1/8	1 1/4	CHEVROLET
122380	17	23 1/8	1 1/4	CHEVROLET	122452	22 3/8	19 1/4	2	STUDEBAKER
122381	16 1/8	16 1/2	2	INTERNATIONAL	122453	21 1/8	18 11/16	1 1/4	CHRYSLER
122382	14 1/8	18 11/16	1 1/4	CHEVROLET	122454	17 3/8	23 1/8	1 1/4	FORD
122387	18 1/8	22	2	CHRYSLER	122456	18	20 3/8	2	MERCEDES-BENZ
122388	18 5/8	25 5/16	2 5/8	GMC	122457	24 5/16	26 3/8	2	FORD TRUCK
122389	15 1/2	25 5/16	2 5/8	OLDSMOBILE	122460	18	15 3/8	1 1/4	DODGE
122390	17 3/8	25 5/16	2 5/8	OLDSMOBILE	122461	28 1/4	17 1/16	1 1/4	OLDSMOBILE
122392	17 3/8	17 1/16	1 1/4	FORD	122462	17 3/8	18 11/16	1 1/4	CHEVROLET
122393	17 3/8	23 1/8	2	FORD	122465	17 1/8	22	2	CHRYSLER
122395	17 3/4	24 3/16	2	STUDEBAKER	122468	16 3/8	17 1/16	2	FORD
122396	20 1/4	22	1 1/4	DODGE	122470	18 1/8	22	1 1/4	CHRYSLER
122398	18 1/8	22	2 5/8	CHRYSLER	122471	15 1/2	23 1/8	2	VOLVO
122399	18 1/8	22	2	CHRYSLER	122472	15 1/2	25 5/16	2	BUICK
122401	17 3/8	18 11/16	2	CHEVROLET	122473	17 5/8	17 1/16	1 1/4	INTERNATIONAL
122403	18	23 5/8	2	FORD	122475	17 3/8	20 3/8	1 1/4	FORD
122404	24	17 5/8	2	FORD	122476	24 3/4	23 1/8	2	CHEVROLET
122405	17 3/8	25 5/16	2	GMC	122477	17 3/8	20 3/8	1 1/4	FORD
122406	25 3/4	17 5/8	2	LINCOLN	122478	17 3/4	24 3/16	1 1/4	STUDEBAKER
122407	18	22	1 1/4	DODGE	122479	20 3/4	17 1/16	2	GMC
122409	28 1/4	17 1/16	2	OLDSMOBILE	122480	15 1/2	25 5/16	1 1/4	OLDSMOBILE
122411	20 3/4	17 1/16	1 1/4	CHEVROLET	122481	16 7/8	24 3/16	2	RAMBLER
122412	18	25 7/8	1 1/4	CHRYSLER	122483	20 3/4	17 1/16	2 5/8	BUICK
122413	20 3/4	17 1/16	2	BUICK	122485	16 7/8	24 3/16	1 1/4	RAMBLER
122414	24 5/8	23 5/8	2 5/8	GMC	122486	17	23 1/8	2	GMC
122416	29	23 5/8	2	GMC	122487	16 7/8	24 3/16	1 1/4	AMC
122417	12 5/8	18 11/16	2	GMC	122490	15 1/2	18 11/16	2	GMC
122418	29	23 5/8	2 5/8	GMC	122491	17 1/2	25 7/8	2	CHRYSLER
122420	20 5/16	22 9/16	2 5/8	FORD	122493	17 1/2	25 7/8	2 5/8	CHRYSLER

Vista-Pro Radiator Core Catalog

(Sort by Model)

Model #	Height	Width	Depth	Application	Model #	Height	Width	Depth	Application
122495	18	25 7/8	2	CHRYSLER	122576	22	17 1/16	2	GMC
122500	17	18 11/16	1 1/4	VALIANT	122577	15 3/4	24 3/16	1 1/4	RAMBLER
122501	16 3/8	17 1/16	1 1/4	FORD	122578	16	24 3/16	2	MUSTANG
122502	16 1/8	17 5/8	2	FORD	122579	24 1/2	18 1/8	2	LINCOLN
122503	20	17 5/8	2	FORD	122581	17 1/2	22	2	CHRYSLER
122504	14 5/8	24 3/16	1 1/4	AMC	122584	22	17 1/16	2 5/8	GMC
122505	28 1/4	17 1/16	2	GMC	122585	28 1/4	24 3/16	2 5/8	GMC
122506	20 1/4	22	1 1/4	DODGE	122586	17 1/2	17 1/16	2	INTERNATIONAL
122507	24 1/4	25 5/16	2	FORD	122587	17 3/8	24 3/16	1 1/4	FORD
122508	18 1/2	18 11/16	1 1/4	FORD	122588	19 1/2	26 3/8	1 1/4	FORD TRUCK
122509	18 1/2	18 11/16	2	FORD	122589	18 5/8	22	2	CHRYSLER
122512	25	19 1/4	2	LINCOLN	122590	17 3/8	20 3/8	1 1/4	FORD
122513	24 3/4	23 1/8	1 1/4	GMC	122591	17 3/8	23 1/8	1 1/4	FORD
122515	22 1/2	17 1/16	2 5/8	CHEVROLET	122593	17 3/8	23 1/8	2	FORD
122516	28 1/4	17 1/16	1 1/4	BUICK	122594	17 3/8	23 1/8	2	GMC
122517	16	25 5/16	2	GMC	122595	16 1/2	17 5/8	2	JEEP
122518	17 3/8	23 1/8	2	FORD	122596	18 1/8	27 1/2	1 1/4	CHRYSLER
122520	26 3/8	17 1/16	1 1/4	BUICK	122597	17 3/8	20 3/8	2	FORD
122521	26 3/8	17 1/16	2	GMC	122598	17 3/8	24 3/16	2	FORD
122522	17 1/2	25 7/8	1 1/4	PLYMOUTH	122599	26	17 1/16	2 5/8	CHEVROLET
122523	28 1/4	24 1/4	2	GMC	122601	15 1/2	23 1/8	2	CHEVROLET
122524	23 1/4	26 3/8	2	FORD	122603	28 1/4	17 1/16	2 5/8	GMC
122527	26 3/8	24 3/16	1 1/4	GMC	122604	20 3/4	17 1/16	2 5/8	GMC
122530	23	17 1/16	2	FIREBIRD	122605	17 3/8	20 3/8	2	FORD
122531	14 5/8	24 3/16	1 1/4	RAMBLER	122606	15 1/2	23 1/8	2	GMC
122532	16 7/8	24 3/16	1 1/4	RAMBLER	122607	23	17 1/16	2 5/8	GMC
122533	16 3/8	20 3/8	1 1/4	MUSTANG	122608	16 3/8	20 3/8	2	FORD
122534	16 3/8	17 1/16	2	FORD	122609	24 1/2	18 1/8	2 5/8	FORD
122535	15 7/8	23 1/8	2	FORD	122610	26	18 1/8	2 5/8	FORD
122536	17 3/8	23 1/8	1 1/4	FORD	122611	21 3/4	18 1/8	2 5/8	FORD
122541	25	19 1/4	1 1/4	FORD	122612	34	17 1/16	2 5/8	GMC
122544	14 1/4	18 11/16	1 1/4	JEEP	122613	20 3/4	11 9/16	2 5/8	GMC
122546	16 1/2	24 3/16	2	WILLYS	122615	18	25 7/8	2	CHRYSLER
122547	16 7/8	24 3/16	2	RAMBLER	122616	28	18 1/8	2 5/8	FORD
122548	28 1/4	17 1/16	2 5/8	GMC	122618	18 5/8	27 1/2	2	CHRYSLER
122550	26 3/8	24 3/16	2	GMC	122621	19 3/4	27 1/2	2	CHRYSLER
122551	18 1/2	18 11/16	1 1/4	FORD TRUCK	122623	34	17 1/16	2 5/8	GMC
122552	18 1/8	27 1/2	2 5/8	CHRYSLER	122624	32 1/2	17 1/16	2 5/8	GMC
122553	17 1/2	18 11/16	1 1/4	VALIANT	122625	27 1/2	17 1/16	2 5/8	GMC
122554	17 1/2	19 1/4	1 1/4	CHRYSLER	122626	18 5/8	27 1/2	2	CHRYSLER
122555	23	17 1/16	2	GMC	122627	24 1/2	18 1/8	2 5/8	FORD
122556	17 3/8	23 1/8	2	CHEVROLET	122630	18	25 7/8	2	CHRYSLER
122557	17 3/8	19 1/4	2	CHEVROLET	122633	26 3/8	17 1/16	2	GMC
122558	23	17 1/16	2 5/8	PONTIAC	122634	28	18 1/8	2 5/8	FORD
122559	23	17 1/16	1 1/4	APOLLO	122635	21 7/8	25 5/16	2	DODGE
122560	18 1/8	27 1/2	2	IMPERIAL	122646	16 1/2	17 1/16	2	INTERNATIONAL
122561	16 3/8	20 3/8	1 1/4	MUSTANG	122648	22	22	2	DODGE
122562	16	24 3/16	1 1/4	MUSTANG	122649	17 5/8	17 1/16	1 1/4	INT'L HARVESTER
122563	17 1/2	22	1 1/4	CHRYSLER	122650	28 7/8	27 1/2	2	INTERNATIONAL
122564	17 1/2	25 7/8	1 1/4	CHRYSLER	122651	22 1/4	25 5/16	1 1/4	DODGE
122569	17 3/8	23 1/8	1 1/4	CHEVROLET	122655	26 3/8	19 1/4	2 5/8	CHEVROLET
122570	25	19 1/4	2 5/8	FORD	122657	28 1/2	25 7/8	2	INTERNATIONAL
122573	18 3/8	22	2	CHRYSLER	122660	23 1/4	28 1/16	2 5/8	FORD TRUCK
122574	17 1/2	22	2	CHRYSLER	122663	23 1/8	22 9/16	2	INGERSOLL-RAND
122575	28 1/4	17 1/16	1 1/4	GMC	122664	23 1/8	22 9/16	1 1/4	INGERSOLL-RAND

Vista-Pro Radiator Core Catalog

(Sort by Model)

Model #	Height	Width	Depth	Application	Model #	Height	Width	Depth	Application
122666	14 3/8	19 1/4	2 5/8	LIFT TRUCKS & LOADERS	124527	12 3/4	14 7/8	2	OPEL
122668	14 1/4	19 13/16	2	LIFT TRUCKS & LOADERS	124528	11 3/4	11	2	OPEL
122669	13 7/8	15 3/8	2	LIFT TRUCKS & LOADERS	124531	14 5/8	24 3/16	1 1/4	AMC
122670	29 3/4	25 7/8	2	INTERNATIONAL	124532	14 5/8	24 3/16	1 1/4	AMC
122671	21 1/2	19 13/16	2	ONAN	124533	15 7/8	23 1/8	1 1/4	FORD
122672	31	26 3/8	2	INTERNATIONAL	124534	21 3/4	18 1/8	1 1/4	FORD
122673	32	25 5/16	2 5/8	GMC	124535	21 3/4	18 1/8	2	FORD
122674	24 1/4	26 3/8	2 5/8	INTERNATIONAL	124538	17 1/2	25 7/8	2	CHRYSLER
122675	25 1/4	25 7/8	2	FORD TRUCK	124539	17 7/8	22	1 1/4	DODGE
122679	24 1/2	17 5/8	1 1/4	FORD	124540	15 1/2	20 3/8	2	FORD
122680	15 1/4	21 1/2	2 1/4	JAGUAR	124541	19 1/4	25 7/8	2	FORD
122681	16	27 1/4	1 9/16	MERCEDES-BENZ	124542	18 3/8	22	1 1/4	CHRYSLER
122682	16 5/8	25 7/8	2	MERCEDES-BENZ	124544	16 7/8	22	1 1/4	CHRYSLER
122685	20 1/16	12 3/8	1 9/16	PORSCHE	124546	16 7/8	22	2	CHRYSLER
122689	23 1/2	12 13/16	1 9/16	SAAB	124547	17 7/8	18 11/16	1 1/4	DODGE
122691	16 1/8	21 1/2	1 9/16	MAZDA	124549	24 5/8	22	2	INTERNATIONAL
122694	24 5/8	22	2	INTERNATIONAL	124551	14 5/8	24 3/16	1 1/4	FORD
122695	15 1/4	19 13/16	2	MERCEDES-BENZ	124555	34	17 1/16	2	OLDSMOBILE
122699	20 5/8	12 13/16	1 9/16	SAAB	124556	34	24 3/16	2	GMC
122700	31	25 7/8	2	NAVISTAR	124557	34	24 3/16	2 5/8	GMC
122701	13 3/8	15 11/16	1 9/16	BMW	124560	12 1/4	23 1/8	2	BUICK
122702	13 3/8	15 11/16	1 9/16	BMW	124562	12	11 9/16	1 1/4	VEGA
122703	19 1/4	25 7/8	2	FORD TRUCK	124563	20 3/4	11 9/16	1 1/4	VEGA
122704	18	18 1/8	1 1/4	FORD	124565	28 1/4	17 1/16	2	GMC
122705	22	22	2	DODGE	124567	15 1/4	17 1/16	1 1/4	PINTO
122711	31	25 7/8	2	NAVISTAR	124570	27 1/2	17 1/16	2	FIREBIRD
122712	19 5/8	17 1/16	2 5/8	LIFT TRUCKS & LOADERS	124571	15 1/8	18 11/16	1 1/4	RAMBLER
122714	17 3/8	15 3/8	2 5/8	JOHN DEERE	124573	16 7/8	23 5/8	1 1/4	AMC
124032	27 1/2	26 3/8	2 5/8	FORD TRUCK	124575	15 3/4	24 3/16	2	AMC
124033	31	12 1/8	2	NAVISTAR	124582	17 1/2	22	1 1/4	CHRYSLER
124034	28 1/4	17 1/16	2 5/8	GMC	124586	15 1/4	17 5/8	1 1/4	FORD
124037	21 5/8	23 5/8	2	NISSAN	124588	14 1/2	21 7/16	2	TRIUMPH
124041	31	12 1/8	2 5/8	NAVISTAR	124590	20 1/4	22	2	DODGE
124051	31	25 7/8	2	INTERNATIONAL	124591	18	25 7/8	1 1/4	DODGE
124061	31	25 7/8	2	NAVISTAR	124593	19 1/4	19 1/4	2	FORD
124091	27 1/2	26 3/8	2	FORD TRUCK	124596	28 1/4	24 3/16	1 1/4	GMC
124182	17 1/4	17 5/8	2 5/8	JAGUAR	124597	22 3/16	19 1/4	2	INTERNATIONAL
124404	26 1/2	25 7/8	2	INTERNATIONAL	124598	17 5/8	17 1/16	1 1/4	INTERNATIONAL
124501	26 3/8	17 1/16	1 1/4	GMC	124599	17 1/2	28 1/16	1 1/4	INTERNATIONAL
124502	26	18 1/8	1 1/4	FORD	124600	17 1/2	28 1/16	1 1/4	INTERNATIONAL
124504	27 1/2	17 1/16	2 5/8	GMC	124601	17 5/8	24 3/16	1 1/4	INTERNATIONAL
124505	17	22	2	CHRYSLER	124603	22 3/4	18 11/16	1 1/4	BMW
124506	18	18 11/16	1 1/4	CHRYSLER	124604	13 3/4	23 5/8	1 1/4	DATSUN
124507	17 3/8	18 11/16	1 1/4	PLYMOUTH	124606	14 3/4	17 5/8	1 1/4	TOYOTA
124510	21 3/4	25 5/16	1 1/4	CHRYSLER	124607	15 3/4	22	2 5/8	TOYOTA
124511	26	18 1/8	2	FORD	124608	12	11 9/16	2	GMC
124513	21 3/4	25 5/16	2	DODGE	124611	10 3/4	19 1/4	1 1/4	NISSAN
124514	16 3/8	20 3/8	1 1/4	FORD	124612	10 3/4	19 1/4	1 1/4	DATSUN
124515	16 3/8	23 5/8	2	FORD	124613	13	13 3/4	1 1/4	DATSUN
124516	18 3/8	25 7/8	2	DODGE	124614	14 1/4	15 3/8	2	NISSAN
124517	16 7/8	22	1 1/4	WILLYS	124615	25 3/4	18 1/8	2	JAGUAR
124519	15 7/8	25 7/8	2	WILLYS	124619	20 5/8	13 3/16	2	SAAB
124520	15 3/4	24 3/16	2	RAMBLER	124623	10 3/4	20 7/8	2	SUNBEAM
124521	19 1/2	18 11/16	1 1/4	DODGE	124625	12 3/4	19 1/4	1 1/4	TOYOTA
124522	15 1/4	17 5/8	1 1/4	TOYOTA	124629	15 1/4	27 1/2	2 5/8	JAGUAR

Vista-Pro Radiator Core Catalog

(Sort by Model)

Model #	Height	Width	Depth	Application	Model #	Height	Width	Depth	Application
124636	18	25 7/8	1 1/4	DODGE	124719	19 1/4	25 7/8	2	FORD
124637	17 1/4	22	1 1/4	VALIANT	124720	15 1/4	17 1/16	1 1/4	FORD
124638	18 3/8	18 11/16	1 1/4	DODGE	124722	29 3/4	23 5/8	2	GMC
124640	17 7/8	22	2	CHRYSLER	124723	29 3/4	23 5/8	2 5/8	GMC
124642	28	18 1/8	1 1/4	FORD	124724	20 1/4	14 5/16	2 5/8	JOHN DEERE
124643	28	18 1/8	2	FORD	124725	12 3/4	19 1/4	1 1/4	TOYOTA
124644	17 3/8	17 5/8	2	FORD	124726	34	17 1/16	2	TORONADO
124645	22 1/2	19 1/4	2	FORD	124727	32 1/2	17 1/16	2	CADILLAC
124646	16 3/8	20 3/8	1 1/4	MAVERICK	124728	14 1/4	21 7/16	1 1/4	DATSUN
124655	22	19 1/4	1 1/4	INTERNATIONAL	124729	14 3/4	19 1/4	2	TOYOTA
124656	17 5/8	24 3/16	2	INTERNATIONAL	124730	13	13 3/4	1 1/4	DATSUN
124657	21 5/8	22	1 1/4	INTERNATIONAL	124731	20 3/8	14 7/8	1 1/4	CHEVROLET
124658	18 1/4	25 7/8	2	FORD	124732	20 3/8	14 7/8	2	BUICK
124659	17 1/4	13 3/4	2 5/8	JOHN DEERE	124733	27 1/2	17 1/16	1 1/4	FIREBIRD
124660	21	19 1/4	1 1/4	DODGE	124734	27 1/2	17 1/16	2	FIREBIRD
124661	24 7/8	22	2	INTERNATIONAL	124735	18 5/8	27 1/2	1 1/4	CHRYSLER
124662	18	22	2	CHRYSLER	124737	19	18 11/16	1 1/4	PLYMOUTH
124663	18 3/8	22	2	CHRYSLER	124741	24 1/2	18 1/8	1 1/4	FORD
124664	24 5/8	22	1 1/4	INTERNATIONAL	124742	24 1/2	18 1/8	2	MERCURY
124667	21 3/8	19 13/16	2	WORTHINGTON	124743	16 3/8	17 1/16	1 1/4	FORD
124669	23	23 5/8	1 1/4	WORTHINGTON	124745	17 3/8	23 1/8	2	FORD
124672	28 1/4	19 1/4	2 5/8	GMC	124746	15 1/2	19 13/16	2	FORD
124673	29 1/2	18 1/8	1 1/4	FORD	124747	16	25 7/8	2	WILLYS
124674	29 1/2	18 1/8	2	FORD	124748	16	25 7/8	1 1/4	WILLYS
124675	18 1/2	25 7/8	2	CHRYSLER	124749	13	18 11/16	1 1/4	DATSUN
124676	18 1/2	25 7/8	2	CHRYSLER	124751	25 3/4	9 7/8	1 1/4	FIAT
124677	18 5/8	27 1/2	1 1/4	CHRYSLER	124752	10 5/8	22	2	MAZDA
124678	18 5/8	27 1/2	2	DODGE	124754	12 5/8	23 5/8	2	MAZDA
124679	13 1/2	17 1/16	1 1/4	CHEVROLET	124759	23	15 15/16	1 1/4	PACER
124680	13	17 5/8	1 1/4	NISSAN	124761	16 1/4	13 3/16	2	AUDI
124682	17 7/8	25 7/8	2	CHRYSLER	124763	17 3/8	20 3/8	1 1/4	FORD
124683	15 5/8	24 3/16	1 1/4	WILLYS	124764	21 5/8	22	2	INTERNATIONAL
124684	17 5/8	16 1/2	1 1/4	VOLVO	124765	18	22	1 1/4	CHRYSLER
124685	18 1/2	25 7/8	1 1/4	CHRYSLER	124766	24 1/4	26 3/8	2	FORD
124689	16 3/8	20 3/8	2	FORD	124767	24 1/4	26 3/8	2 5/8	FORD
124690	16 3/8	20 3/8	2	FORD	124768	20 1/4	13 3/4	2 5/8	JOHN DEERE
124693	18 3/8	22	1 1/4	DODGE	124769	21 3/4	13 3/4	2 5/8	JOHN DEERE
124695	16 3/8	20 3/8	2	FORD	124771	16 7/8	22	2	VALIANT
124697	16 7/8	24 3/16	1 1/4	MATADOR	124772	18 1/2	25 7/8	2	CHRYSLER
124698	16 7/8	24 3/16	2	GREMLIN	124773	14 3/4	20 7/8	1 1/4	TOYOTA
124699	15 3/4	17 1/16	1 1/4	WILLYS	124774	14 3/4	20 7/8	2	TOYOTA
124700	16 3/8	24 3/16	2	WILLYS	124775	15 3/4	20 7/8	2	TOYOTA
124701	16 3/8	24 3/16	1 1/4	WILLYS	124776	16	24 3/16	2	MERCEDES-BENZ
124702	15 5/8	24 3/16	2	WILLYS	124778	20 7/8	25 7/8	2	CHRYSLER
124706	13 3/4	23 5/8	2	DATSUN	124779	16	24 3/16	2	DATSUN
124707	11 7/8	15 3/8	1 1/4	HONDA	124781	21 1/8	30 1/4	2	FORD
124708	16 3/4	12 5/8	2	MAZDA	124782	24	15 15/16	1 1/4	RAMBLER
124709	34	17 1/16	2	OLDSMOBILE	124783	24	15 15/16	2	PACER
124710	16 1/2	23 5/8	1 1/4	MERCEDES-BENZ	124784	16 7/8	24 3/16	1 1/4	RAMBLER
124713	15 3/4	19 1/4	1 1/4	TOYOTA	124785	12	14 7/8	1 1/4	CHEVROLET
124714	15 3/4	19 1/4	2	TOYOTA	124786	12	14 7/8	2	GMC
124715	17 5/8	16 1/2	2	VOLVO	124787	16 7/8	14 7/8	1 1/4	CHEVROLET
124716	28 1/4	19 1/4	2	GMC	124788	16 7/8	14 7/8	2	CHEVROLET
124717	22	25 7/8	2	DODGE	124790	16 3/4	11 9/16	1 1/4	GMC
124718	18	23 5/8	1 1/4	FORD	124792	11 3/8	21 7/16	2	MAZDA

Vista-Pro Radiator Core Catalog

(Sort by Model)

Model #	Height	Width	Depth	Application	Model #	Height	Width	Depth	Application
124794	13	18 11/16	2	DATSUN	124890	19	19 13/16	1 1/4	LINCOLN ELECTRIC
124797	13 3/8	15 15/16	1 1/4	BMW	124897	26 3/8	17 1/16	1 1/4	BUICK
124798	19 3/4	27 1/2	2	IMPERIAL	124902	18 1/8	22	1 1/4	CHRYSLER
124799	11 1/2	18 11/16	1 1/4	FIAT	124905	16 1/2	23 1/8	2	MUSTANG
124801	12 1/2	19 13/16	2	VOLVO	124906	19 5/8	8 13/16	1 1/4	FORD
124802	16 1/2	20 7/8	2	MERCEDES-BENZ	124908	13 1/4	17 5/8	1 1/4	BMW
124803	16 7/8	22	2	MERCEDES-BENZ	124909	22 3/4	18 11/16	2	BMW
124804	16 3/8	17 1/16	2	FORD	124912	14 1/8	24 3/16	2	DATSUN
124805	16 3/8	16 1/2	2	TRIUMPH	124913	13 1/2	19 13/16	1 1/4	OPEL
124806	16 3/8	17 1/16	2	JEEP	124915	14	18 1/8	2	MG
124807	10 5/16	18 1/8	2	MG	124916	18	25 7/8	2	MERCEDES-BENZ
124808	18	23 5/8	2	FORD	124920	9 5/8	15 3/8	2	TRIUMPH
124809	17	19 1/4	2	TOYOTA	124922	28 1/4	19 1/4	2	GMC
124810	14 1/4	10 7/16	1 1/4	MG	124923	23 3/4	25 7/8	2	DODGE
124811	13 1/4	15 3/8	1 1/4	BMW	124925	18	23 5/8	1 1/4	FORD
124814	18	23 5/8	2	FORD	124926	20 3/8	25 7/8	1 1/4	FORD
124815	19 1/4	25 7/8	2 5/8	FORD	124927	20 3/8	25 7/8	2	FORD
124820	17 3/4	27 1/2	2	CHRYSLER	124928	26 1/2	25 7/8	2	INTERNATIONAL
124821	19 3/4	27 1/2	2	CHRYSLER	124929	26 5/8	25 5/16	2	INTERNATIONAL
124823	18	25 7/8	1 1/4	PLYMOUTH	124930	28 1/2	25 7/8	2	INTERNATIONAL
124825	17 3/4	22	2	CHRYSLER	124931	34	17 1/16	2 5/8	GMC
124827	13	21 7/16	2	DATSUN	124932	16 7/8	18 1/8	2	MILLER WELDER
124828	30 1/2	17 1/16	1 1/4	BUICK	124933	15 1/4	20 3/8	1 1/4	MUSTANG
124829	30 1/2	17 1/16	2	CADILLAC	124934	10 3/4	19 1/4	2	NISSAN
124830	20 3/8	14 7/8	1 1/4	BUICK	124938	15 3/4	18 1/8	2	FORD TRUCK
124831	31	25 7/8	2 5/8	NAVISTAR	124939	19 3/4	27 1/2	1 1/4	CHRYSLER
124832	16 3/8	20 3/8	1 1/4	PINTO	124941	13 3/4	23 5/8	2	DATSUN
124833	16 3/8	17 1/16	1 1/4	MERCURY	124944	28	18 1/8	2	FORD
124834	13 3/4	19 1/4	1 1/4	HONDA	124945	18	18 11/16	1 1/4	CHRYSLER
124835	16	26 3/8	2	JEEP	124946	12 3/4	16 1/2	1 1/4	PLYMOUTH
124836	15 1/2	24 3/16	1 1/4	WILLYS	124950	14 3/8	24 3/16	1 1/4	NISSAN
124837	15 1/2	24 3/16	2	WILLYS	124951	10 3/4	19 1/4	2	NISSAN
124840	22 3/4	18 11/16	1 1/4	BMW	124952	19 1/4	25 7/8	1 1/4	FORD
124843	13	18 1/8	1 1/4	NISSAN	124953	20 3/4	17 1/16	1 1/4	CHEVROLET
124846	11	9 7/8	2	HONDA	124954	17 3/4	19 1/4	2	LIFT TRUCKS & LOADERS
124847	11 7/8	15 3/8	2	HONDA	124955	15 3/4	17 1/16	2 5/8	LIFT TRUCKS & LOADERS
124849	12 7/8	20 7/8	1 1/4	HONDA	124956	37 1/4	24 3/16	2	GMC
124852	27 3/8	18 1/8	2 5/8	JAGUAR	124957	37 1/4	24 3/16	2 5/8	GMC
124856	16 5/8	10 7/16	1 1/4	MG	124958	21 3/8	19 13/16	1 1/4	LINCOLN ELECTRIC
124858	16	26 15/16	1 1/4	MERCEDES-BENZ	124967	14 3/4	19 1/4	1 1/4	HONDA
124859	16	26 15/16	2	MERCEDES-BENZ	124968	13 7/8	20 1/4	1 9/16	FIAT
124860	18	25 7/8	1 1/4	MERCEDES-BENZ	124970	31	25 7/8	2	INTERNATIONAL
124863	13 7/8	17 5/8	2	OPEL	124973	20 1/2	12 5/8	1 1/4	HONDA
124874	17 1/8	19 1/8	2 5/8	LIFT TRUCKS & LOADERS	124974	20	26 15/16	2	CHRYSLER
124874	17 1/8	19 1/8	2 5/8	LIFT TRUCKS & LOADERS	124975	15 1/8	17 1/16	1 1/4	JEEP
124875	21 1/2	15 3/8	2	TRIUMPH	124977	18	26	1	CHRYSLER
124877	12 1/2	19 1/4	2	VOLVO	124979	16 7/8	14 7/8	1 1/4	CHEVROLET
124879	26 3/8	19 1/4	2 5/8	GMC	124980	15 3/4	25 5/16	1 1/4	TOYOTA
124880	22	25 7/8	1 1/4	CHRYSLER	124982	19 3/4	14 7/8	1 1/4	OMNI-HORIZON
124883	17 1/4	18 1/8	2	JOHN DEERE	124983	24 1/2	18 1/8	1 1/4	FORD
124885	30 1/4	26 3/8	1 1/4	FORD TRUCK	124984	29 3/4	25 7/8	2 5/8	INTERNATIONAL
124886	30 1/4	26 3/8	2	FORD TRUCK	124985	27 9/16	19 13/16	2	FORD TRUCK
124887	30 1/4	26 3/8	2 5/8	FORD TRUCK	124986	29 3/4	25 7/8	2	INTERNATIONAL
124888	17 1/2	28 1/16	2	INTERNATIONAL	124987	16 7/8	14 7/8	1 1/4	GMC
124889	27 1/8	25 7/8	2	NAVISTAR	124988	21 5/8	19 13/16	1 1/4	FORD TRUCK

Vista-Pro Radiator Core Catalog

(Sort by Model)

Model #	Height	Width	Depth	Application	Model #	Height	Width	Depth	Application
124989	23 5/8	14 7/8	1 1/4	INTERNATIONAL	128195	19 5/8	14 7/8	2	GMC
124991	27 9/16	19 13/16	1 1/4	FORD TRUCK	128196	23 5/8	14 7/8	2	GMC
124993	23	13 3/16	1 1/4	SUBARU	128197	16 7/8	17 1/16	2	GMC
124994	27 1/8	17 5/8	1 1/4	JAGUAR	128198	26 3/8	17 1/16	2	GMC
124996	18 5/8	27 1/2	1 1/4	DODGE	128199	28 1/4	17 1/16	2	GMC
124998	20 1/2	15 3/8	1 1/4	OMNI-HORIZON	128200	29 3/4	25 5/8	2 1/4	NAVISTAR
128003	29 3/4	25 13/16	2	INTERNATIONAL	128202	18 1/8	20 3/8	1 1/4	MERCEDES-BENZ
128101	14 3/4	20 5/8	1 9/16	TOYOTA	128203	13 7/8	18 11/16	1 1/4	FIAT
128103	26 1/2	26 3/8	1 1/4	INTERNATIONAL	128204	15 1/4	21 7/16	1 1/4	ISUZU
128104	20 5/8	13 3/16	1 1/4	SAAB	128205	20 3/8	12 5/8	1 1/4	SAAB
128105	16 7/8	15 1/4	1	CHEVROLET	128207	17 3/8	25 5/16	2	GMC
128106	23 5/8	15 1/4	1	CHEVROLET	128211	26 3/8	16 15/16	1 9/16	GMC
128107	23 5/8	15 1/4	1 9/16	GMC	128215	16 1/8	21 1/16	1	MAZDA
128108	21 5/8	19 13/16	2	FORD	128217	23 1/4	27 1/2	1 1/4	FORD
128109	16 5/8	19 13/16	1 1/4	MILLER WELDER	128218	28 1/4	16 15/16	1 9/16	GMC
128110	16	16 1/2	1 1/4	GMC	128221	13 1/4	15 1/4	1	BMW
128111	16 5/8	10 7/16	2	MG	128222	16 1/2	23 9/16	1 9/16	MERCEDES-BENZ
128115	19 1/4	15 15/16	1 1/4	PEUGEOT	128228	11 7/8	15 1/4	1 9/16	HONDA
128118	12 5/8	18 1/8	2	ALFA ROMEO	128248	17 3/4	22	2	MERCEDES-BENZ
128119	15 3/4	12 5/8	1 1/4	HONDA	128250	11 3/4	17 3/4	1	MAZDA
128121	25 5/8	18 1/8	2 5/8	JAGUAR	128261	23 5/8	31 3/8	2	FORD
128123	16 3/4	25 7/8	1 1/4	MERCEDES-BENZ	128272	17 7/8	15 3/8	1 1/4	CHRYSLER
128125	14 3/4	25 5/16	1 1/4	TOYOTA	128274	24 5/16	26 3/8	2 5/8	FORD
128126	15 1/4	12 5/8	1 1/4	TRIUMPH	128275	12 1/2	19 13/16	2	VOLVO
128127	23 1/4	27 1/2	2	FORD	128276	15 3/4	21 1/16	1	TOYOTA
128128	23 1/4	27 1/2	1 1/4	FORD TRUCK	128278	13 5/8	20 7/8	1 1/4	GMC
128131	21 1/8	30 1/4	2 5/8	FORD	128280	34	19	2 1/4	GMC
128132	27 1/2	26 3/8	2 5/8	FORD TRUCK	128282	21	25 7/8	2	DODGE
128133	16 7/8	15 1/4	1 9/16	GMC	128283	26 3/8	13 3/16	1 1/4	DATSUN
128137	29	27 1/2	1 1/4	FORD TRUCK	128290	28 1/4	26 3/8	2 5/8	GMC
128138	29	27 1/2	2	FORD	128296	30 1/2	16 15/16	1 9/16	GMC
128141	13	16 1/2	1 1/4	DATSUN	128299	34	19	1 9/16	GMC
128142	20 3/8	26 3/8	1 1/4	FORD TRUCK	128302	20 11/16	19 13/16	1 1/4	GMC
128143	24 1/4	25 5/16	2 5/8	INTERNATIONAL	128303	18 7/8	19 13/16	1 1/4	GMC
128148	34	19 1/4	2 5/8	GMC	128304	22 1/8	22	2	GMC
128149	26 3/8	17 1/16	1 1/4	GMC	128305	17 3/4	23 1/8	1 1/4	GMC
128150	28 1/4	17 1/16	1 1/4	GMC	128306	22 1/8	22	1 1/4	GMC
128152	13 1/8	25 5/16	2	NISSAN	128307	16 3/4	21 7/16	1 1/4	GMC
128154	16 7/8	25 5/16	1 1/4	DATSUN	128308	16 3/4	23 1/8	1 1/4	GMC
128155	23 1/4	16 1/2	1 1/4	VOLVO	128309	18 1/2	20 3/8	2	CHRYSLER
128157	19 5/8	15 1/4	1	GMC	128310	21 1/8	23 1/8	1 1/4	GMC
128158	19 5/8	15 1/4	1 9/16	GMC	128311	20 1/2	23 1/8	1 1/4	GMC
128165	12 3/4	16 1/2	2	TOYOTA	128314	17 5/8	20 3/8	2	CHRYSLER
128171	23 1/4	16 1/2	2	VOLVO	128316	20	23 1/8	2	GMC
128175	34	16 15/16	2 1/4	GMC	128317	18 1/8	22	1 1/4	CHRYSLER
128177	16 3/4	23 1/8	2	MERCEDES-BENZ	128318	18 1/8	22	1 1/4	CHRYSLER
128178	17 3/4	22	2	MERCEDES-BENZ	128319	17 1/2	22	1 1/4	CHRYSLER
128179	16 5/8	25 7/8	2	MERCEDES-BENZ	128321	16 3/4	20 3/8	2 5/8	MERCEDES-BENZ
128182	26 3/8	16 15/16	1	GMC	128322	17 1/4	18 11/16	2	MERCEDES-BENZ
128183	26 3/8	16 15/16	1 9/16	GMC	128323	17 1/2	18 11/16	2 5/8	MERCEDES-BENZ
128184	28 1/4	16 15/16	1	GMC	128328	16 7/8	24 3/4	1 1/4	AMC
128185	28 1/4	16 15/16	1 9/16	GMC	128329	11 1/4	14 7/8	2	AUSTIN
128187	28 1/4	19	1 9/16	GMC	128330	13 5/8	22 9/16	2	MERCEDES-BENZ
128192	31	12 5/8	2 1/4	NAVISTAR	128331	17 7/8	23 5/8	1 1/4	FORD
128194	16 7/8	14 7/8	2	GMC	128332	17 7/8	23 1/8	2	FORD

Vista-Pro Radiator Core Catalog

(Sort by Model)

Model #	Height	Width	Depth	Application	Model #	Height	Width	Depth	Application
128333	17 3/8	25 5/16	2 5/8	GMC	128438	15 3/4	18 11/16	2	MERCEDES-BENZ
128334	15 1/4	17 1/16	2	FORD	128439	17 1/8	19 13/16	2 5/8	TOYOTA
128335	15 1/4	17 1/16	2	FORD	128440	14	17 5/8	2	FORD
128336	17	15 3/8	2	AUSTIN	128442	14 1/8	21 7/16	2	NISSAN
128339	11 3/8	14 7/8	2	MG	128444	11 1/2	19 1/4	1 1/4	AUSTIN
128340	15 3/4	18 11/16	1 1/4	MERCEDES-BENZ	128445	23 5/8	19 13/16	2 5/8	AUSTIN
128341	18 1/8	18 11/16	2	CHRYSLER	128446	18	25 7/8	2	MERCEDES-BENZ
128343	17 3/8	23 1/8	2	FORD	128447	18 3/8	18 11/16	2	CHRYSLER
128344	16 3/8	19 1/4	2	JEEP	128448	15 3/4	17 1/16	2	JEEP
128345	16 1/2	22	1 1/4	JEEP	128449	23 1/4	15 15/16	1 1/4	AMC
128346	16 5/8	22	2	JEEP	128453	13 1/2	19 13/16	1 1/4	NISSAN
128347	16 5/8	22	2	JEEP	128454	21 1/8	15 3/8	1 1/4	TRIUMPH
128348	16 5/8	22	2	JEEP	128457	16	24 3/16	2	JEEP
128349	10 5/8	10 7/16	2	AUSTIN	128459	26 3/8	17 1/16	2 5/8	GMC
128351	16 3/4	22	2 5/8	MERCEDES-BENZ	128460	20 3/8	14 7/8	2 5/8	GMC
128353	15 1/2	25 5/16	2 5/8	GMC	128461	19 7/8	22 9/16	1 1/4	CHRYSLER
128354	15 1/2	25 5/16	2 5/8	GMC	128462	24	23 5/8	2 5/8	FORD
128355	26 3/8	17 1/16	2 5/8	GMC	128464	18 7/8	21 7/16	1 1/4	GMC
128357	18 1/2	17 1/16	2 5/8	GMC	128465	21 3/4	25 5/16	2	DODGE
128358	16 1/8	19 13/16	2	JEEP	128466	17 7/8	26 3/8	2 5/8	FORD
128360	26	15 15/16	2 5/8	JAGUAR	128467	20 3/8	22	2	CHRYSLER
128361	17	17 1/16	2 5/8	JAGUAR	128468	24 3/4	23 1/8	2	GMC
128362	17 1/4	19 13/16	2 5/8	JAGUAR	128470	21	18 11/16	2	DODGE
128363	17 1/4	19 13/16	2 5/8	JAGUAR	128471	19 1/2	18 11/16	2	CHRYSLER
128364	11 5/8	13 3/4	2	MG	128472	21 1/4	22	1 1/4	CHRYSLER
128365	18 1/2	17 1/16	2 5/8	GMC	128473	24 1/4	26 3/8	2	FORD
128366	18 5/8	15 3/8	2	SUNBEAM	128474	21 1/2	23 5/8	2	FORD TRACTOR
128367	18 1/2	16 1/2	2	TRIUMPH	128475	13 1/2	17 1/16	2	GMC
128371	15 1/4	21 7/16	2	JAGUAR	128476	18 3/4	26 3/8	2	FORD
128373	15 1/4	20 3/8	2	MERCEDES-BENZ	128477	20 11/16	19 13/16	2 5/8	GMC
128376	12 3/4	12 5/8	2 5/8	TRIUMPH	128478	20	23 5/8	2 5/8	GMC
128378	17 13/16	18 11/16	2	CHRYSLER	128479	18 7/8	21 7/16	2	GMC
128380	16 3/8	20 1/4	1 9/16	FORD	128480	18 11/16	19 13/16	2	GMC
128383	14 1/16	19 13/16	2	MG	128481	26 1/4	25 7/8	2 5/8	INTERNATIONAL
128385	27 1/2	17 1/16	2	GMC	128482	20	21 7/16	2	GMC
128387	16 1/8	25 7/8	2 5/8	ROLLS ROYCE	128485	24 3/4	23 1/8	2 5/8	GMC
128392	18 3/8	22	2	CHRYSLER	128488	19 1/8	19 1/4	2 5/8	FORD
128395	17 11/16	17 5/8	2	VOLVO	128489	18 1/4	26 3/8	2 5/8	FORD
128398	15 1/8	18 11/16	1 1/4	CHRYSLER	128490	9 7/8	21 7/16	2	TRIUMPH
128399	17 7/8	22	2 5/8	CHRYSLER	128491	21 3/8	12 5/8	2	VOLKSWAGEN
128401	19 1/8	19 1/4	2 5/8	FORD	128495	8 3/4	8 13/16	2	HONDA
128402	16 7/8	22	2	WILLYS	128497	16 1/2	18 1/8	2	MERCEDES-BENZ
128403	17	25 5/16	2 5/8	GMC	128502	15 3/4	25 7/8	1 1/4	AMC
128404	15 1/2	23 5/8	2 5/8	GMC	128506	17 3/8	20 3/8	2 5/8	FORD
128405	15 3/4	25 7/8	2	JEEP	128507	31	25 7/8	2 5/8	NAVISTAR
128409	17	18 11/16	1 1/4	CHRYSLER	128508	17	21 7/16	2	JEEP
128411	18 1/2	25 7/8	1 1/4	CHRYSLER	128509	16 1/4	25 7/8	2 5/8	JEEP
128413	12 5/8	18 1/8	1 1/4	ALFA ROMEO	128511	16 1/8	24 3/16	2 5/8	NISSAN
128414	13	11 9/16	2	FIAT	128512	12 1/4	25 7/8	2 5/8	FERRARI
128415	15 5/16	13 3/4	2	AUDI	128513	15 1/2	21 7/16	2 5/8	JAGUAR
128422	17 3/4	18 11/16	2	MERCEDES-BENZ	128522	17	22	1 1/4	INTERNATIONAL
128430	18	18 11/16	2 5/8	CHRYSLER	128523	15 5/8	17 1/16	1 1/4	INTERNATIONAL
128431	15 1/8	18 11/16	2	AMC	128524	26 1/2	25 5/16	2 5/8	INTERNATIONAL
128432	13 1/4	15 3/8	2	BMW	128526	28 1/4	26 3/8	2 5/8	GMC
128433	16 7/8	24 3/16	1 1/4	AMC	128528	18	25 7/8	2	CHRYSLER

Vista-Pro Radiator Core Catalog

(Sort by Model)

Model #	Height	Width	Depth	Application	Model #	Height	Width	Depth	Application
128529	19 3/4	27 1/2	2	CHRYSLER	128638	28 1/4	17 1/16	2	GMC
128530	24 1/2	22	2 5/8	INTERNATIONAL	128639	28 1/4	17 1/16	2	GMC
128531	28 1/4	27 1/2	2 5/8	GMC	128640	28 1/4	17 1/16	2	GMC
128537	20 3/8	22	2	CHRYSLER	128641	17 7/8	25 7/8	1 1/4	CHRYSLER
128546	18	18 1/8	2	FORD	128642	18 1/2	25 7/8	1 1/4	CHRYSLER
128547	16 1/8	14 1/16	1	GMC	128643	16	25 5/16	1 1/4	GMC
128551	16 1/2	20 3/8	2	MERCEDES-BENZ	128644	16 3/8	16 1/2	2 5/8	TRIUMPH
128552	28 1/4	16 15/16	1 9/16	GMC	128645	15 5/8	22	2	TOYOTA
128553	28 1/4	16 15/16	2.25	MISC	128646	18	22	2	CHRYSLER
128558	20 1/2	22 9/16	2	PACKARD	128651	32 1/2	17 1/16	2	GMC
128563	14 3/4	22 9/16	1 1/4	MAZDA	128652	21 3/4	25 5/16	2	DODGE
128564	23 5/8	31 3/8	2	FORD	128653	24 1/4	26 3/8	2 5/8	FORD
128565	15 1/2	37 15/16	2 5/8	FORD	128654	24 5/16	26 3/8	2 5/8	FORD
128566	13 3/4	23 5/8	1 1/4	MITSUBISHI	128655	22	28 1/16	2	GMC
128577	30 1/2	16 15/16	1	GMC	128656	25	22	2	INTERNATIONAL
128579	28 1/4	19	2 1/4	GMC	128657	20 1/4	22	2 5/8	CHRYSLER
128585	34	16 15/16	2 1/4	GMC	128658	21 3/4	25 5/16	2 5/8	DODGE
128586	34	17 3/8	1 9/16	GMC	128659	24 5/16	26 3/8	2	FORD
128587	12 3/4	16 1/2	2	HYUNDAI	128660	18	23 5/8	2 5/8	FORD
128589	23 5/8	31 3/8	3 1/4	FORD	128663	28 1/4	19 1/4	2 5/8	GMC
128590	16 9/16	19 13/16	2	MILLER ELECTRIC	128664	18	25 7/8	2 5/8	CHRYSLER
128591	27 1/2	26 3/8	2	FORD TRUCK	128665	20 1/4	22	2	CHRYSLER
128596	15 3/16	17 5/8	1 1/4	JEEP	128666	15 9/16	17 1/16	2	CHEVROLET
128597	16 3/4	20 3/8	1 1/4	JEEP	128667	20 11/16	19 13/16	2	GMC
128600	20	23 5/8	1 1/4	FORD	128668	21	25 7/8	2 5/8	CHRYSLER
128601	18 7/8	22	2 5/8	CHRYSLER	128669	19 1/2	19 1/4	2	FORD
128602	19 13/16	19 1/4	1 1/4	CHEVROLET	128671	14 1/4	14 5/16	2	NISSAN
128604	18 1/8	25 5/16	2	FORD	128672	12 3/4	18 1/8	1 1/4	MAZDA
128606	15 1/4	17 1/16	1 1/4	FORD	128674	16	24 3/16	2 5/8	FORD
128607	23 1/4	17 5/8	2	FORD	128675	16	23 1/8	2 5/8	FORD
128608	17	19 13/16	2 5/8	TOYOTA	128676	15 1/2	20 3/8	2 5/8	FORD
128609	15 1/2	23 5/8	2	GMC	128678	15 1/4	23 1/8	1 1/4	VOLVO
128610	17 3/8	20 3/8	1 1/4	FORD	128679	26 3/4	25 7/8	2 5/8	INTERNATIONAL
128611	17 3/8	23 1/8	1 1/4	FORD	128680	27 1/2	17 1/16	2	GMC
128612	18 1/8	22	2	CHRYSLER	128686	28 1/4	27 1/2	2	FORD TRUCK
128613	22 1/2	17 5/8	2 5/8	FORD	128688	15 3/4	24 3/16	2 5/8	TOYOTA
128614	17 3/8	20 3/8	2	FORD	128702	26 1/4	13 3/16	1 1/4	NISSAN
128615	17 3/8	23 1/8	2	FORD	128705	16 1/2	22	1 1/4	ISUZU
128616	16 3/8	17 1/16	1 1/4	FORD	128707	20 3/4	17 3/8	1 9/16	GMC
128617	16 3/8	17 1/16	1 1/4	FORD	128708	16 3/4	20 7/8	1 1/4	TOYOTA
128618	16 3/8	17 1/16	2	FORD	128709	31	25 7/8	2	INTERNATIONAL
128619	20 3/4	17 1/16	2	GMC	128712	31	25 7/8	1 1/4	INTERNATIONAL
128620	17 1/8	22	1 1/4	CHRYSLER	128713	29 3/4	25 7/8	1 1/4	INTERNATIONAL
128621	17 1/2	25 7/8	2	CHRYSLER	128714	16 5/8	24 3/4	2	MERCEDES-BENZ
128623	17 1/2	25 7/8	1 1/4	CHRYSLER	128715	17 1/2	24 3/16	2 5/8	MERCEDES-BENZ
128624	16 3/8	20 3/8	1 1/4	FORD	128719	17 3/4	22 9/16	2	MERCEDES-BENZ
128625	18	25 7/8	2	CHRYSLER	128721	24 1/2	18 3/16	1 9/16	FORD
128626	17 1/2	22	2	CHRYSLER	128723	18 3/16	25 5/16	1 1/4	DODGE
128627	17 1/2	22	2	CHRYSLER	128727	31	11 1/8	1 9/16	JEEP
128628	17 3/8	18 11/16	2	CHRYSLER	128729	15 3/4	16 1/2	1 1/4	CHRYSLER
128629	18	18 11/16	2	CHRYSLER	128731	20 3/4	16 15/16	1 9/16	GMC
128630	16 3/4	22	2	CHRYSLER	128732	26 3/8	17 1/16	2 5/8	GMC
128632	16 1/2	20 7/8	1 1/4	MERCEDES-BENZ	128733	28 1/4	17 1/16	2 5/8	GMC
128633	17 7/8	22	2	DODGE	128735	14	17 5/8	2 5/8	LIFT TRUCKS & LOADERS
128634	15 7/8	25 7/8	2 5/8	JEEP	128736	29	27 1/2	2 5/8	FORD

Vista-Pro Radiator Core Catalog

(Sort by Model)

Model #	Height	Width	Depth	Application	Model #	Height	Width	Depth	Application
128737	13 3/4	15 3/8	1 1/4	SUZUKI	128896	27 3/8	22	2 5/8	VOLVO
128741	30 1/2	17 1/16	2 5/8	GMC	128909	18 1/8	19 13/16	1 1/4	JEEP
128743	24 5/16	26 3/8	2	FORD	128925	23 5/8	31 3/8	2 5/8	FORD TRUCK
128748	30 1/4	25 7/8	2	FORD	128943	14 5/8	23 5/8	1 1/4	MITSUBISHI
128749	30 1/4	25 7/8	2 5/8	FORD	128976	19 1/4	25 7/8	1 1/4	FORD
128750	28 1/4	24 3/16	2	GMC	128978	19 1/4	25 7/8	2	FORD
128751	28 1/4	24 3/16	2 5/8	GMC	129021	29 3/4	25 7/8	2	NAVISTAR
128753	34	24 3/16	2 5/8	GMC	129027	29 3/4	25 7/8	2	NAVISTAR
128756	28 1/4	16 15/16	2 1/4	GMC	129030	12 7/8	25 5/16	2.625	MISC
128758	34	19	1 9/16	GMC	220001	39 1/4	29 1/2	3	PETERBILT
128759	14 1/8	25 5/16	1 1/4	NISSAN	220003	36 1/2	29 1/2	3	PETERBILT
128763	30 1/2	17 3/8	2 1/4	GMC	220035	29 1/4	28 3/4	4 7/16	MILITARY
128764	23 5/8	31 3/8	2 5/8	FORD	220036	43 1/4	46 1/4	2 7/8	MILITARY
128765	25 1/4	22 5/16	2 1/4	MACK TRUCKS	220037	24 3/8	26 15/16	2 5/8	MILITARY
128766	13 3/4	22 9/16	1 1/4	MAZDA	220038	36 1/4	34 3/8	2 3/8	PETERBILT
128767	28 1/4	19 7/16	1 9/16	GMC	221200	25 1/8	25 5/8	3 9/16	AJAX
128772	30 1/2	16 15/16	1 9/16	GMC	221201	35 3/4	33 3/4	3	AJAX
128773	16 1/8	25 5/16	1 1/4	NISSAN	221210	28 1/2	28 1/8	3.75	AJAX
128776	22 1/2	17 1/16	2 5/8	GMC	221211	28 1/2	28 1/8	3	AJAX
128778	17	25 5/16	1 1/4	CHEVROLET	221234	20 1/8	16 1/4	3	JOHN DEERE
128779	26 3/8	17 1/16	1 1/4	GMC	221240	17	13 3/4	2 1/4	JOHN DEERE
128781	18	18 11/16	1 1/4	PLYMOUTH	221245	22 1/2	18 3/4	2 7/8	JOHN DEERE
128782	27 1/2	16 15/16	1 9/16	GMC	221246	24 3/8	20	2 1/4	JOHN DEERE
128785	14 3/4	20 7/8	1 1/4	TOYOTA	221247	26 1/2	20 5/8	2 1/4	JOHN DEERE
128787	16 3/4	20 5/8	1 9/16	TOYOTA	221271	19	20	1 7/8	LINCOLN ELECTRIC
128790	20 1/2	15 3/8	1 1/4	OMNI-HORIZON	221275	16 1/4	16 1/4	2 1/4	INT'L HARVESTER
128791	10 3/4	19 1/4	1 1/4	DATSUN	221276	38 7/8	14 3/8	3 15/16	FLXIBLE BUS
128797	16 3/4	21 1/16	1 9/16	TOYOTA	221277	38 7/8	15 5/8	3 15/16	FLXIBLE BUS
128799	18	20 1/4	1 9/16	MERCEDES-BENZ	221328	15 3/4	16 7/8	1 7/8	FAIRBANKS-MORSE
128800	18 3/8	22	2	CHRYSLER	221343	19	20	1 7/8	CONTINENTAL
128803	28 1/4	19 7/16	2 1/4	GMC	221427	20	18 3/4	2 1/4	AJAX
128804	28 1/4	19	2 1/4	GMC	221428	15 3/4	15 5/8	2 1/4	AJAX
128805	28 1/4	19 7/16	1 9/16	GMC	221472	20	18 3/4	2 3/8	AJAX
128806	28 1/4	19	2 3/4	GMC	221498	13	15	5 1/4	LIFT TRUCKS & LOADERS
128808	16 1/8	24 3/16	2	DATSUN	221499	25 1/2	19 3/8	3 3/4	JOHN DEERE
128809	13 3/8	15 11/16	1	BMW	221500	25 1/8	25	2 1/4	DETROIT DIESEL
128812	11 1/8	14 7/16	1 9/16	AUSTIN	221501	19 3/4	19 3/8	2 1/4	DRESSER INDUSTRIES
128813	15 3/4	18 11/16	2	MERCEDES-BENZ	221502	20 3/8	19 3/8	3	FORD POWER PRODUCTS
128815	17 5/8	17 1/16	2	INTERNATIONAL	221503	17 1/4	15 5/8	2 1/4	FORD TRACTOR
128816	34	19 1/4	2	GMC	221504	17 3/4	16 7/8	2 1/4	FORD TRACTOR
128817	34	16 15/16	2 3/4	GMC	221505	24	22 1/2	3 3/4	INT'L HARVESTER
128818	34	19	2 3/4	GMC	221506	24 3/8	19 3/8	2 1/4	JOHN DEERE
128819	17 1/4	15 3/8	2	AUSTIN	221507	25 1/2	19 3/8	3	JOHN DEERE
128822	17 3/8	17 1/16	2 5/8	JAGUAR	221509	31 1/8	30	3 3/4	FORD TRACTOR
128823	15 3/4	17 1/16	2 5/8	KOMATSU	221510	24 3/8	19 3/8	3	JOHN DEERE
128837	16 5/8	23 5/8	1 1/4	MITSUBISHI	221511	29	25 5/8	3 3/4	DETROIT DIESEL
128839	18 5/8	20 7/8	2	TOYOTA	221513	19 3/4	17 1/2	3	OLIVER HART PARR
128843	18	19 13/16	2	JEEP	221514	34 1/4	27 1/2	3 3/4	JOHN DEERE
128852	18 3/4	27 11/16	1 9/16	DODGE	221515	29 1/4	21 7/8	3 3/4	JOHN DEERE
128853	15 7/8	30 1/8	1 9/16	DODGE	221516	39 3/8	33 3/4	4 5/8	DETROIT DIESEL
128854	29 3/4	25 7/8	2	INTERNATIONAL	221518	17 3/4	18 1/8	3 3/4	FORD TRACTOR
128863	31	25 5/16	2 5/8	GMC	221519	20 1/2	18 1/8	3	JOHN DEERE
128865	31	26	1 9/16	NAVISTAR	221785	17 5/8	17 1/2	2 1/4	FORD TRACTOR
128888	30	29 11/16	2 5/8	GMC	221786	20 1/4	19 3/8	3 3/4	INT'L HARVESTER
128890	31	12 5/8	2	INTERNATIONAL	221787	24 1/2	19 3/8	3	JOHN DEERE

Vista-Pro Radiator Core Catalog

(Sort by Model)

Model #	Height	Width	Depth	Application	Model #	Height	Width	Depth	Application
221788	25	21 1/4	3	JOHN DEERE	223013	17 3/4	15 3/16	2 1/4	CASE/INTERNATIONAL
221789	29 1/4	21 1/4	3 3/4	JOHN DEERE	223014	20 1/4	18 9/16	3	CASE/INTERNATIONAL
221790	29 7/8	26 1/4	3 3/4	JOHN DEERE	223015	22 1/2	23 1/16	3	CASE/INTERNATIONAL
221791	14 1/2	19 3/8	2 1/4	LIFT TRUCKS & LOADERS	223017	23 3/4	22 1/2	3 3/4	CASE/INTERNATIONAL
221792	15 5/8	16 7/8	2 1/4	LIFT TRUCKS & LOADERS	223018	25	24 3/4	3	CATERPILLAR
221793	16 1/8	16 1/4	3	LIFT TRUCKS & LOADERS	223019	25 1/2	26 7/16	2 1/4	CATERPILLAR
221794	17 5/8	16 7/8	2 1/4	LIFT TRUCKS & LOADERS	223020	26 3/4	28 3/4	2 3/8	CATERPILLAR
221795	29 1/4	21 7/8	3 3/4	JOHN DEERE	223021	37 1/2	38 1/4	4 1/2	PETERBILT
221797	25 1/2	19 3/8	3 3/4	JOHN DEERE	223022	20 1/8	21 3/8	3	DRESSER INDUSTRIES
221798	25 1/2	19 3/8	3	JOHN DEERE	223025	24 5/8	28 11/16	3	ADAMS GRADER
221799	24 1/2	19 3/8	2 1/4	JOHN DEERE	223027	27	25 5/16	3 3/4	AJAX
221800	23 1/4	19 3/8	3 3/4	INT'L HARVESTER	223028	35 3/4	34 5/16	3 3/4	AJAX
221801	21 1/2	18 1/8	3	CASE/INTERNATIONAL	223029	33 1/4	31 1/2	3 3/4	AMC
221802	26 3/4	27 1/2	3	CASE/INTERNATIONAL	223035	24 1/8	24 3/4	3	AUSTIN
221803	27	27 1/2	3 3/4	CASE/INTERNATIONAL	223042	26 3/4	28 11/16	3 3/4	CATERPILLAR
221804	15 7/8	15 5/8	2 1/4	CLIMAX	223043	32 1/2	40 1/2	3 3/4	AUTOCAR
221805	25 1/8	25	2 1/4	DETROIT DIESEL	223044	13 1/4	13 1/2	2 1/4	AVERY
221806	14 1/2	15	2 1/4	FIAT ALLIS	223045	14 1/2	15 3/16	2 1/4	AVERY
221807	19 3/8	17 1/2	2 1/4	FIAT ALLIS	223051	25 3/8	19 1/8	3	BOMBARDIER
221808	16	17 1/2	2 1/4	FORD TRACTOR	223057	17 3/4	17 7/16	2 1/4	BROWNHOIST
221809	17 1/4	15 5/8	2 1/4	FORD TRACTOR	223059	27	27	2 1/4	BUCYRUS ERIE
221810	23	19 3/8	3 3/4	INT'L HARVESTER	223060	27	27	3 3/4	BUCYRUS ERIE
221811	24	22 1/2	3	INT'L HARVESTER	223064	45	45	3 3/4	BUCYRUS ERIE
221812	24	22 1/2	3 3/4	INT'L HARVESTER	223067	15	18 9/16	3	CASE/INTERNATIONAL
221813	19 1/8	15	2 1/4	JOHN DEERE	223069	33 1/4	28 11/16	3 3/4	CATERPILLAR
221814	20 1/2	19 3/8	3 3/4	INT'L HARVESTER	223070	38	36	3 3/4	CATERPILLAR
221815	17 1/4	15 5/8	1 7/8	FORD TRACTOR	223071	45 1/2	42 3/4	4 1/2	CATERPILLAR
221816	20 1/4	16 1/4	3 3/4	JOHN DEERE	223072	51	47 13/16	3 3/4	CATERPILLAR
221817	21	16 7/8	3	JOHN DEERE	223073	51	47 13/16	4 1/2	CATERPILLAR
221818	21 1/2	19 3/8	2 1/4	JOHN DEERE	223075	20 5/8	19 11/16	3	GMC
221819	22 1/2	18 1/8	2 1/4	JOHN DEERE	223076	22	28 11/16	3	GMC
221820	24 3/8	19 3/8	3	JOHN DEERE	223078	24	28 11/16	2 1/4	GMC
221821	29	25 5/8	3	DETROIT DIESEL	223081	28 1/4	24 3/16	3	GMC
221822	16	17 1/2	2 1/4	FORD TRACTOR	223083	20 1/4	18 9/16	3	FAIRBANKS-MORSE
221823	19 3/4	19 3/8	2 1/4	LIFT TRUCKS & LOADERS	223084	26	25 7/8	4 1/2	CRANE CARRIER
221824	21 1/4	24 3/8	3	CASE/INTERNATIONAL	223085	42	34 7/8	4 1/2	CUMMINS ENGINE
221826	18	16 1/4	3	INT'L HARVESTER	223086	48	46 1/8	3	CUMMINS ENGINE
221827	21 5/8	18 3/4	3	CASE/INTERNATIONAL	223088	19 3/8	19 1/8	2 1/4	DETROIT DIESEL
221828	24	22 1/2	3	DRESSER INDUSTRIES	223089	24 7/8	24 3/4	2 1/4	DETROIT DIESEL
221834	19 1/4	15 5/8	2 1/4	MASSEY-FERGUSON	223090	24 7/8	24 3/4	2 1/4	DETROIT DIESEL
221835	13 7/8	13 3/4	2 1/4	CLIMAX	223091	29	25 7/8	3	DETROIT DIESEL
221852	15	16 7/8	3	LIFT TRUCKS & LOADERS	223092	29	25 7/8	3 3/4	DETROIT DIESEL
221853	15 7/8	16 1/4	2 1/4	WITTE	223093	30	29 1/4	3	DETROIT DIESEL
221855	19 5/8	16 7/8	2 1/4	LIFT TRUCKS & LOADERS	223095	31 7/8	43 7/8	3 3/4	DETROIT DIESEL
221858	25 3/4	25	3	GALION	223096	34 1/4	34 5/16	4 1/2	DETROIT DIESEL
221860	15	20 5/8	2 1/4	FIAT ALLIS	223097	50	50 1/16	4 1/2	DETROIT DIESEL
221861	30 1/8	26 1/4	3 3/4	JOHN DEERE	223101	21 3/4	25 5/16	1 1/2	DODGE
221900	30 1/2	33 1/8	3 3/4	FLXIBLE BUS	223102	25 3/8	25 5/16	2 1/4	DODGE
222100	25 1/8	25 5/8	3 3/4	AJAX	223104	25 5/8	25 5/16	3	DODGE
223001	35 3/4	34 5/16	3 3/4	AJAX	223105	17	20 13/16	3	CASE/INTERNATIONAL
223005	22 5/8	25 5/16	2 1/4	BARBER-GREENE	223106	17 5/8	18	2 1/4	CASE/INTERNATIONAL
223006	24 7/8	24 3/4	2 1/4	BARBER-GREENE	223108	26 3/4	27 9/16	3	CASE/INTERNATIONAL
223009	16	15 3/4	2 1/4	CASE/INTERNATIONAL	223109	27	27 9/16	3 3/4	CASE/INTERNATIONAL
223010	16 7/8	15 3/4	2 1/4	CASE/INTERNATIONAL	223110	32 1/8	26 7/16	4 1/2	CATERPILLAR
223012	17 1/4	15 3/4	2 1/4	CASE/INTERNATIONAL	223111	34 3/4	26 7/16	4 1/2	CATERPILLAR

Vista-Pro Radiator Core Catalog

(Sort by Model)

Model #	Height	Width	Depth	Application	Model #	Height	Width	Depth	Application
223112	38	38 1/4	4 1/2	CATERPILLAR	223181	24	22 1/2	3	INT'L HARVESTER
223113	38 7/8	34 7/8	4 1/2	CATERPILLAR	223182	32 3/4	25 5/16	4 1/2	INT'L HARVESTER
223114	45	47 13/16	4 1/2	CATERPILLAR	223184	24	22 1/2	3 3/4	INT'L HARVESTER
223115	45 1/2	45	6	CATERPILLAR	223185	17	13 1/2	3	JOHN DEERE
223116	19 1/4	22 1/2	3	LIFT TRUCKS & LOADERS	223186	17 5/8	17 7/16	2 1/4	FORD TRACTOR
223117	25 1/8	25 5/16	2 1/4	DETROIT DIESEL	223187	17 3/4	18	3 3/4	FORD TRACTOR
223118	39 1/4	33 3/4	4 1/2	DETROIT DIESEL	223188	24 1/4	26 7/16	2 1/4	FORD TRUCK
223119	16 1/2	18 9/16	2 1/4	LIFT TRUCKS & LOADERS	223189	24 1/4	26 7/16	3	FORD TRUCK
223120	14 1/2	14 5/8	2 1/4	FIAT ALLIS	223191	16 1/8	15 3/4	2 1/4	INT'L HARVESTER
223121	16 3/4	19 1/8	3	LIFT TRUCKS & LOADERS	223192	17	14 5/8	2 1/4	JOHN DEERE
223122	18 1/4	18	2 1/4	FIAT ALLIS	223193	17 1/4	18	2 1/4	JOHN DEERE
223123	18 1/4	23 1/16	3 3/4	FIAT ALLIS	223194	20	18 9/16	2 1/4	JOHN DEERE
223124	41 5/8	41 5/8	4 1/2	DETROIT DIESEL	223195	20	18 9/16	3	JOHN DEERE
223125	32 3/4	42 3/16	3	GMC	223196	20 1/4	14 1/16	3	JOHN DEERE
223126	25 1/8	25 5/16	3	DETROIT DIESEL	223197	20 1/4	19 11/16	2 1/4	JOHN DEERE
223127	19 3/8	18	2 1/4	FIAT ALLIS	223198	22 1/4	18	2 1/4	JOHN DEERE
223130	16	17 7/16	2 1/4	FORD TRACTOR	223199	20 3/8	15 3/4	3	INT'L HARVESTER
223131	17 1/4	15 3/4	1 1/2	FORD TRACTOR	223200	18 3/8	18	2 1/4	INT'L HARVESTER
223132	18 1/2	15 3/16	2 1/4	MASSEY-FERGUSON	223201	24 5/16	26 7/16	3	FORD TRUCK
223134	17	19 1/8	2 1/4	FIAT ALLIS	223202	21 5/8	20 13/16	3	FORD TRUCK
223135	20 1/4	21 3/8	3	FORD POWER PRODUCTS	223203	22 1/2	18 9/16	2 1/4	JOHN DEERE
223137	24	25 7/8	3	FORD TRUCK	223204	22 1/2	18 9/16	2 1/4	JOHN DEERE
223138	17 1/4	15 3/4	2 1/4	FORD TRACTOR	223205	22 1/2	18 9/16	3	JOHN DEERE
223139	24	25 7/8	3	FORD TRUCK	223206	25	21 3/8	3	JOHN DEERE
223142	17 1/4	15 3/4	2 1/4	FORD TRACTOR	223207	25 1/2	19 11/16	3	JOHN DEERE
223143	28	24 3/16	2 1/4	GALION	223208	27 1/8	21 3/8	3	JOHN DEERE
223144	17 1/2	16 5/16	2 1/4	FORD TRACTOR	223209	27 1/8	21 15/16	3	JOHN DEERE
223146	24 3/8	22 1/2	2 1/4	GARDNER DENVER	223210	29	21 15/16	3 3/4	JOHN DEERE
223147	16	17 7/16	2 1/4	FORD TRACTOR	223211	29 1/8	25 5/16	3 3/4	JOHN DEERE
223148	18 3/8	18	2 1/4	FIAT ALLIS	223212	25 1/2	19 11/16	3	JOHN DEERE
223150	19 1/8	15 3/4	2 1/4	FORD TRACTOR	223214	27 1/8	21 3/8	3 3/4	JOHN DEERE
223151	19 1/2	15 3/16	2 1/4	FORD TRACTOR	223215	32 5/8	27	3 3/4	JOHN DEERE
223153	20 1/2	20 13/16	3 3/4	FORD TRACTOR	223216	14 5/8	19 1/8	3	LIFT TRUCKS & LOADERS
223156	21 7/8	22 1/2	3	FORD TRUCK	223217	14 3/4	19 1/8	2 1/4	LIFT TRUCKS & LOADERS
223157	17 1/4	15 3/4	2 1/4	FORD TRACTOR	223218	13 1/2	15 3/16	3	LIFT TRUCKS & LOADERS
223158	19 1/2	29 1/4	3 3/4	FIAT ALLIS	223220	29 1/4	21 15/16	3 3/4	JOHN DEERE
223160	23 1/4	26 7/16	2 1/4	FORD TRUCK	223221	17	19 1/8	3	LIFT TRUCKS & LOADERS
223161	29 1/2	21 15/16	3	FORD POWER PRODUCTS	223222	17	24 3/16	3	LIFT TRUCKS & LOADERS
223163	17 3/4	19 1/8	3	LIFT TRUCKS & LOADERS	223223	20 1/2	20 13/16	3	LIFT TRUCKS & LOADERS
223164	16 3/4	14 1/16	2 1/4	FORD TRACTOR	223224	29 1/4	25 5/16	3 3/4	JOHN DEERE
223166	24 3/4	21 15/16	3 3/4	FORD TRACTOR	223225	19 5/8	18	2 1/4	LIFT TRUCKS & LOADERS
223167	24 5/16	26 7/16	2 1/4	FORD TRUCK	223226	29	34 5/16	3	MACK TRUCKS
223168	30 1/4	26 7/16	2 1/4	FORD TRUCK	223227	25 1/2	19 11/16	3 3/4	JOHN DEERE
223169	37 7/8	27 9/16	2 1/4	FORD TRUCK	223228	33 15/16	33 3/16	4 1/2	GROVE WORLDWIDE
223170	18	16 5/16	2 1/4	INT'L HARVESTER	223233	19	15 3/16	2 1/4	INT'L HARVESTER
223171	18 3/4	15 3/4	2 1/4	FORD TRACTOR	223234	22 7/16	19 1/8	3	INT'L HARVESTER
223172	19 7/8	19 1/8	2 1/4	LINCOLN ELECTRIC	223235	22 5/8	18 9/16	2 1/4	INT'L HARVESTER
223173	13 3/4	11 13/16	2 1/4	INT'L HARVESTER	223236	22 5/8	18 9/16	2 1/4	INT'L HARVESTER
223174	24 5/16	26 7/16	3	FORD TRUCK	223237	22 11/16	25 5/16	3	INT'L HARVESTER
223175	15	13 1/2	2 1/4	INT'L HARVESTER	223238	29 1/4	21 15/16	3 3/4	JOHN DEERE
223176	16 1/4	16 5/16	2 1/4	INT'L HARVESTER	223239	19 1/2	18	3	LIFT TRUCKS & LOADERS
223177	16 1/2	16 5/16	2 1/4	INT'L HARVESTER	223240	15 3/4	16 5/16	3	LIFT TRUCKS & LOADERS
223178	20 3/8	19 11/16	3 3/4	INT'L HARVESTER	223242	35	39 15/16	4 1/2	KENWORTH
223179	17 5/8	17 7/16	2 1/4	FORD TRACTOR	223243	26 7/16	29 1/4	4 1/2	GROVE WORLDWIDE
223180	16 1/4	16 5/16	3	INT'L HARVESTER	223244	15 3/4	15 3/4	2 1/4	CASE/INTERNATIONAL

Vista-Pro Radiator Core Catalog

(Sort by Model)

Model #	Height	Width	Depth	Application	Model #	Height	Width	Depth	Application
223246	16 1/4	17 7/16	2 1/4	LIFT TRUCKS & LOADERS	223601	39 1/4	33 3/4	3	DETROIT DIESEL
223247	37 9/16	43 5/16	4 1/2	CATERPILLAR	223604	15	15 3/16	2 1/4	JOHN DEERE
223248	16 3/4	26 7/16	5 1/4	PETTIBONE	223605	15 3/8	18 9/16	3	LIFT TRUCKS & LOADERS
223249	16 7/8	15 3/16	2 1/4	MASSEY-FERGUSON	223608	15 3/4	19 11/16	3	LIFT TRUCKS & LOADERS
223250	17	15 3/16	2 1/4	JOHN DEERE	223610	39 1/4	33 3/4	3 3/4	DETROIT DIESEL
223251	17	19 1/8	3	LIFT TRUCKS & LOADERS	223611	19 1/8	18	2 1/4	MASSEY-FERGUSON
223252	17 1/2	16 5/16	2 1/4	OLIVER HART PARR	223612	19 1/4	18	2 1/4	MINNEAPOLIS MOLINE
223253	19 7/8	18	4 1/2	JOHN DEERE	223613	20 1/4	16 5/16	4 1/2	JOHN DEERE
223254	37 1/2	46 1/8	2 1/4	JOY MANUFACTURING	223614	24 1/2	27	3	JOHN DEERE
223258	14 1/2	19 11/16	2 1/4	LIFT TRUCKS & LOADERS	223615	30	29 1/4	5 1/4	JOHN DEERE
223259	15 7/8	14 5/8	2 1/4	LIFT TRUCKS & LOADERS	223616	34	16 5/16	5 1/4	JOHN DEERE
223261	37 9/16	43 5/16	4 1/2	CATERPILLAR	223617	39 1/2	33 3/4	4 1/2	DETROIT DIESEL
223262	16 1/2	14 1/16	2 1/4	JOHN DEERE	223618	39 1/4	33 3/4	3 3/4	DETROIT DIESEL
223263	16 7/8	16 5/16	2 1/4	OLIVER HART PARR	223619	21 3/4	18	2 1/4	FIAT ALLIS
223264	17	17 7/16	2 1/4	LIFT TRUCKS & LOADERS	223620	25 3/8	35 7/16	3 3/4	EUCLID
223265	17 3/8	15 3/4	2 1/4	MASSEY-FERGUSON	223621	45	47 13/16	3 3/4	CATERPILLAR
223266	19 3/8	17 7/16	2 1/4	MINNEAPOLIS MOLINE	223622	34	16 5/16	5 1/4	JOHN DEERE
223267	19 1/2	23 1/16	3 3/4	CASE/INTERNATIONAL	223624	26 1/2	28 11/16	3	CATERPILLAR
223269	20	20 1/4	2 1/4	HOBART WELDER	223625	32	37 11/16	4 1/2	EAGLE COACH
223270	20	20 1/4	3	HOBART WELDER	223626	16 1/4	17 7/16	2 1/4	FIAT ALLIS
223271	54 1/8	55 1/8	4 1/2	MANITOWOC	223627	22 1/8	24 3/4	4 1/2	JOHN DEERE
223274	20 1/2	15 3/4	3 3/4	CASE/INTERNATIONAL	223628	16	17 7/16	2 1/4	FORD TRACTOR
223275	24	24 3/16	2 1/4	NAVISTAR	223630	31 5/8	21 7/8	3 15/16	GILLIG BUS
223276	29 3/8	26 7/16	3	NAVISTAR	223631	36 1/4	20	4 7/16	NEW FLYER BUS
223278	21 9/16	23 1/16	2 1/4	SULLAIR	224502	32 1/2	22 1/2	2.375	PETERBILT
223280	23 1/4	21 3/8	3	OLIVER HART PARR	225000	17 1/8	18 1/8	2 15/16	CASE/INTERNATIONAL
223283	23	18 9/16	2 1/4	JOHN DEERE	225001	19 1/4	20 5/8	3 11/16	CASE/INTERNATIONAL
223284	24 5/16	26 7/16	3	FORD TRUCK	225002	26 1/4	27 1/2	4 7/16	CASE/INTERNATIONAL
223285	24 3/4	24 3/16	3	NAVISTAR	225003	27 15/16	25	4 7/16	CASE/INTERNATIONAL
223289	28	28 11/16	3 3/4	EUCLID	225005	30 1/2	16 1/4	4 7/16	CASE/INTERNATIONAL
223294	31 3/4	27 9/16	3	NAVISTAR	225006	31 1/16	17 1/2	4 7/16	CASE/INTERNATIONAL
223295	33 1/2	26 7/16	3	NAVISTAR	225007	31 1/8	27 1/2	4 7/16	CASE/INTERNATIONAL
223297	34 1/2	28 1/8	4 1/2	FREIGHTLINER	225008	32 1/2	30 5/8	4 7/16	CASE/INTERNATIONAL
223299	35 3/4	33 3/4	3 3/4	MANITOWOC	225011	32 3/4	25	4 7/16	CASE/INTERNATIONAL
223300	36	33 3/16	3 3/4	WAUKESHA	225012	35 13/16	20 5/8	4 7/16	CASE/INTERNATIONAL
223302	37 3/16	32 5/8	3	NAVISTAR	225015	37 9/16	25	3 11/16	CASE/INTERNATIONAL
223303	37 1/8	39 15/16	3	NAVISTAR	225016	37 9/16	25	5 3/16	CASE/INTERNATIONAL
223304	37 7/8	27 9/16	3	FORD TRUCK	225021	20 15/16	42 1/2	4 7/16	CATERPILLAR
223307	39 1/4	29 13/16	4 1/2	KENWORTH	225023	30	30 5/8	4 7/16	CATERPILLAR
223310	48 1/2	37 1/8	5 1/4	V.M.E.	225026	22 5/8	18 1/8	2 15/16	CATERPILLAR
223311	50	62 7/16	2 1/4	GARDNER DENVER	225031	22 5/8	22 1/2	2 3/16	CATERPILLAR
223312	51	51 3/16	3 3/4	JOY MANUFACTURING	225033	45 1/2	42 1/2	4 7/16	CATERPILLAR
223316	26 5/8	24 3/4	3 3/4	WAUKESHA	225035	20 7/8	20 5/8	2 15/16	CATERPILLAR
223323	20 1/4	22 1/2	2 1/4	FORD TRUCK	225036	22 5/8	22 1/2	2 15/16	CATERPILLAR
223324	19 1/8	48 15/16	6	CROWN COACH	225037	44 3/8	36 1/4	6	CATERPILLAR
223587	32	31 1/2	3 3/4	DRESSER INDUSTRIES	225038	23 1/2	18 3/4	2 3/16	CATERPILLAR
223588	39 1/4	22 1/2	6	LIFT TRUCKS & LOADERS	225039	23 7/16	24 3/8	2 15/16	CATERPILLAR
223589	18 1/2	19 1/8	3	ELGIN	225042	23 1/2	18 3/4	2 15/16	CATERPILLAR
223591	25 1/4	35 7/16	4 1/2	EUCLID	225044	39	30	6	CATERPILLAR
223593	38 1/8	39 15/16	4 1/2	EUCLID	225045	40 7/16	30 5/8	6	CATERPILLAR
223594	44	47 1/4	4 1/2	V.M.E.	225047	33 5/8	33 1/8	2 15/16	CATERPILLAR
223595	46	66 3/8	4 1/2	EUCLID	225048	30	35 5/8	2 15/16	CATERPILLAR
223597	14	14 5/8	2 1/4	FIAT ALLIS	225051	32	35 5/8	4 7/16	CATERPILLAR
223598	16 1/2	18	2 1/4	FIAT ALLIS	225052	42 13/16	40	4 7/16	CATERPILLAR
223600	39 1/4	33 3/4	3 3/4	DETROIT DIESEL	225053	52	51 1/4	4 7/16	CATERPILLAR

Vista-Pro Radiator Core Catalog

(Sort by Model)

Model #	Height	Width	Depth	Application	Model #	Height	Width	Depth	Application
225054	52 1/8	51 1/4	4 7/16	CATERPILLAR	225182	40	37 1/2	6	CATERPILLAR
225055	38	31 7/8	4 7/16	CATERPILLAR	225183	29 5/8	31 7/8	4 7/16	DRESSER INDUSTRIES
225061	30	35 5/8	4 7/16	CATERPILLAR	225184	42 13/16	34 3/8	3 11/16	CATERPILLAR
225065	48 5/16	47 1/2	4 7/16	CATERPILLAR	225186	26 3/4	24 3/8	3 11/16	CATERPILLAR
225066	48 5/16	47 1/2	6	CATERPILLAR	225189	29 5/8	33 1/8	2 15/16	CATERPILLAR
225068	39 1/16	37 1/2	6	CATERPILLAR	225191	45 3/4	25 5/8	4 7/16	CATERPILLAR
225069	51 1/4	46 1/4	5 3/16	CATERPILLAR	225192	54 1/8	50 5/8	5 3/16	CATERPILLAR
225073	33 5/8	33 1/8	3 11/16	CATERPILLAR	225193	48 1/4	47 1/2	5 3/16	CATERPILLAR
225074	42	40	4 7/16	CATERPILLAR	225194	34 3/4	31 1/4	4 7/16	CATERPILLAR
225075	48 5/16	47 1/2	5 3/16	CATERPILLAR	225195	45	48 1/8	4 7/16	CATERPILLAR
225078	38 5/16	30	4 7/16	CATERPILLAR	225196	45	48 1/8	3 11/16	CATERPILLAR
225079	33 7/16	21 1/4	4 7/16	CATERPILLAR	225197	45	48 1/8	5 3/16	CATERPILLAR
225080	39	45	5 3/16	CATERPILLAR	225200	51	48 1/8	4 7/16	CATERPILLAR
225081	34 3/4	26 7/8	4 7/16	CATERPILLAR	225201	44 15/16	38 3/4	6	CATERPILLAR
225082	39 7/16	22 1/2	6	CATERPILLAR	225202	44 15/16	38 3/4	5 3/16	CATERPILLAR
225085	51 1/4	46 1/4	6	CATERPILLAR	225203	45 5/16	43 3/4	3 11/16	CATERPILLAR
225086	41	37 1/2	6	CATERPILLAR	225204	41 9/16	21 1/4	3 11/16	CATERPILLAR
225088	42 1/8	40	3 11/16	CATERPILLAR	225207	45 1/2	42 1/2	3 11/16	CATERPILLAR
225089	43 1/2	39 3/8	4 7/16	CATERPILLAR	225214	28	20	4 7/16	JOHN DEERE
225093	45 1/2	42 1/2	4 7/16	CATERPILLAR	225218	39 5/8	41 7/8	6	DRESSER INDUSTRIES
225094	42	40	2 15/16	CATERPILLAR	225219	38	31 7/8	5 3/16	CATERPILLAR
225107	33 3/4	27 1/2	2 15/16	CATERPILLAR	225223	33 7/16	27 1/2	2 3/16	CATERPILLAR
225113	38	31 7/8	3 11/16	CATERPILLAR	225225	54 1/8	50 5/8	6	CATERPILLAR
225114	42 1/8	40	5 3/16	CATERPILLAR	225226	58 5/8	57 1/2	6	CATERPILLAR
225117	42 13/16	40	4 7/16	CATERPILLAR	225228	45 3/4	25 5/8	5 3/16	CATERPILLAR
225119	28 1/4	29 3/8	2 15/16	CATERPILLAR	225229	45 3/4	25 5/8	3 11/16	CATERPILLAR
225121	45 1/2	45	6	CATERPILLAR	225230	23 7/16	24 3/8	2 15/16	CATERPILLAR
225122	42 13/16	40 5/8	3 11/16	CATERPILLAR	225235	25 15/16	20 5/8	2 15/16	CATERPILLAR
225123	37 3/4	27 1/2	4 7/16	CATERPILLAR	225238	26	27 1/2	2 15/16	CATERPILLAR
225124	40 3/8	25 5/8	6	CATERPILLAR	225240	26	28 3/4	4 7/16	CATERPILLAR
225125	30	26 7/8	4 7/16	CATERPILLAR	225241	26 3/4	24 3/8	2 15/16	CATERPILLAR
225129	21 3/4	21 1/4	4 7/16	CATERPILLAR	225242	26 3/4	26 1/4	2 3/16	CATERPILLAR
225134	26 3/4	26 1/4	2 15/16	CATERPILLAR	225244	27 3/4	25 5/8	2 15/16	CATERPILLAR
225135	27 3/4	25 5/8	3 11/16	CATERPILLAR	225245	28	27 1/2	2 3/16	CATERPILLAR
225137	35 3/4	22 1/2	5 3/16	CATERPILLAR	225246	28	27 1/2	2 15/16	CATERPILLAR
225139	26 3/8	20	2 15/16	CATERPILLAR	225247	28	27 1/2	3 11/16	CATERPILLAR
225141	34	33 1/8	5 3/16	CATERPILLAR	225248	28 1/4	24 3/8	2 15/16	CATERPILLAR
225143	48 1/4	47 1/2	6	CATERPILLAR	225249	29 1/4	16 1/4	3 11/16	CATERPILLAR
225145	52	51 1/4	6	CATERPILLAR	225250	29 1/4	16 1/4	4 7/16	CATERPILLAR
225146	43 1/2	39 3/8	5 3/16	CATERPILLAR	225253	29 5/8	33 1/8	2 3/16	CATERPILLAR
225147	37 9/16	43 1/8	4 7/16	CATERPILLAR	225256	18	21 1/4	2 15/16	CASE/INTERNATIONAL
225148	43 1/2	39 3/8	4 7/16	CATERPILLAR	225260	20 1/8	18 3/4	2 15/16	AJAX
225152	35 3/4	22 1/2	4 7/16	CATERPILLAR	225261	25 1/8	25	3 11/16	AJAX
225154	28	26 7/8	3 11/16	JOHN DEERE	225263	39	35 5/8	4 7/16	AJAX
225155	45 1/2	45	4 7/16	CATERPILLAR	225291	30 1/4	28 3/4	3 11/16	CATERPILLAR
225156	45 1/4	45	3 11/16	CATERPILLAR	225295	32 1/8	26 7/8	3 11/16	CATERPILLAR
225158	28 1/4	24 3/8	4 7/16	CATERPILLAR	225298	33 7/16	33 1/8	2 3/16	CATERPILLAR
225161	58 1/2	57 1/2	6	CATERPILLAR	225299	33 7/16	33 1/8	2 15/16	CATERPILLAR
225162	45 1/4	45	6	CATERPILLAR	225309	31 7/16	40	3 11/16	OSHKOSH
225165	44 5/16	40	6	CATERPILLAR	225310	28 9/16	28 3/4	4 7/16	GALION
225166	58 5/8	57 1/2	5 3/16	CATERPILLAR	225313	15	18 1/8	2 15/16	CASE/INTERNATIONAL
225171	42	40	5 3/16	CATERPILLAR	225314	15 1/4	18 1/8	2 15/16	CASE/INTERNATIONAL
225175	37 1/2	37 1/2	4 7/16	CATERPILLAR	225315	15 7/8	15 5/8	2 3/16	CASE/INTERNATIONAL
225178	47 1/2	43 1/8	5 3/16	CATERPILLAR	225316	16 1/4	18 1/8	2 15/16	CASE/INTERNATIONAL
225181	51	60	4 7/16	CATERPILLAR	225317	16 7/8	15 5/8	2 3/16	CASE/INTERNATIONAL

Vista-Pro Radiator Core Catalog

(Sort by Model)

Model #	Height	Width	Depth	Application	Model #	Height	Width	Depth	Application
225320	17 5/8	18 1/8	2 3/16	CASE/INTERNATIONAL	225453	33 3/4	68 3/4	3 11/16	CUMMINS ENGINE
225321	18 1/4	23 1/8	3 11/16	CASE/INTERNATIONAL	225456	36	32 1/2	3 11/16	CUMMINS ENGINE
225322	19	23 1/8	2 3/16	CASE/INTERNATIONAL	225458	18 3/8	18 1/8	2 3/16	INT'L HARVESTER
225324	20 1/2	15	2 3/16	CASE/INTERNATIONAL	225459	20 1/4	16 1/4	2 15/16	INT'L HARVESTER
225331	22 3/4	18 1/8	2 15/16	CASE/INTERNATIONAL	225460	24	22 1/2	3 11/16	INT'L HARVESTER
225332	23 3/4	22 1/2	3 11/16	CASE/INTERNATIONAL	225461	17 1/4	18 1/8	2 3/16	JOHN DEERE
225333	24 1/16	24 3/8	4 7/16	CASE/INTERNATIONAL	225463	17 3/4	14 3/8	2 15/16	JOHN DEERE
225334	24 1/8	24 3/8	4 7/16	CASE/INTERNATIONAL	225464	20	18 1/8	2 15/16	JOHN DEERE
225337	27 1/2	25 5/8	4 7/16	CASE/INTERNATIONAL	225465	20 1/4	13 3/4	2 15/16	JOHN DEERE
225339	30 1/4	30	4 7/16	CASE/INTERNATIONAL	225466	20 1/8	16 1/4	4 7/16	JOHN DEERE
225341	32	27 1/2	4 7/16	CASE/INTERNATIONAL	225467	20 1/8	19 3/8	2 3/16	JOHN DEERE
225350	26 3/4	28 3/4	3 11/16	CATERPILLAR	225468	20 1/8	19 3/8	2 15/16	JOHN DEERE
225355	29 5/16	29 3/8	4 7/16	CATERPILLAR	225469	21 1/2	13 3/4	2 15/16	JOHN DEERE
225358	30 1/2	24 3/8	4 7/16	CATERPILLAR	225472	32 5/8	26 7/8	3 11/16	JOHN DEERE
225359	30 1/2	26 1/4	4 7/16	CATERPILLAR	225473	13	15	5 3/16	LIFT TRUCKS & LOADERS
225360	30 9/16	33 1/8	3 11/16	CATERPILLAR	225474	13 7/8	17 1/2	2 15/16	LIFT TRUCKS & LOADERS
225367	32	31 7/8	4 7/16	CATERPILLAR	225476	38	36 1/4	3 11/16	CUMMINS ENGINE
225368	32 1/8	26 7/8	4 7/16	CATERPILLAR	225477	17	19 3/8	2 15/16	LIFT TRUCKS & LOADERS
225372	33	28 3/4	4 7/16	CATERPILLAR	225478	30 1/2	28 3/4	4 7/16	FORD TRACTOR
225379	33 7/16	33 1/8	3 11/16	CATERPILLAR	225482	18 3/4	15 5/8	2 3/16	MASSEY-FERGUSON
225382	35 15/16	36 1/4	4 7/16	CATERPILLAR	225485	43 1/2	43 3/4	6	TEREX
225383	36 13/16	40	4 7/16	CATERPILLAR	225486	19 5/8	18 1/8	2 3/16	LIFT TRUCKS & LOADERS
225386	38	36 1/4	4 7/16	CATERPILLAR	225487	42	35	4 7/16	CUMMINS ENGINE
225389	38	34 3/8	4 7/16	CATERPILLAR	225489	38 3/4	28 3/4	5 3/16	FORD TRACTOR
225390	38	37 1/2	4 7/16	CATERPILLAR	225491	18 3/4	17 1/2	2 3/16	LIFT TRUCKS & LOADERS
225395	38	36 1/4	5 3/16	CATERPILLAR	225494	20 1/4	16 1/4	4 7/16	JOHN DEERE
225397	42 7/8	42 1/2	3 11/16	CATERPILLAR	225495	35 3/4	37 1/2	4 7/16	FIAT ALLIS
225399	40	41 7/8	4 7/16	CATERPILLAR	225499	30	29 3/8	3 11/16	FIAT ALLIS
225400	46	45	5 3/16	CATERPILLAR	225507	17	13 3/4	2 15/16	JOHN DEERE
225401	48 1/4	47 1/2	6	CATERPILLAR	225508	20 1/4	16 1/4	3 11/16	JOHN DEERE
225402	16 1/2	18 3/4	2 3/16	LIFT TRUCKS & LOADERS	225514	39 3/8	33 3/4	3 11/16	DETROIT DIESEL
225404	51	48 1/8	3 11/16	CATERPILLAR	225516	25 1/4	25 5/8	3 11/16	DROTT
225410	28	28 3/4	3 11/16	TEREX	225518	38 1/2	41 1/4	4 7/16	FIAT ALLIS
225413	29	25 5/8	2 15/16	DETROIT DIESEL	225519	27 15/16	25	2 15/16	INT'L HARVESTER
225414	29	25 5/8	3 11/16	DETROIT DIESEL	225520	15 3/4	16 7/8	2 15/16	LIFT TRUCKS & LOADERS
225418	19 7/8	19 3/8	2 3/16	CONTINENTAL	225524	39 1/2	33 3/4	4 7/16	DETROIT DIESEL
225422	48	46 1/4	4 7/16	CUMMINS ENGINE	225525	17 3/4	19 3/8	2 3/16	LIFT TRUCKS & LOADERS
225425	26 7/16	31 7/8	3 11/16	EMD LOCOMOTIVE	225526	18	16 1/4	2 3/16	INT'L HARVESTER
225426	18 1/4	18 1/8	2 3/16	FIAT ALLIS	225534	27	21 7/8	3 11/16	JOHN DEERE
225428	34	15 5/8	5 3/16	JOHN DEERE	225536	60	53 3/4	4 7/16	DETROIT DIESEL
225431	59 1/2	60	4 7/16	CUMMINS ENGINE	225537	47 1/2	40	6	CATERPILLAR
225432	16 3/4	13 3/4	2 3/16	FORD TRACTOR	225538	40	37 1/2	4 7/16	CATERPILLAR
225434	17 1/4	15	2 3/16	FORD TRACTOR	225541	18	16 1/4	2 3/16	INT'L HARVESTER
225435	35	34 3/8	2 15/16	CUMMINS ENGINE	225549	38	36 1/4	3 11/16	CATERPILLAR
225436	15	13 3/4	2 3/16	INT'L HARVESTER	225570	13 1/8	15 5/8	5 3/16	LIFT TRUCKS & LOADERS
225437	53 3/8	52 1/2	4 7/16	CUMMINS ENGINE	225609	28 1/4	29 3/8	2 15/16	CATERPILLAR
225439	54	53 1/8	4 7/16	CUMMINS ENGINE	225611	33 3/4	27 1/2	3 11/16	CATERPILLAR
225440	17 1/4	15 5/8	2 3/16	FORD TRACTOR	225615	22 1/8	25	4 7/16	JOHN DEERE
225442	17 1/4	15 5/8	2 3/16	FORD TRACTOR	225616	22 1/2	25	3 11/16	CASE/INTERNATIONAL
225443	17 1/2	16 1/4	2 3/16	FORD TRACTOR	225617	30	29 3/8	5 3/16	JOHN DEERE
225444	13 3/4	11 7/8	2 3/16	INT'L HARVESTER	225621	47 1/4	43 3/4	5 3/16	KOMATSU
225448	30	30	3 11/16	CUMMINS ENGINE	225624	43	36 1/4	6	DRESSER INDUSTRIES
225449	16 1/8	15 5/8	2 3/16	INT'L HARVESTER	225631	32 7/8	20	5 3/16	JOHN DEERE
225450	16 1/4	16 1/4	2 15/16	INT'L HARVESTER	225632	32 7/8	20 5/8	6	JOHN DEERE
225452	16 1/2	16 1/4	2 3/16	INT'L HARVESTER	225633	38	16 1/4	5 3/16	JOHN DEERE

Vista-Pro Radiator Core Catalog

(Sort by Model)

Model #	Height	Width	Depth	Application	Model #	Height	Width	Depth	Application
225635	33 1/4	30	4 7/16	KOMATSU	225871	45 1/2	45	6	CATERPILLAR
225639	40	47 1/2	4 7/16	EUCLID	225873	44 5/16	40	6	CATERPILLAR
225643	37 1/8	37 1/2	5 3/16	DRESSER INDUSTRIES	225874	34 3/4	31 1/4	4 7/16	CATERPILLAR
225645	28	20	4 7/16	JOHN DEERE	225875	35 3/4	22 1/2	5 3/16	CATERPILLAR
225647	24 5/8	17 1/2	6	MOTOR COACH IND (MCI)	225877	45 1/2	42 1/2	4 7/16	CATERPILLAR
225688	14 1/4	19 1/2	3	LIFT TRUCKS & LOADERS	225878	54 1/8	50 5/8	5 3/16	CATERPILLAR
225689	17 5/8	16 7/8	2 3/8	LIFT TRUCKS & LOADERS	225879	58 5/8	57 1/2	5 3/16	CATERPILLAR
225691	18 7/8	19	3	LIFT TRUCKS & LOADERS	225883	29 1/4	16 1/4	3 11/16	CATERPILLAR
225692	19 1/8	18	3	LIFT TRUCKS & LOADERS	225886	29 5/16	29 3/8	5 3/16	CATERPILLAR
225693	19 5/8	16 7/8	2 3/8	LIFT TRUCKS & LOADERS	225888	30 1/2	26 1/4	4 7/16	CATERPILLAR
225702	36 1/4	33 1/8	3 7/16	NABI BUS	225891	29 1/4	16 1/4	4 7/16	CATERPILLAR
225703	38 7/8	15 5/8	3 15/16	NABI BUS	225893	33 7/16	27 1/2	3 11/16	CATERPILLAR
225704	38 7/8	14 3/8	3 15/16	NABI BUS	225895	33 7/16	33 1/8	2 15/16	CATERPILLAR
225705	42	19 3/8	4 7/16	GMC	225896	33 7/16	33 1/8	2 3/16	CATERPILLAR
225801	20 7/8	20 5/8	2 15/16	CATERPILLAR	225898	28	27 1/2	3 11/16	CATERPILLAR
225804	27 3/4	21 1/4	5 3/16	CATERPILLAR	225899	58 5/8	57 1/2	6	CATERPILLAR
225805	27 3/4	25 5/8	3 11/16	CATERPILLAR	225905	42 1/8	40	3 11/16	CATERPILLAR
225808	28 1/4	29 3/8	2 3/16	CATERPILLAR	225907	42 1/8	40	5 3/16	CATERPILLAR
225809	30	35 5/8	4 7/16	CATERPILLAR	225909	38	31 7/8	3 11/16	CATERPILLAR
225812	39 7/16	22 1/2	6	CATERPILLAR	225912	42	39 3/8	2 3/16	CATERPILLAR
225813	39 5/8	41 7/8	6	DRESSER INDUSTRIES	225914	46 1/2	48 1/8	6	CATERPILLAR
225814	41 9/16	21 1/4	3 11/16	CATERPILLAR	225915	47 1/2	43 3/4	4 7/16	CATERPILLAR
225815	43 1/2	39 3/8	4 7/16	CATERPILLAR	225918	48 5/16	47 1/2	5 3/16	CATERPILLAR
225816	44 15/16	38 3/4	6	CATERPILLAR	225919	28	26 7/8	3 11/16	JOHN DEERE
225819	45 5/16	43 3/4	3 11/16	CATERPILLAR	225920	34	17 1/2	5 3/16	JOHN DEERE
225820	45 1/2	42 1/2	4 7/16	CATERPILLAR	225921	39 5/8	41 1/4	6	DRESSER INDUSTRIES
225821	48 1/4	47 1/2	4 7/16	CATERPILLAR	225925	47 1/4	43 3/4	5 3/16	KOMATSU
225822	51 1/4	46 1/4	6	CATERPILLAR	225928	45 3/4	25 5/8	3 11/16	CATERPILLAR
225823	39	45	5 3/16	CATERPILLAR	225929	43 1/2	39 3/8	2 15/16	CATERPILLAR
225829	48 1/4	47 1/2	5 3/16	CATERPILLAR	225930	52 1/8	51 1/4	4 7/16	CATERPILLAR
225830	45 1/4	45	5 3/16	CATERPILLAR	225931	32 3/16	28 3/4	5 3/16	JOHN DEERE
225831	42	40	5 3/16	CATERPILLAR	225932	38	16 1/4	5 3/16	JOHN DEERE
225832	40 3/8	25 5/8	6	CATERPILLAR	225933	48 3/4	38 1/8	5 3/16	JOHN DEERE
225833	37 1/2	37 1/2	4 7/16	CATERPILLAR	225934	26 5/8	25	3 11/16	KOMATSU
225835	28 1/4	29 3/8	2 15/16	CATERPILLAR	225937	33 1/4	30	4 7/16	KOMATSU
225836	30	26 7/8	4 7/16	CATERPILLAR	225939	29 5/8	31 7/8	4 7/16	DRESSER INDUSTRIES
225838	33 7/16	21 1/4	4 7/16	CATERPILLAR	225940	38	16 1/4	5 3/16	JOHN DEERE
225839	33 3/4	27 1/2	3 11/16	CATERPILLAR	225941	32 7/8	20 5/8	6	JOHN DEERE
225841	34	33 1/8	5 3/16	CATERPILLAR	225942	32 7/8	20	5 3/16	JOHN DEERE
225843	38	33 1/8	4 7/16	CATERPILLAR	225943	28	20	4 7/16	JOHN DEERE
225844	42 13/16	34 3/8	3 11/16	CATERPILLAR	225944	28	20	4 7/16	JOHN DEERE
225845	42 13/16	40	4 7/16	CATERPILLAR	225945	22 1/8	25	4 7/16	JOHN DEERE
225846	44 3/8	36 1/4	6	CATERPILLAR	225946	58 1/2	57 1/2	2 3/16	CATERPILLAR
225847	30 1/2	24 3/8	4 7/16	CATERPILLAR	225947	48 5/16	47 1/2	4 7/16	CATERPILLAR
225848	32	35 5/8	4 7/16	CATERPILLAR	225948	45 3/4	25 5/8	5 3/16	CATERPILLAR
225850	29 5/8	33 1/8	2 15/16	CATERPILLAR	225950	42	36 1/4	6	DRESSER INDUSTRIES
225854	47 1/2	43 1/8	5 3/16	CATERPILLAR	225951	39	34 3/8	2 15/16	KOMATSU
225855	48 1/4	47 1/2	6	CATERPILLAR	225963	43	36 1/4	6	DRESSER INDUSTRIES
225856	52	51 1/4	4 7/16	CATERPILLAR	225964	31 3/4	40 5/8	2 3/8	VOLVO
225857	26	27 1/2	2 3/16	CATERPILLAR	226000	43 1/4	33 1/8	2 3/8	FORD TRUCK
225860	42 13/16	40 5/8	4 7/16	CATERPILLAR	226001	30	43 1/8	2 3/8	GMC
225863	38	31 7/8	4 7/16	CATERPILLAR	226002	29	40 5/8	2 7/8	FREIGHTLINER
225864	42 13/16	40	2 15/16	CATERPILLAR	226003	32 3/16	25 5/8	2 7/8	NAVISTAR
225866	50	37 1/2	6	CATERPILLAR	226004	32 3/4	28 3/4	2 7/8	KENWORTH
225868	45 3/4	25 5/8	4 7/16	CATERPILLAR	226005	38 5/8	34 3/8	2 3/8	MACK TRUCKS

Vista-Pro Radiator Core Catalog

(Sort by Model)

Model #	Height	Width	Depth	Application	Model #	Height	Width	Depth	Application
226006	29 1/4	34 3/8	2 7/8	PETERBILT	226129	20 1/8	19 3/8	2 3/8	DIVCO
226007	29	40 5/8	2 3/8	VOLVO	226130	36 1/4	33 1/8	3 7/16	GMC
226008	32 1/2	35 5/8	2 7/8	WESTERN STAR	226131	22	25 5/8	2 3/8	DODGE
226009	38 5/8	34 3/8	2 7/8	MACK TRUCKS	226134	33	26 1/4	2 3/8	DODGE
226010	31 3/4	40 5/8	2 3/8	VOLVO	226135	30 3/8	34 3/8	2 7/8	MACK TRUCKS
226011	37 1/2	38 1/8	2 7/8	PETERBILT	226137	37 1/4	30 5/8	2 3/8	MACK TRUCKS
226013	39 15/16	28 1/8	2 7/8	NAVISTAR	226138	37 5/8	25	2 3/8	NAVISTAR
226014	37	32 1/2	2 3/8	FREIGHTLINER	226139	23	26 1/4	1 3/4	FORD TRUCK
226015	32 3/4	42 1/2	2 3/8	GMC	226140	39 3/4	30	2 3/8	NAVISTAR
226016	32 3/4	42 1/2	2 7/8	GMC	226141	23 3/8	26 1/4	1 3/4	FORD TRUCK
226017	39 3/4	30	2 7/8	NAVISTAR	226142	39 3/4	30	2 7/8	NAVISTAR
226018	44	34 3/8	2 7/8	MACK TRUCKS	226143	40	28 3/4	2 3/8	KENWORTH
226020	35 1/2	40 5/8	2 3/8	VOLVO	226144	39 15/16	29 3/8	2 3/8	NAVISTAR
226023	39 15/16	35 5/8	2 7/8	NAVISTAR	226145	24 1/4	26 1/4	1 3/4	FORD TRUCK
226024	38	35	2 3/8	VOLVO	226146	39 15/16	35 5/8	2 3/8	NAVISTAR
226025	44	27 1/2	2 7/8	GMC	226147	42 3/4	28 1/8	2 3/8	NAVISTAR
226026	42 3/4	28 1/8	2 7/8	NAVISTAR	226148	24 5/16	26 1/4	2 7/8	FORD TRUCK
226027	37 7/8	27 1/2	2 7/8	FORD TRUCK	226149	36 1/4	34 3/8	2 3/8	PETERBILT
226028	37 1/2	28 1/8	2 3/8	FORD TRUCK	226150	27 3/4	29 3/8	2 7/8	FORD TRUCK
226029	38	35	2 7/8	VOLVO	226151	32 1/2	35 5/8	2 3/8	WESTERN STAR
226030	36 1/4	34 3/8	2 7/8	PETERBILT	226152	30 1/4	26 1/4	1 3/4	FORD TRUCK
226031	37 7/8	27 1/2	2 3/8	FORD TRUCK	226153	30 1/4	26 1/4	2 3/8	FORD TRUCK
226032	40	28 3/4	2 7/8	KENWORTH	226154	29	34 3/8	2 3/8	MACK TRUCKS
226033	37	32 1/2	2 7/8	FREIGHTLINER	226156	37 7/8	27 1/2	2 7/8	FORD TRUCK
226034	39 3/4	30	2 3/8	NAVISTAR	226157	37 1/2	28 1/8	3 7/16	FREIGHTLINER
226035	39 15/16	28 1/8	2 3/8	NAVISTAR	226161	38 1/2	31 1/4	2 7/8	FORD TRUCK
226036	42 3/4	28 1/8	2 3/8	NAVISTAR	226162	33	29 3/8	2 3/8	NAVISTAR
226037	24 3/8	27 1/2	2 7/8	AMC	226163	29	34 3/8	1 3/4	MACK TRUCKS
226038	35	39 3/8	2 7/8	OSHKOSH	226164	30 1/8	25 5/8	2 3/8	MACK TRUCKS
226039	34	35 5/8	2 7/8	WESTERN STAR	226165	24 1/4	25	2 3/8	NAVISTAR
226040	40	28 3/4	2 3/8	KENWORTH	226166	24 1/4	26 1/4	2 7/8	NAVISTAR
226041	36 1/4	34 3/8	2 3/8	PETERBILT	226167	29	34 3/8	2 7/8	MACK TRUCKS
226042	31	35 5/8	2 7/8	WESTERN STAR	226169	26 1/4	26 1/4	3 7/16	NAVISTAR
226043	32 3/4	42 1/2	2 7/8	GMC	226171	26 1/2	25 5/8	1 1/4	NAVISTAR
226100	40	28 3/4	2 7/8	KENWORTH	226172	26 1/2	25 5/8	1 3/4	NAVISTAR
226101	32 3/4	28 3/4	2 7/8	KENWORTH	226173	26 1/2	25 5/8	1 3/4	NAVISTAR
226102	30	32 1/2	2 7/8	AUTOCAR	226174	26 3/4	25 5/8	1 3/4	NAVISTAR
226103	28	26 1/4	2 7/8	BLUE BIRD BUS	226175	26 3/4	26 1/4	2 7/8	NAVISTAR
226104	29 5/16	40	1 3/4	MACK TRUCKS	226176	27	25 5/8	2 3/8	NAVISTAR
226106	37 7/8	27 1/2	1 3/4	FORD TRUCK	226177	28 1/2	25 5/8	2 3/8	NAVISTAR
226107	31 3/4	40 5/8	2 3/8	VOLVO	226178	29 3/8	26 1/4	2 7/8	NAVISTAR
226108	37 7/8	27 1/2	2 3/8	FORD TRUCK	226179	29 3/4	25 5/8	1 3/4	NAVISTAR
226110	43 1/4	33 1/8	2 3/8	FORD TRUCK	226180	27 3/4	40 5/8	2 3/8	AUTOCAR
226111	25 1/2	28 3/4	2 3/8	GMC	226181	30 1/4	29 3/8	3 7/16	NAVISTAR
226113	28 3/8	28 1/8	2 7/8	GMC	226184	31	25 5/8	1 3/4	NAVISTAR
226114	30	43 1/8	2 7/8	GMC	226185	31	25 5/8	2 3/8	NAVISTAR
226116	32 3/4	42 1/2	2 7/8	GMC	226190	33 5/8	26 1/4	2 7/8	NAVISTAR
226118	37 1/4	25 5/8	2 3/8	GMC	226191	33 5/8	26 1/4	2 7/8	NAVISTAR
226119	48 5/8	34 3/8	1 3/4	FORD TRUCK	226193	34	35 5/8	2 7/8	WESTERN STAR
226120	39 1/2	27 1/2	2 7/8	GMC	226195	38	29 3/8	2 7/8	NAVISTAR
226121	39 1/2	27 1/2	2 3/8	GMC	226196	38	29 3/8	3 7/16	NAVISTAR
226122	44	27 1/2	2 7/8	GMC	226197	39 15/16	29 3/8	2 7/8	NAVISTAR
226123	35 1/16	29 3/8	2 7/8	CRANE CARRIER	226198	41	29 3/8	2 3/8	NAVISTAR
226125	48 5/8	34 3/8	2 3/8	FORD TRUCK	226199	35	40	3 7/16	KENWORTH
226126	37	32 1/2	2 7/8	FREIGHTLINER	226200	35	41 1/4	3 7/16	KENWORTH

Vista-Pro Radiator Core Catalog

(Sort by Model)

Model #	Height	Width	Depth	Application	Model #	Height	Width	Depth	Application
226201	39 1/4	30	2 7/8	KENWORTH	226291	28	26 1/4	2 7/8	BLUE BIRD BUS
226203	40	33 3/4	3 7/16	KENWORTH	226295	28	26 1/4	3 7/16	BLUE BIRD BUS
226206	27	21 1/4	2 7/8	MACK TRUCKS	226296	30	26 1/4	2 7/8	BLUE BIRD BUS
226207	29	34 3/8	2 3/8	MACK TRUCKS	226297	39 1/4	39 3/8	3 7/16	BLUE BIRD BUS
226208	29	40 5/8	1 3/4	AUTOCAR	226300	26 1/4	28 1/8	3 7/16	BROCKWAY
226209	29	34 3/8	2 3/8	MACK TRUCKS	226302	28 1/2	23 3/4	2 3/8	BROCKWAY
226210	29	34 3/8	2 7/8	MACK TRUCKS	226304	32 1/4	28 1/8	3 7/16	BROCKWAY
226211	29	34 3/8	2 7/8	MACK TRUCKS	226310	37	30	2 7/8	MACK TRUCKS
226212	29	34 3/8	3 7/16	MACK TRUCKS	226316	32 1/4	31 1/4	2 7/8	ADVANCE MIXER
226216	35 5/8	27 1/2	2 3/8	MACK TRUCKS	226318	32 3/4	28 1/8	2 7/8	AMERICAN LaFRANCE
226217	35 5/8	27 1/2	2 7/8	MACK TRUCKS	226320	28	26 1/4	2 3/8	BLUE BIRD BUS
226219	29 5/16	40	2 7/8	MACK TRUCKS	226321	19 7/8	21 1/4	1 3/4	GMC
226224	37	27 1/2	2 7/8	MACK TRUCKS	226323	33 1/4	31 1/4	3 7/16	AMC
226225	37	27 1/2	3 7/16	MACK TRUCKS	226325	28 15/16	35	2 7/8	GILLIG BUS
226226	39	27 1/2	2 3/8	MACK TRUCKS	226327	35	40	2 7/8	ADVANCE MIXER
226228	39 5/8	38 1/8	1 3/4	MACK TRUCKS	226330	32 1/2	28 1/8	2 7/8	GMC
226229	39 5/8	38 1/8	2 3/8	MACK TRUCKS	226331	39 1/2	27 1/2	2 7/8	GMC
226230	39 5/8	38 1/8	3 7/16	MACK TRUCKS	226332	44	27 1/2	2 7/8	GMC
226231	42 1/2	27 1/2	1 3/4	MACK TRUCKS	226333	46	28 3/4	2 7/8	GMC
226232	42 1/2	27 1/2	2 3/8	MACK TRUCKS	226335	34 1/2	28 3/4	4 7/16	FREIGHTLINER
226234	42 1/2	27 1/2	2 7/8	MACK TRUCKS	226336	19 7/8	23 1/8	1 3/4	GMC
226235	60 5/8	58 3/4	3 7/16	FERMONT	226337	19 7/8	23 1/8	2 3/8	GMC
226236	42 1/2	27 1/2	3 7/16	MACK TRUCKS	226338	20 5/8	19 3/8	2 3/8	GMC
226237	42 7/8	38 1/8	3 7/16	MACK TRUCKS	226339	20 5/8	20	1 3/4	GMC
226238	43	27 1/2	3 7/16	MACK TRUCKS	226342	24	28 3/4	2 3/8	GMC
226239	43 1/4	30 5/8	2 3/8	MACK TRUCKS	226343	24 3/4	23 3/4	1 3/4	GMC
226240	43 1/4	30 5/8	2 7/8	MACK TRUCKS	226349	28 1/4	26 1/4	2 3/8	GMC
226241	44 9/16	30 5/8	2 3/8	MACK TRUCKS	226350	28 1/4	27 1/2	1 3/4	GMC
226246	35 1/8	29 3/8	2 7/8	AUTOCAR	226351	28 1/4	27 1/2	2 3/8	GMC
226247	41	29 3/8	2 7/8	NAVISTAR	226352	28 3/8	28 1/8	1 3/4	GMC
226248	44	27 1/2	2 7/8	GMC	226358	30	28 3/4	2 7/8	GMC
226249	38 5/8	34 3/8	2 3/8	MACK TRUCKS	226364	32 1/2	27 1/2	2 3/8	GMC
226250	38 5/8	34 3/8	1 3/4	MACK TRUCKS	226365	32 1/2	27 1/2	2 3/8	GMC
226251	38 5/8	34 3/8	2 7/8	MACK TRUCKS	226366	32 1/2	27 1/2	2 7/8	GMC
226253	42	35	3 7/16	PETERBILT	226369	32 1/2	27 1/2	2 7/8	GMC
226254	37 1/2	38 3/4	2 3/8	PETERBILT	226370	32 1/2	27 1/2	2 7/8	GMC
226255	37 1/2	38 3/4	2 7/8	PETERBILT	226377	33 1/4	31 7/8	2 7/8	GMC
226256	29	38 3/4	3 7/16	PETERBILT	226379	36 1/4	33 1/8	2 7/8	GMC
226257	29	38 3/4	2 7/8	PETERBILT	226380	36 1/4	33 1/8	3 15/16	GMC
226258	33	38 3/4	2 7/8	PETERBILT	226381	37 1/4	25 5/8	1 3/4	GMC
226260	28 1/8	28 3/4	3 7/16	GMC	226382	39 1/2	27 1/2	2 3/8	GMC
226261	37 1/2	28 1/8	2 7/8	PETERBILT	226383	39 1/2	27 1/2	2 7/8	GMC
226262	29 5/16	40	2 3/8	MACK TRUCKS	226386	44	26 7/8	2 7/8	GMC
226267	30	32 1/2	2 3/8	AUTOCAR	226388	44	27 1/2	2 7/8	GMC
226269	37	32 1/2	2 3/8	FREIGHTLINER	226389	44	27 1/2	2 7/8	GMC
226271	30	32 1/2	2 3/8	AUTOCAR	226390	44	27 1/2	2 7/8	GMC
226272	30	32 1/2	2 7/8	AUTOCAR	226391	44	27 1/2	2 7/8	GMC
226274	32 1/2	40	3 7/16	AUTOCAR	226392	44	27 1/2	3 7/16	GMC
226275	32 1/2	40	3 7/16	AUTOCAR	226393	44	27 1/2	3 7/16	GMC
226280	35 3/8	27 1/2	1 3/4	AUTOCAR	226395	44	28 1/8	2 7/8	GMC
226281	35 3/8	27 1/2	2 7/8	AUTOCAR	226396	44	31 7/8	2 7/8	GMC
226282	35 7/8	40	3 7/16	AUTOCAR	226400	26	26 1/4	2 7/8	CRANE CARRIER
226286	38	35	1 3/4	VOLVO	226406	35 1/16	29 3/8	3 7/16	CRANE CARRIER
226287	43 3/8	28 1/8	3 7/16	PIERCE FIRE TRUCK	226407	35 1/16	29 3/8	2 3/8	CRANE CARRIER
226290	28	26 1/4	2 7/8	BLUE BIRD BUS	226409	37 1/2	37 1/2	2 7/8	CRANE CARRIER

Vista-Pro Radiator Core Catalog

(Sort by Model)

Model #	Height	Width	Depth	Application	Model #	Height	Width	Depth	Application
226410	40 7/8	29 3/8	3 7/16	CRANE CARRIER	226521	48	27 1/2	2 7/8	INGERSOLL-RAND
226411	18 1/4	17 1/2	2 3/8	DAVID BROWN TRACTOR	226523	50	52 1/2	3 7/16	INGERSOLL-RAND
226418	32	26 1/4	2 7/8	DIAMOND REO	226524	60	65	2 3/8	INGERSOLL-RAND
226429	40 1/2	29 3/8	2 3/8	DIAMOND REO	226525	19 1/2	17 1/2	2 3/8	IVECO TRUCK
226433	21 5/8	25	1 3/4	DODGE	226529	28 1/2	13 3/4	2 3/8	JOY MANUFACTURING
226434	21 3/4	25	2 3/8	DODGE	226530	32	31 1/4	2 7/8	JOY MANUFACTURING
226435	21 3/4	25	2 3/8	DODGE	226532	46	46 1/4	2 7/8	JOY MANUFACTURING
226437	25 3/8	25 5/8	1 3/4	DODGE	226536	31 3/4	40	4 7/16	KENWORTH
226448	24 3/4	31 7/8	3 7/16	F.W.D.	226537	31 3/4	40	3 7/16	KENWORTH
226454	20 1/4	20 5/8	2 7/8	FORD POWER PRODUCTS	226539	31 3/4	41 1/4	3 7/16	KENWORTH
226455	18	26 1/4	2 3/8	FORD TRUCK	226543	35	40	4 7/16	KENWORTH
226456	18	26 1/4	1 3/4	FORD TRUCK	226544	35	40	3 7/16	KENWORTH
226457	20	23 3/4	1 3/4	FORD TRUCK	226545	35	41 1/4	2 3/8	KENWORTH
226458	20	23 3/4	2 3/8	FORD TRUCK	226546	35	40	2 3/8	KENWORTH
226465	24	26 1/4	2 3/8	FORD TRUCK	226547	35	40	2 7/8	KENWORTH
226466	48	46 1/4	2 7/8	CUMMINS ENGINE	226550	35 1/4	28 1/8	3 7/16	KENWORTH
226467	24	26 1/4	2 7/8	FORD TRUCK	226552	35 1/4	28 1/8	3 15/16	KENWORTH
226468	37	32 1/2	1 3/4	FREIGHTLINER	226553	39 1/4	30	3 7/16	KENWORTH
226469	37	32 1/2	2 3/8	FREIGHTLINER	226554	39 1/4	30	4 7/16	KENWORTH
226470	37	32 1/2	3 7/16	FREIGHTLINER	226555	39 1/4	30	2 3/8	KENWORTH
226471	37	32 1/2	3 7/16	FREIGHTLINER	226556	39 1/4	30	3 15/16	KENWORTH
226473	37	32 1/2	4 7/16	FREIGHTLINER	226557	40	30	3 7/16	KENWORTH
226474	24	26 1/4	3 7/16	FORD TRUCK	226558	40	33 3/4	2 3/8	KENWORTH
226475	24	26 1/4	3 7/16	FORD TRUCK	226559	40	33 3/4	4 7/16	KENWORTH
226477	24 5/16	26 1/4	1 3/4	FORD TRUCK	226560	16 3/4	19 3/8	2 7/8	KUBOTA TRACTOR
226478	24 5/16	26 1/4	1 3/4	FORD TRUCK	226562	18 5/8	17 1/2	1 3/4	LIFT TRUCKS & LOADERS
226479	24 1/4	26 1/4	2 3/8	FORD TRUCK	226565	25 1/4	21 7/8	2 7/8	MACK TRUCKS
226480	24 1/4	26 1/4	2 3/8	FORD TRUCK	226566	26 1/4	20 5/8	2 7/8	MACK TRUCKS
226481	24 5/16	26 1/4	2 3/8	FORD TRUCK	226567	26 3/4	20 5/8	2 3/8	MACK TRUCKS
226482	24 5/16	26 1/4	2 3/8	FORD TRUCK	226569	27	20 5/8	2 3/8	MACK TRUCKS
226483	38 9/16	26 7/8	2 3/8	VOLVO	226570	27	21 1/4	2 7/8	MACK TRUCKS
226484	24 5/16	26 1/4	2 3/8	FORD TRUCK	226571	27	20 5/8	2 3/8	MACK TRUCKS
226485	24 1/4	26 1/4	2 7/8	FORD TRUCK	226572	28 1/2	23 3/4	2 3/8	MACK TRUCKS
226486	24 5/16	26 1/4	2 7/8	FORD TRUCK	226573	35 5/8	35	2 7/8	VOLVO
226487	26 3/4	29 3/8	2 3/8	FORD TRUCK	226574	28 1/2	23 3/4	2 7/8	MACK TRUCKS
226488	27 1/2	26 1/4	2 3/8	FORD TRUCK	226575	28 7/8	23 3/4	2 3/8	MACK TRUCKS
226489	27 1/2	26 1/4	2 3/8	FORD TRUCK	226576	28 7/8	23 3/4	2 7/8	MACK TRUCKS
226490	27 1/2	26 1/4	2 7/8	FORD TRUCK	226579	29	34 3/8	2 3/8	MACK TRUCKS
226491	27 3/4	29 3/8	2 3/8	FORD TRUCK	226580	29	34 3/8	3 7/16	MACK TRUCKS
226492	28 1/4	27 1/2	2 3/8	FORD TRUCK	226581	29	34 3/8	3 7/16	MACK TRUCKS
226493	28 1/4	27 1/2	1 3/4	FORD TRUCK	226582	30 3/8	22 1/2	2 7/8	MACK TRUCKS
226494	28 3/4	26 1/4	2 3/8	FORD TRUCK	226584	30 3/8	34 3/8	2 3/8	MACK TRUCKS
226500	37 1/2	28 1/8	2 3/8	FORD TRUCK	226586	31 5/8	31 1/4	2 3/8	MACK TRUCKS
226501	34 1/2	28 1/8	2 7/8	FREIGHTLINER	226588	33 1/2	23 3/4	2 7/8	MACK TRUCKS
226503	34 1/2	28 1/8	3 15/16	FREIGHTLINER	226591	35 5/8	27 1/2	2 3/8	MACK TRUCKS
226504	37	32 1/2	1 3/4	FREIGHTLINER	226592	35 5/8	27 1/2	2 7/8	MACK TRUCKS
226505	37	32 1/2	3 15/16	FREIGHTLINER	226598	31 7/8	28 3/4	1 3/4	THOMAS BUS
226506	37	32 1/2	3 15/16	FREIGHTLINER	226600	37 3/16	38 1/8	2 3/8	MACK TRUCKS
226507	37 1/2	28 1/8	4 7/16	FREIGHTLINER	226601	37 3/16	38 1/8	2 7/8	MACK TRUCKS
226509	35 1/2	26 1/4	3 7/16	HAHN	226603	39 5/8	38 1/8	2 7/8	MACK TRUCKS
226514	26 1/8	22 1/2	1 1/4	INGERSOLL-RAND	226605	40 3/16	35	2 3/8	MACK TRUCKS
226516	39 3/8	38 3/4	2 3/8	INGERSOLL-RAND	226606	40 1/4	34 3/8	2 7/8	MACK TRUCKS
226518	42	52 1/2	3 7/16	INGERSOLL-RAND	226610	43 1/4	30 5/8	1 3/4	MACK TRUCKS
226519	44 1/2	25	3 7/16	INGERSOLL-RAND	226612	44	34 3/8	2 3/8	MACK TRUCKS
226520	46	47 1/2	2 3/8	INGERSOLL-RAND	226613	44	34 3/8	2 7/8	MACK TRUCKS

Vista-Pro Radiator Core Catalog

(Sort by Model)

Model #	Height	Width	Depth	Application	Model #	Height	Width	Depth	Application
226615	44 9/16	30 5/8	2 7/8	MACK TRUCKS	226722	20 1/4	8 3/4	3 7/16	TRUCK AND BUS HEATER
226620	39 7/8	30	3 7/16	MARMON TRUCK	226723	20 1/4	10 5/8	2 7/8	TRUCK AND BUS HEATER
226622	40	30	3 7/16	MARMON TRUCK	226724	20 3/4	10 5/8	3 7/16	TRUCK AND BUS HEATER
226625	26 1/2	25 5/8	2 3/8	MERCEDES-BENZ	226725	20 3/4	11 1/4	2 7/8	TRUCK AND BUS HEATER
226626	16 1/2	19 3/8	1 1/4	MILLER ELECTRIC	226726	22 1/2	10 5/8	2 7/8	TRUCK AND BUS HEATER
226629	24 1/4	25 5/8	2 7/8	NAVISTAR	226730	27 1/4	9 3/8	1 3/4	TRUCK AND BUS HEATER
226632	24 3/4	23 3/4	2 3/8	NAVISTAR	226732	25 1/2	22 1/2	2 7/8	VOLVO
226633	24 7/8	21 7/8	1 3/4	NAVISTAR	226733	27 5/8	26 7/8	2 7/8	VOLVO
226634	25	21 7/8	2 3/8	NAVISTAR	226736	29	40 5/8	2 7/8	VOLVO
226635	26 1/4	26 1/4	2 7/8	NAVISTAR	226743	33 1/2	26 7/8	1 3/4	VOLVO
226636	26 1/2	25 5/8	2 3/8	NAVISTAR	226744	35 3/8	35	1 3/4	VOLVO
226637	26 1/2	25 5/8	2 7/8	NAVISTAR	226745	35 3/8	35	2 7/8	VOLVO
226638	27	26 1/4	2 3/8	NAVISTAR	226746	35 3/8	35	2 3/8	VOLVO
226640	28 5/8	26 1/4	2 7/8	NAVISTAR	226750	35 1/2	40 5/8	2 7/8	VOLVO
226641	29 3/8	26 1/4	2 7/8	NAVISTAR	226751	38	27 1/2	2 7/8	VOLVO
226642	29 3/8	26 1/4	2 3/8	NAVISTAR	226753	38	27 1/2	1 3/4	VOLVO
226643	29 3/8	26 1/4	2 3/8	NAVISTAR	226754	38	27 1/2	2 3/8	VOLVO
226645	29 1/2	22 1/2	2 3/8	NAVISTAR	226755	38	27 1/2	3 7/16	VOLVO
226648	30 1/4	29 3/8	2 7/8	NAVISTAR	226758	38	29 3/8	2 7/8	VOLVO
226649	30 1/4	29 3/8	2 7/8	NAVISTAR	226759	38	29 3/8	3 7/16	VOLVO
226650	30 1/4	29 3/8	2 7/8	NAVISTAR	226760	38	35	1 3/4	VOLVO
226651	30 1/4	29 3/8	1 3/4	NAVISTAR	226761	38	35	2 3/8	VOLVO
226652	30 1/4	29 3/8	2 3/8	NAVISTAR	226762	38	35	2 7/8	VOLVO
226653	30 1/4	29 3/8	2 3/8	NAVISTAR	226763	38	35	3 7/16	VOLVO
226654	31 1/2	28 1/8	2 7/8	NAVISTAR	226765	38	35 5/8	2 3/8	VOLVO
226657	32 1/4	25 5/8	2 3/8	NAVISTAR	226766	38	37 1/2	1 3/4	VOLVO
226658	33 5/8	26 1/4	2 3/8	NAVISTAR	226767	38	37 1/2	2 7/8	VOLVO
226661	34	29 3/8	2 3/8	NAVISTAR	226768	38	37 1/2	2 3/8	VOLVO
226670	37 1/8	40	2 7/8	NAVISTAR	226770	38	40 5/8	2 7/8	VOLVO
226671	37 1/8	40	2 3/8	NAVISTAR	226771	38 3/8	29 3/8	2 7/8	VOLVO
226672	37 1/8	40	3 7/16	NAVISTAR	226772	43 3/8	35	2 7/8	VOLVO
226673	37 3/16	32 1/2	2 7/8	NAVISTAR	226774	43 3/8	35	3 7/16	VOLVO
226674	37 3/16	32 1/2	2 3/8	NAVISTAR	226779	35 1/4	25	2 7/8	WARD La FRANCE
226676	38	26 1/4	2 7/8	NAVISTAR	226780	31 5/8	29 3/8	1 3/4	WESTERN STAR
226678	38	29 3/8	3 7/16	NAVISTAR	226781	31 5/8	28 3/4	1 3/4	WESTERN STAR
226680	38	29 3/8	2 3/8	NAVISTAR	226782	31 5/8	29 3/8	2 3/8	WESTERN STAR
226681	38	29 3/8	2 7/8	NAVISTAR	226784	31 5/8	29 3/8	2 7/8	WESTERN STAR
226683	39 15/16	28 1/8	1 3/4	NAVISTAR	226786	32 1/2	35 5/8	2 7/8	WESTERN STAR
226684	39 15/16	28 1/8	2 7/8	NAVISTAR	226787	32 1/2	36 1/4	2 3/8	WESTERN STAR
226685	39 15/16	35 5/8	2 7/8	NAVISTAR	226788	32 1/2	36 1/4	2 7/8	WESTERN STAR
226687	41	29 3/8	3 7/16	NAVISTAR	226790	35 1/8	29 3/8	2 3/8	WESTERN STAR
226691	43 3/4	29 3/8	3 7/16	NAVISTAR	226792	39 1/8	36 7/8	2 7/8	WESTERN STAR
226693	44	29 3/8	3 7/16	NAVISTAR	226793	39 1/4	36 7/8	2 7/8	WESTERN STAR
226697	34 1/4	35	3 7/16	NEOPLAN BUS	226794	39 1/4	36 7/8	2 7/8	WESTERN STAR
226702	41 5/8	35	2 3/8	ONAN	226802	31	25 5/8	2 3/8	NAVISTAR
226704	32	26 1/4	3 7/16	OTTAWA TRUCK	226803	29 3/4	25 5/8	2 3/8	NAVISTAR
226705	30	28 1/8	3 7/16	PETERBILT	226804	24	25 5/8	2 3/8	FORD TRUCK
226706	37 1/2	28 1/8	3 7/16	PETERBILT	226805	24	25 5/8	2 7/8	FORD TRUCK
226707	37 1/2	28 1/8	4 7/16	PETERBILT	226809	37 1/2	28 1/8	1 3/4	FORD TRUCK
226709	37 1/2	38 1/8	4 7/16	PETERBILT	226810	35 1/4	29 3/8	3 7/16	CRANE CARRIER
226710	37 1/2	38 3/4	3 7/16	PETERBILT	226811	28 1/4	27 1/2	2 3/8	FORD TRUCK
226712	12	10 5/8	2 7/8	TRUCK AND BUS HEATER	226812	39	26 7/8	2 7/8	MACK TRUCKS
226713	19	51 1/4	3 7/16	CROWN COACH	226814	40	28 3/4	3 7/16	KENWORTH
226715	13 3/8	9 3/8	1 3/4	TRUCK AND BUS HEATER	226818	38 1/2	27 1/2	2 7/8	MACK TRUCKS
226718	17 1/4	8 3/4	2 3/8	TRUCK AND BUS HEATER	226819	31	25 5/8	2 3/8	NAVISTAR

Vista-Pro Radiator Core Catalog

(Sort by Model)

Model #	Height	Width	Depth	Application	Model #	Height	Width	Depth	Application
226820	24 5/16	26 1/4	2 7/8	FORD TRUCK	229027	17 11/16	23 3/4	2 3/8	JOHN DEERE
226822	25	35	2 3/8	OSHKOSH	229028	23 3/4	22 1/2	3 7/16	CASE/INTERNATIONAL
226831	29 1/8	27 1/2	2 3/8	FORD TRUCK	229029	22 5/8	18 3/4	3 7/16	INT'L HARVESTER
226832	33 5/8	26 1/4	2 7/8	NAVISTAR	229032	19 7/8	18 1/8	4 7/16	JOHN DEERE
226839	35 1/16	29 3/8	3 7/16	CRANE CARRIER	229034	18	21 7/8	2 7/8	CASE/INTERNATIONAL
226841	38 1/2	27 1/2	2 7/8	MACK TRUCKS	229036	17 3/4	14 3/8	3 7/16	JOHN DEERE
226842	27	26 1/4	2 3/8	NAVISTAR	229040	26 1/8	23 1/8	1 3/4	DAVEY COMPRESSOR
226843	30 5/8	24 3/8	2 7/8	OTTAWA TRUCK	229041	27 1/8	21 7/8	3 7/16	JOHN DEERE
226844	42 3/4	28 1/8	2 7/8	NAVISTAR	229042	22 1/2	27 1/2	2 7/8	DRESSER INDUSTRIES
226846	36 1/4	34 3/8	2 7/8	PETERBILT	229043	23 15/16	20 5/8	4 7/16	DRESSER INDUSTRIES
226847	31	25 5/8	1 3/4	NAVISTAR	229045	36	58 1/8	4 7/16	EUCLID
226848	45	46 7/8	2 7/8	DETROIT DIESEL	229046	19 3/4	19 3/8	2 7/8	FORD POWER PRODUCTS
226849	31 1/16	11 7/8	2 3/8	INTERNATIONAL	229047	17 5/16	15 5/8	2 3/8	FORD TRACTOR
226851	42 3/4	28 1/8	2 7/8	NAVISTAR	229048	17 3/4	18 1/8	2 7/8	FORD TRACTOR
226853	31 7/8	31 7/8	3 7/16	CUMMINS/DETROIT	229049	20 1/4	25 5/8	2 3/8	FORD TRACTOR
226854	36 1/4	36 1/4	3 7/16	CUMMINS/DETROIT	229050	20 3/4	18 1/8	2 7/8	FORD TRACTOR
226855	42 1/2	42 1/2	3 7/16	CUMMINS/DETROIT	229051	20 3/4	18 1/8	3 7/16	FORD TRACTOR
226856	48 1/8	48 1/8	3 7/16	CUMMINS/DETROIT	229052	24	25	2 7/8	FORD TRACTOR
226857	33 1/4	31 7/8	3 7/16	CUMMINS/DETROIT	229053	26 9/16	25 5/8	3 7/16	FORD TRACTOR
226858	38 1/4	36 1/4	3 7/16	CUMMINS/DETROIT	229054	26 9/16	25 5/8	3 15/16	FORD TRACTOR
226861	31	25 5/8	2 3/8	NAVISTAR	229059	35 1/2	31 1/4	3 15/16	FORD TRACTOR
226862	29 3/4	25 5/8	2 3/8	NAVISTAR	229060	36	33 1/8	3 7/16	FORD TRACTOR
226866	39	15 5/8	4 7/16	FLXIBLE BUS	229063	22 1/2	23 1/8	2 3/8	GALION
226867	30 1/8	16 7/8	4 7/16	VOSS BUS	229066	29 3/8	27 1/2	3 7/16	GALION
226869	31 3/4	38 3/4	3 15/16	GILLIG BUS	229067	32 1/2	27 1/2	2 7/8	GALION
226886	29	27 1/2	3 7/16	ORION BUS	229068	32 1/2	27 1/2	3 7/16	GALION
226887	19 1/4	26 1/4	1 3/4	FORD	229069	22 7/8	27 1/2	2 7/8	GARDNER DENVER
226889	30 1/4	29 3/8	1 3/4	NAVISTAR	229070	23 1/8	23 1/8	2 3/8	GARDNER DENVER
226890	32 3/16	25 5/8	2 7/8	NAVISTAR	229072	25 7/8	13 3/4	2 3/8	GARDNER DENVER
226891	32 3/4	28 3/4	2 3/8	KENWORTH	229076	41 1/8	21 1/4	2 7/8	GARDNER DENVER
226893	39 15/16	28 1/8	2 3/8	INTERNATIONAL	229077	34	25	3 15/16	HERCULES ENGINE
226894	41 1/4	46 1/4	3 7/16	BLUE BIRD BUS	229080	20 5/8	21 1/4	1 3/4	INGERSOLL-RAND
226896	39 3/4	29 3/8	3 7/16	OSHKOSH	229081	23 1/8	23 1/8	1 3/4	INGERSOLL-RAND
229001	15 1/2	14 3/8	2 7/8	JOHN DEERE	229082	25 3/4	25 5/8	2 3/8	INGERSOLL-RAND
229005	29 1/2	22 1/2	2 7/8	AERO	229083	25 3/4	25 5/8	2 7/8	INGERSOLL-RAND
229006	17 3/4	14 3/8	2 3/8	JOHN DEERE	229088	13 3/4	11 7/8	2 3/8	INT'L HARVESTER
229007	20 1/8	22 1/2	2 7/8	LIFT TRUCKS & LOADERS	229089	15	13 3/4	2 3/8	INT'L HARVESTER
229008	18 3/4	18 1/8	1 3/4	LIFT TRUCKS & LOADERS	229090	16 1/4	16 1/4	2 3/8	INT'L HARVESTER
229009	30 1/8	26 1/4	3 15/16	JOHN DEERE	229091	16 11/16	18 1/8	2 3/8	INT'L HARVESTER
229010	17 3/4	17 1/2	2 3/8	CASE/INTERNATIONAL	229092	20 3/8	15 5/8	2 7/8	INT'L HARVESTER
229011	17 3/4	16 7/8	2 3/8	FORD TRACTOR	229093	20 3/8	19 3/8	2 7/8	INT'L HARVESTER
229012	18 1/4	18 1/8	2 7/8	FORD TRACTOR	229094	20 3/8	19 3/8	3 7/16	INT'L HARVESTER
229013	18 3/8	18 3/4	2 3/8	INT'L HARVESTER	229095	36 1/8	30	3 7/16	FORD TRACTOR
229014	24	22 1/2	3 7/16	INT'L HARVESTER	229096	22 11/16	25	2 3/8	INT'L HARVESTER
229015	24	22 1/2	3 15/16	INT'L HARVESTER	229097	22 11/16	25	2 7/8	INT'L HARVESTER
229016	17	14 3/8	1 3/4	JOHN DEERE	229098	22 11/16	25	3 7/16	INT'L HARVESTER
229018	20 1/8	16 1/4	4 7/16	JOHN DEERE	229100	23 1/4	19 3/8	3 7/16	INT'L HARVESTER
229019	24 3/8	19 3/8	2 7/8	JOHN DEERE	229101	24	22 1/2	2 3/8	INT'L HARVESTER
229020	26 3/4	21 7/8	3 7/16	JOHN DEERE	229102	24	22 1/2	2 7/8	INT'L HARVESTER
229021	27	21 1/4	3 7/16	JOHN DEERE	229103	27 1/8	25	3 7/16	INT'L HARVESTER
229022	28 5/8	21 7/8	3 7/16	JOHN DEERE	229104	27 1/8	25	3 15/16	INT'L HARVESTER
229023	29	21 7/8	3 7/16	JOHN DEERE	229105	27 15/16	25	3 7/16	INT'L HARVESTER
229024	30 1/8	26 1/4	3 7/16	JOHN DEERE	229107	30 1/2	26 1/4	2 3/8	INT'L HARVESTER
229025	34 1/4	27 1/2	3 15/16	JOHN DEERE	229108	30 1/2	26 1/4	2 7/8	INT'L HARVESTER
229026	19 1/4	18 1/8	2 7/8	LIFT TRUCKS & LOADERS	229109	30 1/2	26 1/4	3 7/16	INT'L HARVESTER

Vista-Pro Radiator Core Catalog

(Sort by Model)

Model #	Height	Width	Depth	Application	Model #	Height	Width	Depth	Application
229110	30 1/2	26 1/4	3 15/16	INT'L HARVESTER	229180	24 5/8	26 1/4	2 3/8	FIAT ALLIS
229110	30 1/2	26 1/4	3 15/16	INT'L HARVESTER	229181	16 1/4	16 7/8	2 7/8	FIAT ALLIS
229110	30 1/2	26 1/4	3 15/16	INT'L HARVESTER	229182	28 7/8	26 1/4	3 15/16	FIAT ALLIS
229111	32 3/4	25	4 7/16	INT'L HARVESTER	229183	19 3/8	18 3/4	2 3/8	FIAT ALLIS
229116	27 13/16	25	2 7/8	INT'L HARVESTER	229188	20 1/2	25	2 7/8	FIAT ALLIS
229120	14	13 3/4	2 3/8	KOHLER ENGINES & GEN	229189	20 1/2	25	3 7/16	FIAT ALLIS
229122	23	23 1/8	1 3/4	KOHLER ENGINES & GEN	229190	22 1/4	26 7/8	2 7/8	FIAT ALLIS
229123	27 1/2	25	2 7/8	KOHLER ENGINES & GEN	229191	23 1/4	21 1/4	1 3/4	FIAT ALLIS
229124	28	27 1/2	2 7/8	KOHLER ENGINES & GEN	229192	25 7/8	26 1/4	3 7/16	FIAT ALLIS
229125	29 9/16	27 1/2	3 15/16	KOHLER ENGINES & GEN	229200	38	37 1/2	3 15/16	CATERPILLAR
229126	30 1/4	30 5/8	3 15/16	KOHLER ENGINES & GEN	229201	15 3/4	16 7/8	2 7/8	LIFT TRUCKS & LOADERS
229127	22 1/2	23 1/8	2 7/8	GALION	229202	41 1/2	26 7/8	3 15/16	JOHN DEERE
229128	22 7/8	25	2 7/8	DRESSER INDUSTRIES	229203	32 1/2	30 5/8	3 7/16	CASE/INTERNATIONAL
229129	29 1/4	27 1/2	2 7/8	DRESSER INDUSTRIES	229204	24 3/4	21 7/8	3 7/16	FORD TRACTOR
229130	15 3/4	17 1/2	4 7/16	LIFT TRUCKS & LOADERS	229205	30	16 7/8	3 7/16	NOVA BUS
229131	15 7/8	17 1/2	2 7/8	LIFT TRUCKS & LOADERS	229206	30 1/2	36 7/8	3 15/16	FLXIBLE BUS
229132	26 3/8	25	2 7/8	FORD TRACTOR	229207	36 1/4	33 1/8	4 7/16	GMC
229135	25	25	2 3/8	BLAW KNOX	229500	15 3/8	19	3	LIFT TRUCKS & LOADERS
229136	26 1/4	13 3/4	2 3/8	ATLAS COPCO	229501	19 1/4	23 1/2	3	CASE/INTERNATIONAL
229137	48	48 1/8	3 15/16	OSHKOSH	229502	28 1/4	29	3	CATERPILLAR
229138	25	25	3 7/16	BLAW KNOX	229503	29 1/4	16 1/2	4 1/2	CATERPILLAR
229143	30 1/8	17 1/2	4.4375	MISC	229504	33 7/16	33 1/2	3	CATERPILLAR
229144	19 1/16	23 1/8	2 7/8	CASE/INTERNATIONAL	229505	34 3/4	31 1/2	4 1/2	CATERPILLAR
229145	19 1/16	23 1/8	3 7/16	CASE/INTERNATIONAL	229506	35 3/4	23	5 1/4	CATERPILLAR
229146	19 1/16	23 1/8	3 15/16	CASE/INTERNATIONAL	229507	38	31 1/2	3 3/4	CATERPILLAR
229147	19	23 3/4	2 7/8	CASE/INTERNATIONAL	229508	38	38	4 1/2	CATERPILLAR
229148	26 5/8	27 1/2	2 7/8	CASE/INTERNATIONAL	229509	45 1/2	45	6	CATERPILLAR
229149	19 1/4	20	2 7/8	CASE/INTERNATIONAL	229511	54 1/8	51	5 1/4	CATERPILLAR
229151	19 1/4	20	3 7/16	CASE/INTERNATIONAL	229513	23	23 1/2	3 3/4	FIAT ALLIS
229152	19 1/4	20 5/8	2 3/8	CASE/INTERNATIONAL	229514	20 3/8	19 1/2	3	FORD POWER PRODUCTS
229153	31 1/8	27 1/2	2 7/8	CASE/INTERNATIONAL	229515	30 1/4	26 1/2	3	FORD TRUCK
229154	19 1/4	20 5/8	3 15/16	CASE/INTERNATIONAL	229516	24 3/8	19 1/2	3	JOHN DEERE
229155	19 3/8	19 3/8	2 3/8	CASE/INTERNATIONAL	229517	28	27	3 3/4	JOHN DEERE
229156	19 1/2	25	2 7/8	CASE/INTERNATIONAL	229518	15 3/4	17	3	LIFT TRUCKS & LOADERS
229157	21 3/4	26 7/8	2 7/8	CASE/INTERNATIONAL	229519	30 1/4	11 1/2	3 3/4	LIFT TRUCKS & LOADERS
229158	23 13/16	22 1/2	2 7/8	CASE/INTERNATIONAL	229522	26 3/4	26 1/2	3	CATERPILLAR
229159	23 13/16	22 1/2	3 7/16	CASE/INTERNATIONAL	229524	26 5/8	27 1/2	3 3/4	CASE/INTERNATIONAL
229160	26 1/4	27 1/2	2 3/8	CASE/INTERNATIONAL	229525	21 3/4	21 1/2	4 1/2	CATERPILLAR
229161	26 1/4	27 1/2	2 7/8	CASE/INTERNATIONAL	229527	19 5/8	17	3	LIFT TRUCKS & LOADERS
229162	26 1/4	27 1/2	3 7/16	CASE/INTERNATIONAL	229532	27 3/4	26	3 3/4	CATERPILLAR
229163	26 1/4	27 1/2	3 15/16	CASE/INTERNATIONAL	229537	34 3/4	26 1/2	4 1/2	CATERPILLAR
229164	21	22 1/2	2 7/8	CASE/INTERNATIONAL	229539	37 3/4	28	4 1/2	CATERPILLAR
229165	26 1/8	30	3 15/16	CASE/INTERNATIONAL	229542	38	32	4 1/2	CATERPILLAR
229166	26 5/8	27 1/2	3 7/16	CASE/INTERNATIONAL	229544	40 7/16	31	6	CATERPILLAR
229167	26 5/8	30	3 15/16	CASE/INTERNATIONAL	229545	43 1/2	39 1/2	4 1/2	CATERPILLAR
229168	27	27 1/2	3 7/16	CASE/INTERNATIONAL	229547	48 1/4	47 1/2	6	CATERPILLAR
229169	21 1/16	23 1/8	2 7/8	CASE/INTERNATIONAL	229548	51 1/4	46 1/2	6	CATERPILLAR
229170	31 1/8	27 1/2	3 7/16	CASE/INTERNATIONAL	229550	37 3/16	32	5 1/4	DRESSER INDUSTRIES
229171	31 3/4	30 5/8	3 15/16	CASE/INTERNATIONAL	229551	23	25	3 3/4	FIAT ALLIS
229174	20 5/8	21 1/4	2 7/8	CATERPILLAR	229554	51	52 1/2	4 1/2	FIAT ALLIS
229175	22 1/4	24 3/8	2 7/8	CATERPILLAR	229557	50 3/8	47 1/2	5 1/4	KOMATSU
229176	29	26 1/4	3 7/16	JOHN DEERE	229559	30	35 1/2	4 1/2	CATERPILLAR
229177	29 1/8	25 5/8	3 7/16	JOHN DEERE	229560	30 1/2	26 1/2	4 1/2	CATERPILLAR
229178	24 5/8	26 1/4	2 7/8	FIAT ALLIS	229561	47 1/2	43 1/2	5 1/4	CATERPILLAR
229179	24 5/8	26 1/4	3 7/16	FIAT ALLIS	229563	32	35 1/2	4 1/2	CATERPILLAR

Vista-Pro Radiator Core Catalog

(Sort by Model)

Model #	Height	Width	Depth	Application	Model #	Height	Width	Depth	Application
229564	40 3/8	25 1/2	6	CATERPILLAR	229654	16 5/8	17	3	LIFT TRUCKS & LOADERS
229565	48 1/4	47 1/2	6	CATERPILLAR	229655	38	27 1/2	3 3/4	VOLVO
229566	48 5/16	47 1/2	5 1/4	CATERPILLAR	229656	19 5/8	17	3	LIFT TRUCKS & LOADERS
229568	42 13/16	40	4 1/2	CATERPILLAR	229657	38	27 1/2	3 3/4	VOLVO
229569	52	51	6	CATERPILLAR	229658	38	27 1/2	3 3/4	VOLVO
229570	28 1/4	24	3	GMC	229659	21 1/16	21	3	CATERPILLAR
229571	24	25	3	FORD TRACTOR	229667	17 3/4	17	3	LIFT TRUCKS & LOADERS
229572	24 5/16	26 1/2	3	FORD TRUCK	229668	15 3/4	17	3	LIFT TRUCKS & LOADERS
229573	34	40	6	EUCLID	251000	32 3/4	28 1/2	2 1/4	KENWORTH
229574	47 1/4	44	5 1/4	KOMATSU	251001	25	35	3	OSHKOSH
229579	32 3/8	33	4 1/2	KOMATSU	251002	40	28 1/2	2 1/4	KENWORTH
229581	20 7/8	21	3	CATERPILLAR	251003	30 3/8	34 1/2	2 1/4	MACK TRUCKS
229582	54 1/8	51	6	CATERPILLAR	251005	31	35	3	WESTERN STAR
229584	21 3/4	21 1/2	4 1/2	CATERPILLAR	251006	37	32 1/2	2 1/4	FREIGHTLINER
229585	26	27 1/2	3 3/4	CATERPILLAR	251007	42 3/4	28	3	NAVISTAR
229586	26 3/4	24	3 3/4	CATERPILLAR	251008	31 3/4	40 1/2	2 1/4	VOLVO
229587	26 3/4	26 1/2	3	CATERPILLAR	251009	37	32 1/2	3	FREIGHTLINER
229588	27 3/4	26	3 3/4	CATERPILLAR	251010	40	28 1/2	3	KENWORTH
229589	28 1/4	26	3 3/4	CATERPILLAR	251011	43 1/4	33	2 1/4	FORD TRUCK
229590	28 1/4	29	3	CATERPILLAR	251014	32 3/16	25 1/2	3	NAVISTAR
229591	30	35 1/2	4 1/2	CATERPILLAR	251015	32 3/4	28 1/2	3	KENWORTH
229592	58 5/8	57 1/2	6	CATERPILLAR	251016	29 1/4	34 1/2	3	PETERBILT
229593	30 1/2	26 1/2	4 1/2	CATERPILLAR	251017	29	40 1/2	2 1/4	VOLVO
229594	31 11/16	28	3 3/4	CATERPILLAR	251018	32 1/2	35 1/2	3	WESTERN STAR
229595	32	35 1/2	4 1/2	CATERPILLAR	251019	38 5/8	34 1/2	3	MACK TRUCKS
229596	33 3/4	27 1/2	3 3/4	CATERPILLAR	251020	37 1/2	38	3	PETERBILT
229597	34 9/16	34 1/2	3 3/4	CATERPILLAR	251021	39 15/16	28	3	NAVISTAR
229598	34 3/4	31 1/2	3	CATERPILLAR	251022	32 3/4	42 1/2	2 1/4	GMC
229599	34 3/4	26 1/2	4 1/2	CATERPILLAR	251023	32 3/4	42 1/2	3	GMC
229600	28	27 1/2	3 3/4	CATERPILLAR	251024	39 3/4	30	3	NAVISTAR
229610	40 3/8	25 1/2	6	CATERPILLAR	251025	44	34 1/2	3	MACK TRUCKS
229611	40 7/16	31	6	CATERPILLAR	251028	39 15/16	35 1/2	3	NAVISTAR
229612	42 13/16	40	4 1/2	CATERPILLAR	251029	38	35	2 1/4	VOLVO
229614	43 1/2	39 1/2	4 1/2	CATERPILLAR	251030	44	27 1/2	3	GMC
229615	45 1/2	45	6	CATERPILLAR	251031	37 7/8	27 1/2	3	FORD TRUCK
229616	45 1/2	45	6	CATERPILLAR	251032	38	35	3	VOLVO
229617	45 1/2	42 1/2	4 1/2	CATERPILLAR	251033	36 1/4	34 1/2	3	PETERBILT
229618	45 1/2	42 1/2	4 1/2	CATERPILLAR	251034	37 7/8	27 1/2	2 1/4	FORD TRUCK
229619	45 1/2	42 1/2	4 1/2	CATERPILLAR	251035	39 3/4	30	2 1/4	NAVISTAR
229620	46	45 1/2	5 1/4	CATERPILLAR	251036	39 15/16	28	2 1/4	NAVISTAR
229621	47 1/2	43 1/2	5 1/4	CATERPILLAR	251037	42 3/4	28	2 1/4	NAVISTAR
229622	48 1/4	47 1/2	6	CATERPILLAR	251039	34	35	3	WESTERN STAR
229623	48 1/4	47 1/2	6	CATERPILLAR	251040	40	28 1/2	2 1/4	KENWORTH
229624	51 1/4	46 1/2	6	CATERPILLAR	251041	36 1/4	34 1/2	2 1/4	PETERBILT
229626	52	51	4 1/2	CATERPILLAR	251100	44	27 1/2	3	GMC
229628	54 1/8	51	5 1/4	CATERPILLAR	251101	37 7/8	27 1/2	1 1/2	FORD TRUCK
229629	54 1/8	51	6	CATERPILLAR	251102	37	32	2 1/4	FREIGHTLINER
229630	58 5/8	57 1/2	6	CATERPILLAR	251103	40	28 1/2	3	KENWORTH
229649	37 9/16	43	4 1/2	CATERPILLAR	251104	37	32	3	FREIGHTLINER
229650	19 5/8	17	2 1/4	LIFT TRUCKS & LOADERS	251105	37 7/8	27 1/2	3	FORD TRUCK
229651	17 5/8	17	3	LIFT TRUCKS & LOADERS	251106	29 5/16	40	1 1/2	MACK TRUCKS
229652	38	27 1/2	3 3/4	VOLVO	251107	37 7/8	27 1/2	2 1/4	FORD TRUCK
229652	38	27 1/2	3 3/4	VOLVO	251108	37 1/4	31	2 1/4	MACK TRUCKS
229652	38	27 1/2	3 3/4	VOLVO	251109	37 3/16	32 1/2	3	NAVISTAR
229653	15 5/8	17	3	LIFT TRUCKS & LOADERS	251110	29	34 1/2	2 1/4	MACK TRUCKS

Vista-Pro Radiator Core Catalog

(Sort by Model)

Model #	Height	Width	Depth	Application	Model #	Height	Width	Depth	Application
251112	39 3/4	30	2 1/4	NAVISTAR	252112	39 3/4	29 7/8	2 1/4	NAVISTAR
251113	39 15/16	28	3	NAVISTAR	253116	39 3/4	29 7/8	2 1/4	NAVISTAR
251114	39 3/4	30	1 1/2	NAVISTAR	252116	39 3/4	29 7/8	3	NAVISTAR
251115	38 5/8	34 1/2	2 1/4	MACK TRUCKS	252117	41	29 1/2	3	PETERBILT
251116	39 3/4	30	3	NAVISTAR	252118	36 1/4	34 1/8	2 1/4	PETERBILT
251117	41	29 1/2	3	NAVISTAR	252118	36 1/4	34 1/8	2 1/4	PETERBILT
251118	36 1/4	34 1/4	2 1/4	PETERBILT	252119	36 1/4	34 9/16	2.25	PETERBILT
251118	36 1/4	34 1/4	2 1/4	PETERBILT	252121	42 3/4	28 3/16	2 1/4	NAVISTAR
251119	32 1/2	35	2 1/4	WESTERN STAR	252122	31 3/4	40 7/16	2 1/4	VOLVO
251120	39 15/16	28	2 1/4	NAVISTAR	252123	36 1/4	34 1/2	3	PETERBILT
251121	42 3/4	28	2 1/4	NAVISTAR	252125	37 1/2	38 5/16	3	PETERBILT
251122	31 3/4	40 1/2	2 1/4	VOLVO	252126	29 5/16	40	2 1/4	MACK TRUCKS
251123	36 1/4	34 1/2	3	PETERBILT	252128	29	34 1/2	3	MACK TRUCKS
251124	42 3/4	28	3	NAVISTAR	252129	34	34 15/16	3	WESTERN STAR
251125	37 1/2	38 1/2	3	PETERBILT	252132	29 1/2	22 5/16	2 1/4	NAVISTAR
251126	29 5/16	40	2 1/4	MACK TRUCKS	252136	30 3/8	34 1/2	3	MACK TRUCKS
251128	29	34 1/2	3	MACK TRUCKS	252141	29	34 1/2	2 1/4	MACK TRUCKS
251129	34	35	3	WESTERN STAR	252141	29	34 1/2	2 1/4	MACK TRUCKS
251130	29 5/16	40	3	MACK TRUCKS	253000	32 3/4	28 5/8	1 1/2	KENWORTH
251132	29 1/2	22 1/2	2 1/4	NAVISTAR	253002	40	28 5/8	1 1/2	KENWORTH
251133	32 3/16	25 1/2	3	NAVISTAR	253003	30 3/8	34 1/2	1 1/2	MACK TRUCKS
251136	30 3/8	34 1/2	3	MACK TRUCKS	253006	37	32 7/16	1 1/2	FREIGHTLINER
251137	35	41	2 1/4	KENWORTH	253007	42 3/4	28 3/16	2 1/4	NAVISTAR
251138	35	41	3	KENWORTH	253008	31 3/4	40 7/16	1 1/2	VOLVO
251139	25	27 1/2	3	VOLVO	253015	32 3/4	28 5/8	2 1/4	KENWORTH
251141	29	34 1/2	2 1/4	MACK TRUCKS	253021	39 15/16	28 3/16	2 1/4	NAVISTAR
251218	36 1/4	34 1/4	2.25	PETERBILT	253028	39 15/16	35 3/8	2 1/4	NAVISTAR
252000	32 3/4	28 5/8	2 1/4	KENWORTH	253035	39 3/4	29 7/8	1 1/2	NAVISTAR
252002	40	28 5/8	2 1/4	KENWORTH	253041	36 1/4	34 1/2	1 1/2	PETERBILT
253103	40	28 5/8	2 1/4	KENWORTH	253102	37	32	1 1/2	FREIGHTLINER
252003	30 3/8	34 1/2	2 1/4	MACK TRUCKS	253107	37 7/8	27 3/8	1 1/2	FORD TRUCK
253136	30 3/8	34 1/2	2 1/4	MACK TRUCKS	253108	37 1/4	31 1/8	1 1/2	MACK TRUCKS
252006	37	32 7/16	2 1/4	FREIGHTLINER	253110	29	34 1/2	1 1/2	MACK TRUCKS
253009	37	32 7/16	2 1/4	FREIGHTLINER	253112	39 3/4	29 7/8	1 1/2	NAVISTAR
252007	42 3/4	28 3/16	3	NAVISTAR	253118	36 1/4	34 1/8	1 1/2	PETERBILT
252008	31 3/4	40 7/16	2.25	VOLVO	253118	36 1/4	34 1/8	1 1/2	PETERBILT
252009	37	32 7/16	3	FREIGHTLINER	253121	42 3/4	28 3/16	1 1/2	NAVISTAR
252015	32 3/4	28 5/8	3	KENWORTH	253122	31 3/4	40 7/16	1 1/2	VOLVO
252024	39 3/4	29 7/8	3	NAVISTAR	253123	36 1/4	34 1/2	2 1/4	PETERBILT
252028	39 15/16	35 3/8	3	NAVISTAR	253125	37 1/2	38 5/16	2 1/4	PETERBILT
252029	38	34 15/16	2 1/4	VOLVO	253126	29 5/16	40	1 1/2	MACK TRUCKS
252033	36 1/4	34 1/2	3	PETERBILT	253129	34	34 15/16	2 1/4	WESTERN STAR
252034	37 7/8	26 15/16	2 1/4	FORD TRUCK	253141	29	34 1/2	1 1/2	MACK TRUCKS
252035	39 3/4	29 7/8	2 1/4	NAVISTAR	254033	31 5/16	12 1/4	2.25	NAVISTAR
252035	39 3/4	29 7/8	2 1/4	NAVISTAR	260111	17 1/2	18 3/4	2 1/4	JOHN DEERE
252040	40	28 5/8	2 1/4	KENWORTH	260117	21	21 15/16	2 1/4	FIAT ALLIS
252041	36 1/4	34 1/2	2 1/4	PETERBILT	260118	13 1/4	15 3/16	2 1/4	FIAT ALLIS
252041	36 1/4	34 1/2	2 1/4	PETERBILT	260119	20	18	2 1/4	LIFT TRUCKS & LOADERS
252102	37	32	2 1/4	FREIGHTLINER	260137	23 3/4	20 1/4	3 3/4	CLETRAC
253104	37	32	2 1/4	FREIGHTLINER	260204	17 7/8	18 3/4	2 1/4	MINNEAPOLIS MOLINE
252103	40	28 5/8	3	KENWORTH	260208	27 5/16	10 5/8	3	GARDNER DENVER
252104	37	32	3	FREIGHTLINER	260212	23 15/16	21 1/4	2 1/4	OLIVER HART PARR
252107	37 7/8	27 3/8	2 1/4	FORD TRUCK	260251	22 5/8	18 9/16	2 1/4	INT'L HARVESTER
252108	37 1/4	31 1/8	2 1/4	MACK TRUCKS	260260	20 1/4	19 1/8	2 1/4	LeROI
252110	29	34 1/2	2 1/4	MACK TRUCKS	260281	17 1/2	25 5/16	2 1/4	STUDEBAKER

Vista-Pro Radiator Core Catalog

(Sort by Model)

Model #	Height	Width	Depth	Application	Model #	Height	Width	Depth	Application
260298	18	22 1/2	3	WHITE TRACTOR	261386	13 1/4	20 1/4	3	JEEP
260340	16 1/4	18 1/8	2 1/4	FIAT ALLIS	261403	17	18 9/16	3	LIFT TRUCKS & LOADERS
260348	22 3/4	16 7/8	3	FORD	261467	23	20 1/4	2 1/4	FIAT ALLIS
260355	30	29 1/4	3 3/4	GMC	261475	18 1/2	15 3/4	2 1/4	JOHN DEERE
260358	18 3/8	19 3/8	2 1/4	FIAT ALLIS	261493	20 1/4	20 1/4	3	CHRYSLER
260362	19 3/8	18 1/8	3 3/4	FIAT ALLIS	261516	28 9/16	28 11/16	4 1/2	GALION
260363	19 3/8	18 3/4	2 1/4	FIAT ALLIS	261521	15	16 5/16	3	LIFT TRUCKS & LOADERS
260379	18	19 11/16	2 1/4	LIFT TRUCKS & LOADERS	261523	15	16 7/8	3	LIFT TRUCKS & LOADERS
260381	18	22 1/2	2 1/4	INTERNATIONAL	261527	15 1/2	19 11/16	3	LIFT TRUCKS & LOADERS
260397	27 3/8	24 3/8	5 1/4	FIAT ALLIS	261538	16 1/8	16 5/16	3	LIFT TRUCKS & LOADERS
260524	16 7/8	12 3/8	3	TRIUMPH	261541	16 1/4	16 7/8	3	LIFT TRUCKS & LOADERS
260531	16 1/2	16 7/8	2 1/4	JEEP	261592	13 7/8	13 1/2	2 1/4	MASSEY-FERGUSON
260548	19 3/8	14 3/8	2 1/4	CASE/INTERNATIONAL	261598	16 3/4	19 1/8	3	MASSEY-FERGUSON
260551	19 1/2	15 5/8	2 1/4	CASE/INTERNATIONAL	261606	17 3/4	19 1/8	3	LIFT TRUCKS & LOADERS
260562	38	27 1/2	3 3/4	VOLVO	261615	17 7/8	23 1/16	3	LIFT TRUCKS & LOADERS
260595	20 1/4	20 1/4	3	CLETRAC	261629	19 1/8	20 13/16	3	FORD
260601	19 1/2	19 11/16	3	FORD	261634	18 3/4	19 1/8	2 1/4	LIFT TRUCKS & LOADERS
260633	22 5/16	21 15/16	2 1/4	MINNEAPOLIS MOLINE	261636	18 1/8	19 1/8	2 1/4	FIAT ALLIS
260644	19	19 11/16	2 1/4	GMC	261669	10 1/8	21 1/4	1 7/8	MORRIS
260661	18 1/4	20 1/4	3	CHRYSLER	261710	28	26 7/16	2 1/4	MINNEAPOLIS MOLINE
260690	23	19 1/8	3	MASSEY-FERGUSON	261712	20 3/4	20 1/4	3	LIFT TRUCKS & LOADERS
260710	20 1/4	18 9/16	2 1/4	CHRYSLER	261724	21	19 1/8	3	LIFT TRUCKS & LOADERS
260712	19 1/8	19 1/8	2 1/4	KOHLER ENGINES & GEN	261731	21 3/8	19 11/16	2 1/4	MINNEAPOLIS MOLINE
260713	20 5/16	22 1/2	2 1/4	FORD	261746	24	22 1/2	3 3/4	DRESSER INDUSTRIES
260720	30	26 7/16	4 1/2	CATERPILLAR	261762	22 1/2	23 5/8	3	LIFT TRUCKS & LOADERS
260754	18 3/4	13 3/4	3	JOHN DEERE	261784	10 5/16	18	2 1/4	MG
260761	21 1/2	13 3/4	3	JOHN DEERE	261840	24 7/8	24 3/4	3 3/4	LIFT TRUCKS & LOADERS
260764	16	22 1/2	3	LIFT TRUCKS & LOADERS	261857	25 3/4	22 1/2	3 3/4	LIFT TRUCKS & LOADERS
260770	22 1/2	25	3	JOHN DEERE	261925	21 5/8	20 13/16	2 1/4	FORD
260773	16 1/4	13 1/8	1 7/8	MG	261956	18	19 11/16	3	INTERNATIONAL
260776	25	21 1/4	3	JOHN DEERE	261959	20 1/2	24 3/16	2 1/4	NAVISTAR
260783	28 1/2	26 7/8	3	JOHN DEERE	261960	20 1/2	24 3/16	3	NAVISTAR
260784	33	21 1/4	3	JOHN DEERE	261987	27	20 13/16	3	MACK TRUCKS
260799	21 3/8	21 3/8	2 1/4	FORD	261994	27	20 13/16	3	MACK TRUCKS
260804	18 7/8	19 1/8	2 1/4	MASSEY-FERGUSON	262004	28 7/8	23 5/8	3	MACK TRUCKS
260860	17 5/8	21 15/16	2 1/4	INTERNATIONAL	262050	21 1/2	18 9/16	2 1/4	JOHN DEERE
260950	16 1/2	16 7/8	2 1/4	MINNEAPOLIS MOLINE	262150	17 1/4	15 3/16	3	LIFT TRUCKS & LOADERS
260951	18 1/2	22 1/2	3	CHRYSLER	262163	22 5/8	18 9/16	3 3/4	INT'L HARVESTER
260957	15 7/8	14 5/8	3	LIFT TRUCKS & LOADERS	262751	13 1/4	20	3	JEEP
261007	14 1/2	15 3/4	2 1/4	HERCULES ENGINE	262797	18 3/4	19 1/8	2 1/4	MASSEY-FERGUSON
261022	19 7/8	23 5/8	2 1/4	GMC	262813	18 1/4	18	3	FIAT ALLIS
261102	17 1/4	19 11/16	3	HUBER	262820	14 3/4	14 1/16	2 1/4	FORD TRACTOR
261137	22 1/2	23 5/8	2 1/4	GMC	262829	19 3/4	18 3/4	1 7/8	FORD
261140	19 3/4	19 1/8	2 1/4	CONTINENTAL	262840	18	26 7/16	2 1/4	FORD
261155	27	29 13/16	2 1/4	INGERSOLL-RAND	262855	21 1/2	19 11/16	2 1/4	JOHN DEERE
261157	40	6 3/16	2 1/4	INGERSOLL-RAND	262882	11 3/8	14 3/8	1 7/8	AUSTIN
261181	20 1/4	25 5/16	3	STUDEBAKER	262885	18 3/8	19 3/8	1 7/8	FORD
261187	20	24 3/16	2 1/4	FORD TRUCK	262893	15 11/16	16 5/16	2 1/4	MB
261204	14 1/2	15 3/4	2 1/4	JEEP	262942	16	15 3/4	2 1/4	CASE/INTERNATIONAL
261219	19 11/16	18 9/16	2 1/4	OLIVER HART PARR	262944	21 5/8	18 9/16	3	CASE/INTERNATIONAL
261224	18 1/8	15 3/4	3	INT'L HARVESTER	262966	21	20 13/16	3	DRESSER INDUSTRIES
261284	16 3/4	18	3 3/4	LIFT TRUCKS & LOADERS	262968	16 7/8	19 1/8	3	LIFT TRUCKS & LOADERS
261289	22 7/16	19 11/16	3	FORD	262977	25 5/8	25 5/16	2 1/4	DODGE
261291	26 1/2	21 3/8	3	MACK TRUCKS	262996	20 1/4	18 9/16	2 1/4	GALION
261322	20 1/4	24 3/16	2 1/4	NAVISTAR	263030	24	24 3/16	3	NAVISTAR

Vista-Pro Radiator Core Catalog

(Sort by Model)

Model #	Height	Width	Depth	Application	Model #	Height	Width	Depth	Application
263032	15 3/8	16 5/16	2 1/4	OLIVER HART PARR	264123	13 3/4	18 9/16	3	AUSTIN
263062	19 11/16	18 9/16	3	OLIVER HART PARR	264124	16 7/8	15 3/16	2 1/4	AUSTIN
263064	16 1/4	15 3/16	2 1/4	OLIVER HART PARR	264131	30 1/2	24 3/16	4 1/2	CATERPILLAR
263093	19 1/2	18 9/16	2 1/4	LIFT TRUCKS & LOADERS	264250	17 1/8	12 3/8	3	TRIUMPH
263118	19 1/8	19 1/8	3	KOHLER ENGINES & GEN	264320	60	59 5/8	3	HAPPY YOUNG
263125	17 1/4	15 3/16	2 1/4	MASSEY-FERGUSON	264326	14 1/2	10 11/16	1 1/2	AUSTIN
263156	18 3/4	16 7/8	2 1/4	FORD TRACTOR	264337	17 3/8	18 9/16	3	ROVER
263180	20 1/4	23 3/4	1 7/8	NAVISTAR	264346	12 3/4	12 3/8	3	MG
263181	18	23 5/8	1 1/2	FORD	264347	16 3/8	16 5/16	2 1/4	TRIUMPH
263182	16 5/16	16 5/16	3	JEEP	264351	26	27 9/16	3	CATERPILLAR
263207	10	21 3/8	1 1/2	TRIUMPH	264353	37 3/4	27 9/16	4 1/2	CATERPILLAR
263211	36 13/16	39 15/16	4 1/2	CATERPILLAR	264355	17 1/4	18	2 1/4	JOHN DEERE
263213	20 3/8	15 3/4	3 3/4	INT'L HARVESTER	264370	25	21 15/16	2 1/4	NAVISTAR
263224	19 1/8	18 9/16	2 1/4	JOHN DEERE	264386	39	29 13/16	6	CATERPILLAR
263229	19 3/4	24 3/16	3 3/4	LIFT TRUCKS & LOADERS	265003	37 1/2	38 1/4	3	PETERBILT
263240	24 3/8	19 11/16	2 1/4	JOHN DEERE	265022	38	31 1/2	4 1/2	CATERPILLAR
263247	26 1/2	25 7/8	2 1/4	NAVISTAR	265024	40 3/8	25 7/8	6	CATERPILLAR
263254	18 5/8	18 9/16	2 1/4	FORD	265027	52	51 3/16	4 1/2	CATERPILLAR
263283	34 13/16	23 5/8	3	NAVISTAR	265028	26 3/4	26 7/16	3	CATERPILLAR
263308	21 3/4	25 5/16	2 1/4	DODGE	265029	37 9/16	43 5/16	3 3/4	CATERPILLAR
263354	24	25 5/16	4 1/2	CASE/INTERNATIONAL	265030	25 3/8	24 3/16	3	CATERPILLAR
263381	30	35 7/16	4 1/2	CATERPILLAR	265035	13 1/4	15 3/4	1 1/2	BMW
263435	28	26 7/16	3 3/4	MINNEAPOLIS MOLINE	265051	15 1/4	27 9/16	2 1/4	FERRARI
263450	19	18 9/16	2 1/4	OLIVER HART PARR	265097	16 5/8	22 1/2	1 7/8	MB
263458	18	17 7/16	2 1/4	LIFT TRUCKS & LOADERS	265178	33 1/2	33 3/16	5 1/4	CATERPILLAR
263483	25	23 5/8	3	PETTIBONE	265192	39 1/2	27 9/16	3	GMC
263563	13 1/4	20	1 7/8	JEEP	265203	37	32 5/8	3 3/4	FREIGHTLINER
263566	16 1/4	19 1/8	2 1/4	JEEP	265204	37	32 5/8	4 1/2	FREIGHTLINER
263616	17 1/4	19 1/8	3	JAGUAR	265205	28 3/8	25 5/16	3	GMC
263625	18 3/8	16 5/16	2 1/4	TRIUMPH	265206	28 3/8	25 5/16	2 1/4	GMC
263686	20 1/4	19 1/8	3	CASE/INTERNATIONAL	265236	37 3/4	37 11/16	4 1/2	FIAT ALLIS
263719	20 1/2	18 9/16	2 1/4	JOHN DEERE	265351	32 1/2	34 7/8	4 1/2	FIAT ALLIS
263802	17	16 7/8	2 1/4	OLIVER HART PARR	265353	35	39 15/16	3	KENWORTH
263877	35	29 1/4	3	WESTERN STAR	265360	19	18 9/16	3	LIFT TRUCKS & LOADERS
263878	32 1/2	28 1/8	2 1/4	GMC	265367	20 1/4	19 1/8	3	SPEED SPRAYER
263940	34	29 1/4	3	NAVISTAR	265368	24 1/2	24 3/4	3 3/4	SPEED SPRAYER
263952	22 1/2	18 9/16	3 3/4	JOHN DEERE	265375	38	38 1/4	4 1/2	DETROIT DIESEL
263953	22 7/16	19 1/8	3 3/4	INT'L HARVESTER	265399	19 1/4	17 7/16	3 3/4	LIFT TRUCKS & LOADERS
263962	28 3/8	28 1/8	2 1/4	GMC	265401	46	28 11/16	3	GMC
264002	16 1/4	14 1/16	3	LIFT TRUCKS & LOADERS	265409	19 13/16	19 1/8	2 1/4	FORD
264006	32	35 7/16	4 1/2	CATERPILLAR	265410	22 1/8	18	2 1/4	FORD
264012	37	27 9/16	3	MACK TRUCKS	265414	16 3/8	16 1/4	1 7/8	TRIUMPH
264016	42 13/16	39 15/16	4 1/2	CATERPILLAR	265415	17 3/8	16 5/16	2 1/4	TRIUMPH
264031	20 1/8	15 3/4	3 3/4	INT'L HARVESTER	265419	27 3/4	21 15/16	3	JOHN DEERE
264039	29 5/16	26 7/16	3	NAVISTAR	265431	29 1/2	24 3/16	3 3/4	FIAT ALLIS
264043	19 1/2	19 11/16	2 1/4	FORD	265439	32 1/4	27	4 1/2	DRESSER INDUSTRIES
264052	13 1/4	20	1 7/8	JEEP	265444	16 1/8	16 5/16	3	LIFT TRUCKS & LOADERS
264055	20 5/16	22 1/2	2 1/4	FORD	265445	18 1/8	18	3 3/4	LIFT TRUCKS & LOADERS
264056	20 5/16	22 1/2	3	FORD TRUCK	265452	39 1/8	36 9/16	3	WESTERN STAR
264064	30 1/2	26 7/16	4 1/2	CATERPILLAR	265458	14 7/8	20	2 1/4	LIFT TRUCKS & LOADERS
264065	40 7/16	30 15/16	6	CATERPILLAR	265469	22 1/2	19 1/8	4 1/2	JOHN DEERE
264085	26 1/2	25 5/16	3	NAVISTAR	265485	27 1/2	25 7/8	4 1/2	CASE/INTERNATIONAL
264089	24 1/4	25 5/16	3	NAVISTAR	265489	33 7/16	21 3/8	4 1/2	CATERPILLAR
264095	15 3/4	18 9/16	3	LIFT TRUCKS & LOADERS	265492	43 1/2	39 3/8	4 1/2	CATERPILLAR
264117	30	31 1/2	5 1/4	FIAT ALLIS	265495	19 1/8	15 3/16	2 1/4	JOHN DEERE

Vista-Pro Radiator Core Catalog

(Sort by Model)

Model #	Height	Width	Depth	Application	Model #	Height	Width	Depth	Application
265499	30	29 13/16	3 3/4	JOHN DEERE	265870	38	33 3/4	4 1/2	STEIGER TRACTOR
265503	17 1/2	16 5/16	2 1/4	FORD POWER PRODUCTS	265879	43 1/2	39 3/8	4 1/2	CATERPILLAR
265505	24 3/4	24 3/4	3	FRANKLIN LOGGER	265892	27 1/8	21 7/8	3 3/4	JOHN DEERE
265508	28 3/8	28 1/8	3	GMC	265893	27 3/4	27 9/16	3 3/4	JOHN DEERE
265509	22 1/2	23 5/8	3	GALION	265894	28	27	3 3/4	JOHN DEERE
265514	41	29 1/4	3	NAVISTAR	265898	26 3/4	27 1/2	3	CASE/INTERNATIONAL
265515	41	29 1/4	3 3/4	NAVISTAR	265901	22 5/8	18 3/4	3	INT'L HARVESTER
265521	12 3/4	19 11/16	2 1/4	LIFT TRUCKS & LOADERS	265902	22 5/8	18 3/4	3	INT'L HARVESTER
265533	24	24 3/4	3	SCHRAMM	265905	21 1/4	24 3/16	3	LIFT TRUCKS & LOADERS
265535	22 3/4	24 3/4	4 1/2	STEIGER TRACTOR	265907	22 3/4	31 1/2	4 1/2	MASSEY-FERGUSON
265536	28 7/8	29 1/4	5 1/4	STEIGER TRACTOR	265910	27 7/8	27 9/16	4 1/2	JOHN DEERE
265547	42 1/2	27 9/16	3	MACK TRUCKS	265914	30 1/8	26 1/4	3 3/4	JOHN DEERE
265551	37 1/2	37 11/16	4 1/2	CATERPILLAR	265919	18 1/4	18 1/8	2 1/4	FIAT ALLIS
265557	36 7/8	30 3/8	4 1/2	HENDRICKSON TRUCK	265920	20 3/4	19 3/8	3 3/4	GMC
265569	44	27 9/16	3	GMC	265921	19 11/16	18 3/4	1 3/4	FORD
265572	31 3/4	39 15/16	4 1/2	KENWORTH	265922	22 1/4	18 1/8	1 3/4	FORD
265577	31 7/8	27 9/16	3	NAVISTAR	265924	23	15 5/8	3	FORD
265580	45 1/2	45	4 1/2	CATERPILLAR	265926	19 1/16	26 1/4	3	FORD
265588	39 3/4	29 13/16	2 1/4	NAVISTAR	265927	25 3/4	20 5/8	2 7/8	PACKARD
265593	38 1/4	34 7/8	4 1/2	TEREX	265928	18 11/16	25 5/8	2 1/4	FORD
265601	38	34 7/8	3	VOLVO	265933	22 1/4	18 1/8	2 3/8	FORD
265602	15 3/8	19 11/16	2 1/4	LIFT TRUCKS & LOADERS	265934	22 1/8	16 7/8	2 7/8	FORD
265603	26 1/2	25 5/16	2 1/4	NAVISTAR	265938	12 1/2	18 3/4	2 1/4	ALFA ROMEO
265604	42 7/8	42 3/4	4 1/2	CATERPILLAR	265939	17	19 3/8	1 7/8	FORD
265605	42	39 15/16	4 1/2	CATERPILLAR	265948	26 1/2	25	3	FIAT ALLIS
265610	29 3/4	29 13/16	3 3/4	LIFT TRUCKS & LOADERS	265966	22	18 1/8	3	MASSEY-FERGUSON
265611	25	22 1/2	3 3/4	CASE/INTERNATIONAL	265967	16 7/8	15 5/8	2 1/4	CASE/INTERNATIONAL
265621	26 1/4	26 7/16	3 3/4	NAVISTAR	265971	20 3/8	20 5/8	2 1/4	CATERPILLAR
265624	17 1/8	14 5/8	2 1/4	CATERPILLAR	265972	31 3/4	28 3/4	3 3/4	MASSEY-FERGUSON
265628	21 3/4	21 3/8	4 1/2	CATERPILLAR	265974	19 1/8	18 1/8	2 1/4	MASSEY-FERGUSON
265629	22	22 1/2	2 1/4	CATERPILLAR	265981	20 1/2	20 5/8	3 3/4	FORD TRACTOR
265630	22	22 1/2	3	CATERPILLAR	265982	21 1/2	18 3/4	2 7/8	OLIVER HART PARR
265631	22 5/8	18	2 1/4	CATERPILLAR	265983	21 1/2	18 1/8	3	OLIVER HART PARR
265632	22 5/8	18	3	CATERPILLAR	265992	16 1/2	15 5/8	2 1/4	OLIVER HART PARR
265637	23 7/8	24 3/4	2 1/4	CATERPILLAR	265994	24	25 5/8	2 7/8	HESTON
265645	26 3/4	28 11/16	2 1/4	CATERPILLAR	265996	19 3/4	18 1/8	3 3/4	LIFT TRUCKS & LOADERS
265651	33 5/8	33 3/16	3 3/4	CATERPILLAR	265999	18 1/8	22 1/2	3	LIFT TRUCKS & LOADERS
265652	14	13 1/2	2 1/4	KOHLER ENGINES & GEN	266003	15 1/8	19 3/8	3	LIFT TRUCKS & LOADERS
265653	23	21 3/8	3	WAUKESHA	266004	14 7/8	19 3/8	2 7/8	LIFT TRUCKS & LOADERS
265657	29	34 5/16	2 1/4	MACK TRUCKS	266032	40	28 3/4	2 7/8	KENWORTH
265664	31 1/2	31 1/2	4 1/2	KOMATSU	266036	33 1/2	26 1/4	2 1/4	NAVISTAR
265669	38	38 1/4	4 1/2	CATERPILLAR	266043	21 7/8	19 3/8	3	LIFT TRUCKS & LOADERS
265670	34	33 3/16	5 1/4	CATERPILLAR	266044	20 1/4	19 3/8	2 1/4	LINCOLN ELECTRIC
265671	19 1/2	16 7/8	4 1/2	CATERPILLAR	266047	19 3/8	16 7/8	5 1/4	LIFT TRUCKS & LOADERS
265678	25 3/4	27 9/16	3 3/4	JOHN DEERE	266051	30	29 3/8	3 3/4	GMC
265680	38	35 7/16	3	VOLVO	266060	25 3/8	35 5/8	3 3/4	EUCLID
265754	17 1/8	22 1/2	3	LIFT TRUCKS & LOADERS	266070	17 1/2	16 1/4	3	FORD TRACTOR
265755	24	20 13/16	4 1/2	INT'L HARVESTER	266075	29	25 5/8	2 7/8	DRESSER INDUSTRIES
265788	12 5/8	17 1/2	1 3/4	ALFA ROMEO	266082	40	47 1/2	4 5/8	EUCLID
265789	18 3/4	14 3/8	1 1/4	AUDI	266083	14 3/4	19 3/8	3	LIFT TRUCKS & LOADERS
265821	24 1/4	26 1/4	2 3/8	FORD	266089	16 3/8	16 7/8	3	LIFT TRUCKS & LOADERS
265846	24	25	3	FORD TRACTOR	266093	20	23 5/8	2 1/4	FORD
265854	27 5/8	25 5/16	3	DRESSER INDUSTRIES	266096	17	18 3/4	3	LIFT TRUCKS & LOADERS
265858	38	36 9/16	4 1/2	CATERPILLAR	266097	18 1/8	18 1/8	2 3/8	FIAT ALLIS
265862	23	29 1/4	3 3/4	FIAT ALLIS	266100	40	28 3/4	2.875	KENWORTH

Vista-Pro Radiator Core Catalog

(Sort by Model)

Model #	Height	Width	Depth	Application	Model #	Height	Width	Depth	Application
266101	22 1/2	18 1/8	3	CASE/INTERNATIONAL	266304	29 3/4	30 5/8	3 3/4	JOHN DEERE
266105	18 5/8	23 1/8	2 7/8	LIFT TRUCKS & LOADERS	266305	26	26 1/4	3	JOHN DEERE
266113	19 1/8	15	3	JOHN DEERE	266307	21 1/2	25 5/8	4 5/8	JOHN DEERE
266122	43 7/8	36 1/4	4 5/8	LeTOURNEAU	266324	23	23 1/8	2 3/8	GALION
266127	17	20 5/8	2 7/8	LIFT TRUCKS & LOADERS	266325	16 3/4	15 5/8	2 1/4	GALION
266129	19 3/8	18 1/8	2 1/4	FIAT ALLIS	266329	21	23 1/8	3 3/4	DIEHOE
266132	13 3/4	17 1/2	2 7/8	LIFT TRUCKS & LOADERS	266331	18 1/4	21 1/4	2 7/8	DODGE
266133	18	19 3/8	3	LIFT TRUCKS & LOADERS	266335	20 7/8	20 5/8	2 7/8	FORD
266135	15 1/2	19 3/8	2 7/8	LIFT TRUCKS & LOADERS	266363	48 1/4	47 1/4	5 1/4	CATERPILLAR
266141	17 1/8	13 3/4	3	JOHN DEERE	266371	54 1/8	51 3/16	5 1/4	CATERPILLAR
266143	33 1/4	31 7/8	3 7/16	GMC	266373	21 1/2	15	1 3/4	TRIUMPH
266156	16 1/4	19 3/8	2 7/8	LIFT TRUCKS & LOADERS	266382	25 1/4	25 5/16	3	LIFT TRUCKS & LOADERS
266157	18 1/2	23 1/8	2 3/8	FIAT ALLIS	266390	20 3/8	18 3/4	2 1/4	LIFT TRUCKS & LOADERS
266159	18 5/8	18 3/4	2 7/8	LIFT TRUCKS & LOADERS	266392	35	41 1/4	2 1/4	KENWORTH
266160	30	35 5/8	3	CATERPILLAR	266408	26 1/2	25 5/8	1 3/4	NAVISTAR
266162	35 15/16	36 1/4	3 3/4	CATERPILLAR	266417	38	26 1/4	2 3/8	NAVISTAR
266163	24 7/8	26 1/4	3	FIAT ALLIS	266421	24	21 7/8	2 3/8	NAVISTAR
266168	26 1/4	18 1/8	3 3/4	CASE/INTERNATIONAL	266425	17 1/2	18 1/8	2 1/4	CASE/INTERNATIONAL
266178	20 1/4	23 3/4	2 1/4	NAVISTAR	266426	20 5/8	19 3/8	2 1/4	JOHN DEERE
266182	27 1/2	26 1/4	4 5/8	CASE/INTERNATIONAL	266428	19 3/8	20	3	LIFT TRUCKS & LOADERS
266183	21	21 1/4	3	LIFT TRUCKS & LOADERS	266431	21 3/4	13 3/4	2 7/8	JOHN DEERE
266187	28 1/4	29 3/8	2 3/8	CATERPILLAR	266437	20 1/8	16 1/4	4 5/8	JOHN DEERE
266190	15 3/4	19 3/8	2 1/4	LIFT TRUCKS & LOADERS	266441	20 1/8	19 3/8	3	JOHN DEERE
266193	28 1/4	21 1/4	3	JOHN DEERE	266443	17	14 3/8	2 1/4	JOHN DEERE
266199	24 1/4	26 1/4	3 3/4	NAVISTAR	266449	58 5/8	57 3/8	6	CATERPILLAR
266203	31 1/8	38 1/8	4 5/8	WAGONER TRACTOR	266455	42 13/16	40 1/2	4 1/2	CATERPILLAR
266205	17 1/8	19 3/8	3	LIFT TRUCKS & LOADERS	266460	41 9/16	21 3/8	3 3/4	CATERPILLAR
266209	18 3/4	21 7/8	2 1/4	LIFT TRUCKS & LOADERS	266461	42 13/16	34 7/8	3 3/4	CATERPILLAR
266210	17 1/8	13 3/4	2 7/8	JOHN DEERE	266463	45	47 13/16	5 1/4	CATERPILLAR
266215	26 9/16	25 5/8	3 3/4	FORD TRACTOR	266464	45 5/16	43 7/8	3 3/4	CATERPILLAR
266216	21 7/8	19 3/8	3 3/4	LIFT TRUCKS & LOADERS	266466	47 1/2	43 5/16	5 1/4	CATERPILLAR
266219	26 1/2	25 5/8	3 7/16	FORD TRUCK	266469	42	39 3/8	2 1/4	CATERPILLAR
266220	25 1/2	19 3/8	3 3/4	JOHN DEERE	266474	45 3/4	25 7/8	4 1/2	CATERPILLAR
266223	21 1/4	22 1/2	2 7/8	LIFT TRUCKS & LOADERS	266493	45 3/4	25 7/8	3 3/4	CATERPILLAR
266229	24 1/4	26 1/4	3	NAVISTAR	266540	29 7/8	26 1/4	3 7/16	JOHN DEERE
266233	16 7/8	17 1/2	3	FIAT ALLIS	266541	25 1/2	19 3/8	3 7/16	JOHN DEERE
266234	16 7/8	20 5/8	2 7/8	CASE/INTERNATIONAL	266542	25 1/2	19 3/8	3 7/16	JOHN DEERE
266236	29 5/16	29 3/8	5 1/4	CATERPILLAR	266544	29 1/4	21 7/8	3 7/16	JOHN DEERE
266237	16 5/8	18 1/8	3 3/4	CATERPILLAR	266546	27 1/8	21 7/8	3 7/16	JOHN DEERE
266240	25 1/2	19 3/8	3	JOHN DEERE	266547	27 1/8	21 7/8	2 7/8	JOHN DEERE
266242	17 1/2	16 1/4	3	INT'L HARVESTER	266548	27 3/4	25 7/8	3 3/4	CATERPILLAR
266246	19 7/8	19 3/8	3	LIFT TRUCKS & LOADERS	266565	32 7/8	20 13/16	6	JOHN DEERE
266249	18 3/8	18 1/8	2 1/4	FORD TRACTOR	266584	46	32 1/16	5 1/4	LIFT TRUCKS & LOADERS
266250	27 15/16	25 5/8	2 7/8	INT'L HARVESTER	266594	42	34 7/8	3 3/4	PETERBILT
266256	16 1/4	17 1/2	2 3/8	LIFT TRUCKS & LOADERS	266604	48	46 1/8	3	CATERPILLAR
266258	24	29 3/8	4 5/8	FIAT ALLIS	266620	22 3/4	20 13/16	3	WAUKESHA
266270	27 3/8	24 3/8	4 5/8	CASE/INTERNATIONAL	266846	36 1/4	34 3/8	2.875	PETERBILT
266271	27 1/4	26 7/8	2 3/8	CASE/INTERNATIONAL	268007	20 1/8	21	3 3/4	FORD TRUCK
266273	21 5/8	17 1/2	2 7/8	CASE/INTERNATIONAL	269137	48	47 13/16	4.5	OSHKOSH
266275	20 7/8	24 3/8	2 7/8	CASE/INTERNATIONAL	270089	20 1/2	15 3/4	2 1/4	CASE/INTERNATIONAL
266281	19	23 1/8	3	CASE/INTERNATIONAL	270093	36 1/8	25 5/16	5 1/4	DETROIT DIESEL
266282	19	23 3/4	3	CASE/INTERNATIONAL	270095	25 15/16	20 13/16	3	CATERPILLAR
266291	32 1/8	26 7/8	4 5/8	CATERPILLAR	270103	22 5/8	22 1/2	3	CATERPILLAR
266293	21 3/4	21 1/4	4 5/8	CATERPILLAR	270155	23 1/2	20 13/16	3	CHRYSLER
266300	29 1/8	24 3/8	2 7/8	CONTINENTAL	270162	15 3/4	14 5/8	2 1/4	JOHN DEERE

Vista-Pro Radiator Core Catalog

(Sort by Model)

Model #	Height	Width	Depth	Application	Model #	Height	Width	Depth	Application
270185	18 3/4	21 3/8	3	DODGE	272521	31 1/2	31 1/2	4 1/2	KOMATSU
270199	36 1/8	25 5/16	4 1/2	DETROIT DIESEL	272523	41 1/8	40 1/2	5 1/4	KOMATSU
270200	30 1/2	26 7/16	3 3/4	DETROIT DIESEL	272529	22 5/8	21 3/8	2 1/4	WAUKESHA
270207	35	34 7/8	3 3/4	HAPPY YOUNG	272530	22 5/8	21 3/8	3	WAUKESHA
270246	18	16 5/16	3	INT'L HARVESTER	272531	22 5/8	20 13/16	3	WAUKESHA
270271	17 3/8	15 3/4	2 1/4	MASSEY-FERGUSON	272533	27	21 3/8	3	WAUKESHA
270273	16 1/4	16 5/16	2 1/4	OLIVER HART PARR	272534	28 1/2	27 9/16	3	WAUKESHA
270298	17 7/8	22 1/2	3	INTERNATIONAL	272542	38	33 3/16	4 1/2	WAUKESHA
270355	30	28 11/16	3 3/4	GMC	272557	26 3/4	27	3	CATERPILLAR
270441	29 15/16	26 7/8	2 1/4	MINNEAPOLIS MOLINE	272560	27 3/4	21 1/2	5 1/4	CATERPILLAR
270504	30	27	3 3/4	WAUKESHA	272564	29 5/8	30 5/8	6.125	MISC
270594	20 7/8	22 1/2	3	LINCOLN ELECTRIC	272567	32	31 1/2	4 1/2	CATERPILLAR
270633	22 3/8	22 1/2	2 1/4	MINNEAPOLIS MOLINE	272568	33	28 11/16	4 1/2	CATERPILLAR
270639	32	34 5/16	3 3/4	MURPHY DIESEL	272570	34	33	4 1/2	CATERPILLAR
270646	36 1/8	25 5/16	3 3/4	DETROIT DIESEL	272571	34	33	5 1/4	CATERPILLAR
270667	17 1/4	18 9/16	3	LIFT TRUCKS & LOADERS	272577	38	36	5 1/4	CATERPILLAR
270709	20 1/4	19 3/8	2 1/4	CONTINENTAL	272580	41	37 1/2	6	CATERPILLAR
270860	17 7/8	22 1/2	2 1/4	INTERNATIONAL	272581	41 1/2	31 1/2	3 3/4	CATERPILLAR
270920	22 5/8	18 9/16	2 1/4	INT'L HARVESTER	272582	42 13/16	34 1/2	3 3/4	CATERPILLAR
270925	23 3/4	21 1/4	3	DRESSER INDUSTRIES	272585	44 15/16	39	5 1/4	CATERPILLAR
270950	16 5/8	16 7/8	2 1/4	MINNEAPOLIS MOLINE	272586	44 15/16	39	6	CATERPILLAR
271007	14 1/2	15 3/16	2 1/4	MONTGOMERY WARD	272587	32 1/4	29 13/16	3 3/4	CASE/INTERNATIONAL
271032	35	39 15/16	4 1/2	KENWORTH	272593	48 1/4	47 1/2	5 1/4	CATERPILLAR
271140	19 3/4	19 11/16	2 1/4	LINCOLN ELECTRIC	272604	35 15/16	36	4 1/2	CATERPILLAR
271350	33 1/2	39 3/8	3	CATERPILLAR	272605	42 7/8	42 3/4	3 3/4	CATERPILLAR
271377	27 15/16	26 7/16	2 1/4	MINNEAPOLIS MOLINE	272606	48 1/4	47 13/16	6	CATERPILLAR
271390	17 1/2	16 5/16	2 1/4	OLIVER HART PARR	272609	58 1/2	57 1/2	6	CATERPILLAR
271398	37 1/2	28 1/8	4 1/2	PETERBILT	272612	33 7/16	27 1/2	3 3/4	CATERPILLAR
271472	23 7/16	24 3/16	3	CATERPILLAR	272623	28	20	4 1/2	JOHN DEERE
271475	18 1/2	15 3/4	2 1/4	JOHN DEERE	272629	36	53 7/16	3 3/4	EUCLID
271675	22 3/4	16 7/8	3	FORD TRUCK	272635	44	53 7/16	3 3/4	EUCLID
271925	21 5/8	20 13/16	2 1/4	FORD TRUCK	272639	24	19 11/16	3	FORD TRACTOR
271936	30 3/8	36 9/16	3	CATERPILLAR	272640	24	19 11/16	3 3/4	FORD TRACTOR
271945	18	19 11/16	2 1/4	INTERNATIONAL	272642	20 1/4	18 9/16	3	DETROIT DIESEL
272416	32	37 11/16	3 3/4	EAGLE COACH	272648	39 1/4	36	4 1/2	DETROIT DIESEL
272450	41 1/2	34 7/8	3 3/4	FIAT ALLIS	272651	42	34 7/8	4 1/2	DETROIT DIESEL
272456	30	29	4 1/2	FIAT ALLIS	272652	42	41 5/8	3 3/4	DETROIT DIESEL
272461	24 3/8	27 9/16	3 3/4	CASE/INTERNATIONAL	272653	44	41 5/8	4 1/2	DETROIT DIESEL
272462	25	22 1/2	4 1/2	CASE/INTERNATIONAL	272655	50	50 1/16	3 3/4	DETROIT DIESEL
272465	35 13/16	20 1/2	4 1/2	CASE/INTERNATIONAL	272656	50	50 1/16	4 1/2	DETROIT DIESEL
272474	35 1/2	28	6	LIFT TRUCKS & LOADERS	272661	22 1/2	22 1/2	2 1/4	GARDNER DENVER
272488	38 1/16	36	3	CUMMINS ENGINE	272677	28 3/8	25 7/8	3	HALLIBURTON
272489	42	42 3/16	4 1/2	CUMMINS ENGINE	272683	43	38 13/16	5 1/4	HALLIBURTON
272492	48	46 1/8	4 1/2	CUMMINS ENGINE	272684	43	42 3/16	3 3/4	HALLIBURTON
272493	54	48 15/16	3 3/4	CUMMINS ENGINE	272687	60	43 5/16	5 1/4	HALLIBURTON
272502	28	20	4 1/2	JOHN DEERE	272689	20 3/4	29 1/4	4 1/2	INT'L HARVESTER
272506	31	27 9/16	3	JOHN DEERE	272691	24	21	4 1/2	INT'L HARVESTER
272507	32 1/2	29	5 1/4	JOHN DEERE	272694	27 13/16	20 1/2	4 1/2	INT'L HARVESTER
272508	32 3/4	20 1/2	6	JOHN DEERE	272695	27 13/16	20 1/2	4 1/2	INT'L HARVESTER
272509	34 1/4	27 9/16	3 3/4	JOHN DEERE	272696	29 1/2	28	4 1/2	INT'L HARVESTER
272510	35	46	6	JOHN DEERE	272697	29 5/8	32 1/16	4 1/2	DRESSER INDUSTRIES
272511	38	16 5/16	5 1/4	JOHN DEERE	272717	36 3/4	47 13/16	4 1/2	WABCO
272512	38	16 1/2	5 1/4	JOHN DEERE	272723	16 3/4	19 11/16	1 1/2	LINCOLN ELECTRIC
272514	28 3/4	25	3 3/4	LIFT TRUCKS & LOADERS	272725	17 1/2	18	2 1/4	MASSEY-FERGUSON
272516	29 5/8	25 5/16	3	JOHN DEERE	272726	37	34 5/16	3	MASSEY-FERGUSON

Vista-Pro Radiator Core Catalog

(Sort by Model)

Model #	Height	Width	Depth	Application	Model #	Height	Width	Depth	Application
272731	16 5/8	19 11/16	2 1/4	MILLER ELECTRIC	272935	29 1/4	29 1/4	4 1/2	P & H MANUFACTURING
272734	21 1/4	21 3/8	2 1/4	ONAN	272938	28	39 1/2	4 1/2	REX
272737	39 5/16	38 13/16	2 1/4	QUINCY COMPRESSOR	272942	48 1/4	63 9/16	3 3/4	SCHRAMM
272755	29 1/4	22	3 3/4	JOHN DEERE	272945	37 7/8	34 5/16	4 1/2	STEIGER TRACTOR
272756	29	22	3 3/4	JOHN DEERE	272946	34 5/8	23	3 3/4	TERRA-GATOR/TERRA-TR
272757	27 1/8	21 1/2	3 3/4	JOHN DEERE	272947	33	26	6	TIMBER JACK
272765	30 1/4	26 1/2	2 1/4	FORD TRUCK	272954	45	45	3 3/4	WAUKESHA
272773	16 1/4	16	3	LIFT TRUCKS & LOADERS	272962	27	21 1/4	2 7/8	WAUKESHA
272776	28 3/4	26 7/16	2 1/4	FORD TRUCK	273032	15 1/2	16 5/16	2 1/4	OLIVER HART PARR
272779	25 7/8	26 1/2	3 3/4	FIAT ALLIS	273289	29	34 5/16	4 1/2	V.M.E.
272780	27 1/2	24	5 1/4	FIAT ALLIS	273413	21 1/2	19 11/16	2 1/4	JOHN DEERE
272784	27 3/4	26 7/16	4 1/2	CUMMINS ENGINE	273419	40	47 1/4	4 1/2	EUCLID
272788	25 5/8	24 3/4	3 3/4	CASE/INTERNATIONAL	273439	18	23 1/16	3	LIFT TRUCKS & LOADERS
272789	32 1/4	28 11/16	3 3/4	CASE/INTERNATIONAL	273448	21 3/16	18	2 1/4	MINNEAPOLIS MOLINE
272790	28 3/4	18	4 1/2	CASE/INTERNATIONAL	273459	23	23 1/16	4 1/2	SPEED SPRAYER
272792	38 5/16	30	4 1/2	CATERPILLAR	273468	18	16 1/4	2 1/4	WITTE
272793	39	59 5/8	4 1/2	CATERPILLAR	273473	19 1/2	18	3	LIFT TRUCKS & LOADERS
272795	42	40	3 3/4	CATERPILLAR	273617	24 3/8	19 3/8	2 15/16	JOHN DEERE
272799	40	36	4 1/2	CATERPILLAR	273629	26 5/8	21 7/8	3 11/16	JOHN DEERE
272801	32	32 1/16	3 3/4	CATERPILLAR	273800	20 1/4	16 1/4	3 15/16	JOHN DEERE
272802	33 1/4	28 11/16	4 1/2	CATERPILLAR	273801	20 1/4	16 1/4	3 15/16	JOHN DEERE
272803	33 7/16	33 1/2	3 3/4	CATERPILLAR	273805	28 5/8	21 7/8	3 15/16	JOHN DEERE
272807	42	39 3/8	3	CATERPILLAR	273806	29 3/8	21 7/8	3 7/16	JOHN DEERE
272808	41 1/2	31 1/2	4 1/2	CATERPILLAR	273812	14 7/8	18 3/4	2 7/8	LIFT TRUCKS & LOADERS
272809	42 13/16	34 1/2	3 3/4	CATERPILLAR	273813	18 1/2	20	2 3/8	LIFT TRUCKS & LOADERS
272811	45 5/16	44	3 3/4	CATERPILLAR	274100	57 7/8	60 3/16	5 1/4	CAT-LeMASTER
272814	50	49 1/2	5 1/4	CATERPILLAR	274102	43 3/4	43 7/8	5 1/4	CAT-LeMASTER
272816	50	48 3/8	3 3/4	CATERPILLAR	274104	43 3/4	47 1/4	5 1/4	CAT-LeMASTER
272821	37	34 5/16	4 1/2	LIFT TRUCKS & LOADERS	274122	39 3/16	32 1/16	5 1/4	CAT-LeMASTER
272823	26 7/8	33 3/4	4 1/2	CHAMPION	274130	39 3/16	37 1/8	5 1/4	CAT-LeMASTER
272825	37 1/2	37 1/2	3 7/16	CRANE CARRIER	274132	33 7/8	36	5 1/4	CAT-LeMASTER
272837	22	21 15/16	3	CUMMINS ENGINE	274136	50 3/4	52 7/8	5 1/4	CAT-LeMASTER
272845	39 1/4	32 5/8	4 1/2	DETROIT DIESEL	274144	36 1/8	33 3/16	5 1/4	CAT-LeMASTER
272858	40	47 1/4	4 1/2	EUCLID	274148	29 1/8	32 1/16	5 1/4	CAT-LeMASTER
272865	41 3/4	40 1/2	4 1/2	DETROIT DIESEL	274150	40 3/4	34 7/8	5 1/4	CAT-LeMASTER
272867	48	48 3/8	5 1/4	DETROIT DIESEL	274152	43 3/4	47 1/4	5 1/4	CAT-LeMASTER
272869	38	33 1/2	6	DETROIT DIESEL	274156	39 3/16	39 15/16	5 1/4	CAT-LeMASTER
272871	50	50 1/16	4 1/2	DETROIT DIESEL	274162	43 3/4	43 7/8	5 1/4	CAT-LeMASTER
272875	42 1/2	42 1/2	3 7/16	DETROIT DIESEL	274164	43 3/4	43 7/8	5 1/4	CAT-LeMASTER
272876	39 1/8	33 3/4	3 3/4	DETROIT DIESEL	274166	40 3/4	38 13/16	5 1/4	CAT-LeMASTER
272877	36	33 3/16	3 3/4	DETROIT DIESEL	274168	58	56 1/4	5 1/4	CAT-LeMASTER
272879	35	35	2 7/8	GROVE WORLDWIDE	274170	29 1/8	24 3/4	4 1/2	CAT-LeMASTER
272880	43	38 1/4	5 1/4	HALLIBURTON	274172	29 1/8	29 1/4	4 1/2	CAT-LeMASTER
272883	24 3/4	21 7/8	2 3/8	DETROIT DIESEL	274174	43 3/4	42 3/4	5 1/4	CAT-LeMASTER
272884	24 7/8	21 15/16	3	DETROIT DIESEL	274178	69 3/8	72	5 1/4	CAT-LeMASTER
272896	34	16 1/2	5 1/4	JOHN DEERE	274180	39 3/16	37 1/8	5 1/4	CAT-LeMASTER
272898	34	31 1/2	4 1/2	JOHN DEERE	274192	39 3/16	32 1/16	5 1/4	CAT-LeMASTER
272900	26 3/4	21 7/8	2 7/8	JOHN DEERE	274194	39 3/16	37 1/8	5 1/4	CAT-LeMASTER
272902	41 1/2	26 7/8	3 15/16	JOHN DEERE	274202	38 1/2	41 1/2	4 1/2	FIAT ALLIS
272903	30 1/2	16 5/16	4 1/2	JOHN DEERE	274204	28 1/4	24	3 3/4	CATERPILLAR
272905	49 3/4	33 3/4	3 3/4	JOHN DEERE	274220	39 3/16	37 1/8	5 1/4	CAT-LeMASTER
272910	45	30 1/2	4 1/2	KOMATSU	274222	29 1/8	24 3/4	4 1/2	CAT-LeMASTER
272916	62 1/4	55 1/2	5 1/4	KOMATSU	274224	40 3/4	43 5/16	5 1/4	CAT-LeMASTER
272926	29 3/4	28 11/16	3 3/4	LORAIN SHOVEL	274228	43 3/4	42 3/4	5 1/4	CAT-LeMASTER
272933	36	34 7/8	3 3/4	P & H MANUFACTURING	274238	43 3/4	47 1/4	5 1/4	CAT-LeMASTER

Vista-Pro Radiator Core Catalog

(Sort by Model)

Model #	Height	Width	Depth	Application	Model #	Height	Width	Depth	Application
274256	69 3/8	78 3/4	5 1/4	CAT-LeMASTER	276741	17 1/2	16 5/16	3	INT'L HARVESTER
274282	50 3/4	51 3/4	5 1/4	CAT-LeMASTER	276742	15	16 5/16	3	INT'L HARVESTER
274290	20 1/8	24 3/16	2 1/4	FORD TRUCK	276785	40 3/4	36 9/16	3 3/4	GENERAL ELECTRIC
274400	23 3/4	22 1/2	3	DRESSER INDUSTRIES	276804	14 3/4	14 1/16	2 1/4	FORD TRACTOR
274402	24 1/2	28 3/4	3	DRESSER INDUSTRIES	276855	30 1/2	24	4 1/2	CATERPILLAR
274436	21 3/8	19 11/16	2 1/4	LINCOLN ELECTRIC	276882	15 3/4	14 5/8	2 1/4	LIFT TRUCKS & LOADERS
274469	27 15/16	26 1/4	3	MINNEAPOLIS MOLINE	276912	17 1/4	22 1/2	3	LIFT TRUCKS & LOADERS
274471	21 3/16	18 3/4	2 1/4	MINNEAPOLIS MOLINE	277040	28	25 7/8	3	JOHN DEERE
274507	35 3/4	34 3/8	3	AJAX	277065	32 1/4	27	4 1/2	DRESSER INDUSTRIES
274510	21	22	2 1/4	FIAT ALLIS	277122	32 1/2	34 1/2	4 1/2	FIAT ALLIS
274513	30	29	3 3/4	FIAT ALLIS	277125	20 1/4	19	3	CASE/INTERNATIONAL
274571	22 7/8	18 3/4	3	CASE/INTERNATIONAL	277126	22 1/2	25	3 3/4	CASE/INTERNATIONAL
274598	31 3/16	36	3	CATERPILLAR	277129	29 5/8	33 3/16	3	CATERPILLAR
274602	23 7/16	24 3/16	3	CATERPILLAR	277135	39 7/16	22 1/2	6	CATERPILLAR
274630	15 1/2	16 7/8	2 1/4	LIFT TRUCKS & LOADERS	277136	42 7/8	42 1/2	3 3/4	CATERPILLAR
274736	28 9/16	28 11/16	3 3/4	GALION	277146	33	32 5/8	4 1/2	CUMMINS ENGINE
274783	22 5/8	18 3/4	3	INT'L HARVESTER	277161	22 1/2	18 9/16	3	JOHN DEERE
274790	22 7/16	19 11/16	3 3/4	INT'L HARVESTER	277197	15 7/8	18 9/16	3	LIFT TRUCKS & LOADERS
274842	30	26 7/8	3	WAUKESHA	277207	21 1/2	18 9/16	3	OLIVER HART PARR
274843	36	33 1/8	3	WAUKESHA	277345	21 5/8	18 9/16	3	CASE/INTERNATIONAL
274897	26 5/8	24 3/8	3	WAUKESHA	277346	22 1/2	18 1/2	3	CASE/INTERNATIONAL
274939	25 3/8	25 5/8	3	CATERPILLAR	277350	33 7/16	21 1/2	4 1/2	CATERPILLAR
274942	36 13/16	40	4 1/2	CATERPILLAR	277353	37 1/2	37 1/2	4 1/2	CATERPILLAR
274953	24 1/2	19 11/16	2 1/4	JOHN DEERE	277354	37 5/8	38 1/2	4 1/2	CATERPILLAR
274967	26 5/8	25 7/8	2 1/4	NAVISTAR	277364	24 7/8	19 11/16	2 1/4	JOHN DEERE
274984	19 3/8	18 9/16	2 1/4	FIAT ALLIS	277365	25	21 1/2	3	JOHN DEERE
274988	35 15/16	36	4 1/2	CATERPILLAR	277366	27 3/4	21 1/2	3	JOHN DEERE
274989	20 15/16	42 1/2	4 1/2	CATERPILLAR	277396	28 3/16	25	3 3/4	INT'L HARVESTER
274991	22 5/8	18	3	CASE/INTERNATIONAL	277402	19 3/4	18	3	LIFT TRUCKS & LOADERS
275008	28	28 11/16	4 1/2	EUCLID	277411	31 3/4	28 11/16	3 3/4	MASSEY-FERGUSON
275011	20 1/8	16 1/4	3	INT'L HARVESTER	277419	37 1/2	28 1/8	5 1/4	PETERBILT
275021	43 7/8	36	4 1/2	LeTOURNEAU	277422	15 3/4	16 1/2	3	LIFT TRUCKS & LOADERS
275088	24	25	4 1/2	CASE/INTERNATIONAL	277429	30 1/4	29 1/4	2 1/4	NAVISTAR
275089	19 1/4	18 9/16	3	CASE/INTERNATIONAL	277717	16 1/4	18	3	FIAT ALLIS
275091	22 5/8	24 1/2	3	CATERPILLAR	277858	36	32 5/8	4 1/2	CUMMINS ENGINE
275109	18 1/4	15 3/4	2 1/4	INT'L HARVESTER	277959	29 3/8	26 7/16	3	NAVISTAR
275112	19 1/8	15 3/16	2 1/4	JOHN DEERE	278428	48	37 11/16	4 1/2	MANITOWOC
275113	19 1/8	18 9/16	2 1/4	JOHN DEERE	278437	19 1/8	18	2 1/4	MASSEY-FERGUSON
275214	30	35 1/2	3	CATERPILLAR	278459	19 5/8	18 9/16	2 1/4	OLIVER HART PARR
275223	34 13/16	23 5/8	3 3/4	NAVISTAR	278465	23 3/4	20 1/4	3 3/4	OLIVER HART PARR
275226	29 5/8	32	5 1/4	DRESSER INDUSTRIES	278590	15 1/4	15 3/4	2 1/4	FIAT ALLIS
275230	28 7/8	24 3/16	3	MACK TRUCKS	278596	16 1/2	17 7/16	3	LIFT TRUCKS & LOADERS
275233	17 1/4	15 3/16	2 1/4	MASSEY-FERGUSON	278599	17 1/4	17 7/16	2 1/4	LIFT TRUCKS & LOADERS
275234	40	32 5/8	4 1/2	LIFT TRUCKS & LOADERS	278614	20	23	3 3/4	FIAT ALLIS
275314	29	32 1/16	4 1/2	EUCLID	278620	21 3/4	18	3	FIAT ALLIS
275361	37	27 9/16	3 3/4	MACK TRUCKS	278621	23	29	3 3/4	FIAT ALLIS
275365	24	25 1/2	3	MASSEY-FERGUSON	278625	23 3/4	23 1/16	3	FIAT ALLIS
275392	44 3/8	36	6	CATERPILLAR	278626	24	29 1/4	4 1/2	FIAT ALLIS
275433	41 1/2	34 7/8	3 3/4	FIAT ALLIS	278639	30	31 1/2	4 1/2	FIAT ALLIS
275439	39 1/16	38	6	CATERPILLAR	278640	30	28 1/8	4 1/2	FIAT ALLIS
275441	44 5/16	40 1/2	6	CATERPILLAR	278644	34 1/4	38 1/4	3 3/4	FIAT ALLIS
275446	22	18	3 3/4	JOHN DEERE	278762	18 1/4	23 1/16	3	CASE/INTERNATIONAL
275463	41 5/8	41 5/8	3 3/4	DETROIT DIESEL	278763	19	23 5/8	3	CASE/INTERNATIONAL
275482	18 1/2	18 9/16	3	LUFKIN	278764	19	23 5/8	2 1/4	CASE/INTERNATIONAL
275959	24 1/4	26 1/4	2 7/8	FORD	278767	19 3/8	19 1/2	3	CASE/INTERNATIONAL

Vista-Pro Radiator Core Catalog

(Sort by Model)

Model #	Height	Width	Depth	Application	Model #	Height	Width	Depth	Application
278770	19 5/8	21 3/8	2 1/4	CASE/INTERNATIONAL	279315	23 3/4	21	4 1/2	INT'L HARVESTER
278773	21 1/4	23 1/16	3	CASE/INTERNATIONAL	279334	39 5/8	41 1/2	6	DRESSER INDUSTRIES
278782	22 3/4	18	3	CASE/INTERNATIONAL	279339	47 7/8	40 1/2	4 1/2	DRESSER INDUSTRIES
278784	23 3/4	22 1/2	3	CASE/INTERNATIONAL	279433	23 1/4	21 3/8	2 1/4	OLIVER HART PARR
278786	25 3/8	18	3 3/4	CASE/INTERNATIONAL	279437	23	23 5/8	2 1/4	JOY MANUFACTURING
278787	25 7/8	29 1/2	3 3/4	CASE/INTERNATIONAL	279488	10 5/8	16 5/16	3	LIFT TRUCKS & LOADERS
278789	26 5/8	30 3/8	3 3/4	CASE/INTERNATIONAL	279489	11 1/2	19 1/8	2 1/4	LIFT TRUCKS & LOADERS
278794	27 1/2	26	4 1/2	CASE/INTERNATIONAL	279493	12 3/4	19 11/16	2 1/4	LIFT TRUCKS & LOADERS
278795	32	27	4 1/2	CASE/INTERNATIONAL	279505	14 1/2	19 1/8	2 1/4	LIFT TRUCKS & LOADERS
278807	26	27 1/2	3	CATERPILLAR	279508	14 5/8	19 1/8	2 1/4	LIFT TRUCKS & LOADERS
278809	26 3/4	24	3	CATERPILLAR	279511	14 3/4	19 1/8	3	LIFT TRUCKS & LOADERS
278825	33 3/4	27 1/2	2 1/4	CATERPILLAR	279512	15	19 1/8	2 1/4	LIFT TRUCKS & LOADERS
278837	40	37 1/2	6	CATERPILLAR	279514	15 1/4	19 1/8	3	LIFT TRUCKS & LOADERS
278839	42	40	5 1/4	CATERPILLAR	279515	15 1/4	19 11/16	2 1/4	LIFT TRUCKS & LOADERS
278904	36	32 5/8	3 3/4	CUMMINS ENGINE	279519	15 3/4	18	3	LIFT TRUCKS & LOADERS
278915	16 1/4	14 5/8	2 1/4	DAVID BROWN TRACTOR	279520	15 3/4	16 5/16	3 3/4	LIFT TRUCKS & LOADERS
278917	15 1/2	14 5/8	2 1/4	JOHN DEERE	279522	15 3/4	17 7/16	3	LIFT TRUCKS & LOADERS
278918	17 1/8	13 1/2	2 1/4	JOHN DEERE	279524	15 3/4	19 11/16	2 1/4	LIFT TRUCKS & LOADERS
278919	18 1/2	15 3/4	3	JOHN DEERE	279525	15 3/4	19 1/8	2 1/4	LIFT TRUCKS & LOADERS
278920	19 3/4	20 1/4	2 1/4	JOHN DEERE	279533	16	16 5/16	3	LIFT TRUCKS & LOADERS
278921	19 3/4	20 1/4	3	JOHN DEERE	279534	16	16 5/16	3	LIFT TRUCKS & LOADERS
278925	20 1/2	18 9/16	3	JOHN DEERE	279535	16	17 7/16	3	LIFT TRUCKS & LOADERS
278927	21	16 7/8	2 1/4	JOHN DEERE	279536	16	16 5/16	3 3/4	LIFT TRUCKS & LOADERS
278929	21 3/8	24 3/4	2 1/4	JOHN DEERE	279538	16	17 7/16	2 1/4	LIFT TRUCKS & LOADERS
278933	21 1/2	25	3 3/4	JOHN DEERE	279539	16	16 7/8	3	LIFT TRUCKS & LOADERS
278942	22 1/2	19 1/8	4 1/2	JOHN DEERE	279540	16	14 5/8	3	LIFT TRUCKS & LOADERS
278945	23 7/8	20 13/16	3	JOHN DEERE	279541	16 1/8	19 1/8	2 1/4	LIFT TRUCKS & LOADERS
278947	24	37 1/8	3	JOHN DEERE	279542	16 1/8	19 1/8	3	LIFT TRUCKS & LOADERS
278948	24	37 1/8	3 3/4	JOHN DEERE	279545	16 1/4	15 3/4	2 1/4	LIFT TRUCKS & LOADERS
278955	27	21 3/8	3 3/4	JOHN DEERE	279551	16 1/2	17 7/16	3 3/4	LIFT TRUCKS & LOADERS
278957	27 1/2	21 3/8	3	JOHN DEERE	279553	16 1/2	23 1/16	3	LIFT TRUCKS & LOADERS
278960	27 7/8	27 1/2	4 1/2	JOHN DEERE	279554	16 5/8	19 1/8	2 1/4	LIFT TRUCKS & LOADERS
278961	28	27	3	JOHN DEERE	279564	17 1/8	22 1/2	3	LIFT TRUCKS & LOADERS
278964	28 1/4	21 15/16	3	JOHN DEERE	279568	17 3/8	17 7/16	3	LIFT TRUCKS & LOADERS
278968	29 3/4	30 3/8	3 3/4	JOHN DEERE	279569	17 1/2	18	3 3/4	LIFT TRUCKS & LOADERS
278976	19 3/8	19 1/8	3	DETROIT DIESEL	279573	17 1/2	16 5/16	3	LIFT TRUCKS & LOADERS
278977	35	34 5/16	4 1/2	DETROIT DIESEL	279575	17 3/4	19 1/8	2 1/4	LIFT TRUCKS & LOADERS
279042	42	50	5.25	OSHKOSH	279576	17 3/4	15 3/4	2 1/4	LIFT TRUCKS & LOADERS
279068	40	47 1/4	5 1/4	EUCLID	279577	17 3/4	19 1/8	2 1/4	LIFT TRUCKS & LOADERS
279070	44	53 7/16	4 1/2	EUCLID	279578	17 3/4	18	5 1/4	LIFT TRUCKS & LOADERS
279145	28 1/4	25 7/8	3 3/4	DETROIT DIESEL	279580	17 7/8	18 9/16	2 1/4	LIFT TRUCKS & LOADERS
279212	19 7/8	18 9/16	2 1/4	GALION	279581	18	19 1/8	3	LIFT TRUCKS & LOADERS
279213	22 1/2	23 1/16	3	GALION	279584	18	19 1/8	2 1/4	LIFT TRUCKS & LOADERS
279215	23	23 1/16	2 1/4	GALION	279586	18 1/8	22 1/2	3	LIFT TRUCKS & LOADERS
279216	23	23 1/16	3 3/4	GALION	279587	18 1/4	18	3 3/4	LIFT TRUCKS & LOADERS
279217	24 7/16	28 1/8	3	GALION	279591	18 1/2	19 1/8	3	LIFT TRUCKS & LOADERS
279218	25 3/4	25 5/16	3	GALION	279592	18 1/2	18 9/16	3 3/4	LIFT TRUCKS & LOADERS
279250	29 3/8	26 7/16	3	GRADALL	279593	18 5/8	21 3/8	3	LIFT TRUCKS & LOADERS
279259	18 1/8	19 1/8	3 3/4	HERCULES ENGINE	279600	19	19 1/8	3	LIFT TRUCKS & LOADERS
279282	25 3/4	25 5/16	3	INGERSOLL-RAND	279602	19	18	3 3/4	LIFT TRUCKS & LOADERS
279292	20 1/2	15 3/4	3	CASE/INTERNATIONAL	279603	19	22 1/2	3	LIFT TRUCKS & LOADERS
279297	16 3/4	17 7/16	3	INT'L HARVESTER	279615	19 1/4	20 13/16	3	LIFT TRUCKS & LOADERS
279298	17	17 7/16	3	INT'L HARVESTER	279617	19 3/8	18	2 1/4	LIFT TRUCKS & LOADERS
279299	17 1/2	16 5/16	2 1/4	INT'L HARVESTER	279618	19 3/8	19 1/8	3	LIFT TRUCKS & LOADERS
279307	20 1/4	16 5/16	3 3/4	INT'L HARVESTER	279620	19 3/8	16 7/8	5 1/4	LIFT TRUCKS & LOADERS

Vista-Pro Radiator Core Catalog

(Sort by Model)

Model #	Height	Width	Depth	Application	Model #	Height	Width	Depth	Application
279623	19 1/2	25 5/16	3 3/4	LIFT TRUCKS & LOADERS	281380	20 1/4	22 1/2	1 3/4	FORD TRUCK
279625	19 5/8	19 1/8	3	LIFT TRUCKS & LOADERS	281426	17 3/4	15 5/8	2 3/16	LIFT TRUCKS & LOADERS
279626	19 5/8	19 1/8	2 1/4	LIFT TRUCKS & LOADERS	281440	22 7/8	19 3/8	3	CASE/INTERNATIONAL
279632	19 3/4	19 1/8	2 1/4	LIFT TRUCKS & LOADERS	281445	17 1/2	18 1/8	2 15/16	JOHN DEERE
279634	20	13 1/2	3	LIFT TRUCKS & LOADERS	281456	22 3/8	22 1/2	2 1/4	MINNEAPOLIS MOLINE
279635	20 1/8	19 11/16	3	LIFT TRUCKS & LOADERS	281457	19 11/16	17 1/2	2 15/16	OLIVER HART PARR
279649	21	21 3/8	3	LIFT TRUCKS & LOADERS	281458	19 1/4	17 1/2	2 1/4	MINNEAPOLIS MOLINE
279657	22	19 11/16	3	LIFT TRUCKS & LOADERS	281461	21 3/16	19 3/8	2 1/4	MINNEAPOLIS MOLINE
279663	23	19 11/16	3	LIFT TRUCKS & LOADERS	281462	19	15	2 3/16	INT'L HARVESTER
279672	24	24 3/4	3	LIFT TRUCKS & LOADERS	281467	23	20 5/8	2 3/16	FIAT ALLIS
279675	24	23 5/8	3 3/4	LIFT TRUCKS & LOADERS	281479	16 9/16	16 7/8	2 3/16	MINNEAPOLIS MOLINE
279676	24 1/4	24 3/4	3 3/4	LIFT TRUCKS & LOADERS	281530	16 3/4	19 3/8	1 7/8	LINCOLN ELECTRIC
279677	24 3/8	24 3/4	3 3/4	LIFT TRUCKS & LOADERS	281536	16 1/4	19 3/8	2 1/4	LIFT TRUCKS & LOADERS
279681	25 1/8	25 5/16	2 1/4	LIFT TRUCKS & LOADERS	281541	13	15	4 7/16	LIFT TRUCKS & LOADERS
279691	27 3/8	24	6	LIFT TRUCKS & LOADERS	281551	19 1/8	18 1/8	2 1/4	GALION
279705	29 1/2	28 1/8	4 1/2	LIFT TRUCKS & LOADERS	281563	16 1/2	14 3/8	2 15/16	JOHN DEERE
279718	36 1/8	31 1/2	3 3/4	LIFT TRUCKS & LOADERS	281581	28 1/4	20 5/8	2 7/8	GMC
279721	37 1/2	37 11/16	5 1/4	LIFT TRUCKS & LOADERS	281589	31	25 5/8	2 15/16	NAVISTAR
279722	41 1/2	36	5 1/4	LIFT TRUCKS & LOADERS	281614	33 1/4	31 7/8	3 3/4	GMC
279733	20 1/2	18 9/16	2 1/4	LINCOLN ELECTRIC	281616	24 7/8	25	2 3/16	DETROIT DIESEL
279812	14 3/4	15 3/4	3	MASSEY-FERGUSON	281631	28 1/2	21 7/8	3 3/4	JOHN DEERE
279816	19 1/4	18	3	MASSEY-FERGUSON	281633	25	22 1/2	3 3/4	CASE/INTERNATIONAL
279818	21 7/8	18	3 3/4	MASSEY-FERGUSON	281647	22 1/2	25	2 1/4	JOHN DEERE
279819	22	17 7/16	3	MASSEY-FERGUSON	281648	22 1/4	23 1/8	3 11/16	DYNAHOE
279820	22	17 7/16	3 3/4	MASSEY-FERGUSON	281649	17 3/4	18 1/8	3	FORD POWER PRODUCTS
279821	23	24 3/16	3 3/4	MASSEY-FERGUSON	281651	50	50	4 7/16	DETROIT DIESEL
279845	20 1/2	17 7/16	2 1/4	MINNEAPOLIS MOLINE	281655	15 3/4	15 5/8	2 1/4	INT'L HARVESTER
279847	25 1/8	19 1/8	2 1/4	MINNEAPOLIS MOLINE	281659	19 1/8	20 5/8	2 1/4	LIFT TRUCKS & LOADERS
279850	26 3/8	25 1/2	3	FORD TRACTOR	281663	16 1/4	15 5/8	2 1/4	CASE/INTERNATIONAL
279855	17	16 5/16	3	OLIVER HART PARR	281664	16 5/8	19 3/8	2 15/16	LIFT TRUCKS & LOADERS
279860	20 3/4	18 9/16	2 1/4	OLIVER HART PARR	281666	25 3/4	27 1/2	3 11/16	LIFT TRUCKS & LOADERS
279861	21 1/4	18 9/16	2 1/4	OLIVER HART PARR	281678	27	35	3 3/4	LIFT TRUCKS & LOADERS
279898	19 1/4	18 9/16	3 3/4	REX	281699	19 3/8	18 3/4	2 15/16	FIAT ALLIS
279933	44	46 1/8	2 1/4	SULLAIR	281708	14 1/2	14 3/8	2 3/16	FIAT ALLIS
279947	14	25	4 1/2	TREE FARMER	281753	17 1/2	16 1/4	2 1/4	OLIVER HART PARR
279957	22 1/2	21 3/8	3	WAUKESHA	281755	17	16 1/4	2 15/16	OLIVER HART PARR
280081	17 3/4	14 3/8	2 1/4	JOHN DEERE	281807	16 7/8	16 7/8	2 3/16	JOHN DEERE
280144	17 1/2	15 5/8	2 3/16	MASSEY-FERGUSON	281827	17 5/8	17 1/2	3	FORD TRACTOR
280173	14 1/2	15 5/8	2 3/16	MONTGOMERY WARD	281828	17 5/8	18 1/8	2 1/4	MASSEY-FERGUSON
280180	30 1/2	26 1/4	3 3/4	DETROIT DIESEL	281833	45	45	3 11/16	INGERSOLL-RAND
280444	15 3/4	14 3/8	2 3/16	LIFT TRUCKS & LOADERS	281854	21	23 3/4	2 3/16	SULLAIR
280445	20	20	2 1/4	HOBART WELDER	281858	15	15	2 3/16	JOHN DEERE
280468	19 3/4	20 5/8	3	JOHN DEERE	281862	22 1/2	25	2 3/16	JOHN DEERE
280469	18 1/2	15 5/8	2 15/16	JOHN DEERE	281868	17 5/8	20 5/8	3	LIFT TRUCKS & LOADERS
280493	20 3/8	19 3/8	2 15/16	INT'L HARVESTER	281889	42	35	3	PETERBILT
280494	23 1/2	20 5/8	2 15/16	INT'L HARVESTER	281920	25 3/4	27 1/2	3 11/16	JOHN DEERE
280522	17	16 7/8	2 3/16	OLIVER HART PARR	281925	36 1/4	33 1/8	3 3/4	GMC
280551	36 1/4	34 3/8	1 1/2	PETERBILT	281931	34	45	4 7/16	SEAGRAVE
280613	20 1/8	21 1/4	3	INT'L HARVESTER	281935	20	16 7/8	2 1/4	JOHN DEERE
280655	21 1/2	18 3/4	2 1/4	JOHN DEERE	281938	29	34 3/8	2 3/8	MACK TRUCKS
280900	19 5/8	18 1/8	2 1/4	OLIVER HART PARR	281940	18 3/8	18 1/8	3	MASSEY-FERGUSON
280908	23 3/8	20	2 15/16	INT'L HARVESTER	281962	42	49 3/8	4 7/16	TEREX
281061	20 1/2	15	3	CASE/INTERNATIONAL	281974	20 1/2	23 3/4	2 1/4	MASSEY-FERGUSON
281150	17 1/2	16 1/4	2 3/16	OLIVER HART PARR	281976	34	31 1/4	4 7/16	TEREX
281257	29	25 5/8	3 3/4	DETROIT DIESEL	281987	31 3/4	28 3/4	3 11/16	MASSEY-FERGUSON

Vista-Pro Radiator Core Catalog

(Sort by Model)

Model #	Height	Width	Depth	Application	Model #	Height	Width	Depth	Application
282061	21	16 7/8	2 1/4	JOHN DEERE	282799	15 3/4	16 7/8	2 1/4	LIFT TRUCKS & LOADERS
282090	30	26 7/8	3 11/16	WAUKESHA	282970	22	26 1/4	6	TIMBER JACK
282110	20 1/4	22 1/2	1 3/4	FORD TRUCK	282972	20 3/4	18 1/8	3	FORD TRACTOR
282123	43 1/4	30 5/8	2 3/8	MACK TRUCKS	284010	42 3/4	27 15/16	2 1/4	NAVISTAR
282125	38 5/8	34 3/8	2 3/8	MACK TRUCKS	284015	39 3/4	30 3/16	2 1/4	NAVISTAR
282126	38 5/8	34 3/8	1 3/4	MACK TRUCKS	284020	30 3/8	34 3/4	2 1/4	MACK TRUCKS
282153	36 1/8	25 5/8	3 3/4	DETROIT DIESEL	284021	32 3/4	42 3/4	2 1/4	GMC
282170	45 3/8	36 7/8	4 7/16	FIAT ALLIS	284030	36 1/4	34 3/4	3	PETERBILT
282171	24 5/8	17 1/2	5 3/16	MOTOR COACH IND (MCI)	284035	39 7/8	28 1/2	2 1/4	NAVISTAR
282455	21 3/4	19 3/8	2 1/4	LIFT TRUCKS & LOADERS	284040	34	34 3/4	3	WESTERN STAR
282458	33 1/4	31 1/4	3 3/4	AMC	284045	29 5/16	39 7/8	2 1/4	MACK TRUCKS
282474	27 1/2	25	3	CASE/INTERNATIONAL	284050	29 5/16	39 7/8	3	MACK TRUCKS
282482	49 3/4	43 3/4	5 3/16	LINK-BELT	284055	40	29 1/16	2 1/4	KENWORTH
282489	24	19 3/8	3 3/4	FORD TRACTOR	284060	34	34 3/4	3	WESTERN STAR
282499	56 1/8	36 1/4	6	MANITOWOC	284065	36 1/4	34 3/4	2 1/4	PETERBILT
282564	41 1/2	20	6	JOHN DEERE	284070	37 7/8	27 3/8	2 1/4	FORD TRUCK
282571	26 3/4	21 7/8	3	JOHN DEERE	284075	29	34 3/4	2 1/4	MACK TRUCKS
282573	24	17 1/2	5 3/16	MOTOR COACH IND (MCI)	284078	39 3/4	30 3/16	3	NAVISTAR
282579	34 5/8	34 3/8	4 7/16	KOMATSU	284080	40	28 1/2	2 1/4	KENWORTH
282586	22 5/8	25	2 3/16	PETTIBONE	284085	35	41 1/16	3	KENWORTH
282591	21 3/4	26 1/4	2 15/16	LIFT TRUCKS & LOADERS	284090	37 1/2	38 3/4	3	PETERBILT
282597	26 1/4	23 1/8	4 7/16	LIFT TRUCKS & LOADERS	284095	32 3/4	29 1/16	2 1/4	KENWORTH
282652	15 3/8	19 3/8	2 15/16	LIFT TRUCKS & LOADERS	284100	57 7/8	60	5 3/16	CAT-LeMASTER
282655	27 1/4	20	3 11/16	OLIVER HART PARR	284102	43 3/4	43 3/4	5 3/16	CAT-LeMASTER
282657	27 3/8	24 3/8	3	CASE/INTERNATIONAL	284104	43 3/4	47 1/2	5 3/16	CAT-LeMASTER
282661	22 1/8	21 1/4	3 3/4	WHITE TRACTOR	284110	50 3/4	52 1/2	5 3/16	CAT-LeMASTER
282665	16 7/8	18 1/8	4 7/16	LIFT TRUCKS & LOADERS	284116	57 7/8	60	5 3/16	CAT-LeMASTER
282667	24 3/4	11 1/4	3 11/16	LIFT TRUCKS & LOADERS	284122	39 3/16	31 7/8	5 3/16	CAT-LeMASTER
282679	34	35	4 7/16	KOEHRING	284130	39 3/16	36 7/8	5 3/16	CAT-LeMASTER
282682	45	30	6	GARDNER DENVER	284132	33 7/8	35 5/8	5 3/16	CAT-LeMASTER
282683	28 5/8	35 5/8	3 11/16	OSHKOSH	284136	50 3/4	52 1/2	5 3/16	CAT-LeMASTER
282692	26	24 3/8	3 11/16	LIFT TRUCKS & LOADERS	284140	32 3/8	31 1/4	4 7/16	CAT-LeMASTER
282696	35	29 3/8	4 7/16	LINK-BELT	284142	39 3/16	36 7/8	5 3/16	CAT-LeMASTER
282700	43 1/2	48 1/8	4 7/16	OSHKOSH	284144	36 1/8	32 1/2	5 3/16	CAT-LeMASTER
282707	14 3/4	16 1/4	3 3/4	LIFT TRUCKS & LOADERS	284146	39 3/16	31 7/8	5 3/16	CAT-LeMASTER
282709	48 1/2	36 7/8	5 3/16	LIFT TRUCKS & LOADERS	284148	29 1/8	31 7/8	5 3/16	CAT-LeMASTER
282714	14 7/8	16 7/8	1 7/8	KUBOTA TRACTOR	284150	40 3/4	35	5 3/16	CAT-LeMASTER
282716	29 5/8	25	2 15/16	JOHN DEERE	284152	43 3/4	47 1/2	5 3/16	CAT-LeMASTER
282720	42	36 1/4	4 7/16	KOEHRING	284154	36 1/8	35	5 3/16	CAT-LeMASTER
282723	28	47 1/2	3 11/16	EUCLID	284156	39 3/16	38 1/8	5 3/16	CAT-LeMASTER
282726	45 3/8	43 3/4	5 3/16	LIFT TRUCKS & LOADERS	284158	50 3/4	50 5/8	5 3/16	CAT-LeMASTER
282733	13 1/8	19 3/8	2 1/4	LIFT TRUCKS & LOADERS	284162	43 3/4	43 3/4	5 3/16	CAT-LeMASTER
282740	18 3/4	20	3 11/16	LIFT TRUCKS & LOADERS	284164	43 3/4	43 3/4	5 3/16	CAT-LeMASTER
282741	32	31 1/4	4 7/16	FIAT ALLIS	284166	40 3/4	38 3/4	5 3/16	CAT-LeMASTER
282744	21 1/4	22 1/2	2 15/16	LIFT TRUCKS & LOADERS	284168	58	55 5/8	5 3/16	CAT-LeMASTER
282747	27 1/4	25	3 11/16	JOHN DEERE	284170	29 1/8	25	4 7/16	CAT-LeMASTER
282757	32	30	4 7/16	SEAGRAVE	284172	29 1/8	28 3/4	4 7/16	CAT-LeMASTER
282761	19 3/4	18 1/8	3 3/4	LIFT TRUCKS & LOADERS	284174	43 3/4	42 1/2	5 3/16	CAT-LeMASTER
282767	24 3/4	21 7/8	3 3/4	FORD TRACTOR	284180	39 3/16	36 7/8	5 3/16	CAT-LeMASTER
282769	34 1/2	19 3/8	3	JOHN DEERE	284182	29 1/8	31 7/8	5 3/16	CAT-LeMASTER
282770	28 3/8	26 1/4	4 7/16	LIFT TRUCKS & LOADERS	284184	36 1/8	35	5 3/16	CAT-LeMASTER
282776	19 3/4	21 7/8	2 15/16	LIFT TRUCKS & LOADERS	284186	61 3/4	62 1/2	5 3/16	CAT-LeMASTER
282777	23 1/4	21 1/4	2 15/16	JOHN DEERE	284192	39 3/16	31 7/8	5 3/16	CAT-LeMASTER
282787	13 7/8	15	2 1/4	LIFT TRUCKS & LOADERS	284194	39 3/16	36 7/8	5 3/16	CAT-LeMASTER
282796	17 3/4	18 1/8	3	LIFT TRUCKS & LOADERS	284200	39 3/16	44 3/8	5 3/16	CAT-LeMASTER

Vista-Pro Radiator Core Catalog

(Sort by Model)

Model #	Height	Width	Depth	Application	Model #	Height	Width	Depth	Application
284210	30 7/8	26 7/8	4 7/16	CAT-LeMASTER	284841	29 5/16	39 7/8	1 1/2	MACK TRUCKS
284220	39 3/16	36 7/8	5 3/16	CAT-LeMASTER	285000	21	21 7/8	2 3/16	FIAT ALLIS
284222	29 1/8	25	4 7/16	CAT-LeMASTER	285001	23	25	3 11/16	FIAT ALLIS
284224	40 3/4	43 1/8	5 3/16	CAT-LeMASTER	285027	25 1/2	25	3 11/16	FIAT ALLIS
284228	43 3/4	42 1/2	5 3/16	CAT-LeMASTER	285062	32 1/4	26 7/8	3 11/16	DRESSER INDUSTRIES
284232	43 3/4	47 1/2	5 3/16	CAT-LeMASTER	285097	24	20 5/8	4 7/16	INT'L HARVESTER
284238	43 3/4	47 1/2	5 3/16	CAT-LeMASTER	285099	27 3/4	20 5/8	4 7/16	DRESSER INDUSTRIES
284240	24 11/16	26 1/4	4 7/16	CAT-LeMASTER	285112	29 1/2	28 3/4	4 7/16	INT'L HARVESTER
284254	39 3/16	31 7/8	5 3/16	CAT-LeMASTER	285150	45	30 5/8	4 7/16	KOMATSU
284256	69 3/8	78 3/4	5 3/16	CAT-LeMASTER	285151	40	27 1/2	5 3/16	KOMATSU
284264	57 7/8	60	5 3/16	CAT-LeMASTER	285190	35	46 1/4	6	JOHN DEERE
284268	39 3/16	42 1/2	5 3/16	CAT-LeMASTER	285209	54 1/2	54 3/8	4 7/16	INGERSOLL-RAND
284270	43 3/4	50 5/8	5 3/16	CAT-LeMASTER	285215	32 7/8	36 1/4	4 7/16	LeTOURNEAU
284272	43 3/4	45 5/8	5 3/16	CAT-LeMASTER	285216	40 3/16	36 7/8	3 11/16	DRESSER INDUSTRIES
284274	39 3/16	37 1/2	5 3/16	CAT-LeMASTER	285221	42 7/8	42 1/2	5 3/16	V.M.E.
284276	50 3/4	50 5/8	5 3/16	CAT-LeMASTER	285224	45	44 3/8	5 3/16	KOMATSU
284280	43 3/4	43 1/8	5 3/16	CAT-LeMASTER	286334	15 1/4	19 3/8	2 15/16	LIFT TRUCKS & LOADERS
284282	50 3/4	51 7/8	5 3/16	CAT-LeMASTER	286342	59	55 5/8	5 3/16	LIFT TRUCKS & LOADERS
284298	40 3/4	34 3/8	5 3/16	CAT-LeMASTER	286360	21 1/4	18 3/4	2 3/16	OLIVER HART PARR
284305	39 7/8	28 1/2	3	NAVISTAR	286362	23 1/8	20 5/8	2 3/16	OLIVER HART PARR
284315	39 7/8	35 15/16	2 1/4	NAVISTAR	286363	23 1/8	20	2 15/16	OLIVER HART PARR
284337	43 1/4	33 1/16	2 1/4	FORD TRUCK	286364	27	20 5/8	3	OLIVER HART PARR
284519	32 3/4	29 1/16	3	KENWORTH	286375	30	28 1/8	3 3/4	PETERBILT
284531	32 1/2	34 3/4	2 1/4	WESTERN STAR	286376	13 3/4	19 3/8	2 1/4	LIFT TRUCKS & LOADERS
284626	40	28 1/2	3	KENWORTH	286380	15 3/4	19 3/8	2 1/4	LIFT TRUCKS & LOADERS
284628	38 5/8	34 3/16	3	MACK TRUCKS	286381	16	16 7/8	2 15/16	LIFT TRUCKS & LOADERS
284629	38 5/8	34 3/16	2 1/4	MACK TRUCKS	286382	16	17 1/2	2 1/4	LIFT TRUCKS & LOADERS
284631	37	32 1/2	2 1/4	FREIGHTLINER	286383	16	16 7/8	2 3/16	LIFT TRUCKS & LOADERS
284632	37	32 1/2	3	FREIGHTLINER	286397	25 1/4	26 1/4	2 1/4	LIFT TRUCKS & LOADERS
284646	36 1/4	34 3/4	3	PETERBILT	286400	24	29 3/8	3 11/16	FIAT ALLIS
284647	37	31 3/8	2 1/4	FREIGHTLINER	286402	27 1/2	21 1/4	3	JOHN DEERE
284648	37	32 1/2	3	FREIGHTLINER	286416	14 3/4	16 1/4	3	TORO
284653	40	29 1/16	3	KENWORTH	286450	37 1/2	38 3/4	3 3/4	PETERBILT
284688	37 7/8	27 3/8	2 1/4	FORD TRUCK	286463	24 1/2	19 3/8	2 15/16	JOHN DEERE
284690	38	34 3/4	3	VOLVO	286466	24 5/16	26 1/4	2 15/16	FORD TRUCK
284691	38	34 3/4	2 1/4	VOLVO	286471	14 5/8	19 3/8	2 1/4	LIFT TRUCKS & LOADERS
284692	39 7/8	35 15/16	3	NAVISTAR	286472	11 1/2	19 3/8	2 1/4	LIFT TRUCKS & LOADERS
284693	39 7/8	27 5/16	2 1/4	NAVISTAR	286497	37 1/4	37 1/2	4 7/16	DRESSER INDUSTRIES
284694	32 3/16	26 1/4	3	NAVISTAR	286499	17 3/4	18 1/8	4 7/16	LIFT TRUCKS & LOADERS
284696	37 1/2	28 1/2	3	PETERBILT	286508	22	17 1/2	3 3/4	MASSEY-FERGUSON
284697	37 1/4	30 3/4	2 1/4	MACK TRUCKS	286516	19 3/8	16 7/8	4 7/16	LIFT TRUCKS & LOADERS
284703	39 7/8	28 1/2	3	NAVISTAR	286518	30	28 3/4	4 7/16	FIAT ALLIS
284708	36 1/4	34 3/4	2 1/4	PETERBILT	286519	44 1/2	42 1/2	4 7/16	FIAT ALLIS
284709	44	27 3/8	3	GMC	286520	19	23 1/8	3	CASE/INTERNATIONAL
284715	42 3/4	27 15/16	3	NAVISTAR	286524	24	36 7/8	3	JOHN DEERE
284718	30 3/8	34 3/4	3	MACK TRUCKS	286528	17 1/4	19 3/8	1 7/8	DETROIT DIESEL
284719	37 7/8	27 3/8	3	FORD TRUCK	286531	16 1/8	19 3/8	2 3/16	LIFT TRUCKS & LOADERS
284722	37 7/8	27 3/8	1 1/2	FORD TRUCK	286537	19 1/4	18 3/4	3	CASE/INTERNATIONAL
284723	43 1/4	33 1/16	2 1/4	FORD TRUCK	286544	26 1/2	20 5/8	2 15/16	JOHN DEERE
284724	38 5/8	34 3/16	3	MACK TRUCKS	286549	14 3/4	19 3/8	2 15/16	LIFT TRUCKS & LOADERS
284740	39 3/4	30 3/16	3	NAVISTAR	286554	60	61 1/4	4 7/16	DETROIT DIESEL
284749	31 3/4	40 1/2	2 1/4	VOLVO	286559	22 1/2	23 1/8	3	GALION
284804	39 3/4	30 3/16	2 1/4	NAVISTAR	286560	23	23 1/8	3	GALION
284808	32 3/4	29 1/16	3	KENWORTH	286563	32 1/2	27 1/2	2 15/16	GALION
284826	37 5/8	25 1/16	2 1/4	NAVISTAR	286568	26 7/8	28 3/4	4 7/16	GROVE WORLDWIDE

Vista-Pro Radiator Core Catalog

(Sort by Model)

Model #	Height	Width	Depth	Application	Model #	Height	Width	Depth	Application
286569	28 1/2	27 1/2	4 7/16	GROVE WORLDWIDE	286917	22 1/2	25	3 3/4	CASE/INTERNATIONAL
286576	16	17 1/2	2 15/16	LIFT TRUCKS & LOADERS	286925	23 1/4	27 1/2	2 3/16	FORD TRUCK
286580	20	13 3/4	2 15/16	LIFT TRUCKS & LOADERS	286926	29	27 1/2	2 3/16	FORD TRUCK
286586	27 5/8	25	2 15/16	LIFT TRUCKS & LOADERS	286945	16 1/2	17 1/2	2 3/16	LIFT TRUCKS & LOADERS
286597	17	17 1/2	3	INT'L HARVESTER	286948	20 1/4	26 1/4	4 7/16	LIFT TRUCKS & LOADERS
286598	20 3/4	21 1/4	3	LIFT TRUCKS & LOADERS	286950	22 3/8	23 1/8	3	LIFT TRUCKS & LOADERS
286600	21	23 1/8	3 11/16	LIFT TRUCKS & LOADERS	286952	29 1/2	29 3/8	5 3/16	LIFT TRUCKS & LOADERS
286611	19 1/4	18 1/8	2 3/16	MASSEY-FERGUSON	286953	28 1/2	28 1/8	2 15/16	OSHKOSH
286613	20 3/4	18 3/4	2 3/16	OLIVER HART PARR	286955	30	27 1/2	4 7/16	PETTIBONE
286618	17 3/4	19 3/8	2 1/4	LIFT TRUCKS & LOADERS	286966	29 1/8	25 5/8	3 3/4	JOHN DEERE
286619	18	19 3/8	2 15/16	LIFT TRUCKS & LOADERS	286967	24 1/4	26 1/4	2 15/16	NAVISTAR
286623	12 3/4	19 3/8	2 3/16	LIFT TRUCKS & LOADERS	286971	37 5/8	34 3/8	3 3/4	MASSEY-FERGUSON
286629	21 1/2	21 1/4	3	WAUKESHA	286982	28 3/4	21 7/8	3 3/4	JOHN DEERE
286631	14	24 3/8	2 15/16	TIMBER JACK	286984	21 1/4	18 1/8	3 3/4	FORD TRACTOR
286635	17 1/2	18 1/8	3 3/4	LIFT TRUCKS & LOADERS	286996	30	28 1/8	4 7/16	PETERBILT
286636	15 3/4	16 1/4	3 3/4	LIFT TRUCKS & LOADERS	287094	23	24 3/8	3	FIAT ALLIS
286637	15 1/4	19 3/8	2 1/4	LIFT TRUCKS & LOADERS	287188	24 1/2	28 3/4	2 15/16	DRESSER INDUSTRIES
286640	21 3/4	13 3/4	2 15/16	JOHN DEERE	287217	17	16 1/4	2 15/16	OLIVER HART PARR
286641	20	18 3/4	3	JOHN DEERE	287224	19 1/2	19 3/8	2 1/4	DETROIT DIESEL
286642	19 7/8	18 1/8	4 7/16	JOHN DEERE	287243	13 7/8	13 3/4	2 3/16	MASSEY-FERGUSON
286649	28 7/8	28 3/4	5 3/16	STEIGER TRACTOR	287288	21 1/2	20	3	JOHN DEERE
286659	22 3/8	25	3 3/4	JOHN DEERE	287295	22 1/2	21 7/8	3 11/16	OLIVER HART PARR
286662	20	23 1/8	3 11/16	FIAT ALLIS	287356	17	19 3/8	2 1/4	LIFT TRUCKS & LOADERS
286664	37 1/2	28 1/8	5 3/16	PETERBILT	287398	26 3/8	22 1/2	2 1/4	LIFT TRUCKS & LOADERS
286702	29 3/4	30	3 11/16	LIFT TRUCKS & LOADERS	287458	18 3/4	16 7/8	2 1/4	FORD TRACTOR
286715	24 5/8	26 1/4	3	FIAT ALLIS	287465	21 3/8	19 3/8	2 3/16	MINNEAPOLIS MOLINE
286716	24 1/2	26 1/4	3 11/16	FIAT ALLIS	287494	21 3/4	18 1/8	2 15/16	LIFT TRUCKS & LOADERS
286717	25 1/8	26 1/4	3	CATERPILLAR	287512	17 1/2	16 1/4	2 15/16	FORD POWER PRODUCTS
286727	21 1/8	19 3/8	3	LIFT TRUCKS & LOADERS	287520	18 1/8	16 1/4	2 15/16	INT'L HARVESTER
286732	30 1/4	26 1/4	2 15/16	FORD TRUCK	287529	18 1/4	19 3/8	2 1/4	LIFT TRUCKS & LOADERS
286756	23	27 1/2	4 7/16	JOHN DEERE	287530	16 1/4	16 1/4	2 1/4	INT'L HARVESTER
286758	27 7/8	28 1/8	3 3/4	GROVE WORLDWIDE	287559	19	19 3/8	2 3/16	LINCOLN ELECTRIC
286764	24	19 3/8	2 15/16	FORD TRACTOR	287561	21	16 7/8	2 15/16	JOHN DEERE
286768	17 1/8	18 3/4	4 7/16	LIFT TRUCKS & LOADERS	287564	25 3/8	35 5/8	3 11/16	EUCLID
286781	13 7/8	17 1/2	3	LIFT TRUCKS & LOADERS	287588	32	26 1/4	4 7/16	OSHKOSH
286785	23 3/4	23 1/8	3	SPEED SPRAYER	287640	17 3/4	18 3/4	2 15/16	FIAT ALLIS
286786	16 1/2	17 1/2	2 1/4	LIFT TRUCKS & LOADERS	287685	17	15	2 1/4	JOHN DEERE
286798	36 1/2	28 3/4	3 11/16	TEREX	287688	20 1/2	20 5/8	2 15/16	FORD TRACTOR
286816	26 9/16	29 3/8	5 3/16	EMD LOCOMOTIVE	287702	21	20 5/8	2 15/16	LIFT TRUCKS & LOADERS
286828	39	26 7/8	2 3/8	MACK TRUCKS	287721	23 1/4	18 3/4	3 11/16	INT'L HARVESTER
286856	48	37 1/2	5 3/16	MANITOWOC	287736	20 1/4	18 3/4	2 3/16	GALION
286860	16	14 3/8	2 1/4	LIFT TRUCKS & LOADERS	287742	21 3/8	19 3/8	2 3/16	LINCOLN ELECTRIC
286861	18	17 1/2	2 1/4	CASE/INTERNATIONAL	287750	19 1/16	18 1/8	2 3/16	MASSEY-FERGUSON
286871	25 1/4	25	2 15/16	LIFT TRUCKS & LOADERS	287760	19 3/8	16 7/8	2 3/16	MINNEAPOLIS MOLINE
286872	22 1/2	23 1/8	3	GALION	287777	20 3/4	20 5/8	2 1/4	LIFT TRUCKS & LOADERS
286874	15 1/2	25	3 3/4	TIMBER JACK	287811	18 3/8	18 1/8	1 7/8	FIAT ALLIS
286878	24 1/4	26 1/4	2 3/8	FORD TRUCK	287863	17 3/4	15 5/8	2 1/4	CASE/INTERNATIONAL
286883	20 1/2	19 3/8	2 15/16	FORD POWER PRODUCTS	287947	14 3/4	13 3/4	2 1/4	FORD TRACTOR
286885	15 3/4	17 1/2	2 15/16	LIFT TRUCKS & LOADERS	287948	15 1/2	14 3/8	3	JOHN DEERE
286895	34 1/4	27 1/2	3 11/16	JOHN DEERE	287963	28	28 3/4	4 7/16	EUCLID
286901	15 3/4	16 7/8	2 1/4	LIFT TRUCKS & LOADERS	287991	40 3/4	36 1/4	4 7/16	GENERAL ELECTRIC
286907	16 7/8	19 3/8	2 3/16	LIFT TRUCKS & LOADERS	288000	17 1/2	16 1/4	3	FORD POWER PRODUCTS
286909	22 3/4	21 7/8	2 15/16	WAUKESHA	288021	19 3/8	18 1/8	2 15/16	LIFT TRUCKS & LOADERS
286911	18	17 1/2	5 3/16	LIFT TRUCKS & LOADERS	288030	15 1/2	18 3/4	2 15/16	LIFT TRUCKS & LOADERS
286912	19 3/8	19 3/8	3	LIFT TRUCKS & LOADERS	288032	15 1/2	18 3/4	2 3/16	LIFT TRUCKS & LOADERS

Vista-Pro Radiator Core Catalog

(Sort by Model)

Model #	Height	Width	Depth	Application	Model #	Height	Width	Depth	Application
288040	23 1/2	20 5/8	2 15/16	LIFT TRUCKS & LOADERS	289050	16 5/8	19 3/8	2 3/16	LIFT TRUCKS & LOADERS
288093	19 1/8	18 1/8	2 1/4	JOHN DEERE	289054	19 5/8	19 3/8	2 15/16	LIFT TRUCKS & LOADERS
288095	21 1/2	23 3/4	2 1/4	JOHN DEERE	289055	19 1/2	25 5/8	3 3/4	LIFT TRUCKS & LOADERS
288123	16	16 7/8	2 3/16	LIFT TRUCKS & LOADERS	289058	20	18 3/4	2 3/16	JOHN DEERE
288142	16 7/8	15 5/8	2 1/4	OLIVER HART PARR	289083	24 7/8	26 1/4	3 11/16	FIAT ALLIS
288164	19 1/4	18 1/8	2 3/16	MINNEAPOLIS MOLINE	289087	16 7/8	21 1/4	2 1/4	CASE/INTERNATIONAL
288183	16 1/8	15 5/8	2 1/4	INT'L HARVESTER	289122	23	25	3 11/16	LIFT TRUCKS & LOADERS
288192	25 1/8	19 3/8	3 3/4	INT'L HARVESTER	289125	31 1/8	37 1/2	4 7/16	F.W.D.
288197	19 1/8	19 3/8	2 1/4	WAUKESHA	289130	22 1/2	18 1/8	3	JOHN DEERE
288223	22 5/8	18 3/4	2 1/4	INT'L HARVESTER	289132	25 1/4	35 5/8	4 7/16	EUCLID
288224	16 1/8	16 1/4	2 15/16	LIFT TRUCKS & LOADERS	289153	19 7/8	18 1/8	2 1/4	GALION
288259	37	37 1/2	5 3/16	HAPPY YOUNG	289159	23 1/4	22 1/2	3	FORD POWER PRODUCTS
288291	27 7/8	26 7/8	3	MINNEAPOLIS MOLINE	289161	21 5/8	23 1/8	2 3/16	SULLAIR
288305	21 1/2	19 3/8	1 7/8	JOHN DEERE	289162	16	16 1/4	2 15/16	LIFT TRUCKS & LOADERS
288307	16 1/4	19 3/8	2 1/4	LIFT TRUCKS & LOADERS	289166	26 1/4	18 1/8	3 3/4	CASE/INTERNATIONAL
288402	17 1/2	16 1/4	2 1/4	FORD TRACTOR	289169	19 5/8	17 1/2	3	LIFT TRUCKS & LOADERS
288417	21 1/2	19 3/8	2 1/4	MINNEAPOLIS MOLINE	289170	27 3/4	21 1/4	3	JOHN DEERE
288418	14 7/8	19 3/8	2 15/16	LIFT TRUCKS & LOADERS	289173	16 3/4	26 1/4	5 3/16	PETTIBONE
288420	32	37 1/2	4 7/16	EAGLE COACH	289175	24	20	1 7/8	LeROI
288440	40	47 1/2	4 7/16	EUCLID	289176	16 3/4	17 1/2	2 15/16	INT'L HARVESTER
288441	18	23 3/4	1 7/8	FORD TRUCK	289178	21 1/2	18 3/4	3	OLIVER HART PARR
288469	27 5/16	10 5/8	2 1/4	GARDNER DENVER	289199	37	27 1/2	3 3/4	MACK TRUCKS
288472	41 5/8	41 1/4	4 7/16	DETROIT DIESEL	289210	14	25	4 7/16	TREE FARMER
288495	13 1/2	14 3/8	2 15/16	LIFT TRUCKS & LOADERS	289260	27 7/8	25 5/8	3	JOHN DEERE
288538	21	17 1/2	2 15/16	LIFT TRUCKS & LOADERS	289268	21 3/4	18 1/8	2 15/16	FIAT ALLIS
288561	22 1/2	18 1/8	3	JOHN DEERE	289269	19 5/8	19 3/8	2 3/16	LIFT TRUCKS & LOADERS
288562	15 1/2	14 3/8	2 1/4	JOHN DEERE	289270	19 1/4	17 1/2	3	LIFT TRUCKS & LOADERS
288582	18 1/2	19 3/8	2 15/16	ELGIN	289273	28 3/4	25 5/8	2 1/4	INT'L HARVESTER
288596	18 3/4	16 7/8	2 3/16	FORD TRACTOR	289322	23	28 3/4	3 11/16	FIAT ALLIS
288603	26 1/2	26 1/4	3	DETROIT DIESEL	289327	14 1/2	19 3/8	2 1/4	LIFT TRUCKS & LOADERS
288641	22 7/16	19 3/8	2 15/16	INT'L HARVESTER	289374	21 1/2	25	3 11/16	JOHN DEERE
288642	27 7/8	25 5/8	2 3/16	JOHN DEERE	289375	15	16 1/4	3	INT'L HARVESTER
288677	18 7/8	19 3/8	3	MASSEY-FERGUSON	289376	17 1/2	16 1/4	3	INT'L HARVESTER
288681	25 3/4	22 1/2	3 3/4	LIFT TRUCKS & LOADERS	289410	22 5/8	19 3/8	4 7/16	JOHN DEERE
288685	18 3/4	15 5/8	2 3/16	MASSEY-FERGUSON	289420	25	21 1/4	3	JOHN DEERE
288694	22 3/8	22 1/2	3	MINNEAPOLIS MOLINE	289423	18	19 3/8	2 1/4	LIFT TRUCKS & LOADERS
288696	22 1/2	18 1/8	3	CASE/INTERNATIONAL	289424	18 1/4	23 1/8	3	FIAT ALLIS
288698	25	19 3/8	3	MINNEAPOLIS MOLINE	289429	22 3/4	9 3/8	3	CASE/INTERNATIONAL
288732	18 3/4	19 3/8	2 3/16	LIFT TRUCKS & LOADERS	289435	23	29 3/8	3 11/16	FIAT ALLIS
288777	21	20 5/8	2 1/4	LIFT TRUCKS & LOADERS	289439	21 3/4	25	2 15/16	LIFT TRUCKS & LOADERS
288805	43 7/8	36 1/4	5 3/16	LeTOURNEAU	289442	29	21 7/8	3	JOHN DEERE
288827	15 1/4	16 1/4	1 7/8	LIFT TRUCKS & LOADERS	289446	23 7/8	20 5/8	3	JOHN DEERE
288874	21 3/4	25	1 7/8	DODGE	289448	32 1/2	34 3/8	4 7/16	FIAT ALLIS
288892	29 7/8	30	4 7/16	MINNEAPOLIS MOLINE	289459	19 3/8	17 1/2	3	FIAT ALLIS
288902	36	32 1/2	4 7/16	WAUKESHA	289467	17 3/4	18 1/8	3 3/4	FORD TRACTOR
288923	25 1/8	19 3/8	2 1/4	MINNEAPOLIS MOLINE	289498	37 3/4	37 1/2	4 7/16	FIAT ALLIS
288927	44	47 1/2	4 7/16	EUCLID	289500	27 7/8	27 1/2	4 7/16	JOHN DEERE
289006	33	31 1/4	3 11/16	LIFT TRUCKS & LOADERS	289507	15 1/4	15 5/8	2 1/4	FIAT ALLIS
289037	15	19 3/8	3	LIFT TRUCKS & LOADERS	289517	24 1/2	27 1/2	3	JOHN DEERE
289039	17 1/8	22 1/2	2 15/16	LIFT TRUCKS & LOADERS	289522	25	23 1/8	3 3/4	FIAT ALLIS
289041	18 3/4	18 1/8	3	LIFT TRUCKS & LOADERS	289524	27	21 1/4	3	JOHN DEERE
289042	19 1/4	22 1/2	2 1/4	LIFT TRUCKS & LOADERS	289527	29 1/4	21 1/4	3 3/4	JOHN DEERE
289043	19 1/2	18 1/8	3 3/4	LIFT TRUCKS & LOADERS	289529	15 3/4	16 1/4	2 15/16	LIFT TRUCKS & LOADERS
289048	15 3/4	18 3/4	3	LIFT TRUCKS & LOADERS	289533	20	19 3/8	2 3/16	HOBART WELDER
289049	16 1/8	19 3/8	2 15/16	LIFT TRUCKS & LOADERS	289552	19	18 1/8	2 15/16	LIFT TRUCKS & LOADERS

Vista-Pro Radiator Core Catalog

(Sort by Model)

Model #	Height	Width	Depth	Application	Model #	Height	Width	Depth	Application
289563	30 1/4	29 3/8	3 3/4	TEREX	289981	29 3/8	26 1/4	2 15/16	GRADALL
289565	22 1/2	25	3	JOHN DEERE					
289570	48	37 1/2	4 7/16	MANITOWOC					
289577	16 1/4	14 3/8	2 3/16	DAVID BROWN TRACTOR					
289592	26 1/8	23 1/8	4 7/16	LIFT TRUCKS & LOADERS					
289594	21 1/8	23 1/8	3 3/4	DYNAHOE					
289602	32 1/2	27 1/2	3 3/4	GALION					
289615	24	36 7/8	3 3/4	JOHN DEERE					
289617	28	25 5/8	3	JOHN DEERE					
289629	17	24 3/8	3	LIFT TRUCKS & LOADERS					
289638	18 5/8	18 1/8	2 3/16	INT'L HARVESTER					
289651	29 3/4	30 5/8	3 3/4	JOHN DEERE					
289653	18 5/8	21 1/4	3	LIFT TRUCKS & LOADERS					
289700	23 3/4	22 1/2	3	CASE/INTERNATIONAL					
289747	24 3/8	26 1/4	2 3/8	FORD					
289756	27 3/8	28 3/4	3 3/4	LIMA					
289759	15 7/8	16 1/4	3	LIFT TRUCKS & LOADERS					
289760	15 3/4	15	2 15/16	LIFT TRUCKS & LOADERS					
289769	20 1/2	18 3/4	3	JOHN DEERE					
289777	40	32 1/2	5 3/16	LIFT TRUCKS & LOADERS					
289813	27 1/8	28 1/8	3 3/4	GROVE WORLDWIDE					
289825	18	19 3/8	2 15/16	LIFT TRUCKS & LOADERS					
289830	37 1/2	38 1/8	4 7/16	PETERBILT					
289843	21 7/8	18 1/8	3 11/16	MASSEY-FERGUSON					
289848	36	33 3/4	3 3/4	WAUKESHA					
289865	20	23 1/8	3 11/16	FIAT ALLIS					
289866	27 1/2	24 3/8	5 3/16	FIAT ALLIS					
289868	28 1/4	21 1/4	3	JOHN DEERE					
289869	44	53 3/4	4 7/16	EUCLID					
289875	23	24 3/8	3 3/4	MASSEY-FERGUSON					
289876	29	21 7/8	3 3/4	JOHN DEERE					
289877	50 3/4	35	4 7/16	WAUKESHA					
289882	16 1/2	17 1/2	3	LIFT TRUCKS & LOADERS					
289885	20 1/2	19 3/8	3	TREE FARMER					
289889	15	16 7/8	1 7/8	LIFT TRUCKS & LOADERS					
289890	15 3/4	19 3/8	2 1/4	LIFT TRUCKS & LOADERS					
289896	17 3/8	17 1/2	2 15/16	LIFT TRUCKS & LOADERS					
289897	18 3/4	21 7/8	2 3/16	LIFT TRUCKS & LOADERS					
289898	19 1/4	20 5/8	3	LIFT TRUCKS & LOADERS					
289899	19 3/8	18 1/8	2 3/16	LIFT TRUCKS & LOADERS					
289904	21	21 1/4	2 15/16	LIFT TRUCKS & LOADERS					
289906	23	25	4 7/16	LIFT TRUCKS & LOADERS					
289910	27 5/8	25	5 3/16	LIFT TRUCKS & LOADERS					
289921	19 5/8	20 5/8	2 1/4	LIFT TRUCKS & LOADERS					
289922	20 5/8	18 1/8	3	CASE/INTERNATIONAL					
289923	21 1/4	23 1/8	3	CASE/INTERNATIONAL					
289933	14 1/2	19 3/8	2 1/4	LIFT TRUCKS & LOADERS					
289936	19 3/8	18 3/4	3	LIFT TRUCKS & LOADERS					
289937	20 1/8	20	2 15/16	LIFT TRUCKS & LOADERS					
289956	19 1/2	23 1/8	3 3/4	DROTT					
289972	18 1/2	18 1/8	3 3/4	LIFT TRUCKS & LOADERS					
289974	15 3/4	17 1/2	3	LIFT TRUCKS & LOADERS					
289975	29 1/2	28 1/8	4 7/16	LIFT TRUCKS & LOADERS					
289977	26	28 1/8	2 1/4	LIFT TRUCKS & LOADERS					
289979	29 1/2	24 3/4	4.375	METRO BUS					

Branch and Plant Locations

State	City/Town	Watts Phone	Local Phone	Fax Number	Location Type
California	Sacramento	(800)933-7237	(916)649-8020	(916)649-3101	Branch
	San Bernardino	(800)776-4775	(909)796-0754	(909)796-1349	Branch/Plant
Colorado	Denver	(800)776-4630	(303)922-8481	(303)922-3465	Branch/Plant
Connecticut	Windsor	(800)755-2145	(860)688-7644	(860)683-0445	Branch/Plant
Florida	Orlando	(800)776-9596	(407)843-9130	(407)849-5215	Branch/Plant
	Pensacola	(800)776-0951	(850)477-6244	(850)478-3383	Branch/Agent
Georgia	Atlanta	(800)776-9575	(404)627-5731	(404)627-3153	Branch
Illinois	Burr Ridge	(800)755-2169	(630)655-2673	(630)655-2686	Branch/Plant
Mississippi	Southaven	(800)776-4925	(662)342-1848	(662)342-2433	Branch
Missouri	N. Kansas City	(800)776-4375	(816)471-1805	(816)421-0203	Branch
	St. Louis	(800)776-4410	(314)645-1900	(314)645-2501	Branch
Montana	Billings	(800)776-4979	(406)248-4394	(406)248-5194	Branch/Agent
Ohio	Cleveland	(800)776-4225	(216)267-8970	(216)267-2157	Branch/Plant
Oklahoma	Oklahoma City	(800)776-9635	(405)272-0453	(405)235-2020	Branch/Agent
Texas	Amarillo	(800)711-0784	(806)342-9440	(806)376-1571	Branch/Agent
	Corpus Christi	(800)529-7237	(361)854-4124	(361)854-4102	Branch
	Dallas	(800)776-9605	(214)637-2050	(214)638-1445	Branch/Plant
	Odessa	(800)776-4939	(432)337-0961	(432)337-1200	Branch/Agent
	San Antonio	(800)776-8042	(210)224-0857	(210)224-7320	Branch
Utah	Salt Lake City	(800)825-7237	(801)975-9688	(801)973-8768	Branch
Washington	Seattle	(800)776-4650	(206)764-7028	(206)764-9659	Branch/Plant

Heavy Duty Tech Hotline

800-799-7237

Customer Service

888-250-2676

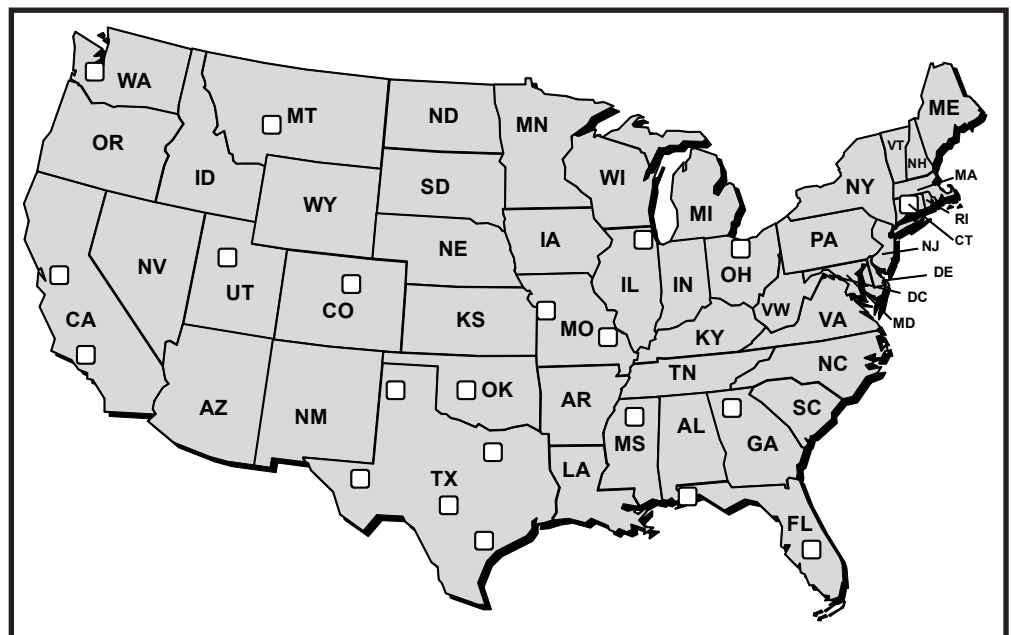

Our U.S. Branch locations



2010

Core Catalog

Flat fin and Serpentine cores
Cars, Trucks and Industrial Cores

Includes Header Gasket Listing

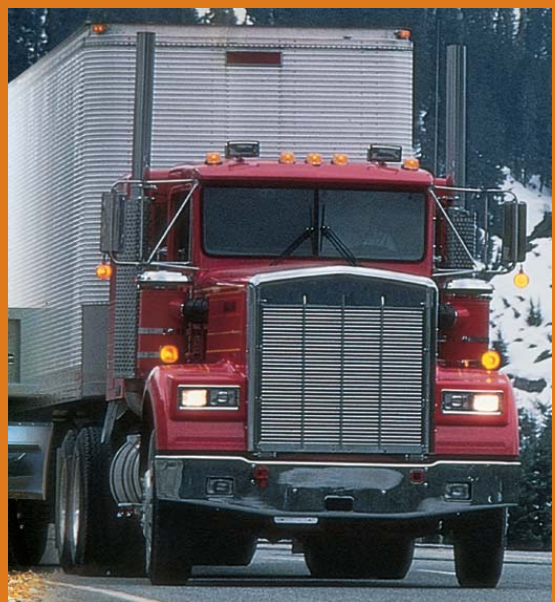



Heavy Duty Cores

Vista-Pro Automotive offers heavy duty radiator shops same-day and next-day service on thousands of replacement radiator core models. We can respond so quickly because we manufacture our own cores in eight regional plants throughout North America.

Customized, made-to-order cores are our specialty

We'll make your unique replacement core using simple dimensions with uncomplicated steps. Using our computerized core configurator and the dimensions you provide, we can create a shop drawing and provide a price quote within minutes.

Our core makers are experts in reproducing flat (or plate) fin cores in copper, brass or steel, with reinforcements as needed. Our capabilities include both $\frac{1}{2}$ " and $\frac{3}{4}$ " tubes, in addition to the latest copper serpentine louvered fins, for the best combination of heat transfer capacity and mechanical strength.

For next-day delivery, just call us before noon

Our Branch and plant locations are interconnected to provide quality, service, and the best coverage and price in the aftermarket.

For more information, call our Heavy Duty Tech Support line at: 800-799-7237.



Customer Service: 888-250-2676
Monday-Friday: 7:00 a.m.-7:00 p.m. CT

